



**THE DATASHEET OF
A2T27S020GNR1**





RF Power LDMOS Transistors

N-Channel Enhancement-Mode Lateral MOSFETs

These 2.5 W RF power LDMOS transistors are designed for cellular base station applications covering the frequency range of 400 to 2700 MHz.

- Typical Single-Carrier W-CDMA Performance: $V_{DD} = 28$ Vdc, $I_{DQ} = 185$ mA, $P_{out} = 2.5$ W Avg., Input Signal PAR = 9.9 dB @ 0.01% Probability on CCDF.(1)

1800 MHz

Frequency	G_{ps} (dB)	η_D (%)	Output PAR (dB)	ACPR (dBc)	IRL (dB)
1805 MHz	20.8	20.9	9.4	-44.6	-9
1840 MHz	21.1	20.9	9.3	-45.6	-16
1880 MHz	20.7	20.6	9.1	-45.5	-13

- Typical Single-Carrier W-CDMA Performance: $V_{DD} = 28$ Vdc, $I_{DQ} = 185$ mA, $P_{out} = 2.5$ W Avg., Input Signal PAR = 9.9 dB @ 0.01% Probability on CCDF.(1)

2100 MHz

Frequency	G_{ps} (dB)	η_D (%)	Output PAR (dB)	ACPR (dBc)	IRL (dB)
2110 MHz	19.5	20.1	9.3	-46.4	-10
2140 MHz	19.8	19.8	9.0	-45.0	-13
2170 MHz	19.7	20.1	8.9	-44.9	-11

2600 MHz

Frequency	G_{ps} (dB)	η_D (%)	Output PAR (dB)	ACPR (dBc)	IRL (dB)
2575 MHz	17.6	20.3	9.3	-44.2	-8
2605 MHz	18.6	20.4	9.0	-41.3	-10
2635 MHz	18.0	20.1	8.6	-40.7	-6

1. All data measured in fixture with device soldered to heatsink.

Features

- Greater negative gate-source voltage range for improved Class C operation
- Designed for digital predistortion error correction systems
- Universal broadband driver

A2T27S020NR1 A2T27S020GNR1

400–2700 MHz, 2.5 W AVG., 28 V
 AIRFAST RF POWER LDMOS
 TRANSISTORS

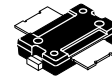

TO-270-2
 PLASTIC
 A2T27S020NR1

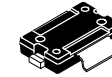

TO-270G-2
 PLASTIC
 A2T27S020GNR1

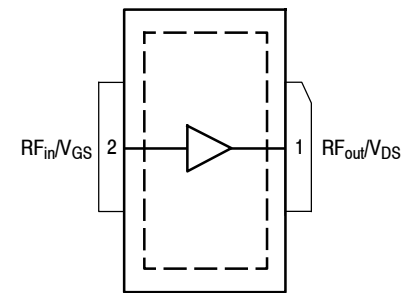

(Top View)

Note: The backside of the package is the source terminal for the transistor.

Figure 1. Pin Connections

Table 1. Maximum Ratings

Rating	Symbol	Value	Unit
Drain-Source Voltage	V_{DSS}	-0.5, +65	Vdc
Gate-Source Voltage	V_{GS}	-6.0, +10	Vdc
Operating Voltage	V_{DD}	32, +0	Vdc
Storage Temperature Range	T_{stg}	-65 to +150	°C
Case Operating Temperature Range	T_C	-40 to +150	°C
Operating Junction Temperature Range (1,2)	T_J	-40 to 225	°C

Table 2. Thermal Characteristics

Characteristic	Symbol	Value (2,3)	Unit
Thermal Resistance, Junction to Case Case Temperature 71.8°C, 2.5 W CW, 28 Vdc, $I_{DQ} = 185$ mA, 1842.5 MHz	$R_{\theta JC}$	1.6	°C/W

Table 3. ESD Protection Characteristics

Test Methodology	Class
Human Body Model (per JESD22-A114)	2
Charge Device Model (per JESD22-C101)	C3

Table 4. Moisture Sensitivity Level

Test Methodology	Rating	Package Peak Temperature	Unit
Per JESD22-A113, IPC/JEDEC J-STD-020	3	260	°C

Table 5. Electrical Characteristics ($T_A = 25^\circ\text{C}$ unless otherwise noted)

Characteristic	Symbol	Min	Typ	Max	Unit
Off Characteristics					
Zero Gate Voltage Drain Leakage Current ($V_{DS} = 65$ Vdc, $V_{GS} = 0$ Vdc)	I_{DSS}	—	—	10	μAdc
Zero Gate Voltage Drain Leakage Current ($V_{DS} = 32$ Vdc, $V_{GS} = 0$ Vdc)	I_{DSS}	—	—	1	μAdc
Gate-Source Leakage Current ($V_{GS} = 5$ Vdc, $V_{DS} = 0$ Vdc)	I_{GSS}	—	—	1	μAdc
On Characteristics					
Gate Threshold Voltage ($V_{DS} = 10$ Vdc, $I_D = 24.2$ μAdc)	$V_{GS(th)}$	0.8	1.2	1.6	Vdc
Gate Quiescent Voltage ($V_{DD} = 28$ Vdc, $I_D = 185$ mAdc, Measured in Functional Test)	$V_{GS(Q)}$	1.5	1.8	2.3	Vdc
Drain-Source On-Voltage ($V_{GS} = 10$ Vdc, $I_D = 242$ mAdc)	$V_{DS(on)}$	0	0.1	0.2	Vdc

1. Continuous use at maximum temperature will affect MTTF.
2. MTTF calculator available at <http://www.nxp.com/RF/calculators>.
3. Refer to AN1955, *Thermal Measurement Methodology of RF Power Amplifiers*. Go to <http://www.nxp.com/RF> and search for AN1955.

(continued)

Table 5. Electrical Characteristics ($T_A = 25^\circ\text{C}$ unless otherwise noted) (continued)

Characteristic	Symbol	Min	Typ	Max	Unit
Functional Tests (In NXP Test Fixture, 50 ohm system) $V_{DD} = 28\text{ Vdc}$, $I_{DQ} = 185\text{ mA}$, $P_{out} = 2.5\text{ W Avg.}$, $f = 1842.5\text{ MHz}$, Single-Carrier W-CDMA, IQ Magnitude Clipping, Input Signal PAR = 9.9 dB @ 0.01% Probability on CCDF. ACPR measured in 3.84 MHz Channel Bandwidth @ $\pm 5\text{ MHz}$ Offset.					
Power Gain	G_{ps}	20.0	21.0	23.0	dB
Drain Efficiency	η_D	19.4	20.8	—	%
Output Peak-to-Average Ratio @ 0.01% Probability on CCDF	PAR	8.8	9.2	—	dB
Adjacent Channel Power Ratio	ACPR	—	-45.3	-42.0	dBc
Input Return Loss	IRL	—	-17	-5	dB

Load Mismatch (In NXP Test Fixture, 50 ohm system) $I_{DQ} = 185\text{ mA}$, $f = 1842.5\text{ MHz}$

VSWR 10:1 at 32 Vdc, 28 W CW Output Power (3 dB Input Overdrive from 20 W CW Rated Power)	No Device Degradation
--	-----------------------

Typical Performance ⁽¹⁾ (In NXP Test Fixture, 50 ohm system) $V_{DD} = 28\text{ Vdc}$, $I_{DQ} = 185\text{ mA}$, 1805–1880 MHz Bandwidth

P_{out} @ 1 dB Compression Point, CW	P1dB	—	20	—	W
AM/PM (Maximum value measured at the P3dB compression point across the 1805–1880 MHz frequency range.)	Φ	—	-11	—	°
VBW Resonance Point (IMD Third Order Intermodulation Inflection Point)	VBW_{res}	—	100	—	MHz
Gain Flatness in 75 MHz Bandwidth @ $P_{out} = 2.5\text{ W Avg.}$	G_F	—	0.4	—	dB
Gain Variation over Temperature (-30°C to +85°C)	ΔG	—	0.012	—	dB/°C
Output Power Variation over Temperature (-30°C to +85°C)	$\Delta P1dB$	—	0.003	—	dB/°C

Table 6. Ordering Information

Device	Tape and Reel Information	Package
A2T27S020NR1	R1 Suffix = 500 Units, 24 mm Tape Width, 13-inch Reel	TO-270-2
A2T27S020GNR1		TO-270G-2

1. All data measured in fixture with device soldered to heatsink.

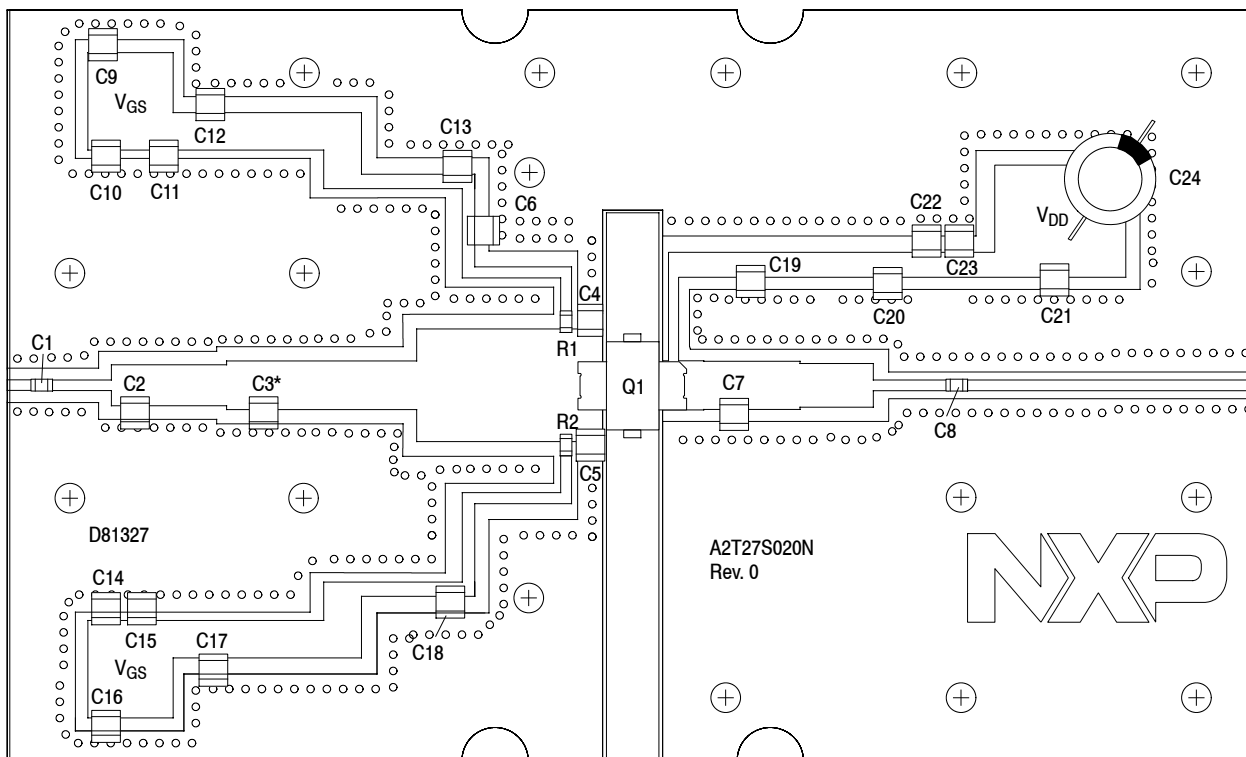

*C3 is mounted vertically.

Note: All data measured in fixture with device soldered to heatsink.

Figure 2. A2T27S020NR1 Test Circuit Component Layout — 1805–1880 MHz

Table 7. A2T27S020NR1 Test Circuit Component Designations and Values — 1805–1880 MHz

Part	Description	Part Number	Manufacturer
C1	1.8 pF Chip Capacitor	ATC600F1R8BT250XT	ATC
C2	1 pF Chip Capacitor	ATC100B1R0BT500XT	ATC
C3, C7	3 pF Chip Capacitor	ATC100B3R0CT500XT	ATC
C4, C5	2 pF Chip Capacitor	ATC100B2R0BT500XT	ATC
C6	6.8 pF Chip Capacitor	ATC600F6R8BT250XT	ATC
C8	2.4 pF Chip Capacitor	ATC600F2R4BT250XT	ATC
C9, C16	22 μ F, 35 V Tantalum Capacitor	T491X226K035AT	Kemet
C10, C14, C21	2.2 μ F Chip Capacitor	C1825C225J5RACTU	Kemet
C11, C15, C23	0.1 μ F Chip Capacitor	CDR33BX104AKWS	AVX
C12, C17, C22	220 nF Chip Capacitor	C1812C224K5RACTU	Kemet
C13, C18, C20	2.2 μ F Chip Capacitor	C3225X7R1H225K250AB	TDK
C19	6.8 pF Chip Capacitor	ATC100B6R8CT500XT	ATC
C24	470 μ F, 63 V Electrolytic Capacitor	MCGPR63V477M13X26-RH	Multicomp
Q1	RF Power LD MOS Transistor	A2T27S020N	NXP
R1, R2	2.2 Ω , 1/4 W Chip Resistor	CRCW12062R20JNEA	Vishay
PCB	Rogers RO4350B, 0.020", $\epsilon_r = 3.66$	D81327	Rogers

TYPICAL CHARACTERISTICS — 1805–1880 MHz

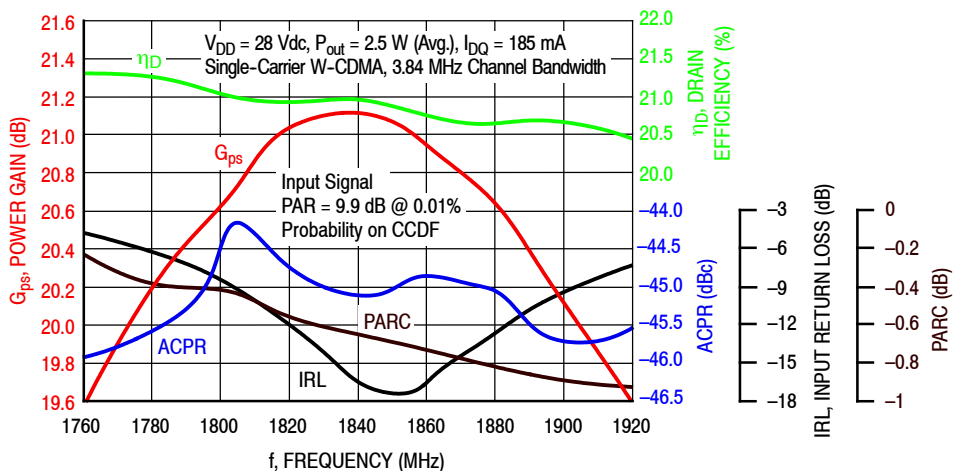

Figure 3. Single-Carrier Output Peak-to-Average Ratio Compression (PARC) Broadband Performance @ $P_{out} = 2.5$ Watts Avg.

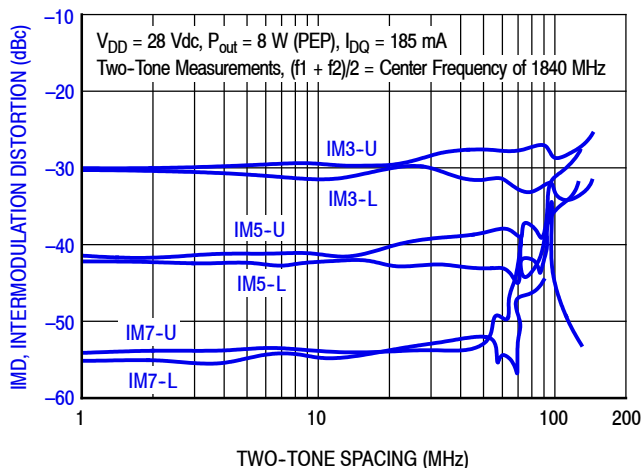

Figure 4. Intermodulation Distortion Products versus Two-Tone Spacing

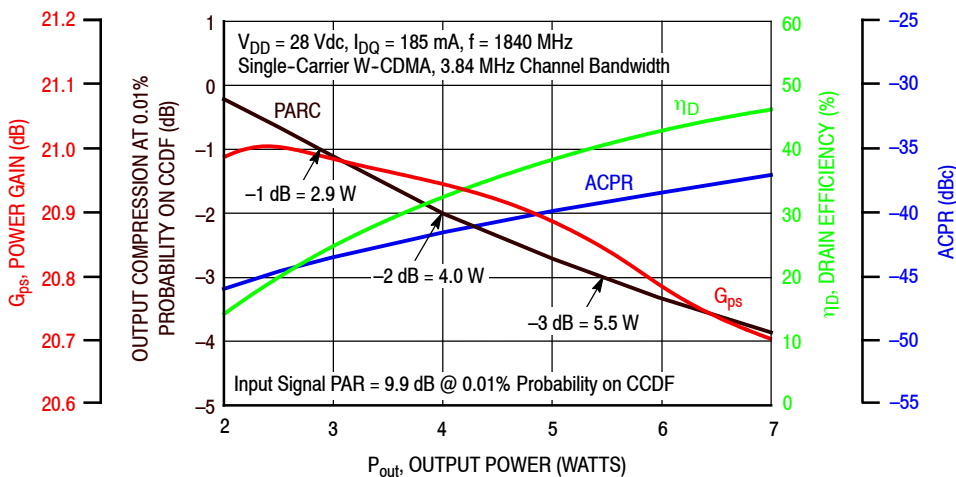

Figure 5. Output Peak-to-Average Ratio Compression (PARC) versus Output Power

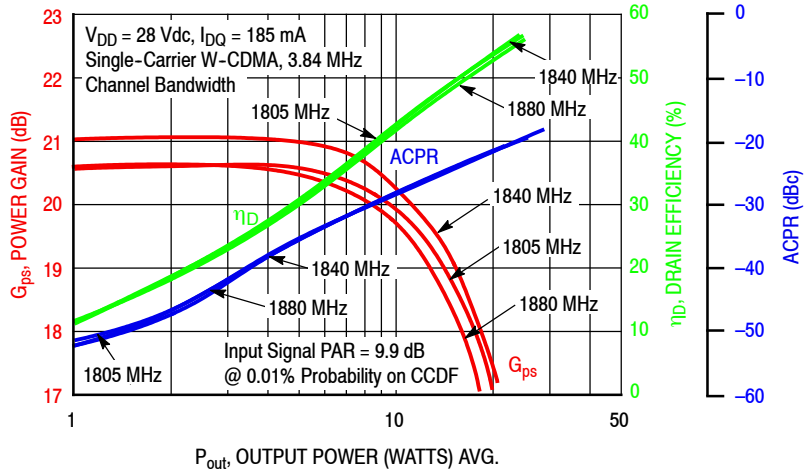

Figure 6. Single-Carrier W-CDMA Power Gain, Drain Efficiency and ACPR versus Output Power

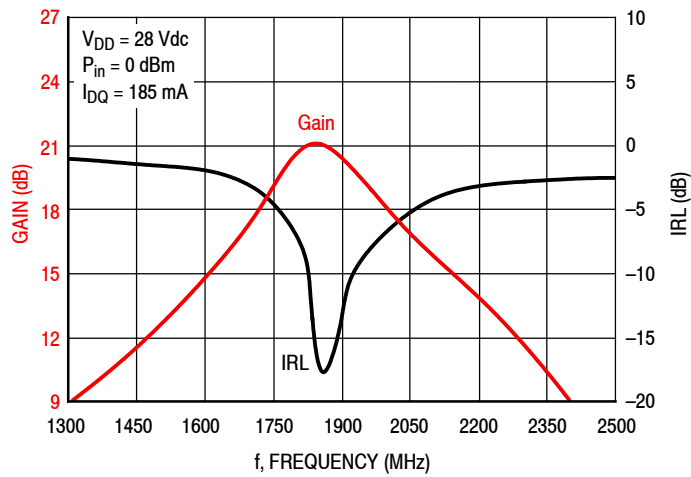
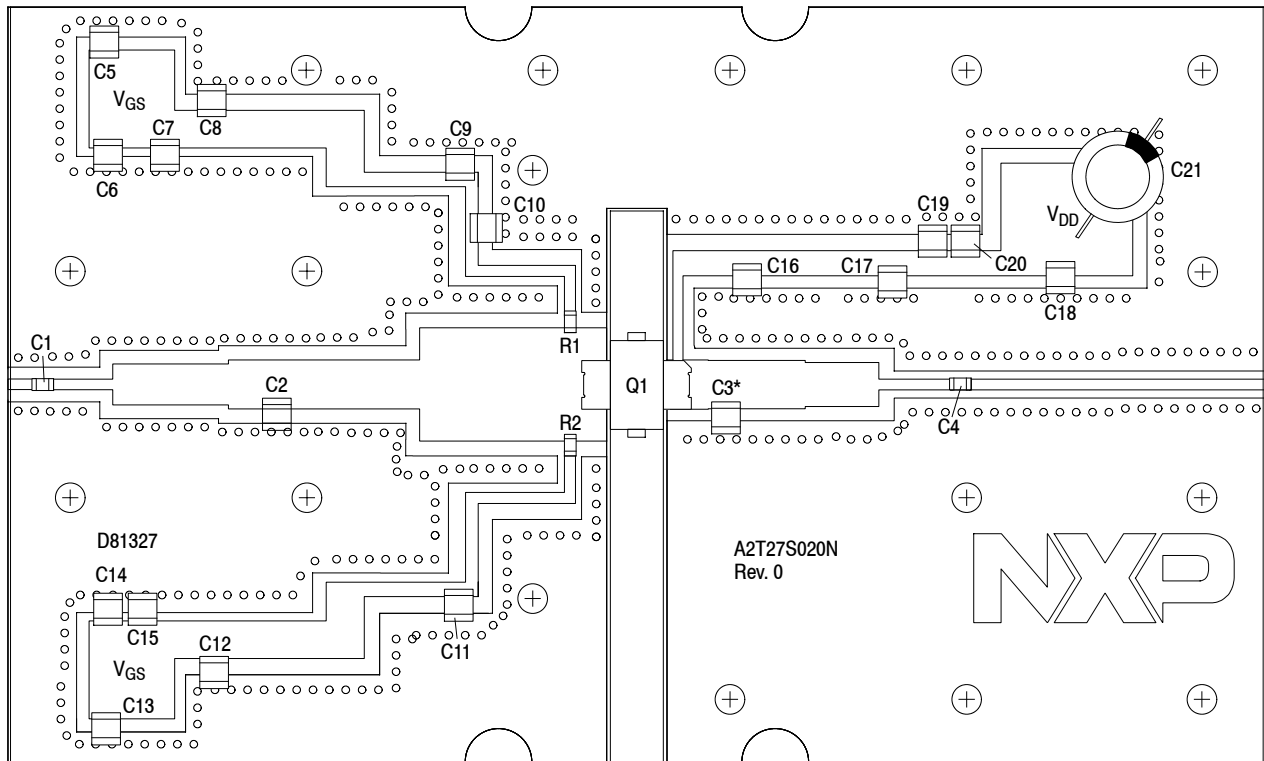

Figure 7. Broadband Frequency Response



*C3 is mounted vertically.

Note: All data measured in fixture with device soldered to heatsink.

Figure 8. A2T27S020NR1 Test Circuit Component Layout — 2110–2170 MHz

Table 8. A2T27S020NR1 Test Circuit Component Designations and Values — 2110–2170 MHz

Part	Description	Part Number	Manufacturer
C1	1.8 pF Chip Capacitor	ATC600F1R8BT250XT	ATC
C2	4.3 pF Chip Capacitor	ATC100B4R3CT500XT	ATC
C3	2.7 pF Chip Capacitor	ATC100B2R7BT500XT	ATC
C4	2.4 pF Chip Capacitor	ATC600F2R4BT250XT	ATC
C5, C13	22 μ F, 35 V Tantalum Capacitor	T491X226K035AT	Kemet
C6, C14, C18	2.2 μ F Chip Capacitor	C1825C225J5RACTU	Kemet
C7, C15, C20	0.1 μ F Chip Capacitor	CDR33BX104AKWS	AVX
C8, C12, C19	220 nF Chip Capacitor	C1812C224K5RACTU	Kemet
C9, C11, C17	2.2 μ F Chip Capacitor	C3225X7R1H225K250AB	TDK
C10, C16	6.8 pF Chip Capacitor	ATC100B6R8CT500XT	ATC
C21	470 μ F, 63 V Electrolytic Capacitor	MCGPR63V477M13X26-RH	Multicomp
Q1	RF Power LDMOS Transistor	A2T27S020N	NXP
R1, R2	2.2 Ω , 1/4 W Chip Resistor	CRCW12062R20JNEA	Vishay
PCB	Rogers RO4350B, 0.020", $\epsilon_r = 3.66$	D81327	Rogers

TYPICAL CHARACTERISTICS — 2110–2170 MHz

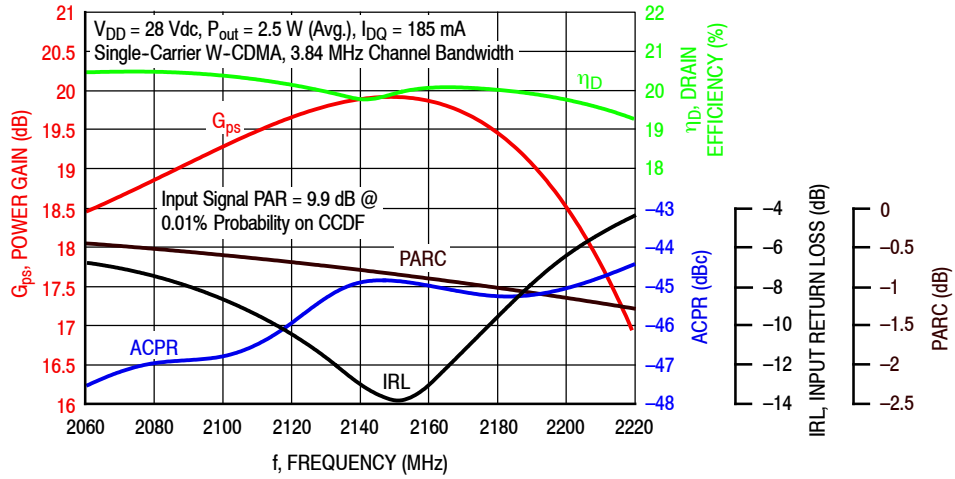

Figure 9. Single-Carrier Output Peak-to-Average Ratio Compression (PARC) Broadband Performance @ $P_{out} = 2.5$ Watts Avg.

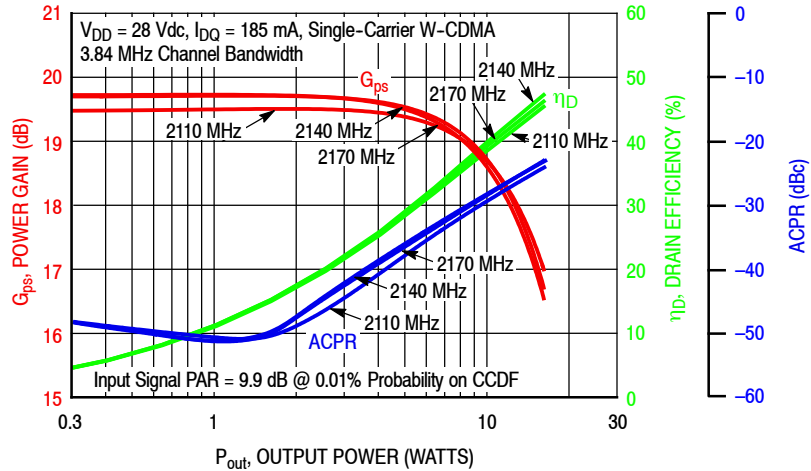

Figure 10. Single-Carrier W-CDMA Power Gain, Drain Efficiency and ACPR versus Output Power

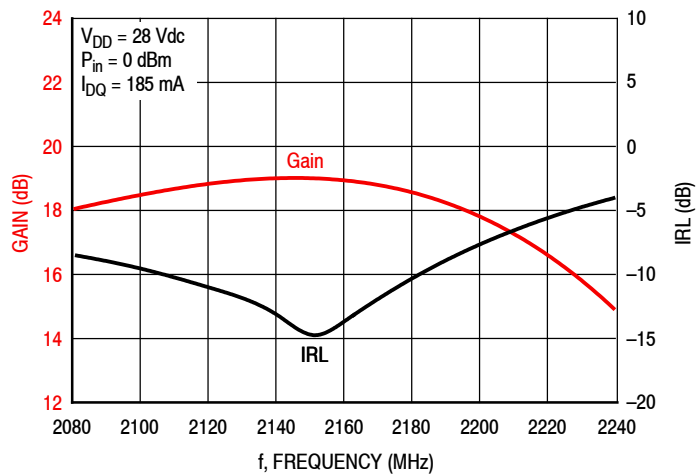
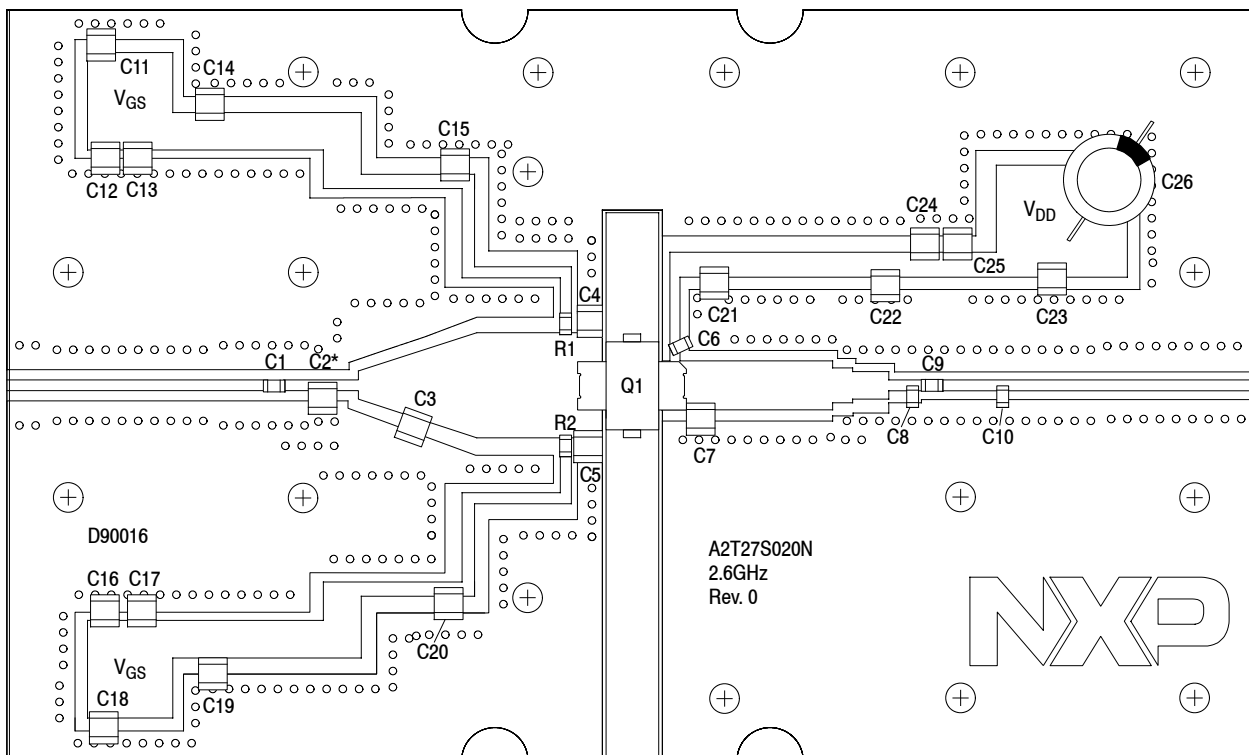

Figure 11. Broadband Frequency Response



*C2 is mounted vertically.

Note: All data measured in fixture with device soldered to heatsink.

Figure 12. A2T27S020NR1 Test Circuit Component Layout — 2575–2635 MHz

Table 9. A2T27S020NR1 Test Circuit Component Designations and Values — 2575–2635 MHz

Part	Description	Part Number	Manufacturer
C1	7.5 pF Chip Capacitor	ATC600F7R5BT250XT	ATC
C2	1 pF Chip Capacitor	ATC100B1R0BT500XT	ATC
C3	2.4 pF Chip Capacitor	ATC600S2R4BT250XT	ATC
C4, C5, C7	1.5 pF Chip Capacitor	ATC100B1R5BT500XT	ATC
C6	2.2 pF Chip Capacitor	ATC600F2R2BT250XT	ATC
C8	0.75 pF Chip Capacitor	GQM2195C2ER75BB12D	Murata
C9	6.8 pF Chip Capacitor	ATC600F6R8BT250XT	ATC
C10	1.2 pF Chip Capacitor	ATC600F1R2BT250XT	ATC
C11, C18	22 μ F, 35 V Tantalum Capacitor	T491X226K035AT	Kemet
C12, C16, C23	2.2 μ F Chip Capacitor	C1825C225J5RAC-TV	Kemet
C13, C17, C25	0.1 μ F Chip Capacitor	CDR33BX104AKWS	AVX
C14, C19, C24	220 nF Chip Capacitor	C1812C224K5RAC-TV	Kemet
C15, C20, C22	2.2 μ F Chip Capacitor	C3225X7R1H225K	TDK
C21	6.8 pF Chip Capacitor	ATC100B6R8CT500XT	ATC
C26	470 μ F, 63 V Electrolytic Capacitor	MCGPR63V477M13X26-RH	Multicomp
Q1	RF Power LDMOS Transistor	A2T27S020N	NXP
R1, R2	2.2 Ω , 1/4 W Chip Resistor	CRCW12062R20JNEA	Vishay
PCB	Rogers RO4350B, 0.020", $\epsilon_r = 3.66$	D90016	MTL

TYPICAL CHARACTERISTICS — 2575–2635 MHz

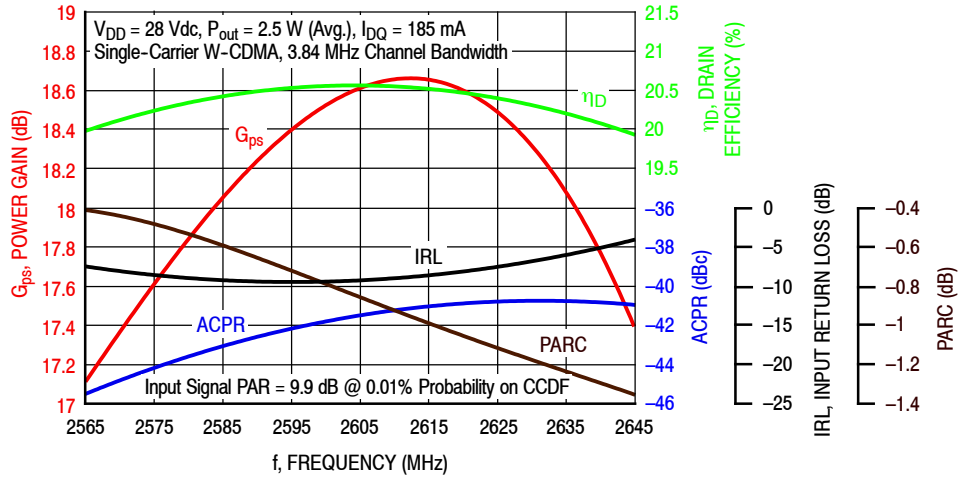

Figure 13. Single-Carrier Output Peak-to-Average Ratio Compression (PARC) Broadband Performance @ $P_{out} = 2.5$ Watts Avg.

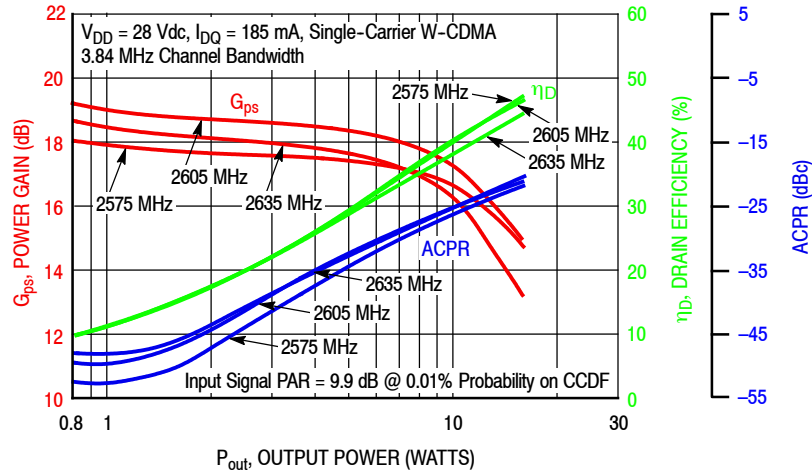

Figure 14. Single-Carrier W-CDMA Power Gain, Drain Efficiency and ACPR versus Output Power

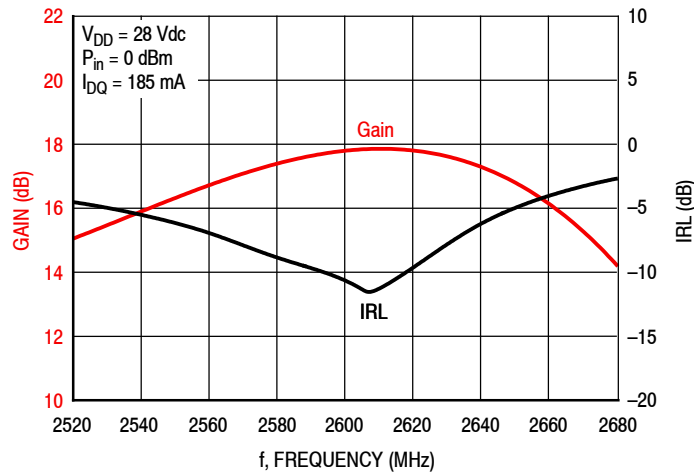
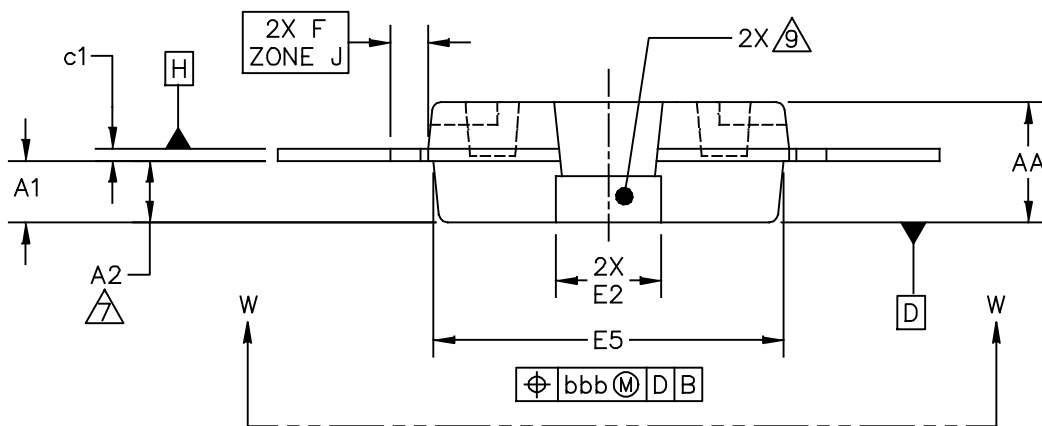
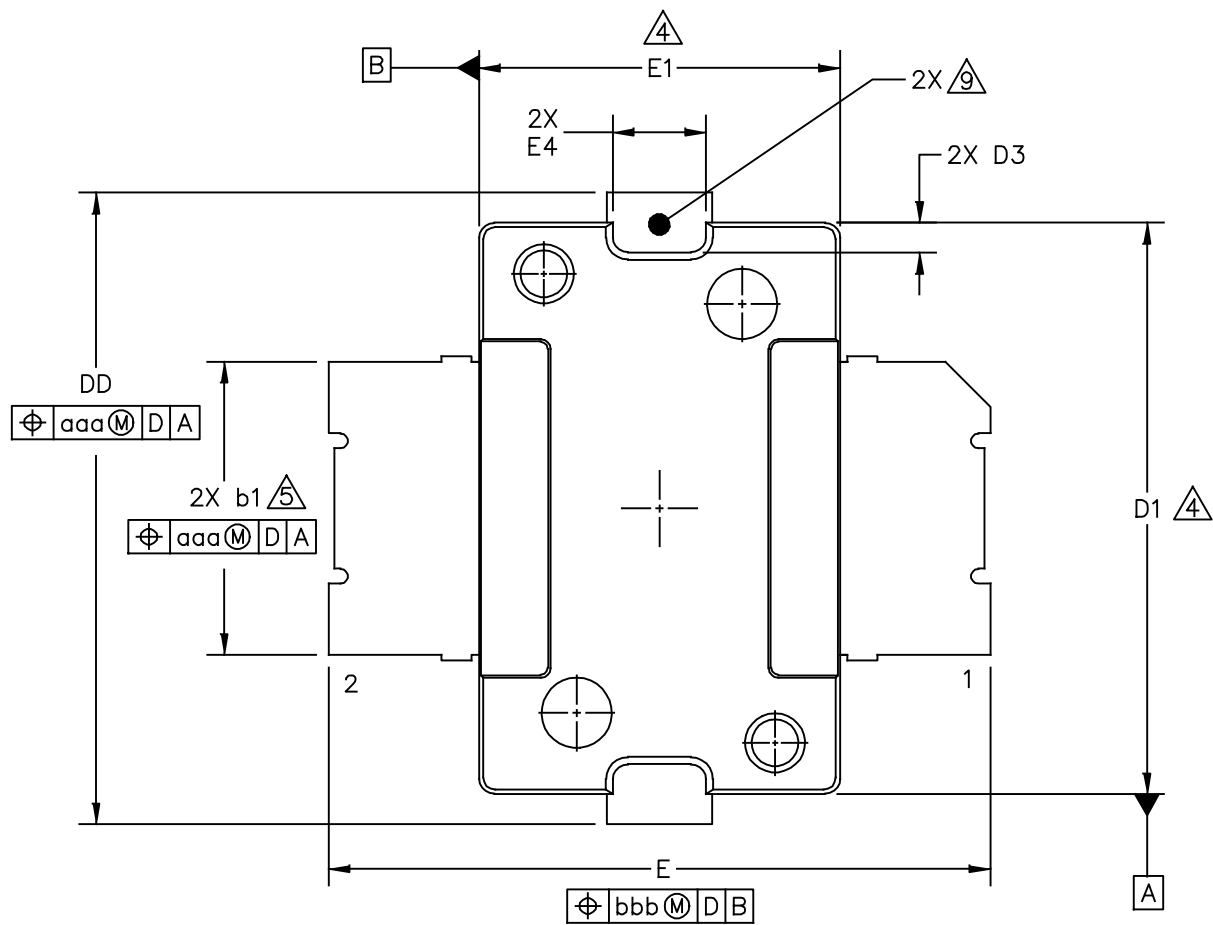

Figure 15. Broadband Frequency Response

PACKAGE DIMENSIONS



© NXP SEMICONDUCTORS N.V. ALL RIGHTS RESERVED	MECHANICAL OUTLINE	PRINT VERSION NOT TO SCALE
TITLE: TO-270-2	DOCUMENT NO: 98ASH98117A	REV: R
	STANDARD: NON-JEDEC	
	SOT1732-1	22 FEB 2016

A2T27S020NR1 A2T27S020GNR1

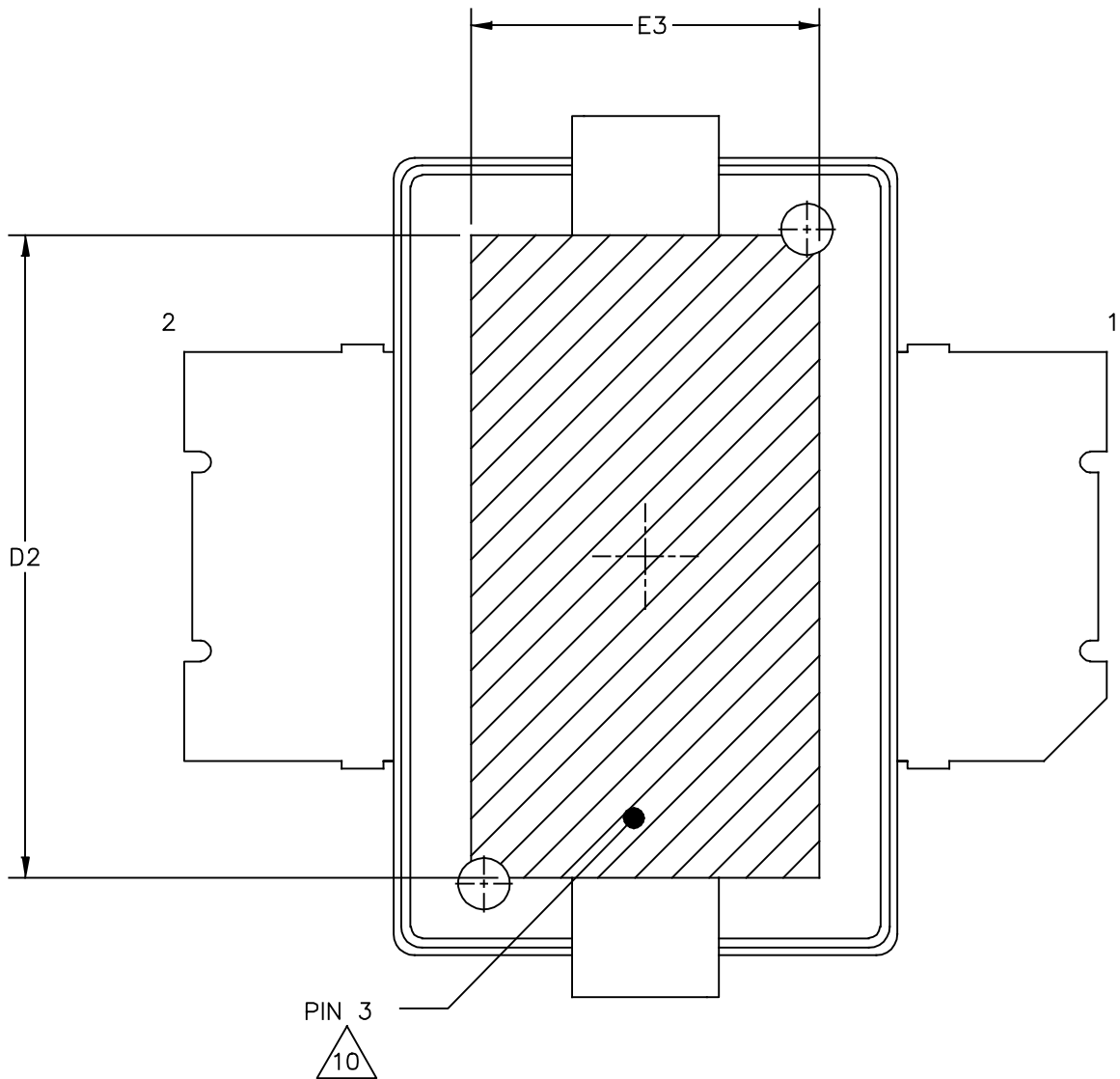

VIEW W-W
BOTTOM VIEW

© NXP SEMICONDUCTORS N.V. ALL RIGHTS RESERVED	MECHANICAL OUTLINE	PRINT VERSION NOT TO SCALE	
TITLE: TO-270-2	DOCUMENT NO: 98ASH98117A REV: R		
	STANDARD: NON-JEDEC		
	SOT1732-1	22 FEB 2016	

NOTES:

1. CONTROLLING DIMENSION: INCH
2. INTERPRET DIMENSIONS AND TOLERANCES PER ASME Y14.5M-1994.
3. DATUM PLANE H IS LOCATED AT TOP OF LEAD AND IS COINCIDENT WITH THE LEAD WHERE THE LEAD EXITS THE PLASTIC BODY AT THE TOP OF THE PARTING LINE.
4. DIMENSIONS D1 AND E1 DO NOT INCLUDE MOLD PROTRUSION. ALLOWABLE PROTRUSION IS .006 INCH (0.15 MM) PER SIDE. DIMENSIONS D1 AND E1 DO INCLUDE MOLD MISMATCH AND ARE DETERMINED AT DATUM PLANE H.
5. DIMENSION b1 DOES NOT INCLUDE DAMBAR PROTRUSION. ALLOWABLE DAMBAR PROTRUSION SHALL BE .005 INCH (0.13 MM) TOTAL IN EXCESS OF THE b1 DIMENSION AT MAXIMUM MATERIAL CONDITION.
6. DATUMS A AND B TO BE DETERMINED AT DATUM PLANE H.
7. DIMENSION A2 APPLIES WITHIN ZONE J ONLY.
8. DIMENSIONS DD AND E2 DO NOT INCLUDE MOLD PROTRUSION. OVERALL LENGTH INCLUDING MOLD PROTRUSION SHOULD NOT EXCEED 0.430 INCH (10.92 MM) FOR DIMENSION DD AND 0.080 INCH (2.03 MM) FOR DIMENSION E2. DIMENSIONS DD AND E2 DO INCLUDE MOLD MISMATCH AND ARE DETERMINED AT DATUM PLANE D.
9. THESE SURFACES OF THE HEAT SLUG ARE NOT PART OF THE SOLDERABLE SURFACES AND MAY REMAIN UNPLATED.
10. HATCHING REPRESENTS THE EXPOSED AREA OF THE HEAT SLUG. DIMENSIONS D2 AND E3 REPRESENT THE VALUES BETWEEN THE TWO OPPOSITE POINTS ALONG THE EDGES OF EXPOSED AREA OF THE HEAT SLUG.

DIM	INCH		MILLIMETER		DIM	INCH		MILLIMETER	
	MIN	MAX	MIN	MAX		MIN	MAX	MIN	MAX
AA	.078	.082	1.98	2.08	E4	.058	.066	1.47	1.68
A1	.039	.043	0.99	1.09	E5	.231	.235	5.87	5.97
A2	.040	.042	1.02	1.07	F	.025 BSC		0.64 BSC	
DD	.416	.424	10.57	10.77	b1	.193	.199	4.90	5.06
D1	.378	.382	9.60	9.70	c1	.007	.011	0.18	0.28
D2	.290	----	7.37	----	aaa	.004		0.10	
D3	.016	.024	0.41	0.61	bbb	.008		0.20	
E	.436	.444	11.07	11.28					
E1	.238	.242	6.04	6.15					
E2	.066	.074	1.68	1.88					
E3	.150	----	3.81	----					

© NXP SEMICONDUCTORS N.V. ALL RIGHTS RESERVED		MECHANICAL OUTLINE	PRINT VERSION NOT TO SCALE
TITLE: TO-270-2		DOCUMENT NO: 98ASH98117A REV: R	
		STANDARD: NON-JEDEC	
		SOT1732-1	22 FEB 2016

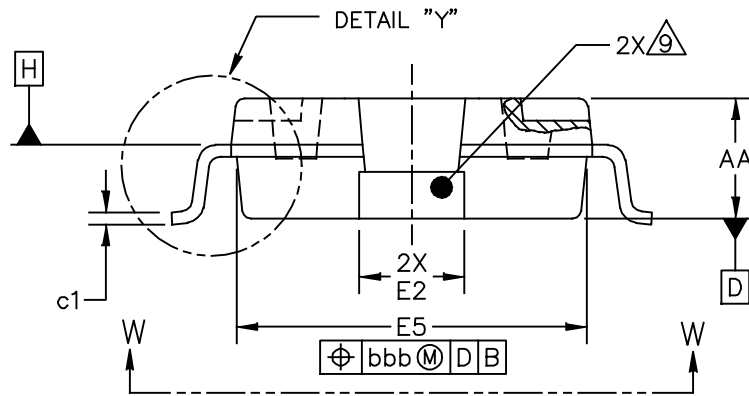
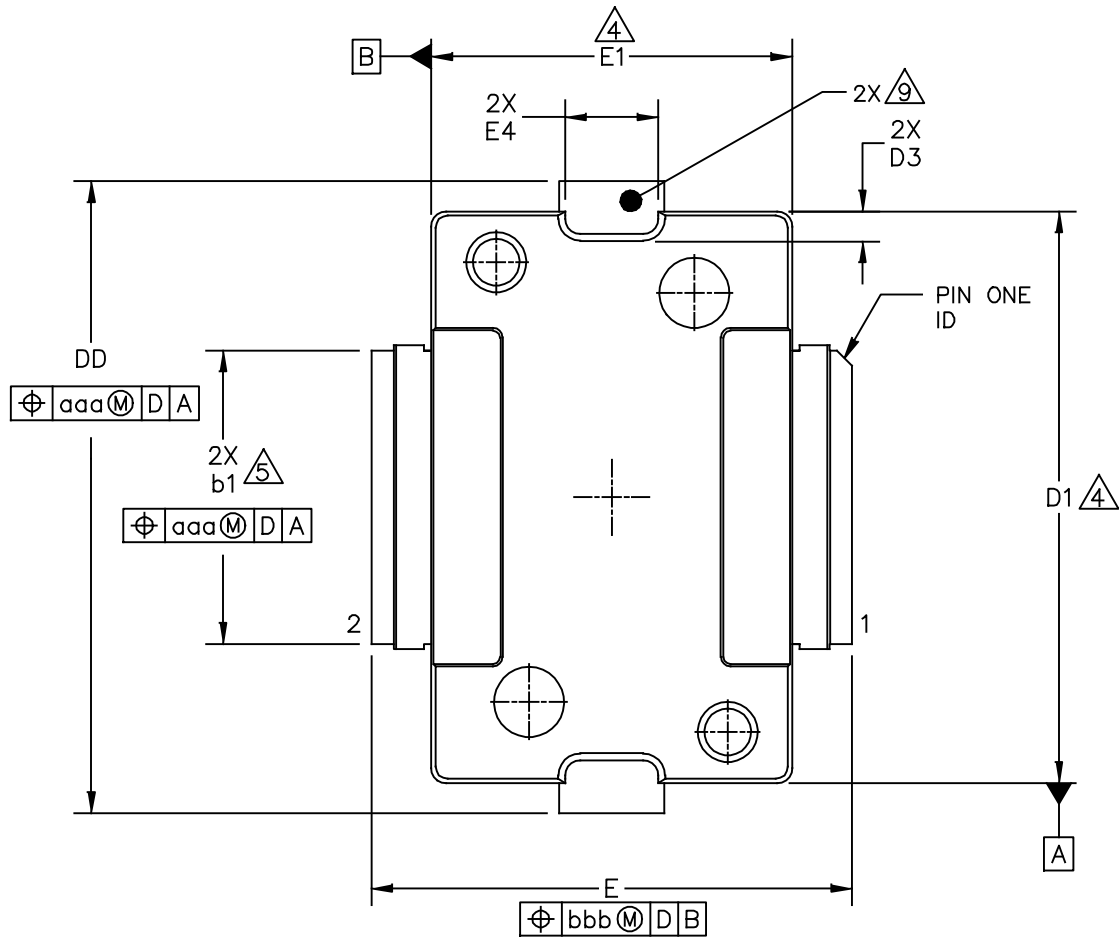

© NXP SEMICONDUCTORS N.V. ALL RIGHTS RESERVED	MECHANICAL OUTLINE	PRINT VERSION NOT TO SCALE
TITLE: TO-270G-2	DOCUMENT NO: 98ASA99301D STANDARD: JEDEC TO-270 BA SOT1731-1	REV: D 28 MAR 2016

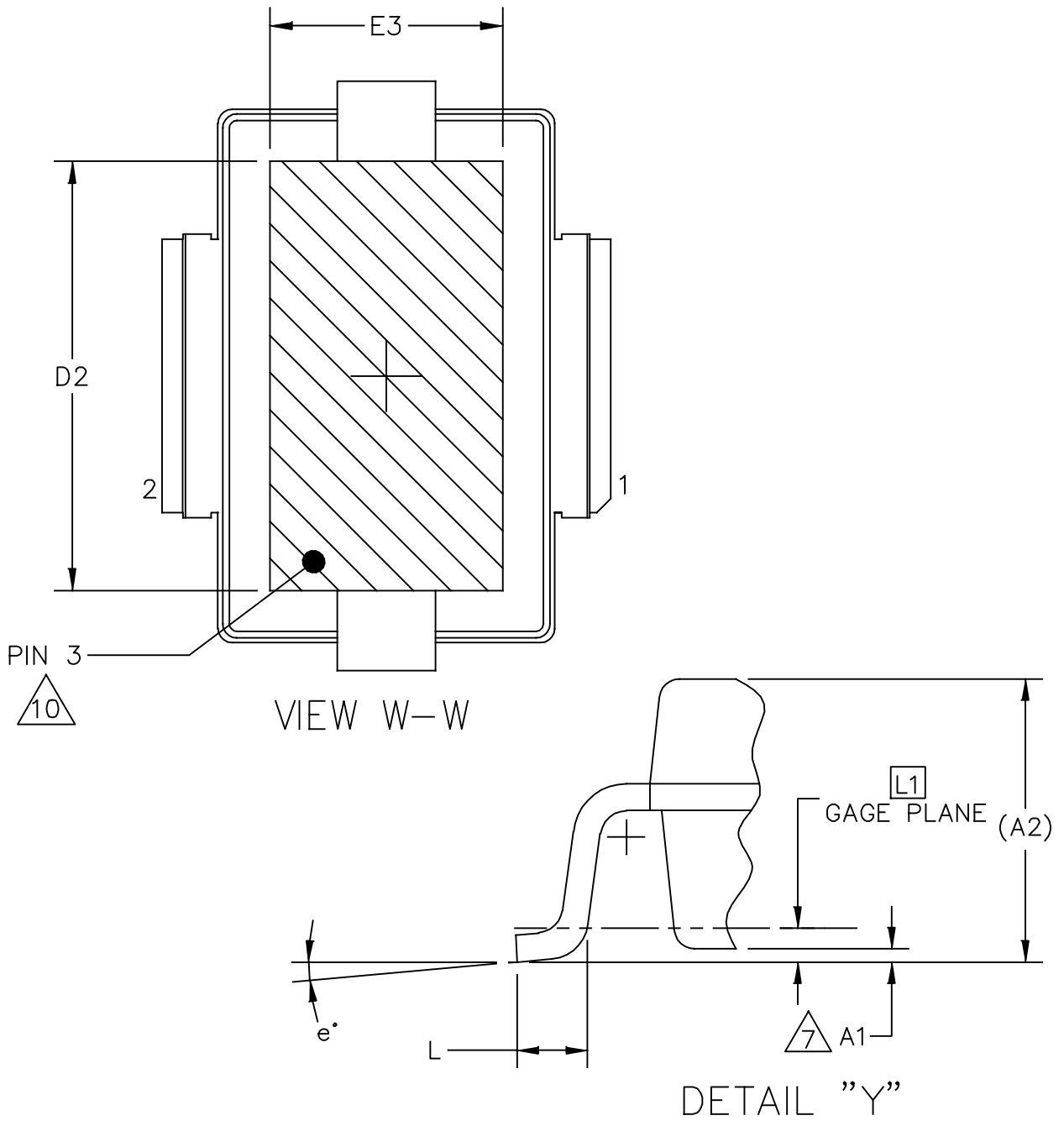

© NXP SEMICONDUCTORS N.V. ALL RIGHTS RESERVED	MECHANICAL OUTLINE	PRINT VERSION NOT TO SCALE
TITLE: TO-270G-2	DOCUMENT NO: 98ASA99301D	REV: D
	STANDARD: JEDEC TO-270 BA	
	SOT1731-1	28 MAR 2016

NOTES:

1. CONTROLLING DIMENSION: INCH

2. INTERPRET DIMENSIONS AND TOLERANCES PER ASME Y14.5M-1994.

3. DATUM PLANE H IS LOCATED AT TOP OF LEAD AND IS COINCIDENT WITH THE LEAD WHERE THE LEAD EXITS THE PLASTIC BODY AT THE TOP OF THE PARTING LINE.

4. DIMENSIONS "D1" AND "E1" DO NOT INCLUDE MOLD PROTRUSION. ALLOWABLE PROTRUSION IS .006 INCH (0.15MM) PER SIDE. DIMENSIONS "D1 AND "E1" DO INCLUDE MOLD MISMATCH AND ARE DETERMINED AT DATUM PLANE H.

5. DIMENSION b1 DOES NOT INCLUDE DAMBAR PROTRUSION. ALLOWABLE DAMBAR PROTRUSION SHALL BE .005 INCH (0.13 MM) TOTAL IN EXCESS OF THE b1 DIMENSION AT MAXIMUM MATERIAL CONDITION.

6. DATUMS A AND B TO BE DETERMINED AT DATUM PLANE H.

7. DIMENSION A1 IS MEASURED WITH REFERENCE TO DATUM D. THE POSITIVE VALUE IMPLIES THAT THE BOTTOM OF THE PACKAGE IS HIGHER THAN THE BOTTOM OF THE LEAD.

8. DIMENSIONS DD AND E2 DO NOT INCLUDE MOLD PROTRUSION. OVERALL LENGTH INCLUDING MOLD PROTRUSION SHOULD NOT EXCEED 0.430 INCH (10.92 MM) FOR DIMENSION DD AND 0.080 INCH (2.03 MM) FOR DIMENSION E2.

9. THESE SURFACES OF THE HEAT SLUG ARE NOT PART OF THE SOLDERABLE SURFACES AND MAY REMAIN UNPLATED.

10. HATCHING REPRESENTS THE EXPOSED AND SOLDERABLE AREA OF THE HEAT SLUG. DIMENSIONS D2 AND E3 REPRESENT THE VALUES BETWEEN THE TWO OPPOSITE POINTS ALONG THE EDGES OF EXPOSED AREA OF THE HEAT SLUG.

DIM	INCH		MILLIMETER		DIM	INCH		MILLIMETER	
	MIN	MAX	MIN	MAX		MIN	MAX	MIN	MAX
AA	.078	.082	1.98	2.08	L	.018	.024	0.46	0.61
A1	.001	.004	0.03	0.10	L1	.010 BSC		0.25 BSC	
A2	(.083)		(2.11)		b1	.193	.199	4.90	5.06
DD	.416	.424	10.57	10.77	c1	.007	.011	0.18	0.28
D1	.378	.382	9.60	9.70	e	2'	8'	2'	8'
D2	.290	-	7.37	-	aaa	.004		0.10	
D3	.016	.024	0.41	0.61	bbb	.008		0.20	
E	.316	.324	8.03	8.23					
E1	.238	.242	6.04	6.15					
E2	.066	.074	1.68	1.88					
E3	.150	-	3.81	-					
E4	.058	.066	1.47	1.68					
E5	.231	.235	5.87	5.97					

© NXP SEMICONDUCTORS N.V.
ALL RIGHTS RESERVED

MECHANICAL OUTLINE

PRINT VERSION NOT TO SCALE

TITLE:

TO-270G-2

DOCUMENT NO: 98ASA99301D

REV: D

STANDARD: JEDEC TO-270 BA

SOT1731-1

28 MAR 2016

PRODUCT DOCUMENTATION, SOFTWARE AND TOOLS

Refer to the following resources to aid your design process.

Application Notes

- AN1907: Solder Reflow Attach Method for High Power RF Devices in Over-Molded Plastic Packages
- AN1955: Thermal Measurement Methodology of RF Power Amplifiers
- AN3789: Clamping of High Power RF Transistors and RFICs in Over-Molded Plastic Packages

Engineering Bulletins

- EB212: Using Data Sheet Impedances for RF LDMOS Devices

Software

- Electromigration MTTF Calculator
- .s2p File

Development Tools

- Printed Circuit Boards

To Download Resources Specific to a Given Part Number:

1. Go to <http://www.nxp.com/RF>
2. Search by part number
3. Click part number link
4. Choose the desired resource from the drop down menu

REVISION HISTORY

The following table summarizes revisions to this document.

Revision	Date	Description
0	Mar. 2017	<ul style="list-style-type: none">• Initial release of data sheet
1	Jan. 2018	<ul style="list-style-type: none">• Frequency band performance tables, 2100 and 2600 MHz: data values updated to reflect true capability of the device, p. 1• 1805–1880 MHz, 2110–2170 MHz and 2575–2635 MHz performance data tables and circuit component layouts: updated to show all data measured in fixture with device soldered to heatsink, pp. 1, 3, 4, 7, 9• 2110–2170 MHz Typical Characteristic performance graphs: performance graphs added to data sheet, p. 8• 2575–2635 MHz Typical Characteristic performance graphs: performance graphs added to data sheet, p. 10
2	Mar. 2019	<ul style="list-style-type: none">• Fig. 1, Pin Connections, corrected Drain (Pin 1) and Gate (Pin 2) to reflect correct pin numbers, p. 1

How to Reach Us:

Home Page:
nxp.com

Web Support:
nxp.com/support

Information in this document is provided solely to enable system and software implementers to use NXP products. There are no express or implied copyright licenses granted hereunder to design or fabricate any integrated circuits based on the information in this document. NXP reserves the right to make changes without further notice to any products herein.

NXP makes no warranty, representation, or guarantee regarding the suitability of its products for any particular purpose, nor does NXP assume any liability arising out of the application or use of any product or circuit, and specifically disclaims any and all liability, including without limitation consequential or incidental damages. "Typical" parameters that may be provided in NXP data sheets and/or specifications can and do vary in different applications, and actual performance may vary over time. All operating parameters, including "typicals," must be validated for each customer application by customer's technical experts. NXP does not convey any license under its patent rights nor the rights of others. NXP sells products pursuant to standard terms and conditions of sale, which can be found at the following address: nxp.com/SalesTermsandConditions.

NXP, the NXP logo and Airfast are trademarks of NXP B.V. All other product or service names are the property of their respective owners.

© 2017–2019 NXP B.V.

Looking for pricing, stock, or lifecycle information?

Click below to explore more details on WIN SOURCE:

 [View A2T27S020GNR1 on WIN SOURCE](#)

 [NXP / Nexperia Information](#)

Optimize Your Supply Chain with WIN SOURCE Solutions

-  Global Sourcing Solution
-  Obsolete Management
-  Cost Control Management
-  Shortage Management
-  Alternative Solution
-  Excess Inventory Management