



**THE DATASHEET OF
BLM9D2327-25BZ**



BLM9D2327-25B

LDMOS 2-stage integrated Doherty MMIC

Rev. 1 — 1 September 2017

AMPLEON

Product data sheet

1. Product profile

1.1 General description

The BLM9D2327-25B is a 2-stage fully integrated Doherty MMIC solution using Ampleon's state of the art GEN9 LDMOS technology. The carrier and peaking device, input splitter and output combiner are integrated in a single package. This multiband device is perfectly suited as general purpose driver or small cell final in the frequency range from 2300 MHz to 2700 MHz. Available in PQFN outline.

Table 1. Application performance

Typical RF performance tuned in a wideband 2300 MHz to 2700 MHz application board at $T_{case} = 25\text{ }^{\circ}\text{C}$; $I_{Dq} = 76\text{ mA}$ (carrier); $V_{GSq(peaking)} = V_{GSq(carrier)} - 0.81\text{ V}$. Test signal: 1-carrier LTE 20 MHz; PAR = 7.2 dB at 0.01% probability on CCDF.

Test signal	f	V _{DS}	P _{L(AV)}	G _p	η _D
	(MHz)	(V)	(W)	(dB)	(%)
single carrier LTE 20 MHz	2500	28	4.9	28.5	40.3

1.2 Features and benefits

- Integrated input splitter
- Integrated output combiner
- High efficiency
- Designed for broadband operation (frequency 2300 MHz to 2700 MHz)
- Independent control of carrier and peaking bias
- Integrated ESD protection
- Source impedance 50 Ω; high power gain
- Compliant to Directive 2002/95/EC, regarding restriction of hazardous substances (RoHS)

1.3 Applications

- RF power MMIC for multi-carrier and multi-standard GSM, W-CDMA and LTE base stations in the 2300 MHz to 2700 MHz frequency range.

2. Pinning information

2.1 Pinning

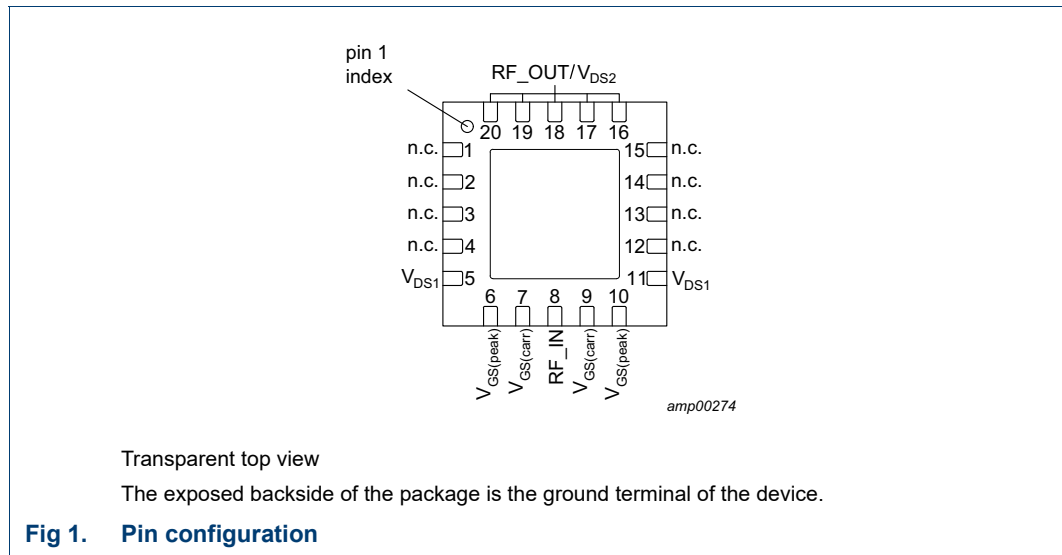

2.2 Pin description

Table 2. Pin description

Symbol	Pin	Description
n.c.	1	not connected
n.c.	2	not connected
n.c.	3	not connected
n.c.	4	not connected
V_{DS1}	5	drain-source voltage of driver stages
$V_{GS(peak)}$	6	gate-source voltage of peaking
$V_{GS(carr)}$	7	gate-source voltage of carrier
RF_IN	8	RF input
$V_{GS(carr)}$	9	gate-source voltage of carrier
$V_{GS(peak)}$	10	gate-source voltage of peaking
V_{DS1}	11	drain-source voltage of driver stages
n.c.	12	not connected
n.c.	13	not connected
n.c.	14	not connected
n.c.	15	not connected
RF_OUT/ V_{DS2}	16	RF output / drain-source voltage of final stages
RF_OUT/ V_{DS2}	17	RF output / drain-source voltage of final stages
RF_OUT/ V_{DS2}	18	RF output / drain-source voltage of final stages

Table 2. Pin description ...continued

Symbol	Pin	Description
RF_OUT/ V_{DS2}	19	RF output / drain-source voltage of final stages
RF_OUT/ V_{DS2}	20	RF output / drain-source voltage of final stages
GND	flange	RF ground

3. Ordering information

Table 3. Ordering information

Type number	Package		
	Name	Description	Version
BLM9D2327-25B	PQFN20	plastic thermal enhanced quad flat package; no leads; 20 terminals; body 8.0 x 8.0 x 2.1 mm	SOT1462-1

4. Block diagram

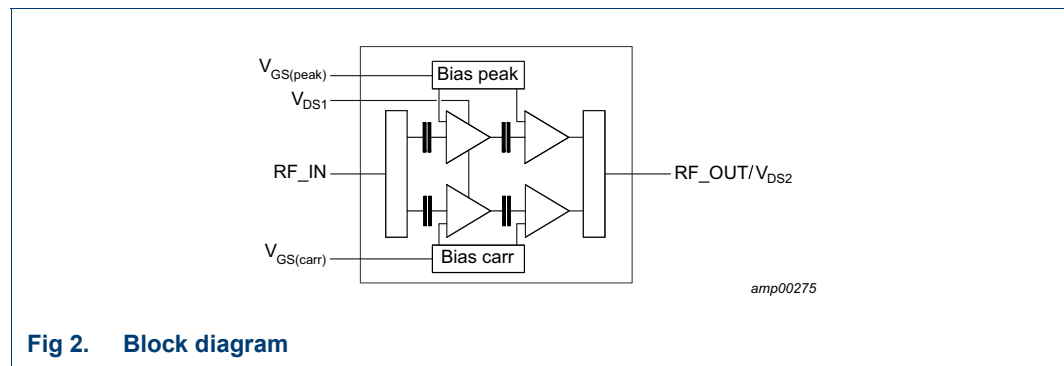

5. Limiting values

Table 4. Limiting values

In accordance with the Absolute Maximum Rating System (IEC 60134).

Symbol	Parameter	Conditions	Min	Max	Unit
V_{DS}	drain-source voltage		-	65	V
V_{GS}	gate-source voltage		-0.5	+13	V
T_{stg}	storage temperature		-65	+150	°C
T_j	junction temperature	[1]	-	175	°C

[1] Continuous use at maximum temperature will affect the reliability. For details refer to the online MTF calculator.

6. Thermal characteristics

Table 5. Thermal characteristics

Symbol	Parameter	Conditions	Value	Unit	
$R_{th(j-c)}$	thermal resistance from junction to case	$T_{case} = 90\text{ °C}; P_L = 4\text{ W}$	[1]	11	K/W
		$T_{case} = 90\text{ °C}; P_L = 2.5\text{ W}$	[1]	12	K/W

[1] When operated with a 1-carrier W-CDMA with PAR = 9.9 dB.

7. Characteristics

Table 6. DC characteristics

$T_{case} = 25\text{ °C}$.

Symbol	Parameter	Conditions	Min	Typ	Max	Unit
Carrier						
V_{GSq}	gate-source quiescent voltage	$V_{DS} = 28\text{ V}; I_D = 75\text{ mA}$	1.7	2.1	2.7	V
I_{GSS}	gate leakage current	$V_{GS} = 1\text{ V}; V_{DS} = 0\text{ V}$	-	-	140	nA
Peaking						
I_{GSS}	gate leakage current	$V_{GS} = 1\text{ V}; V_{DS} = 0\text{ V}$	-	-	140	nA
Final stages						
I_{DSS}	drain leakage current	$V_{GS} = 0\text{ V}; V_{DS} = 28\text{ V}$	-	-	1.4	μA
Driver stages						
I_{DSS}	drain leakage current	$V_{GS} = 0\text{ V}; V_{DS} = 28\text{ V}$	-	-	1.4	μA

Table 7. RF Characteristics

Typical RF performance at $T_{case} = 25\text{ °C}; V_{DS} = 28\text{ V}; I_{Dq} = 75\text{ mA}$ (carrier);

$V_{GSq(peaking)} = V_{GSq(carrier)} - 0.7\text{ V}; P_{L(AV)} = 5\text{ W}$.

Symbol	Parameter	Conditions	Min	Typ	Max	Unit
Test signal: pulsed CW						
G_p	power gain	$f = 2700\text{ MHz}$	25.5	27	28.5	dB
η_D	drain efficiency	$P_L = 5\text{ W}$ (37 dBm)	34	38	-	%
		$P_L = P_{L(3dB)}$	50	54.5	-	%
RL_{in}	input return loss		-	-20	-10	dB
$P_{L(3dB)}$	output power at 3 dB gain compression		44	44.6	-	dBm

8. Application information

Table 8. Typical performance

$T_{case} = 25\text{ °C}$; $V_{DS} = 28\text{ V}$; $I_{DQ} = 76\text{ mA}$ (carrier and peaking). Test signal: 1-carrier LTE; PAR = 7.2 dB at 0.01 % probability CCDF; unless otherwise specified, typical performance in an Ampleon $f = 2300\text{ MHz}$ to 2700 MHz frequency band symmetrical Doherty application circuit.

Symbol	Parameter	Conditions	Min	Typ	Max	Unit
$P_{L(3dB)}$	output power at 3 dB gain compression	$f = 2500\text{ MHz}$ [1]	-	44.9	-	dBm
$\varphi_{s21}/\varphi_{s21(norm)}$	normalized phase response	at 3 dB compression point; $f = 2500\text{ MHz}$ [2]	-	-5.9	-	°
η_D	drain efficiency	8 dB OBO ($P_{L(AV)} = 36.9\text{ dBm}$); $f = 2500\text{ MHz}$	-	40.3	-	%
G_p	power gain	$P_{L(AV)} = 36.9\text{ dBm}$; $f = 2500\text{ MHz}$	-	28.5	-	dB
B_{video}	video bandwidth	$P_{L(AV)} = 36\text{ dBm}$ set to obtain IMD3 = -30 dBc; 2-tone CW; $f = 2500\text{ MHz}$	-	420	-	MHz
G_{flat}	gain flatness	$P_{L(AV)} = 36.9\text{ dBm}$; $f = 2300\text{ MHz}$ to 2700 MHz	-	0.6	-	dB
$ACPR_{20M}$	adjacent channel power ratio (20M)	$P_{L(AV)} = 36.9\text{ dBm}$; $f = 2500\text{ MHz}$	-	-34.9	-	dBc
$\Delta G/\Delta T$	gain variation with temperature	$f = 2500\text{ MHz}$ [3]	-	0.04	-	dB/°C
K	Rollett stability factor	$T_{case} = -40\text{ °C}$; $f = 0.2\text{ GHz}$ to 4.5 GHz [3]	-	>2.2	-	

- [1] Pulsed CW power sweep measurement ($\delta = 10\%$, $t_p = 100\text{ }\mu\text{s}$).
- [2] 25 ms CW power sweep measurement.
- [3] Small signal CW measurements.

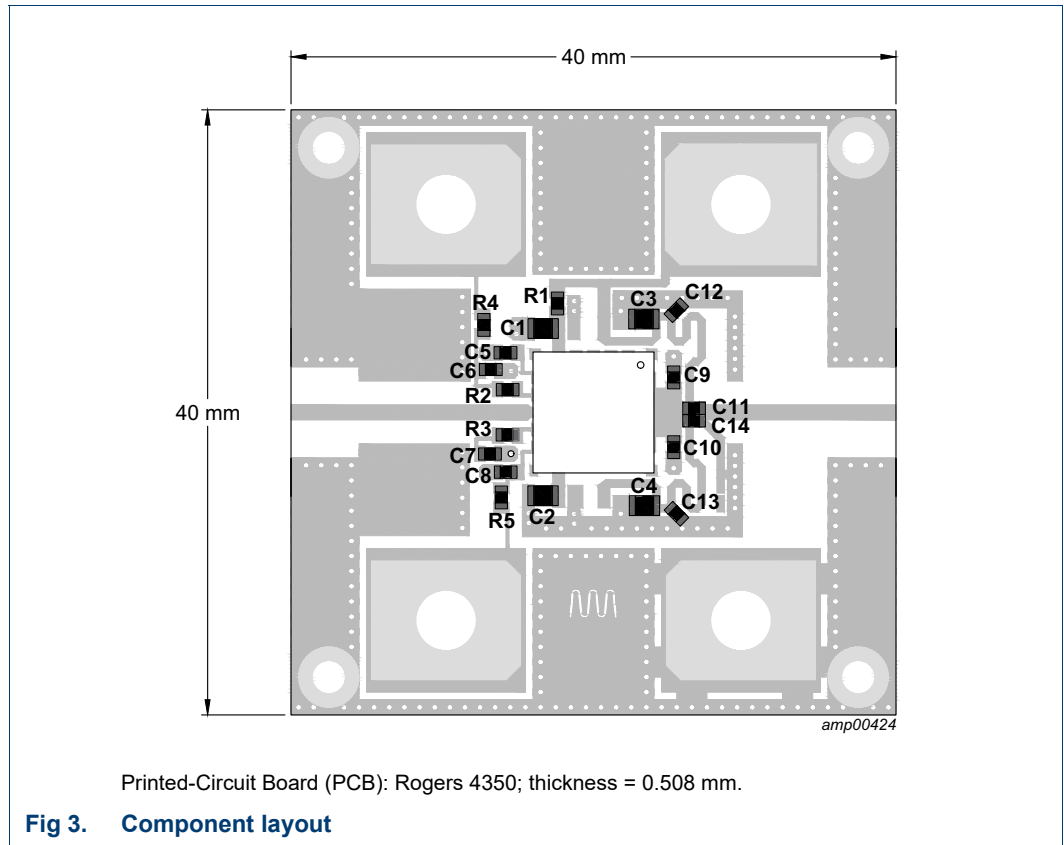
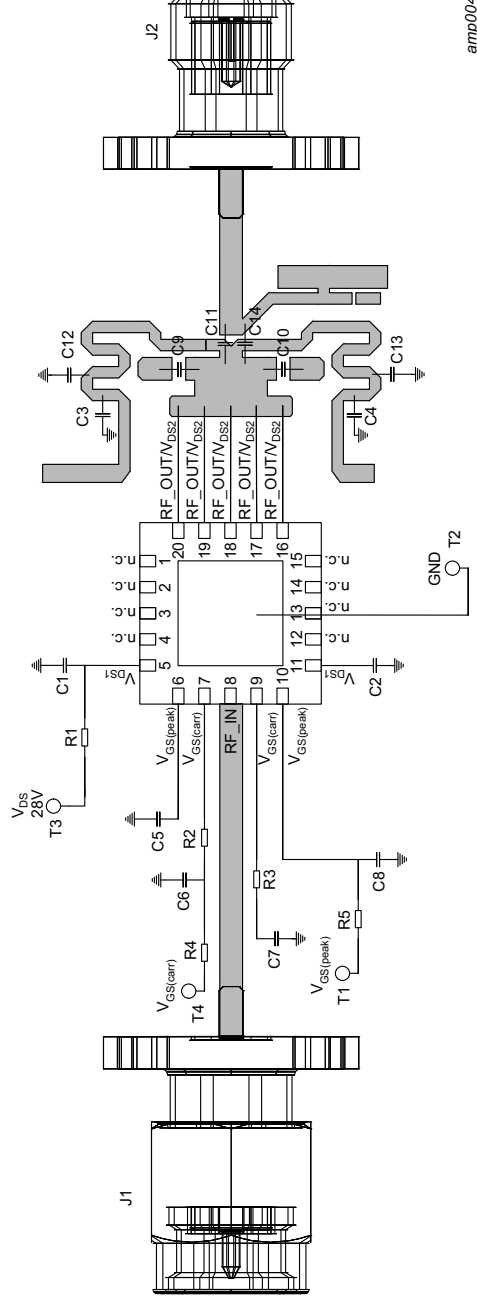

Table 9. Demo test circuit list of components

See [Figure 3](#) for component layout.

Component	Description	Value	Remarks
C1, C2, C3, C4	multilayer ceramic chip capacitor	10 μ F, 35 V	TDK: C2012X5R1V106M085ACL
C5, C6, C7, C8	multilayer ceramic chip capacitor	1 μ F, 25 V	AVX: 06033D105KAT2A
C9, C10	multilayer ceramic chip capacitor	1.8 pF	Murata: GQM1875C2E1R6BB12
C11	multilayer ceramic chip capacitor	1.6 pF	Murata: GQM1875C2E5R6BB12
C12, C13	multilayer ceramic chip capacitor	9.1 pF	Murata: GQM1875C2E5R6BB12
C14	multilayer ceramic chip capacitor	0.5 pF	Murata: GQM1875C2E5R6BB12
J1	SMA Coaxial panel connector male		Hubner & Suhner: 13_SMA-50-0-2/111_N
J2	SMA Coaxial panel connector female		Hubner & Suhner: 23_SMA-50-0-2/111_N
R1	SMD resistor	0 Ω , ± 1 %	Multicomp: MC805
R2, R3	SMD resistor	5.1 Ω , ± 1 %	Multicomp: MC805
R4	SMD resistor	820 Ω , ± 1 %	Multicomp: MC805
R5	SMD resistor	10 Ω , ± 1 %	Multicomp: MC805
T1, T2, T3, T4	PCB Terminal	6.35 mm \times 0.81 mm, 4.1 mm	TE connectivity



amp00-

Fig 4. Electrical schematic

8.1 Ruggedness in a Doherty operation

The BLM9D2327-25B is capable of withstanding a load mismatch corresponding to VSWR = 10 : 1 through all phases under the following conditions: $V_{DS} = 32\text{ V}$; $I_{Dq} = 75\text{ mA}$ (carrier); $V_{GSq(peak)} = V_{GSq(carrier)} - 0.7\text{ V}$; P_1 corresponding to $P_{L(3dB)}$ under $Z_S = 50\ \Omega$ load; $f = 2700\text{ MHz}$ (1-carrier W-CDMA; PAR = 9.9 dB); $T_{case} = 25\text{ }^\circ\text{C}$.

8.2 Impedance information

Table 10. Typical impedance for optimum Doherty operation

Measured load-pull data per section; test signal: pulsed CW; $T_{case} = 25\text{ }^\circ\text{C}$; $V_{DS} = 28\text{ V}$; $I_{Dq} = 70\text{ mA}$ (carrier); $V_{GSq(peak)} = V_{GSq(carrier)} - 0.7\text{ V}$; $t_p = 100\ \mu\text{s}$; $\delta = 10\%$.

f (MHz)	tuned for optimum Doherty operation				
	Z_L (Ω)	$P_{L(3dB)}$ (dBm)	$G_{p(max)}$ (dB)	η_{add} [1] (%)	η_{add} [2] (%)
2300	5.30 – j2.38	45.30	28.60	53.10	42.80
2400	5.62 – j3.81	45.30	29.00	55.00	44.10
2500	6.34 – j4.52	45.20	29.40	57.00	45.00
2600	7.67 – j4.10	45.00	29.40	59.10	43.50
2700	7.25 – j2.89	44.90	28.70	58.90	40.70

[1] at 44.5 dBm.

[2] at 36.5 dBm.

8.3 Graphs

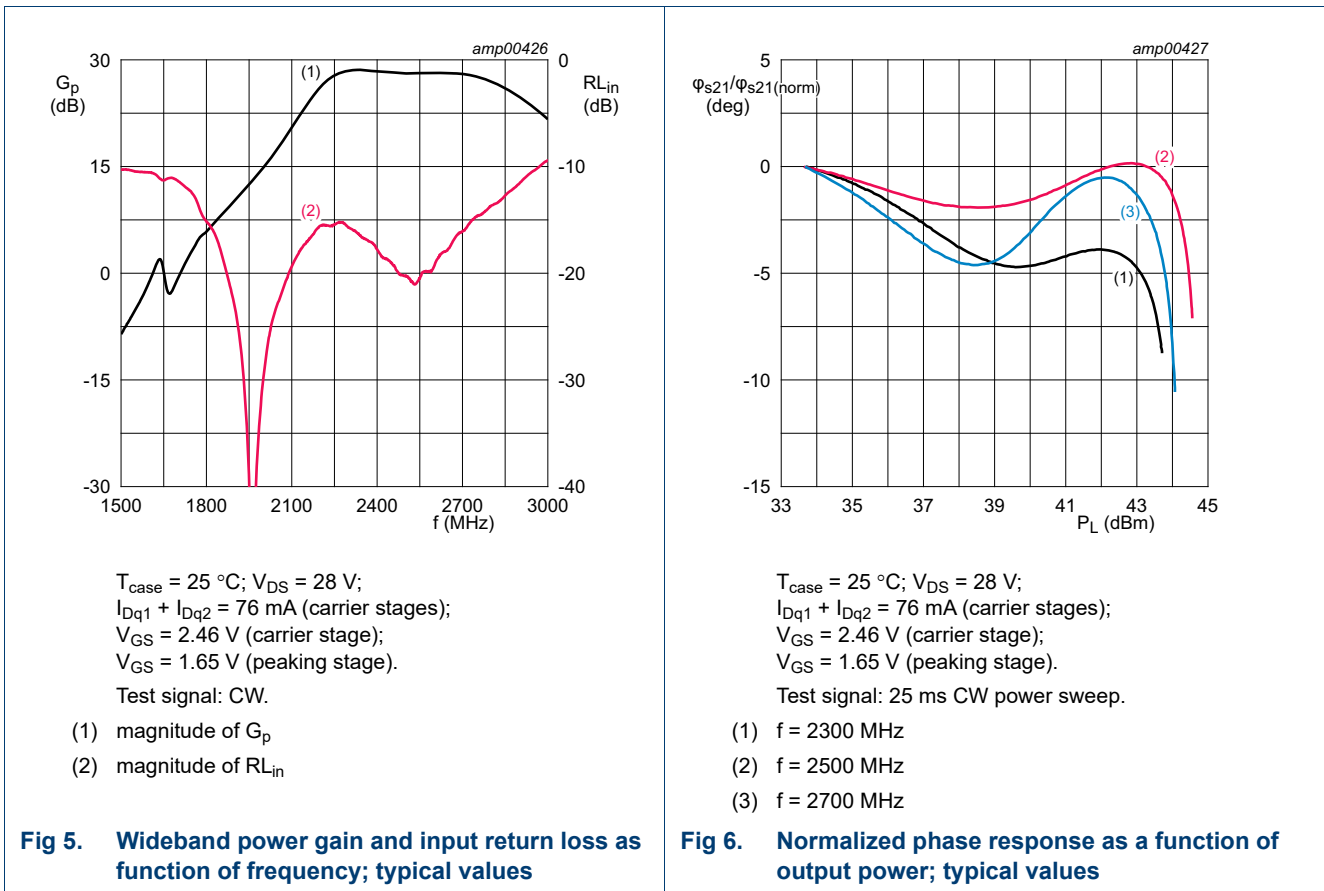

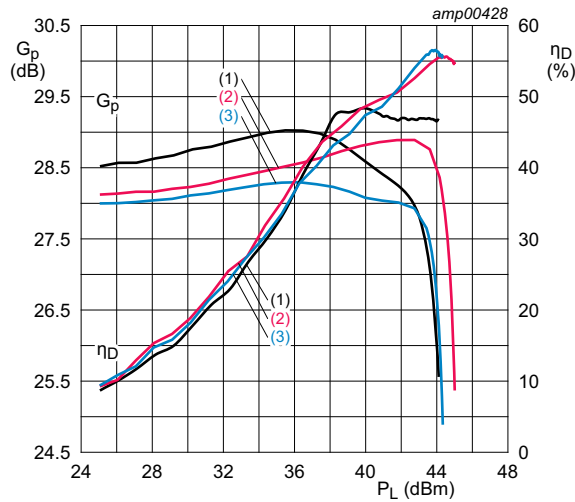

$T_{case} = 25\text{ }^{\circ}\text{C}$; $V_{DS} = 28\text{ V}$; $I_{Dq1} + I_{Dq2} = 76\text{ mA}$ (carrier stages);
 $V_{GS} = 2.46\text{ V}$ (carrier stage);
 $V_{GS} = 1.65\text{ V}$ (peaking stage).

Test signal: pulsed CW power sweep ($\delta = 10\%$; $t_p = \mu\text{s}$).

- (1) $f = 2300\text{ MHz}$
- (2) $f = 2500\text{ MHz}$
- (3) $f = 2700\text{ MHz}$

Fig 7. Power gain and drain efficiency as function of output power; typical values

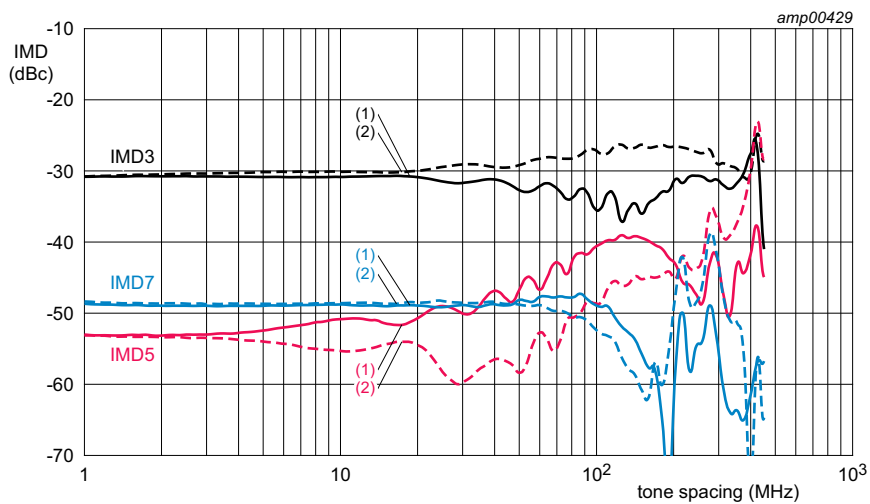

$T_{case} = 25\text{ }^{\circ}\text{C}$; $V_{DS} = 28\text{ V}$; $I_{Dq1} + I_{Dq2} = 76\text{ mA}$ (carrier stages);
 $V_{GS} = 2.46\text{ V}$ (carrier stage); $V_{GS} = 1.65\text{ V}$ (peaking stage); $P_{L(AV)} = 4\text{ W}$.

Test signal: 2-tone CW; $f_c = 2500\text{ MHz}$.

- (1) IMD low
- (2) IMD high

Fig 8. Intermodulation distortion as a function of tone spacing; typical values

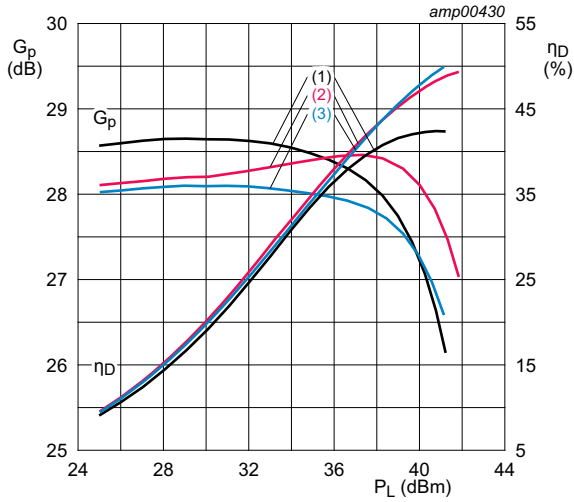

$T_{case} = 25\text{ }^{\circ}\text{C}$; $V_{DS} = 28\text{ V}$;
 $I_{Dq1} + I_{Dq2} = 76\text{ mA}$ (carrier stages);
 $V_{GS} = 2.46\text{ V}$ (carrier stage);
 $V_{GS} = 1.65\text{ V}$ (peaking stage).
 Test signal: 1-carrier LTE; PAR = 7.2 dB at 0.01 % probability CCDF.

- (1) $f = 2300\text{ MHz}$
- (2) $f = 2500\text{ MHz}$
- (3) $f = 2700\text{ MHz}$

Fig 9. Power gain and drain efficiency as function of output power; typical values

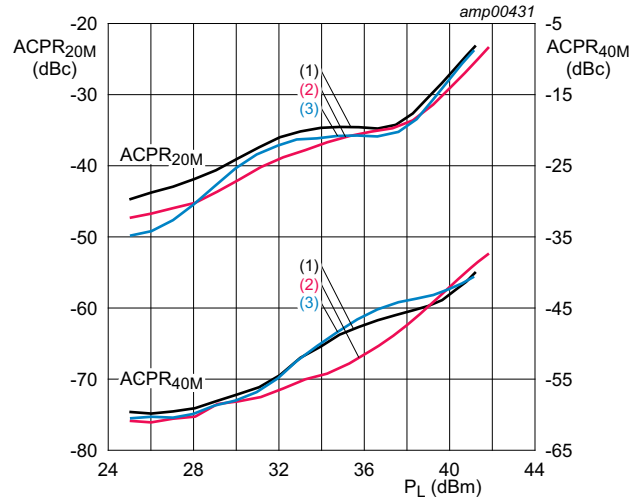

$T_{case} = 25\text{ }^{\circ}\text{C}$; $V_{DS} = 28\text{ V}$;
 $I_{Dq1} + I_{Dq2} = 76\text{ mA}$ (carrier stages);
 $V_{GS} = 2.46\text{ V}$ (carrier stage);
 $V_{GS} = 1.65\text{ V}$ (peaking stage).
 Test signal: 1-carrier LTE; PAR = 7.2 dB at 0.01 % probability CCDF.

- (1) $f = 2300\text{ MHz}$
- (2) $f = 2500\text{ MHz}$
- (3) $f = 2700\text{ MHz}$

Fig 10. Adjacent channel power ratio as a function of output power; typical values

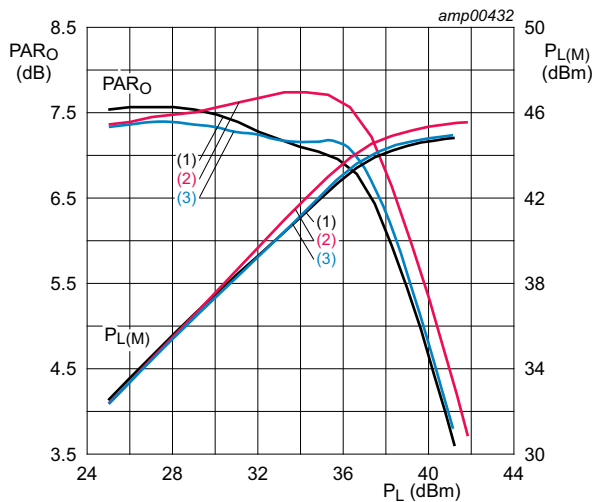

$T_{case} = 25\text{ }^{\circ}\text{C}$; $V_{DS} = 28\text{ V}$; $I_{Dq1} + I_{Dq2} = 76\text{ mA}$ (carrier stages);
 $V_{GS} = 2.46\text{ V}$ (carrier stage); $V_{GS} = 1.65\text{ V}$ (peaking stage).
 Test signal: 1-carrier LTE; PAR = 7.2 dB at 0.01 % probability CCDF.

- (1) $f = 2300\text{ MHz}$
- (2) $f = 2500\text{ MHz}$
- (3) $f = 2700\text{ MHz}$

Fig 11. Output peak-to-average ratio and peak output power as function of output power; typical values

10. Handling information

CAUTION



This device is sensitive to ElectroStatic Discharge (ESD). Observe precautions for handling electrostatic sensitive devices.

Such precautions are described in the *ANSI/ESD S20.20*, *IEC/ST 61340-5*, *JESD625-A* or equivalent standards.

Table 11. ESD sensitivity

ESD model	Class
Charged Device Model (CDM); According to ANSI/ESDA/JEDEC standard JS-002	C2A [1]
Human Body Model (HBM); According to ANSI/ESDA/JEDEC standard JS-001	1B [2]

[1] CDM classification C2A is granted to any part that passes after exposure to an ESD pulse of 500 V, but fails after exposure to an ESD pulse of 750 V.

[2] HBM classification 1B is granted to any part that passes after exposure to an ESD pulse of 500 V, but fails after exposure to an ESD pulse of 1000 V.

11. Abbreviations

Table 12. Abbreviations

Acronym	Description
3GPP	3rd Generation Partnership Project
CCDF	Complementary Cumulative Distribution Function
CW	Continuous Wave
DPCH	Dedicated Physical CHannel
ESD	ElectroStatic Discharge
GEN9	Ninth Generation
GSM	Global System for Mobile Communications
LDMOS	Laterally Diffused Metal Oxide Semiconductor
LTE	Long Term Evolution
MMIC	Monolithic Microwave Integrated Circuit
MTF	Median Time to Failure
OBO	Output Back Off
PAR	Peak-to-Average Ratio
SMD	Surface Mounted Device
VSWR	Voltage Standing-Wave Ratio
W-CDMA	Wideband Code Division Multiple Access

12. Revision history

Table 13. Revision history

Document ID	Release date	Data sheet status	Change notice	Supersedes
BLM9D2327-25B v.1	20170901	Product data sheet	-	-

13. Legal information

13.1 Data sheet status

Document status ^{[1][2]}	Product status ^[3]	Definition
Objective [short] data sheet	Development	This document contains data from the objective specification for product development.
Preliminary [short] data sheet	Qualification	This document contains data from the preliminary specification.
Product [short] data sheet	Production	This document contains the product specification.

[1] Please consult the most recently issued document before initiating or completing a design.

[2] The term 'short data sheet' is explained in section "Definitions".

[3] The product status of device(s) described in this document may have changed since this document was published and may differ in case of multiple devices. The latest product status information is available on the Internet at URL <http://www.ampleon.com>.

13.2 Definitions

Draft — The document is a draft version only. The content is still under internal review and subject to formal approval, which may result in modifications or additions. Ampleon does not give any representations or warranties as to the accuracy or completeness of information included herein and shall have no liability for the consequences of use of such information.

Short data sheet — A short data sheet is an extract from a full data sheet with the same product type number(s) and title. A short data sheet is intended for quick reference only and should not be relied upon to contain detailed and full information. For detailed and full information see the relevant full data sheet, which is available on request via the local Ampleon sales office. In case of any inconsistency or conflict with the short data sheet, the full data sheet shall prevail.

Product specification — The information and data provided in a Product data sheet shall define the specification of the product as agreed between Ampleon and its customer, unless Ampleon and customer have explicitly agreed otherwise in writing. In no event however, shall an agreement be valid in which the Ampleon product is deemed to offer functions and qualities beyond those described in the Product data sheet.

13.3 Disclaimers

Limited warranty and liability — Information in this document is believed to be accurate and reliable. However, Ampleon does not give any representations or warranties, expressed or implied, as to the accuracy or completeness of such information and shall have no liability for the consequences of use of such information. Ampleon takes no responsibility for the content in this document if provided by an information source outside of Ampleon.

In no event shall Ampleon be liable for any indirect, incidental, punitive, special or consequential damages (including - without limitation - lost profits, lost savings, business interruption, costs related to the removal or replacement of any products or rework charges) whether or not such damages are based on tort (including negligence), warranty, breach of contract or any other legal theory.

Notwithstanding any damages that customer might incur for any reason whatsoever, Ampleon's aggregate and cumulative liability towards customer for the products described herein shall be limited in accordance with the *Terms and conditions of commercial sale* of Ampleon.

Right to make changes — Ampleon reserves the right to make changes to information published in this document, including without limitation specifications and product descriptions, at any time and without notice. This document supersedes and replaces all information supplied prior to the publication hereof.

Suitability for use — Ampleon products are not designed, authorized or warranted to be suitable for use in life support, life-critical or safety-critical systems or equipment, nor in applications where failure or malfunction of an

Ampleon product can reasonably be expected to result in personal injury, death or severe property or environmental damage. Ampleon and its suppliers accept no liability for inclusion and/or use of Ampleon products in such equipment or applications and therefore such inclusion and/or use is at the customer's own risk.

Applications — Applications that are described herein for any of these products are for illustrative purposes only. Ampleon makes no representation or warranty that such applications will be suitable for the specified use without further testing or modification.

Customers are responsible for the design and operation of their applications and products using Ampleon products, and Ampleon accepts no liability for any assistance with applications or customer product design. It is customer's sole responsibility to determine whether the Ampleon product is suitable and fit for the customer's applications and products planned, as well as for the planned application and use of customer's third party customer(s). Customers should provide appropriate design and operating safeguards to minimize the risks associated with their applications and products.

Ampleon does not accept any liability related to any default, damage, costs or problem which is based on any weakness or default in the customer's applications or products, or the application or use by customer's third party customer(s). Customer is responsible for doing all necessary testing for the customer's applications and products using Ampleon products in order to avoid a default of the applications and the products or of the application or use by customer's third party customer(s). Ampleon does not accept any liability in this respect.

Limiting values — Stress above one or more limiting values (as defined in the Absolute Maximum Ratings System of IEC 60134) will cause permanent damage to the device. Limiting values are stress ratings only and (proper) operation of the device at these or any other conditions above those given in the Recommended operating conditions section (if present) or the Characteristics sections of this document is not warranted. Constant or repeated exposure to limiting values will permanently and irreversibly affect the quality and reliability of the device.

Terms and conditions of commercial sale — Ampleon products are sold subject to the general terms and conditions of commercial sale, as published at <http://www.ampleon.com/terms>, unless otherwise agreed in a valid written individual agreement. In case an individual agreement is concluded only the terms and conditions of the respective agreement shall apply. Ampleon hereby expressly objects to applying the customer's general terms and conditions with regard to the purchase of Ampleon products by customer.

No offer to sell or license — Nothing in this document may be interpreted or construed as an offer to sell products that is open for acceptance or the grant, conveyance or implication of any license under any copyrights, patents or other industrial or intellectual property rights.

Export control — This document as well as the item(s) described herein may be subject to export control regulations. Export might require a prior authorization from competent authorities.

Non-automotive qualified products — Unless this data sheet expressly states that this specific Ampleon product is automotive qualified, the product is not suitable for automotive use. It is neither qualified nor tested in accordance with automotive testing or application requirements. Ampleon accepts no liability for inclusion and/or use of non-automotive qualified products in automotive equipment or applications.

In the event that customer uses the product for design-in and use in automotive applications to automotive specifications and standards, customer (a) shall use the product without Ampleon's warranty of the product for such automotive applications, use and specifications, and (b) whenever customer uses the product for automotive applications beyond Ampleon's specifications such use shall be solely at customer's own risk, and (c) customer fully indemnifies Ampleon for any liability, damages or failed product claims resulting from customer design and use of the product for automotive applications beyond Ampleon's standard warranty and Ampleon's product specifications.

Translations — A non-English (translated) version of a document is for reference only. The English version shall prevail in case of any discrepancy between the translated and English versions.

13.4 Trademarks

Notice: All referenced brands, product names, service names and trademarks are the property of their respective owners.

Any reference or use of any 'NXP' trademark in this document or in or on the surface of Ampleon products does not result in any claim, liability or entitlement vis-à-vis the owner of this trademark. Ampleon is no longer part of the NXP group of companies and any reference to or use of the 'NXP' trademarks will be replaced by reference to or use of Ampleon's own trademarks.

14. Contact information

For more information, please visit: <http://www.ampleon.com>

For sales office addresses, please visit: <http://www.ampleon.com/sales>

15. Contents

1 Product profile 1

1.1 General description 1

1.2 Features and benefits 1

1.3 Applications 1

2 Pinning information 2

2.1 Pinning 2

2.2 Pin description 2

3 Ordering information 3

4 Block diagram 3

5 Limiting values 3

6 Thermal characteristics 4

7 Characteristics 4

8 Application information 5

8.1 Ruggedness in a Doherty operation 8

8.2 Impedance information 8

8.3 Graphs 9

9 Package outline 12

10 Handling information 13

11 Abbreviations 13

12 Revision history 13

13 Legal information 14

13.1 Data sheet status 14

13.2 Definitions 14

13.3 Disclaimers 14

13.4 Trademarks 15

14 Contact information 15

15 Contents 16

Please be aware that important notices concerning this document and the product(s) described herein, have been included in section 'Legal information'.



© Ampleon Netherlands B.V. 2017. **All rights reserved.**

For more information, please visit: <http://www.ampleon.com>
 For sales office addresses, please visit: <http://www.ampleon.com/sales>





Date of release: 1 September 2017
 Document identifier: BLM9D2327-25B

Looking for pricing, stock, or lifecycle information?

Click below to explore more details on WIN SOURCE:

-  [View BLM9D2327-25BZ on WIN SOURCE](#)
-  [Ampleon USA Inc. Information](#)

Optimize Your Supply Chain with WIN SOURCE Solutions

-  Global Sourcing Solution
-  Obsolete Management
-  Cost Control Management
-  Shortage Management
-  Alternative Solution
-  Excess Inventory Management