

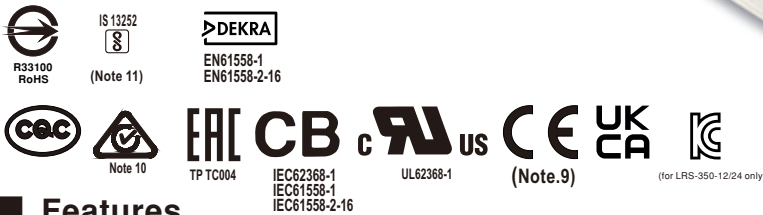

# THE DATASHEET OF LRS-350-24





■ Features

- AC input range selectable by switch
- Withstand 300VAC surge input for 5 second
- Protections: Short circuit / Overload / Over voltage / Over temperature
- Forced air cooling by built-in DC fan
- Built-in cooling Fan ON-OFF control
- 1U low profile
- Withstand 5G vibration test
- LED indicator for power on
- No load power consumption < 0.75W
- 100% full load burn-in test
- High operating temperature up to 70°C
- Operating altitude up to 5000 meters (Note.8)
- High efficiency, long life and high reliability
- 3 years warranty

■ Applications

- Industrial automation machinery
- Industrial control system
- Mechanical and electrical equipment
- Electronic instruments, equipments or apparatus

■ GTIN CODE

MW Search: <https://www.meanwell.com/serviceGTIN.aspx>

■ Description

LRS-350 series is a 350W single-output enclosed type power supply with 30mm of low profile design. Adopting the input of 115VAC or 230VAC (select by switch), the entire series provides an output voltage line of 3.3V, 4.2V, 5V, 12V, 15V, 24V, 36V and 48V.

In addition to the high efficiency up to 89%, with the built-in long life fan LRS-350 can work under -25~+70°C with full load. Delivering an extremely low no load power consumption (less than 0.75W), it allows the end system to easily meet the worldwide energy requirement. LRS-350 has the complete protection functions and 5G anti-vibration capability; it is complied with the international safety regulations such as IEC/UL 62368-1. LRS-350 series serves as a high price-to-performance power supply solution for various industrial applications.

■ Model Encoding

LRS - 350 - 3.3

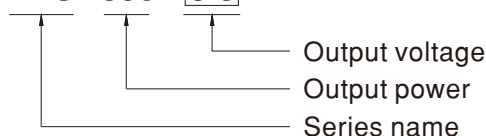

**SPECIFICATION**

MODEL	LRS-350-3.3	LRS-350-4.2	LRS-350-5	LRS-350-12	LRS-350-15	LRS-350-24	LRS-350-36	LRS-350-48	
OUTPUT	DC VOLTAGE	3.3V	4.2V	5V	12V	15V	24V	36V	48V
	RATED CURRENT	60A	60A	60A	29A	23.2A	14.6A	9.7A	7.3A
	CURRENT RANGE	0 ~ 60A	0 ~ 60A	0 ~ 60A	0 ~ 29A	0 ~ 23.2A	0 ~ 14.6A	0 ~ 9.7A	0 ~ 7.3A
	RATED POWER	198W	252W	300W	348W	348W	350.4W	349.2W	350.4W
	RIPPLE & NOISE (max.) Note.2	150mVp-p	150mVp-p	150mVp-p	150mVp-p	150mVp-p	150mVp-p	200mVp-p	200mVp-p
	VOLTAGE ADJ. RANGE	2.97 ~ 3.6V	3.6 ~ 4.4V	4.5 ~ 5.5V	10.2 ~ 13.8V	13.5 ~ 18V	21.6 ~ 28.8V	32.4 ~ 39.6V	43.2 ~ 52.8V
	VOLTAGE TOLERANCE Note.3	±4.0%	±4.0%	±3.0%	±1.5%	±1.0%	±1.0%	±1.0%	±1.0%
	LINE REGULATION Note.4	±0.5%	±0.5%	±0.5%	±0.5%	±0.5%	±0.5%	±0.5%	±0.5%
	LOAD REGULATION Note.5	±2.5%	±2.5%	±2.0%	±1.0%	±0.5%	±0.5%	±0.5%	±0.5%
	SETUP, RISE TIME	1300ms, 50ms/230VAC      1300ms, 50ms/115VAC at full load							
HOLD UP TIME (Typ.)	16ms/230VAC      12ms/115VAC at full load								
INPUT	VOLTAGE RANGE	90 ~ 132VAC / 180 ~ 264VAC by switch      240 ~ 370VDC (switch on 230VAC)							
	FREQUENCY RANGE	47 ~ 63Hz							
	EFFICIENCY (Typ.)	79.5%	81.5%	83.5%	85%	86%	88%	88.5%	89%
	AC CURRENT (Typ.)	6.8A/115VAC		3.4A/230VAC					
	INRUSH CURRENT (Typ.)	60A/115VAC		60A/230VAC					
	LEAKAGE CURRENT	<2mA / 240VAC							
PROTECTION	OVER LOAD	110 ~ 140% rated output power 3.3~36V Hiccup mode, recovers automatically after fault condition is removed. 48V Shut down and latch off o/p voltage, re-power on to recover.							
	OVER VOLTAGE	3.8 ~ 4.45V	4.6 ~ 5.4V	5.75 ~ 6.75V	13.8 ~ 16.2V	18 ~ 21V	28.8 ~ 33.6V	41.4 ~ 46.8V	55.2 ~ 64.8V
	OVER TEMPERATURE	3.3~36V Hiccup mode, recovers automatically after fault condition is removed. 48V Shut down and latch off o/p voltage, re-power on to recover.							
FUNCTION	FAN ON/OFF CONTROL (Typ.)	RTH3 ≥ 50°C FAN ON, ≤ 40°C FAN OFF							
ENVIRONMENT	WORKING TEMP.	-25 ~ +70°C (Refer to "Derating Curve")							
	WORKING HUMIDITY	20 ~ 90% RH non-condensing							
	STORAGE TEMP., HUMIDITY	-40 ~ +85°C, 10 ~ 95% RH							
	TEMP. COEFFICIENT	±0.03%/°C (0 ~ 50°C)							
	VIBRATION	10 ~ 500Hz, 5G 10min./1cycle, 60min. each along X, Y, Z axes							
	OVER VOLTAGE CATEGORY	III: According to EN61558, EN50178, EN60664-1, EN62477-1; altitude up to 2000 meters							
SAFETY	SAFETY STANDARDS	IEC/UL 62368-1, BSMI CNS15598-1, EAC TP TC 004, KC62368-1(for LRS-350-12/24 only), GB 4943.1, BIS IS13252(Part1): 2010/IEC 60950-1: 2005(NOTE 11), BS EN/EN61558-1, BS EN61558-2-16 Designed by AS/NZS 61558.1/2.16, AS/NZS 62368.1, BS EN/EN62368-1,							
	WITHSTAND VOLTAGE	I/P-O/P: 3.75KVAC		I/P-FG: 2KVAC		O/P-FG: 0.5KVAC			
	ISOLATION RESISTANCE	I/P-O/P, I/P-FG, O/P-FG: 100M Ohms/500VDC / 25°C / 70% RH							
	EMC EMISSION	Compliance to BSMI CNS15936, EAC TP TC 020, KS C 9832, KS C 9835(for LRS-350-12/24 only)							
	EMC IMMUNITY	Compliance to BS EN/EN55035, EAC TP TC 020, KS C 9832, KS C 9835(for LRS-350-12/24 only)							
OTHERS	MTBF	2099.9K hrs min. Telcordia SR-332 (Bellcore); 328.6Khrs min. MIL-HDBK-217F (25°C)							
	DIMENSION	215*115*30mm (L*W*H)							
	PACKING	0.76Kg; 15pcs/12.4Kg/0.67CUFT							
NOTE	<p>1. All parameters NOT specially mentioned are measured at 230VAC input, rated load and 25°C of ambient temperature.</p> <p>2. Ripple &amp; noise are measured at 20MHz of bandwidth by using a 12" twisted pair-wire terminated with a 0.1uf &amp; 47uf parallel capacitor.</p> <p>3. Tolerance : includes set up tolerance, line regulation and load regulation.</p> <p>4. Line regulation is measured from low line to high line at rated load.</p> <p>5. Load regulation is measured from 0% to 100% rated load.</p> <p>6. Length of set up time is measured at cold first start. Turning ON/OFF the power supply very quickly may lead to increase of the set up time.</p> <p>7. The 150% peak load capability is built in for up to 1 second for 12~48V.LRS-350 will enter hiccup mode if the peak load is delivered for over 1 second and will recover once it resumes to the rated current level(115VAC/230VAC).</p> <p>8. The ambient temperature derating of 5°C/1000m is needed for operating altitude greater than 2000m(6500ft).</p> <p>9. This power supply does not meet the harmonic current requirements outlined by BS EN/EN61000-3-2. Please do not use this power supply under the following conditions:</p> <ul style="list-style-type: none"> <li>a) the end-devices is used within the European Union, and</li> <li>b) the end-devices is connected to public mains supply with 220Vac or greater rated nominal voltage, and</li> <li>c) the power supply is: <ul style="list-style-type: none"> <li>- installed in end-devices with average or continuous input power greater than 75W, or</li> <li>- belong to part of a lighting system</li> </ul> </li> </ul> <p>Exception: Power supplies used within the following end-devices do not need to fulfill BS EN/EN61000-3-2</p> <ul style="list-style-type: none"> <li>a) professional equipment with a total rated input power greater than 1000W;</li> <li>b) symmetrically controlled heating elements with a rated power less than or equal to 200W</li> </ul> <p>10. RCM is on voluntary basis and meets relevant IEC or AS/NZS standards complying with AS/NZS 4417.1.</p> <p>11. Some model may not have the BIS logo, please contact your MEAN WELL sales for more information.</p> <p>※ Product Liability Disclaimer : For detailed information, please refer to <a href="https://www.meanwell.com/serviceDisclaimer.aspx">https://www.meanwell.com/serviceDisclaimer.aspx</a></p>								

■ Block Diagram

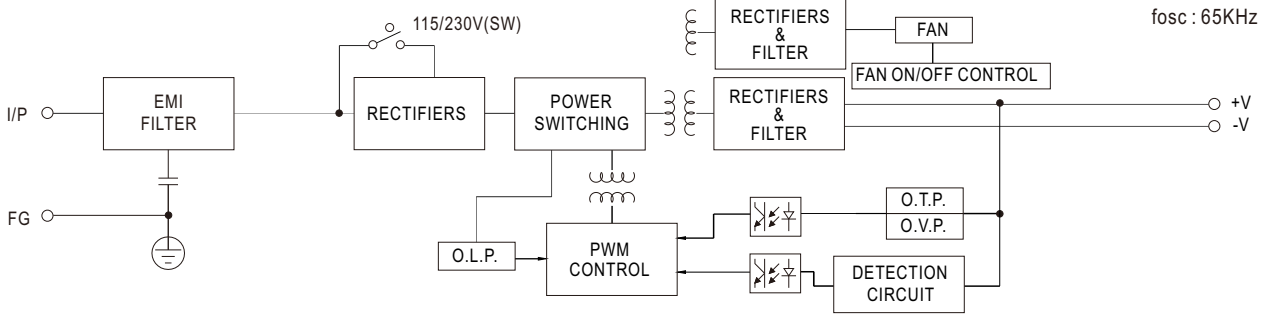

■ Derating Curve

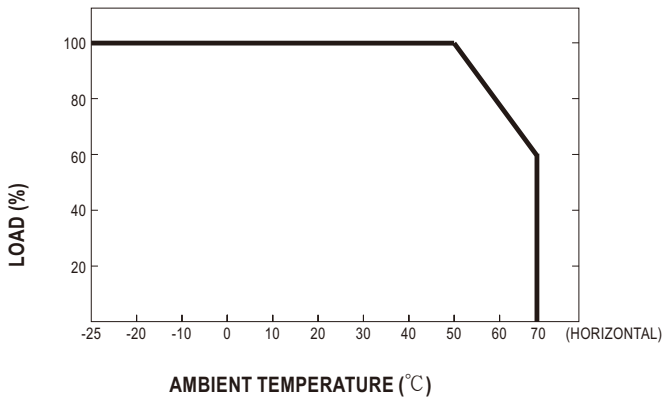

■ Static Characteristics

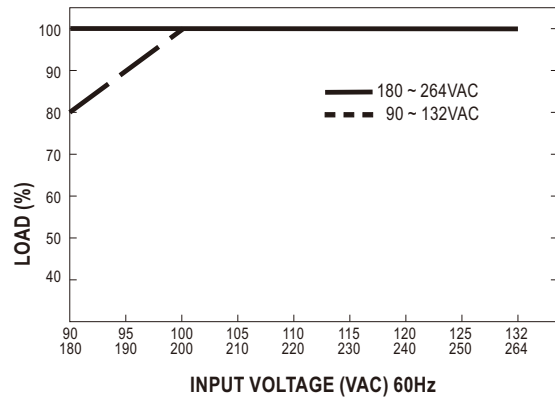

**Mechanical Specification**

Case No.207A Unit:mm

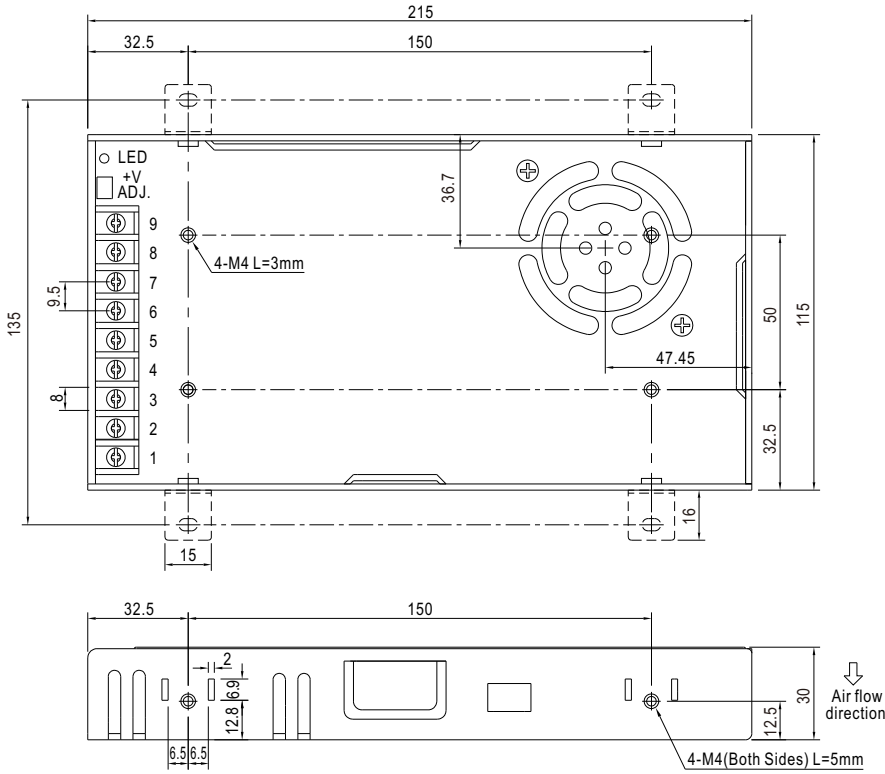

Terminal Pin No. Assignment :



Pin No.	Assignment	Pin No.	Assignment
1	AC/L	4~6	DC OUTPUT -V
2	AC/N	7~9	DC OUTPUT +V
3	FG $\perp$		

**Installation Manual**

Please refer to : <http://www.meanwell.com/manual.html>

## Looking for pricing, stock, or lifecycle information?

Click below to explore more details on WIN SOURCE:

-  [View LRS-350-24 on WIN SOURCE](#)
-  [Mean Well Enterprises Co., Ltd. Information](#)

## Optimize Your Supply Chain with WIN SOURCE Solutions

-  Global Sourcing Solution
-  Obsolete Management
-  Cost Control Management
-  Shortage Management
-  Alternative Solution
-  Excess Inventory Management