



**THE DATASHEET OF
SD3421-002**



SD3421/5421

Silicon PIN Photodiode

FEATURES

- TO-46 metal can package
- Choice of flat window or lensed package
- 90° or 18° (nominal) acceptance angle option
- Fast response time
- Wide operating temperature range (-55°C to +125°C)
- Mechanically and spectrally matched to SE3450/5450, SE3455/5455 and SE3470/5470 infrared emitting diodes

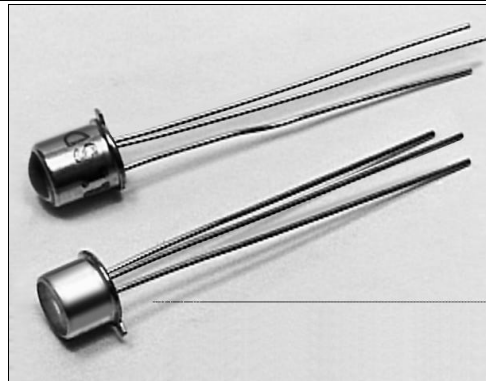

INFRA-57.TIF

DESCRIPTION

The SD3421/5421 series consists of PIN photodiodes mounted in a TO-46 metal can package. The SD3421 utilizes flat window cans providing a wide acceptance angle, while the SD5421 employs glass lensed cans providing a narrow acceptance angle. The TO-46 packages are ideally suited for operation in hostile environments.

OUTLINE DIMENSIONS in inches (mm)

Tolerance	3 plc decimals	±0.005(0.12)
	2 plc decimals	±0.020(0.51)

SD3421

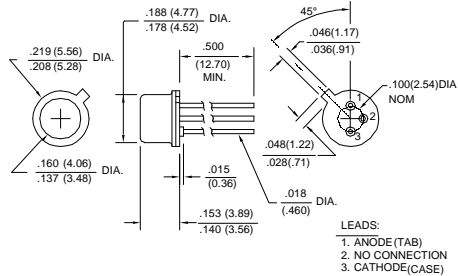

SD5421

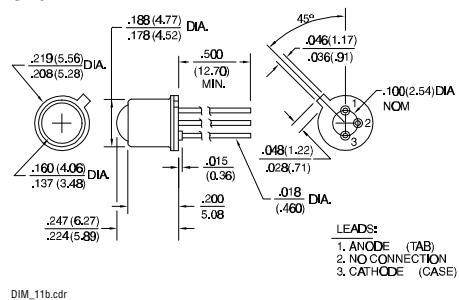

SD3421/5421

Silicon PIN Photodiode

ELECTRICAL CHARACTERISTICS (25°C unless otherwise noted)

PARAMETER	SYMBOL	MIN	TYP	MAX	UNITS	TEST CONDITIONS
Light Current SD3421-002 SD5421-002	I_L	10.0 40.0			μA	$V_R=20\text{ V}$ $H=5\text{ mW/cm}^2$ (1)
Dark Current	I_D			20	nA	$V_R=20\text{ V}$ $H=0$
Reverse Breakdown Voltage	V_{BR}	75			V	$I_R=10\ \mu\text{A}$
Angular Response (2) SD3421 SD5421	\emptyset		90 18		degr.	$I_F=\text{Constant}$
Rise And Fall Time	t_r, t_f		15		ns	$V_R=20\text{ V}$ $R_L=50\ \Omega$

Notes

- The radiation source is a tungsten lamp operating at a color temperature of 2870°K.
- Angular response is defined as the total included angle between the half sensitivity points.

ABSOLUTE MAXIMUM RATINGS

(25°C Free-Air Temperature unless otherwise noted)

Cathode Anode Voltage	75 V
Power Dissipation	150 mW (1)
Operating Temperature Range	-55°C to 125°C
Storage Temperature Range	-65°C to 150°C
Soldering Temperature (10 sec)	260°C

Notes

- Derate linearly from 25°C free-air temperature at the rate of 1.43 mW/°C.

SCHEMATIC

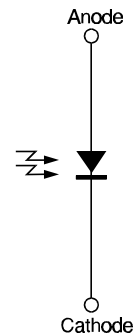

Honeywell reserves the right to make changes in order to improve design and supply the best products possible.

Honeywell

SD3421/5421

Silicon PIN Photodiode

SWITCHING TIME TEST CIRCUIT

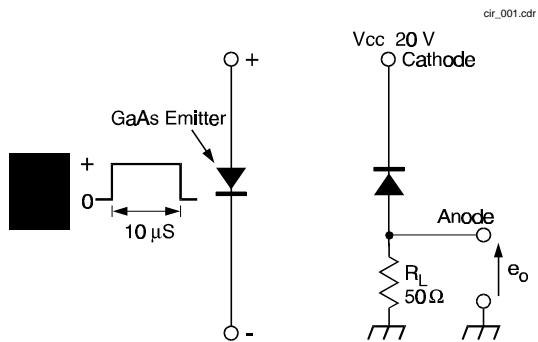
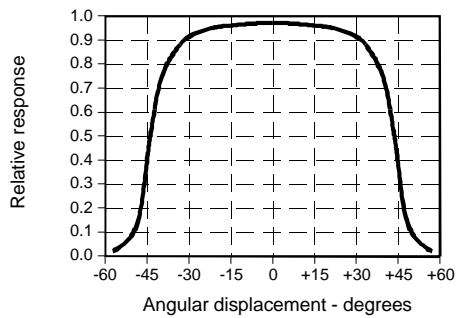

Fig. 1 Responsivity vs Angular Displacement (SD3421) gra_052.ds4



SWITCHING WAVEFORM

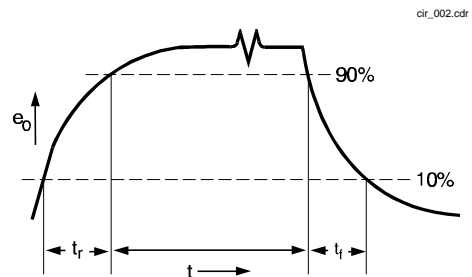

Fig. 2 Responsivity vs Angular Displacement (SD5421) gra_053.ds4

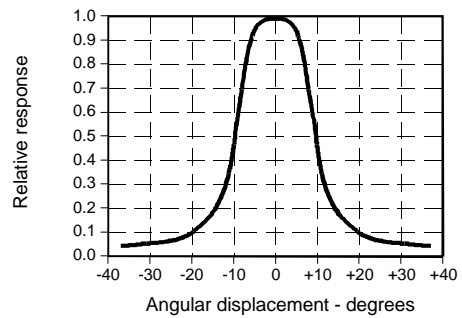

Fig. 3 Dark Current vs Temperature gra_038.ds4

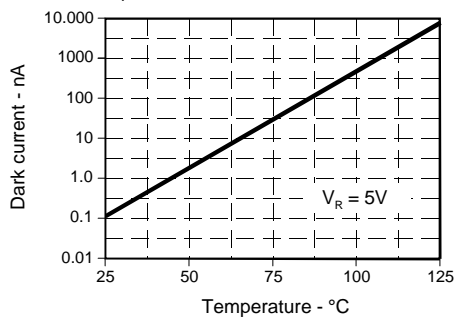
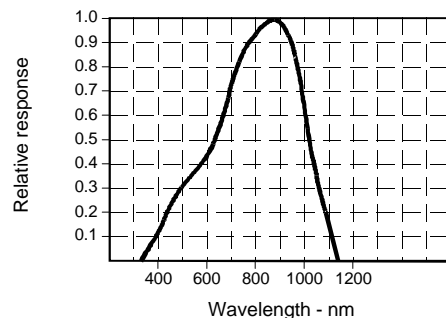

Fig. 4 Spectral Responsivity gra_036.ds4



All Performance Curves Show Typical Values

SD3421/5421
Silicon PIN Photodiode





Honeywell reserves the right to make changes in order to improve design and supply the best products possible.

Honeywell

Looking for pricing, stock, or lifecycle information?

Click below to explore more details on WIN SOURCE:

-  [View SD3421-002 on WIN SOURCE](#)
-  [Honeywell Information](#)

Optimize Your Supply Chain with WIN SOURCE Solutions

-  Global Sourcing Solution
-  Obsolete Management
-  Cost Control Management
-  Shortage Management
-  Alternative Solution
-  Excess Inventory Management