



**THE DATASHEET OF
R-78C5.0-1.0**



Features

Switching Regulator

- Efficiency up to 96%, no need for heatsinks
- Pin-out compatible with LM78XX linears
- Low profile (L*W*H=11.6*8.5*10.4mm)
- Wide input range (5V - 42V)
- Short circuit protection, thermal shutdown
- Low ripple and noise
- IEC/EN60950 certified
- Positive to negative converter

RECOM DC/DC Converter

R-78C-1.0

1.0 Amp
SIP3
Single Output



Description

The R-78Cxx-1.0 series switching regulators are ideally suited to replace 1 Amp 78xx linear regulators and are pin compatible. Efficiencies of up to 96% means that very little energy is wasted as heat and the high input voltage is a useful feature.

Selection Guide

Part Number	Input Voltage Range [VDC]	Output Voltage [VDC]	Output Current [A]	Efficiency	
				@ min Vin [%]	@ max. Vin [%]
R-78C1.8-1.0	5 - 42	1.8	1.0	80	71
R-78C3.3-1.0	7 - 42	3.3	1.0	89	79
R-78C5.0-1.0	8 - 42	5	1.0	93	85
R-78C9.0-1.0	12 - 42	9	1.0	95	90
R-78C12-1.0	15 - 42	12	1.0	96	92
R-78C15-1.0	18 - 42	15	1.0	96	94

Model Numbering

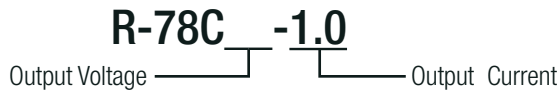

Specifications (measured at Ta= 25°C, minimum load, otherwise specified)

BASIC CHARACTERISTICS					
Parameter	Condition		Min.	Typ.	Max.
Input Voltage Range			Vout +3V		42VDC
Output Voltage Range			1.8VDC		15VDC
Minimum Load ⁽¹⁾			0%		
Quiescent Current				1mA	
Internal Operating Frequency			280kHz	350kHz	420kHz
Output Ripple and Noise ⁽²⁾	20MHz BW	Vin= 24VDC Vout=1.8-15 full load		75mVp-p 30mVp-p	120mVp-p
Max. Capacitive Load	with normal start-up time, no external components with <1 second start-up time + diode protection circuit				470µF 6800µF
Notes:					
Note1: No load operation will not damage these devices, however they may not meet all specifications A minimum load of 10mA is required					
Note2: Measurements are made with a 10µF MLCC across output. (low ESR)					

REGULATIONS

Parameter	Condition	Value
Output Voltage Accuracy	full load	±2% typ. / ±3% max.
Line Voltage Regulation	max. Vin, full load	±0.2% typ.
Load Voltage Regulation	max. Vin. and 10% to 100% load	±0.4% typ.
Transient Response	100% <-> 50% load	±75mV max.
	100% <-> 10% load	±200mV max.



IEC60950-1 certified
EN60950-1 certified
EN55032 compliant

Specifications (measured at Ta= 25°C, minimum load, otherwise specified)

PROTECTIONS		
Parameter	Condition	Value
Short Circuit Protection (SCP)		continuous, automatic recovery
Short Circuit Input Current	nom. Vin = 24VDC	65mA typ.

External Zener Diode Calculation for Output Over Voltage Protection

Minimum Zener Breakdown Voltage (VZmin) ≥ VOUTnom + 3% Accuracy

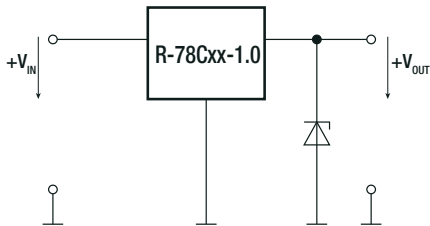

R-78C Vout	Zener Voltage, Vz (VZmin)	Recommended Zener Diode
1.8V (1.85V max.)	2.0V (1.90V)	MMSZ679T1G
3.3V (3.4V max.)	3.6V (3.42V)	MMSZ4685T1G
5V (5.15V max.)	5.6V (5.32V)	MMSZ4690T1G
9V (9.27V max.)	10V (9.50V)	MMSZ4697T1G
12V (12.36V max.)	13V (12.35V) 14V (13.30V)	MMSZ4700T1G / MMSZ4701T1G
15V (15.45V max.)	17V (16.15V)	MMSZ4704T1G

ENVIRONMENTAL			
Parameter	Condition	Value	
Operating Temperature Range	with derating (see graph)	-40°C to +85°C	
Max. Case Temperature		+100°C	
Temperature Coefficient		0.015%/°C	
Case Thermal Impedance		70°C/W max.	
Operating Altitude		2000m	
Operating Humidity	non condensing	5% - 95% max., RH	
Pollution Degree		PD2	
MTBF	MIL-HDBK 217F	+25°C	8600 x 10 ³ hours
		+68°C	3880 x 10 ³ hours

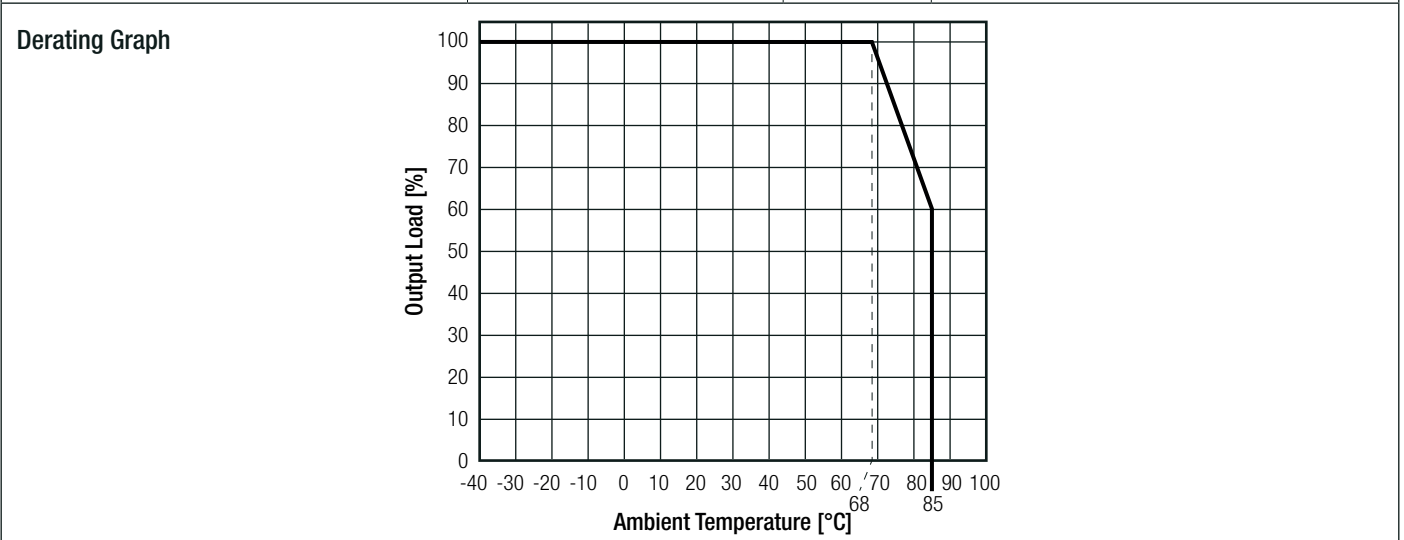

SAFETY AND CERTIFICATIONS		
Certificate Type (Safety)	Report / File Number	Standard
Information Technology Equipment, General Requirements for Safety	1603123	IEC60950-1:2005, 2nd Edition + AM 2:2013 EN60950-1:2006 + AM2:2013
RoHS 2+		RoHS 2011/65/EU + AM2015/863
EAC	RU-AT.49.09571	TP TC 004/2011

continued on next page

Specifications (measured at Ta= 25°C, minimum load, otherwise specified)

EMC Compliance	Condition	Standard / Criterion
Electromagnetic compatibility of multimedia equipment - Emission requirements	with external filter (see filter suggestion below)	EN55032, Class A and B

EMC Filter Suggestion according to EN55032

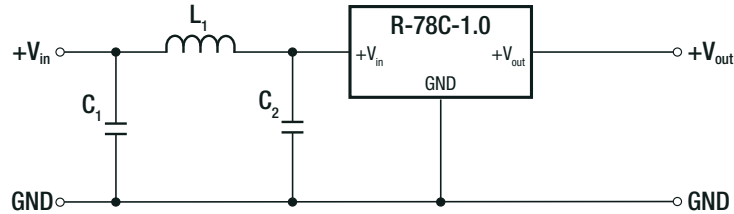

Component List Class A

MODEL	C1	L1
R-78C3.3-1.0	10µF	5.6µH choke
R-78C5.0-1.0	100V MLCC	RLS-567

Component List Class B

MODEL	C1	C2	L1
R-78C3.3-1.0	10µF	10µF	12µH choke
R-78C5.0-1.0	100V MLCC	100V MLCC	RLS-126

Notes:

Note3: Filter suggestions are valid for indicated part numbers only. For other part numbers, please contact RECOM tech support for advice

DIMENSION AND PHYSICAL CHARACTERISTICS

Parameter		Value
Material	case potting	non-conductive black plastic, (UL94 V-0) silicone, (UL94 V-0)
Package Dimension (LxWxH)		11.6 x 8.5 x 10.4mm
Package Weight		2g typ.

Dimension Drawing (mm)

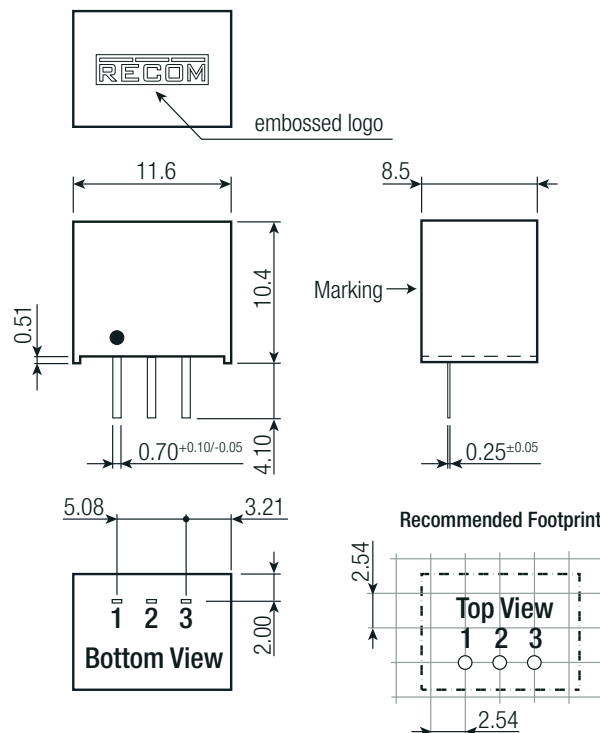

Pin Connections

Pin #	Function
1	+Vin
2	GND
3	+Vout

Tolerance: xx.x= ±0.50mm
xx.xx= ±0.25mm

Specifications (measured at Ta= 25°C, minimum load, otherwise specified)

INSTALLATION AND APPLICATION

Positive to Negative Converter

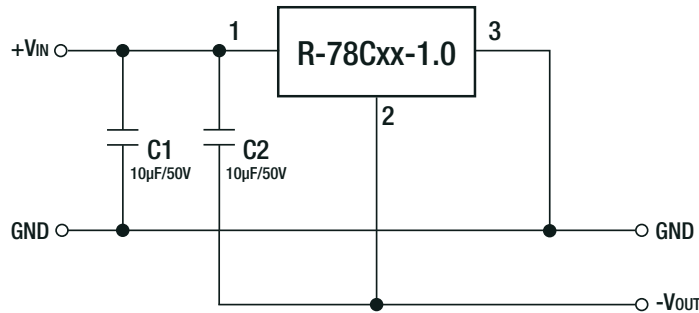

Pin Connections

Pin #	Negative	Positive
1	+Vin	+Vin
2	-Vout	GND
3	GND	+Vout

Selection Guide - Negative Output

Part Number	Input Voltage Range ⁽³⁾ [VDC]	Output Voltage [VDC]	Output Current [A]	Efficiency	
				@ min Vin [%]	@ max. Vin [%]
R-78C1.8-1.0	5 - 38	-1.8	-0.8	69	70
R-78C3.3-1.0	7 - 37	-3.3	-0.8	77	80
R-78C5.0-1.0	8 - 35	-5	-0.7	79	83
R-78C9.0-1.0	12 - 31	-9	-0.6	85	87
R-78C12-1.0	15 - 28	-12	-0.5	87	89
R-78C15-1.0	18 - 25	-15	-0.5	89	90

Notes:

Note4: When using the R-78C as positive-to-negative converter, the input voltage range is limited

Dual Output (two Converters) with Negative Output

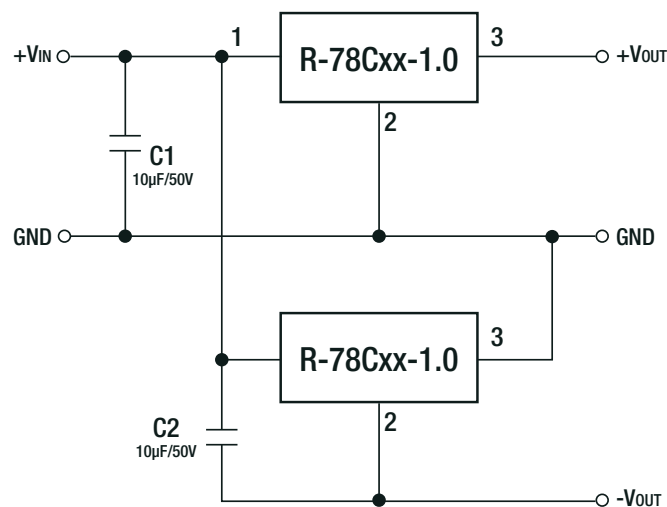

Notes:

Note5: When connecting two R-78C together to create a dual output, both connectors must be connected in parallel. Connecting them in series might cause start-up problems of the second R-78C

Specifications (measured at Ta= 25°C, minimum load, otherwise specified)

High Efficiency Regulated Outputs

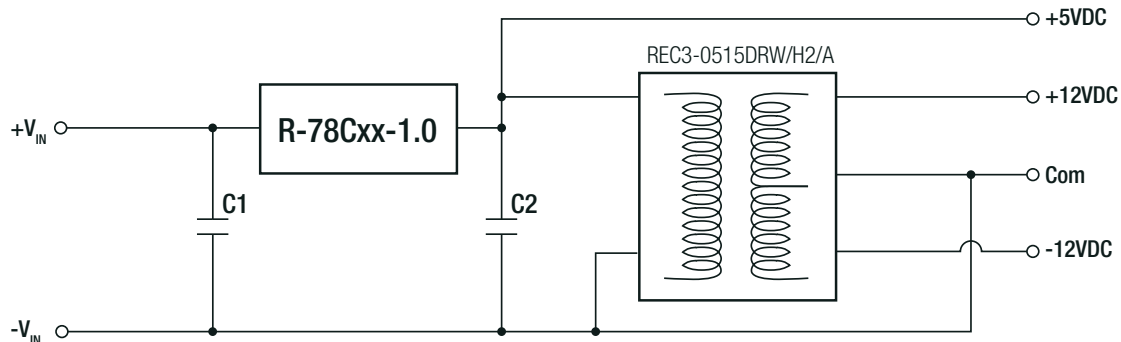

C1: optional; C2: Required (further decoupling filtering may be necessary between the two converters)

- Triple Outputs
- Wide Input Range 8V to 42V
- High System Efficiency, Suitable for 12V, 24V, 36V Battery Powered Devices

Standard Application Circuit

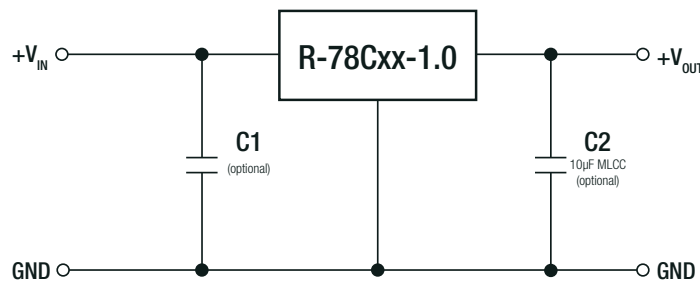

To protect the converter during power-up, use soft start power supply.

Low Voltage AC Input, Regulated DC Output

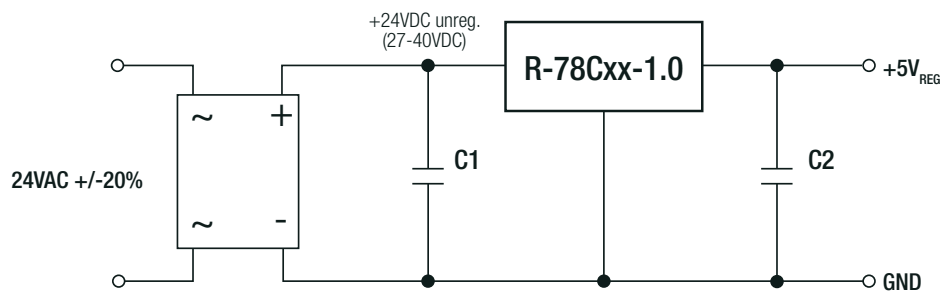

- Low Voltage AC Input
- Regulated and protected DC Output



PACKAGING INFORMATION

Parameter	Type	Value
Packaging Dimension (LxWxH)	tube	520 x 18.2 x 11.2mm
Packaging Quantity		42pcs
Storage Temperature Range		-55°C to +125°C

The product information and specifications may be subject to changes even without prior written notice. The product has been designed for various applications; its suitability lies in the responsibility of each customer. The products are not authorized for use in safety-critical applications without RECOM's explicit written consent. A safety-critical application is an application where a failure may reasonably be expected to endanger or cause loss of life, inflict bodily harm or damage property. The applicant shall indemnify and hold harmless RECOM, its affiliated companies and its representatives against any damage claims in connection with the unauthorized use of RECOM products in such safety-critical applications.

Looking for pricing, stock, or lifecycle information?

Click below to explore more details on WIN SOURCE:

-  [View R-78C5.0-1.0 on WIN SOURCE](#)
-  [Recom Power Information](#)

Optimize Your Supply Chain with WIN SOURCE Solutions

-  Global Sourcing Solution
-  Obsolete Management
-  Cost Control Management
-  Shortage Management
-  Alternative Solution
-  Excess Inventory Management