



# THE DATASHEET OF LXH8-PW50





LUXEON A

*Freedom From Binning*  
*Hot Tested*  
*Superior Quality of Light*

Technical Datasheet DS100

**LUXEON**  
NEVER BEFORE POSSIBLE



# LUXEON<sup>®</sup> A

## Freedom From Binning

### Introduction

LUXEON<sup>®</sup> A brings Illumination Grade LED light sources to the lighting market. It has never been simpler to design LED solutions and bring them to market. With hot testing and color binning, every LUXEON A is tested and specified at real world operating conditions,  $T_j$  85°C. With *Freedom From Binning*, every LUXEON A LED falls within a single 3 step MacAdam ellipse centered on the black body curve and now, luminaire manufacturers can be confident in color consistency from LED to LED. There's never been a more supportable and consistent light emitting diode. The superior quality of light, light output, and real world efficacy enable leading performance and efficient solution development in a wide variety of segments including retrofit bulbs, office, hospitality, school, and home lighting.

- *Freedom From Binning* for superior quality of light
- Hot tested and color binned at  $T_j$  85°C
- Maximum light output and lowest cost of light
- Specified color over angle
- Simplified design and accelerated time to market.

**PHILIPS**  
**LUMILEDS**

# Table of Contents

General Product Information .....	3
Product Nomenclature.....	3
Lumen Maintenance .....	3
Environmental Compliance.....	3
Product Selection .....	4
Product Selection Guide for LUXEON A Emitters .....	4
Optical Characteristics .....	5
Electrical Characteristics.....	6
Absolute Maximum Ratings.....	7
JEDEC Moisture Sensitivity .....	7
Reflow Soldering Characteristics .....	8
Mechanical Dimensions .....	9
Pad Configuration .....	10
Solder Pad Design.....	10
Relative Spectral Distribution vs. Wavelength Characteristics .....	11
Typical Light Output Characteristics over Temperature.....	14
Typical Forward Current Characteristics.....	15
Current Derating Curves.....	16
Typical Radiation Patterns.....	18
Typical $du'$ versus $dv'$ Characteristic Versus Angle .....	19
Emitter Pocket Tape Packaging.....	20
Emitter Reel Packaging .....	21
Product Binning and Labeling .....	22
Luminous Flux Bins.....	23
LUXEON A 3-step MacAdam Ellipse Color Definition.....	24
Forward Voltage Bins.....	25

# General Product Information

## Product Nomenclature

LUXEON A emitters are tested and binned “hot” under conditions comparable to those found in “real-world” lighting products. The test conditions for LUXEON A are 700 mA D.C. with junction temperature at 85°C.

The part number designation for the LUXEON A emitters is explained as follows:

L X H A - B C D E

Where:

- A — designates minimum CRI performance (value 8 = 80 minimum and value 9 = 90 minimum)
- B — designates radiation pattern (value P for Lambertian)
- C — designates color (value W = White)
- D & E — designates nominal ANSI CCT (value 27 = 2700K, 30 = 3000K, 40 = 4000K and 50 = 5000K)

Therefore products tested and binned at 700 mA follow the part numbering scheme:

L X H x - P W x x

## Lumen Maintenance

LUXEON A products are tested in compliance with LM-80. Please visit <http://www.philipslumileds.com/support/documentation/lumen-maintenance> or contact your local Philips Lumileds Technical Solutions Manager for TM-21 extrapolations or other support.

## Environmental Compliance

Philips Lumileds is committed to providing environmentally friendly products to the solid-state lighting market. LUXEON A is compliant to the European Union directives on the restriction of hazardous substances in electronic equipment, namely the RoHS and REACH directives. Philips Lumileds will not intentionally add the following restricted materials to the LUXEON A: lead, mercury, cadmium, hexavalent chromium, polybrominated biphenyls (PBB) or polybrominated diphenyl ethers (PBDE).

# Product Selection

## Product Selection Guide for LUXEON A Emitters Junction Temperature = 85°C

**Table I.**

Typical Performance Characteristics at 350 mA, 700 mA, and 1000 mA for LUXEON A, Junction Temperature = 85°C															
Part Number	Nominal ANSI CCT	CRI @ 700 mA		Lum Flux (lm)			Typ. Lum Flux (lm)			Typ. Forward Voltage (V)			Typ. Efficacy (lm/W)		
		Min.	Typ.	Min. @ 700 mA	@ 350 mA	@ 700 mA	@ 1000 mA	@ 350 mA	@ 700 mA	@ 1000 mA	@ 350 mA	@ 700 mA	@ 1000 mA		
LXH8-PW27	2700K	80	85	140	89	160	218	2.72	2.81	2.85	93	81	76		
LXH8-PW30	3000K	80	85	150	97	174	237	2.72	2.81	2.85	102	88	83		
LXH9-PW30	3000K	90	95	120	75	135	184	2.72	2.81	2.85	79	69	64		
LXH8-PW40	4000K	80	85	160	102	183	249	2.72	2.81	2.85	107	93	87		
LXH8-PW50	5000K	80	85	170	106	190	258	2.72	2.81	2.85	111	97	91		

# Optical Characteristics

## LUXEON A at Test Current <sup>[1]</sup> Junction Temperature = 85°C

**Table 2.**

Nominal ANSI CCT	Part Number	Color Temperature CCT Typical	Typical Total Included Angle <sup>[2]</sup> (degrees) $\theta_{0.90V}$	Typical Viewing Angle <sup>[3]</sup> (degrees) 2 $\theta$ 1/2
2700K	LXH8-PW27	2725K	160	120
3000K	LXH8-PW30	3045K	160	120
3000K	LXH9-PW30	3045K	160	120
4000K	LXH8-PW40	3985K	160	120
5000K	LXH8-PW50	5028K	160	120

**Notes for Table 2:**

1. Test current is 700 mA D.C. for all LXH8-PWxx emitters.
2. Total angle at which 90% of total luminous flux is captured.
3. Viewing angle is the off axis angle from lamp centerline where the luminous intensity is 1/2 of the peak value.

# Electrical Characteristics

## Electrical Characteristics at 700 mA for LUXEON A Junction Temperature = 85°C

**Table 3.**

Nominal ANSI CCT	Forward Voltage $V_f$ <sup>[1]</sup> (V)		Typical Temperature Coefficient of Forward Voltage <sup>[2]</sup> (mV/°C) $\Delta V_f / \Delta T_J$	Typical Thermal Resistance Junction to Thermal Pad (°C/W) $R\theta_{j-c}$
	Min.	Max.		
2700K	2.5	3.5	-1.8 to -2.4	6
3000K	2.5	3.5	-1.8 to -2.4	6
4000K	2.5	3.5	-1.8 to -2.4	6
5000K	2.5	3.5	-1.8 to -2.4	6

Notes for Table 3:

1. Philips Lumileds maintains a tolerance of  $\pm 0.06V$  on forward voltage measurements.
2. Measured between  $T_J = 25^\circ C$  and  $T_J = 110^\circ C$  at  $I_f = 700$  mA.

## Absolute Maximum Ratings

**Table 4.**

Parameter	LUXEON A
DC Forward Current (mA)	1000 <sup>[2]</sup>
Peak Pulsed Forward Current (mA)	1200 <sup>[3]</sup>
ESD Sensitivity	< 8000V Human Body Model (HBM) Class 3A JESD22-A114-E
LED Junction Temperature <sup>[1]</sup>	150°C
Operating Case Temperature at 700 mA	-40°C - 135°C
Storage Temperature	-40°C - 135°C
Soldering Temperature	JEDEC 020c 260°C
Allowable Reflow Cycles	3
Reverse Voltage (Vr)	LUXEON A LEDs are not designed to be driven in reverse bias

Notes for Table 4:

1. Proper current derating must be observed to maintain junction temperature below the maximum. For additional information on thermal measurement guidelines please refer to Application Brief AB33.
2. Residual periodic variations due to power conversion from alternating current (AC) to direct current (DC), also called ‘ripple’, with frequencies  $\geq 100$  Hz and amplitude  $\leq 200$  mA are acceptable, assuming the average current throughout each cycle does not exceed 1000 mA.
3. Pulsed operation with a peak drive current of 1200 MA is acceptable if the pulse on-time is  $\leq 5$  ms per cycle and the duty cycle is  $\leq 50\%$ .

## JEDEC Moisture Sensitivity

**Table 5.**

Level	Floor Life		Soak Requirements	
	Time	Conditions	Standard	
			Time	Conditions
1	unlimited	$\leq 30^\circ\text{C}$ / 85% RH	168h + 5 / -0	85°C / 85% RH

# Reflow Soldering Characteristics

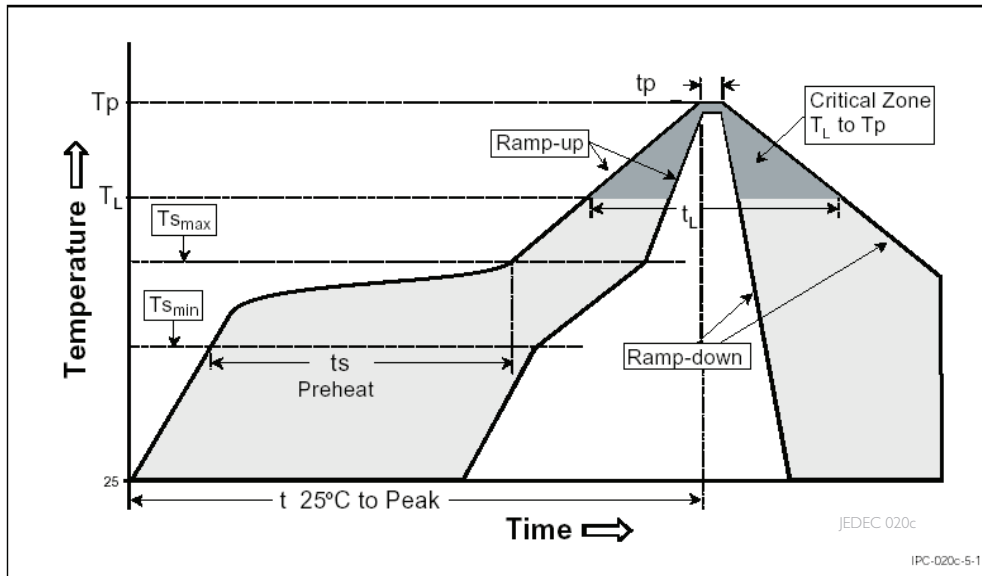

Temperature Profile for Table 6.

Table 6.

Profile Feature	Lead Free Assembly
Average Ramp-Up Rate ( $T_{s_{max}}$ to $T_p$ )	3°C / second max
Preheat Temperature Min ( $T_{s_{min}}$ )	150°C
Preheat Temperature Max ( $T_{s_{max}}$ )	200°C
Preheat Time ( $t_{s_{min}}$ to $t_{s_{max}}$ )	60 - 180 seconds
Temperature ( $T_L$ )	217°C
Time Maintained Above Temperature ( $T_L$ )	60 - 150 seconds
Peak / Classification Temperature ( $T_p$ )	260°C
Time Within 5°C of Actual Peak Temperature ( $t_p$ )	20 - 40 seconds
Ramp - Down Rate	6°C / second max
Time 25°C to Peak Temperature	8 minutes max

Notes for Table 6:

- All temperatures refer to the application Printed Circuit Board (PCB), measured on the surface adjacent to the package body.

# Mechanical Dimensions

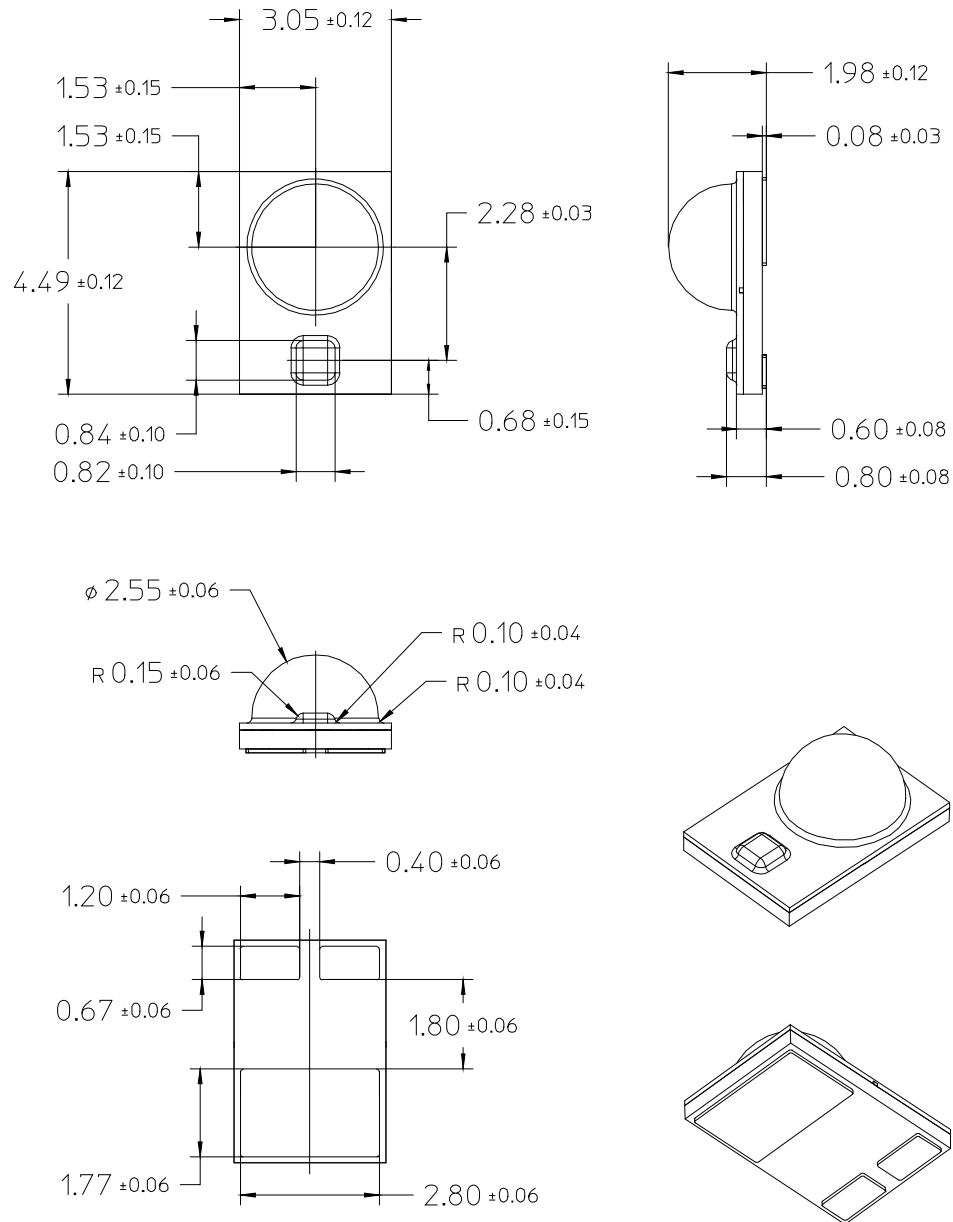

**Figure 1. Package outline drawing.**

Notes for Figure 1:

- Do not handle the device by the lens. Care must be taken to avoid damage to the lens or the interior of the device that can be damaged by excessive force to the lens.
- Drawings not to scale. All dimensions are in millimeters.
- The thermal pad is electrically isolated from the anode and cathode contact pads.

## Pad Configuration

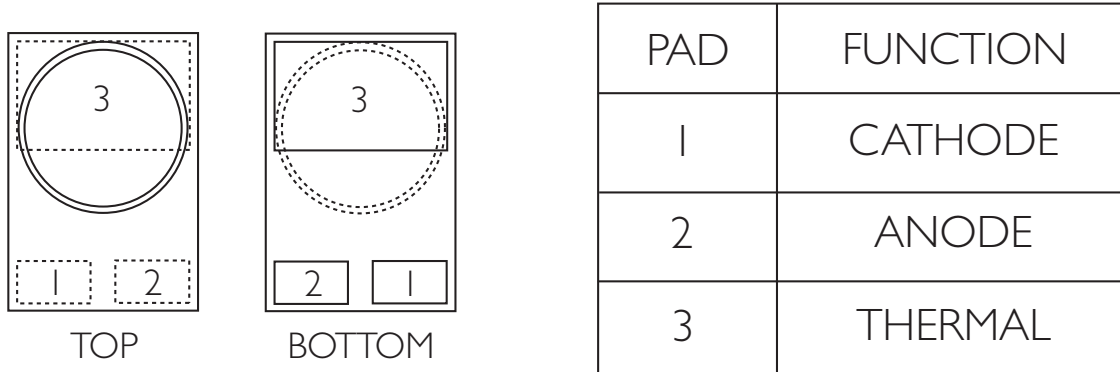

Figure 2. Pad configuration.

Note for Figure 2:

- The Thermal Pad is electrically isolated from the Anode and Cathode contact pads.

## Solder Pad Design

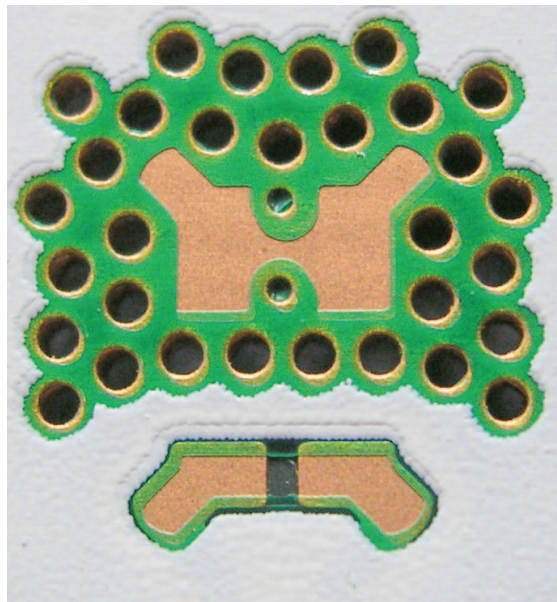

Figure 3. Solder pad layout.

Note for Figure 3:

- The photograph shows the recommended LUXEON A layout on Printed Circuit Board (PCB). This design easily achieves a thermal resistance of 7K/W.
- Application Brief AB32 provides extensive details for this layout. Printed Circuit Board layout files (.dmg) are available at [www.philipslumileds.com](http://www.philipslumileds.com) and [www.philipslumileds.cn.com](http://www.philipslumileds.cn.com).

# Relative Spectral Distribution vs. Wavelength Characteristics

## LXH8-PW27 at Test Current, Junction Temperature = 85°C

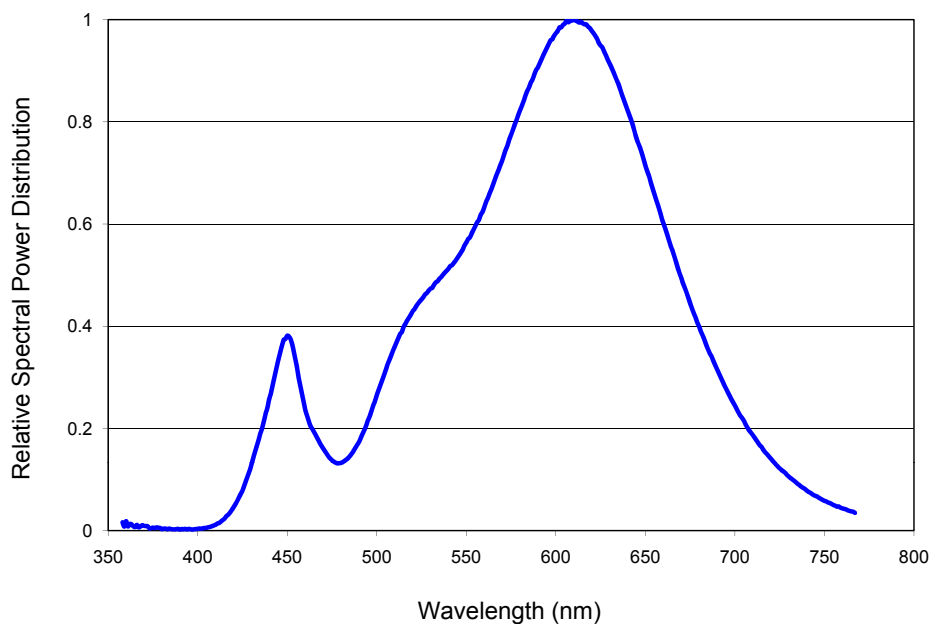

Figure 4. Color spectrum of LXH8-PW27 emitter, integrated measurement.

## LXH8-PW30 at Test Current, Junction Temperature = 85°C

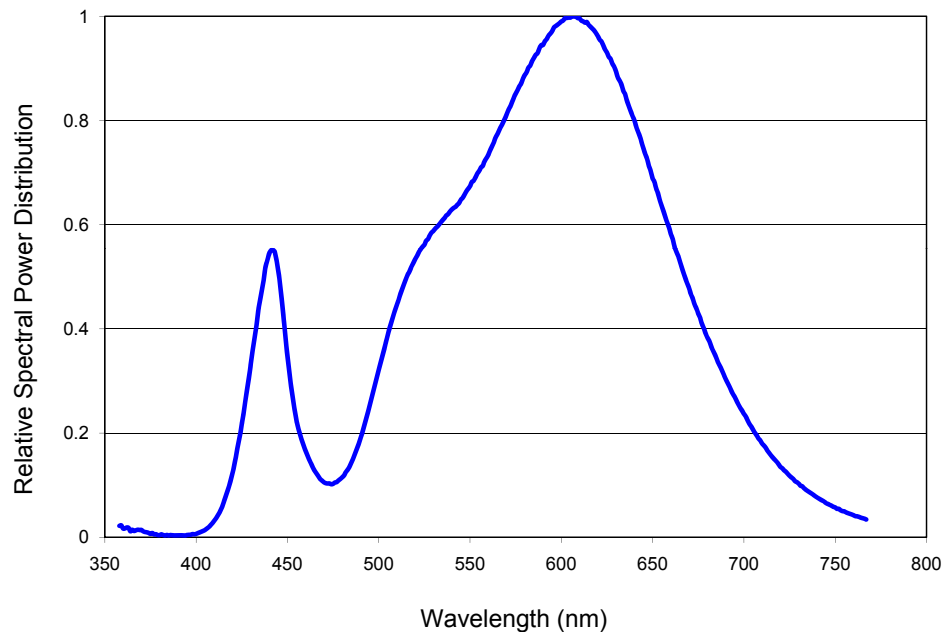

Figure 5. Color spectrum of LXH8-PW30 emitter, integrated measurement.

## LXH9-PW30 at Test Current, Junction Temperature = 85°C

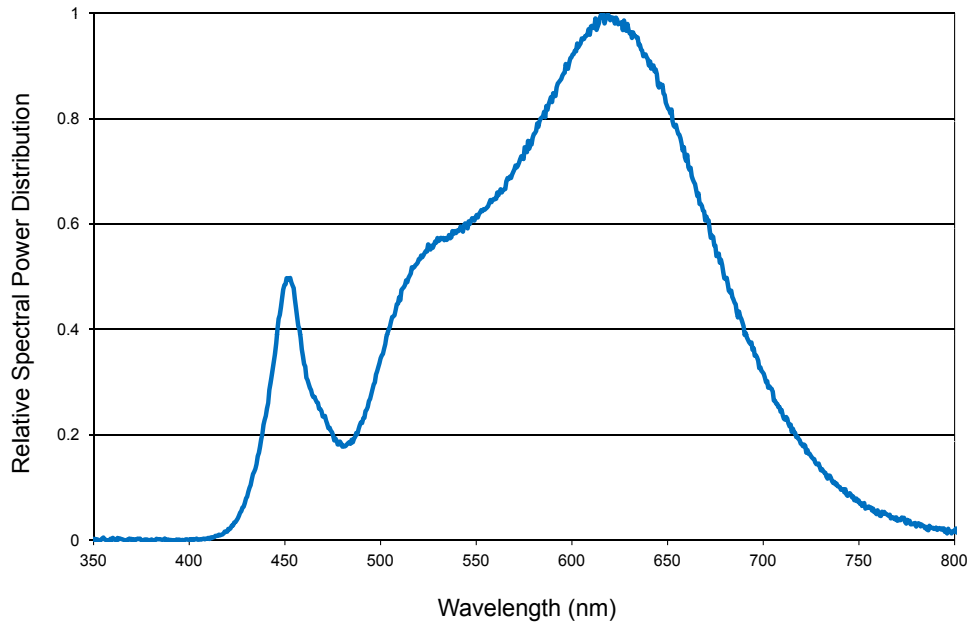

Figure 6. Color spectrum of LXH9-PW30 emitter, integrated measurement.

## LXH8-PW40 at Test Current, Junction Temperature = 85°C

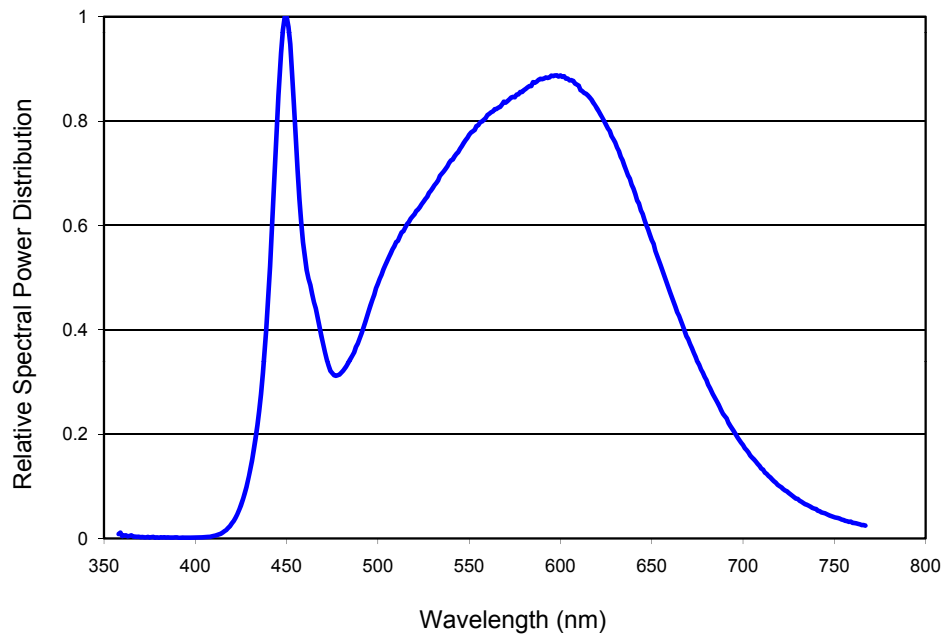

Figure 7. Color spectrum of LXH8-PW40 emitter, integrated measurement.

## LXH8-PW50 at Test Current, Junction Temperature = 85°C

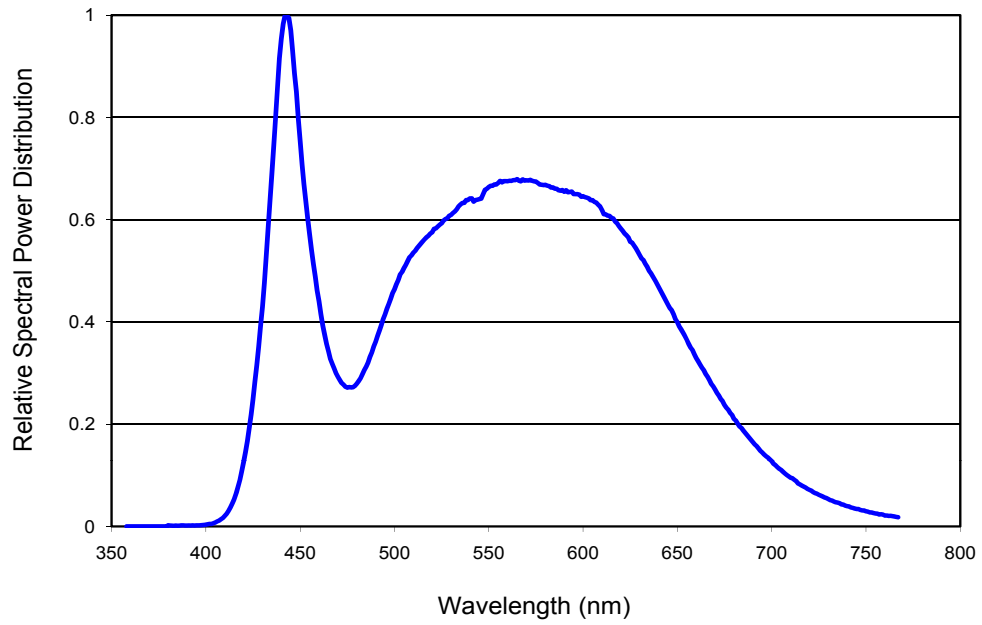

Figure 8. Color spectrum of LXH8-PW50 emitter, integrated measurement.

# Typical Light Output Characteristics over Temperature

## All LUXEON A Emitters at Test Current

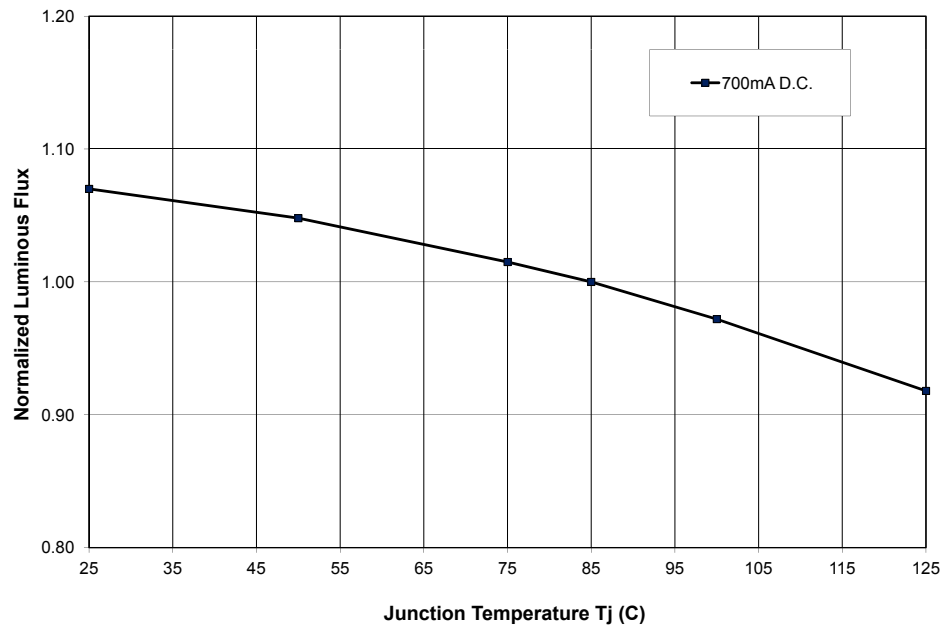

Figure 9. Relative light output vs. junction temperature.

# Typical Forward Current Characteristics

All LUXEON A Emitters, Junction Temperature = 85°C

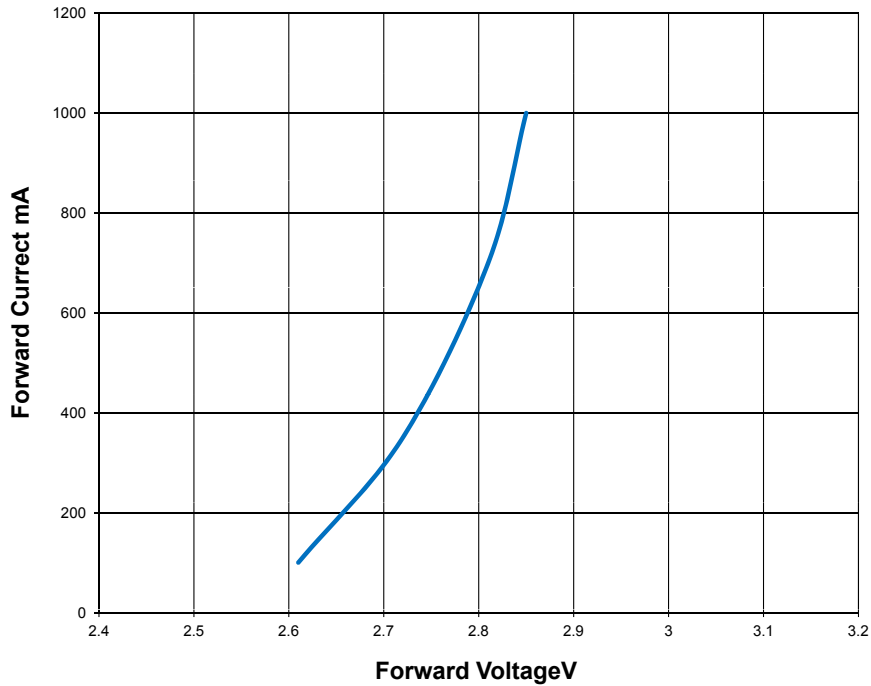

Figure 10. Forward current vs. forward voltage.

Typical Relative Luminous Flux vs. Forward Current for All LUXEON A Emitters, Junction Temperature = 85°C

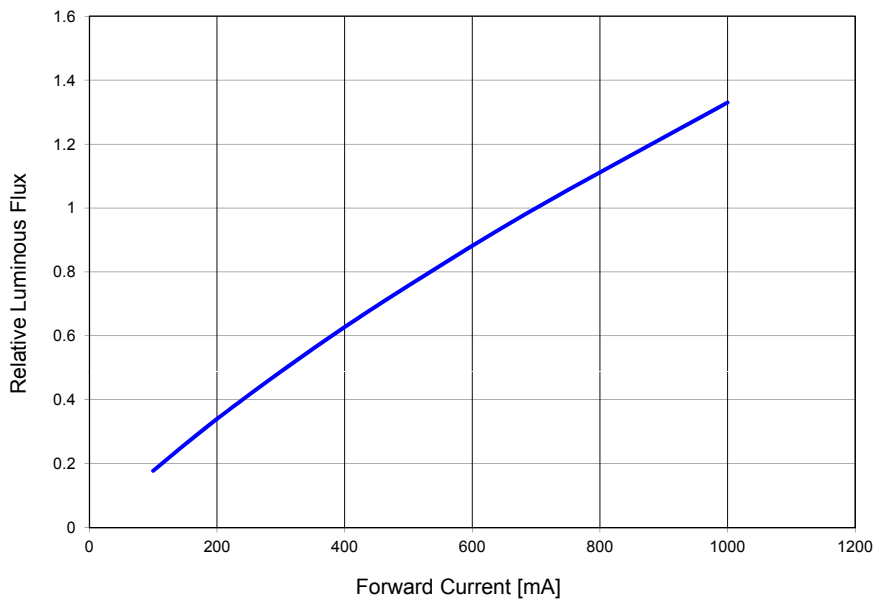

Figure 11. Typical relative luminous flux vs. forward current, junction temperature = 85°C.

# Current Derating Curves

## Current Derating Curve for 350 mA Drive Current All LUXEON A Emitters

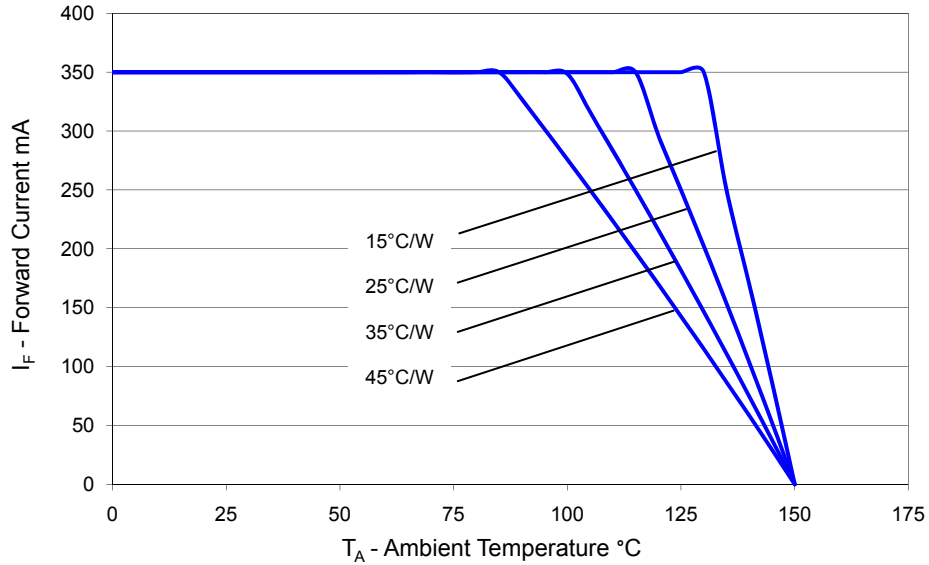

Figure 12. Maximum forward current vs. ambient temperature, based on  $T_{JMAX} = 150^\circ\text{C}$ .

## Current Derating Curve for 700 mA Drive Current All LUXEON A Emitters

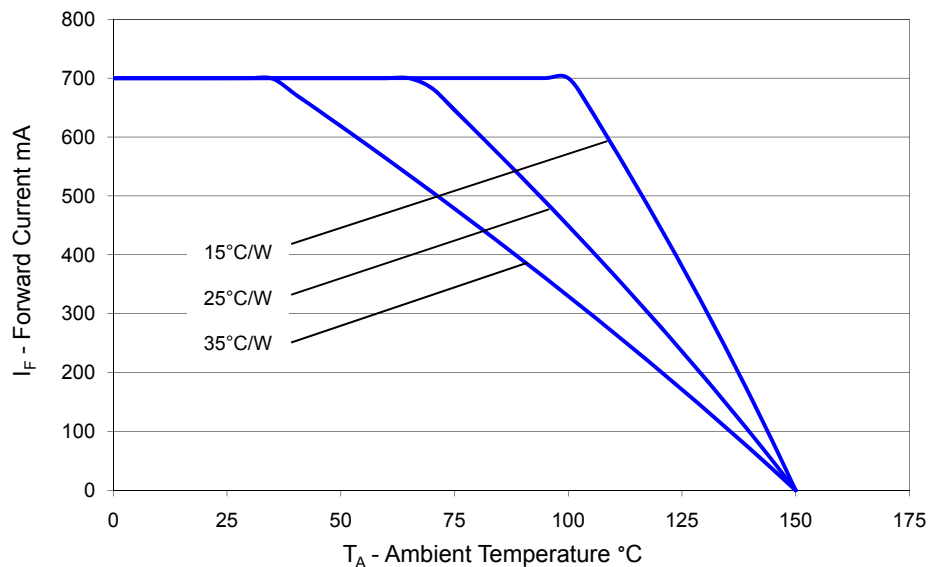

Figure 13. Maximum forward current vs. ambient temperature, based on  $T_{JMAX} = 150^\circ\text{C}$ .

## Current Derating Curve for 1000 mA Drive Current All LUXEON A Emitters

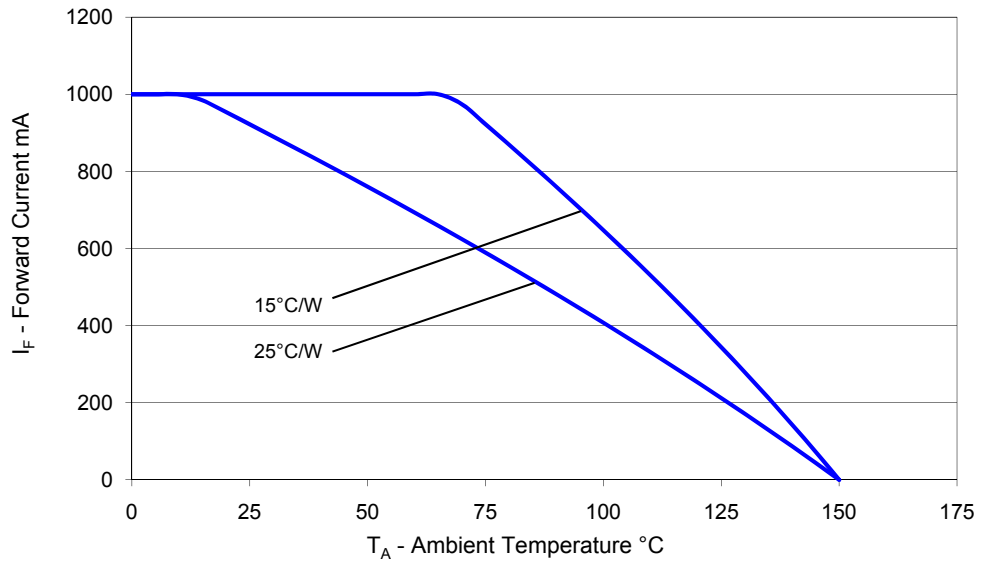

Figure 14. Maximum forward current vs. ambient temperature, based on  $T_{JMAX} = 150^{\circ}\text{C}$ .

# Typical Radiation Patterns

## Typical Luminous Intensity Distribution Pattern for LUXEON A Emitters

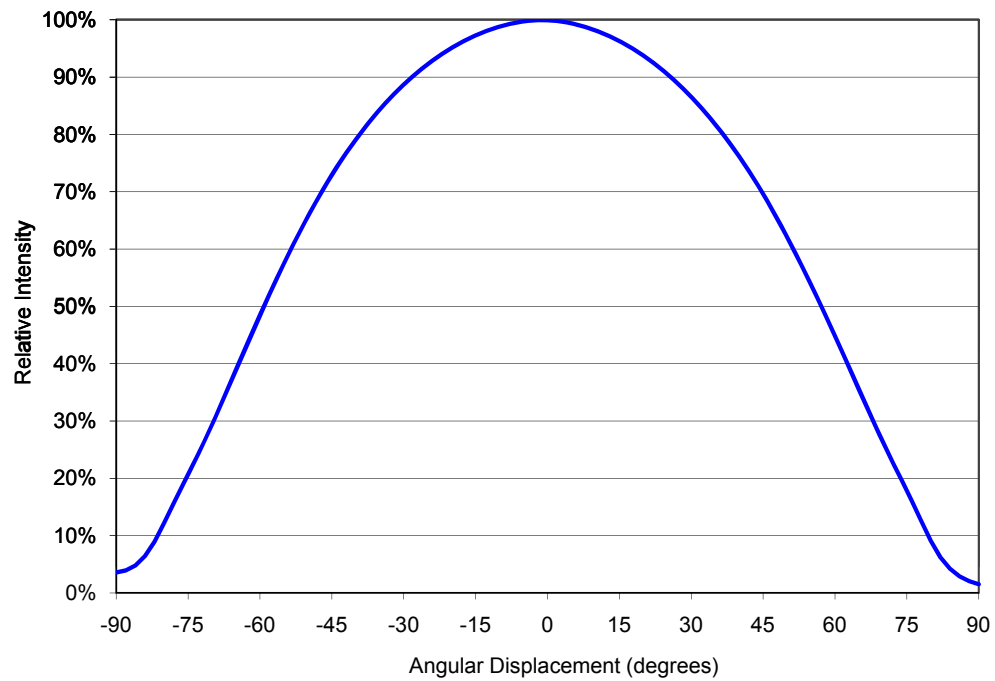

Figure 15. Cartesian plot of typical luminous intensity.

# Typical $du'$ versus $dv'$ Characteristic Versus Angle

## Typical and Maximum $du'$ and $dv'$ Color Variation vs. Viewing Angle for 2700K and 3000K LUXEON A Emitters

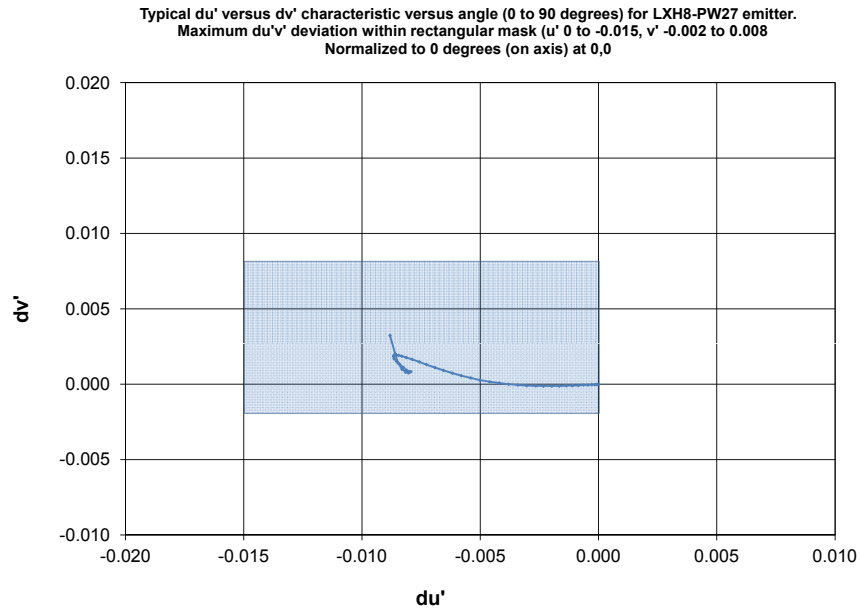

Figure 16.

## Typical and Maximum $du'$ and $dv'$ Color Variation vs. Viewing Angle for 4000K LUXEON A Emitters

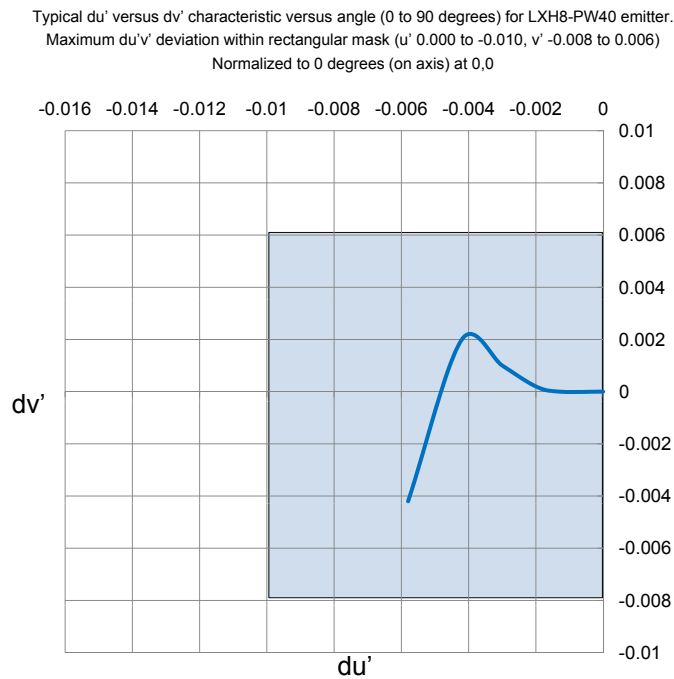
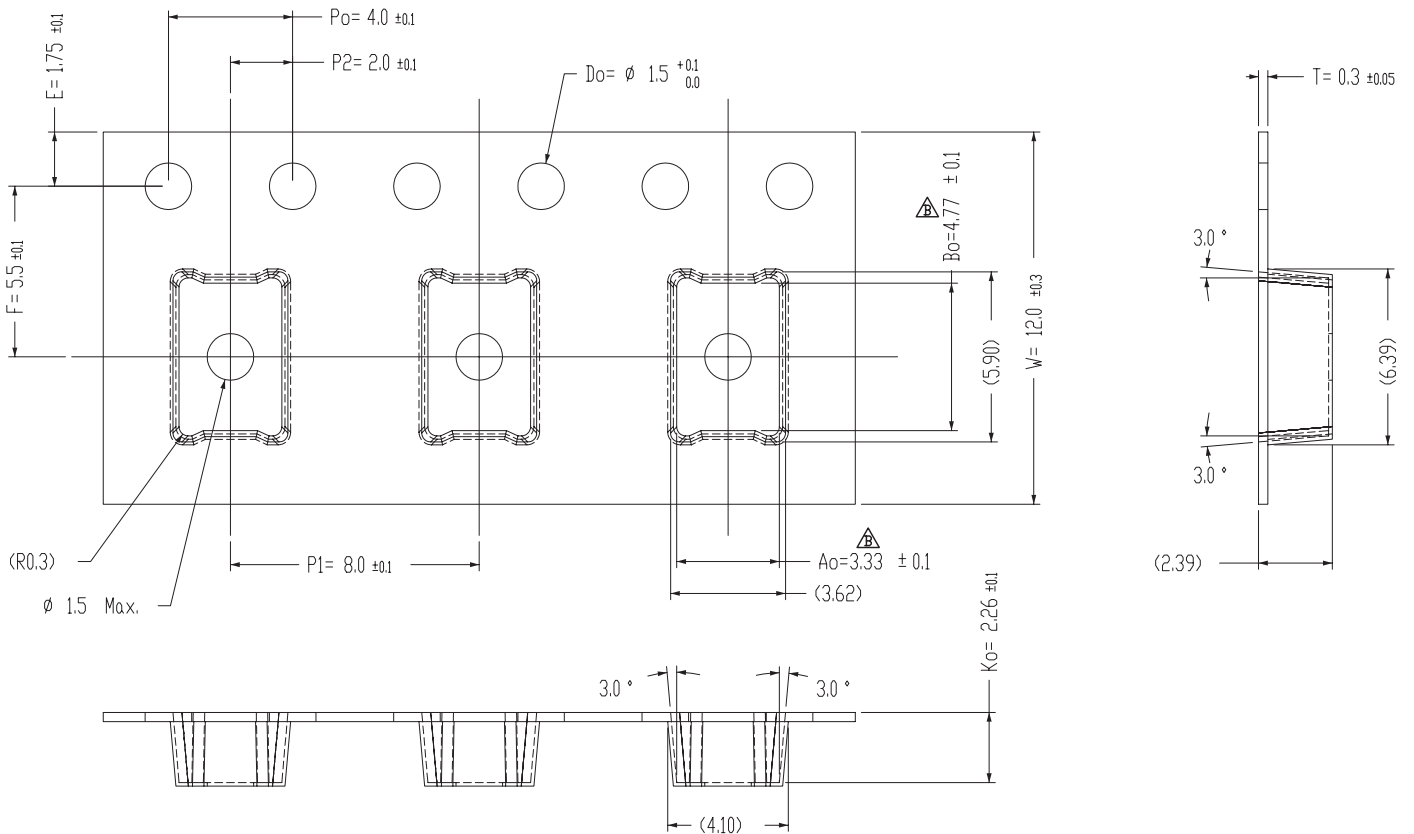
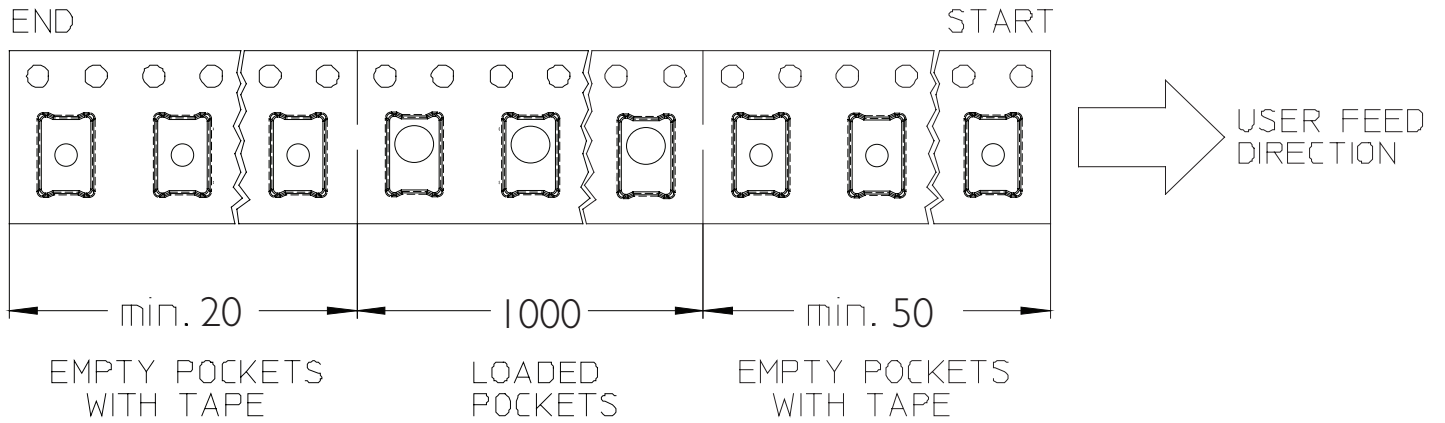
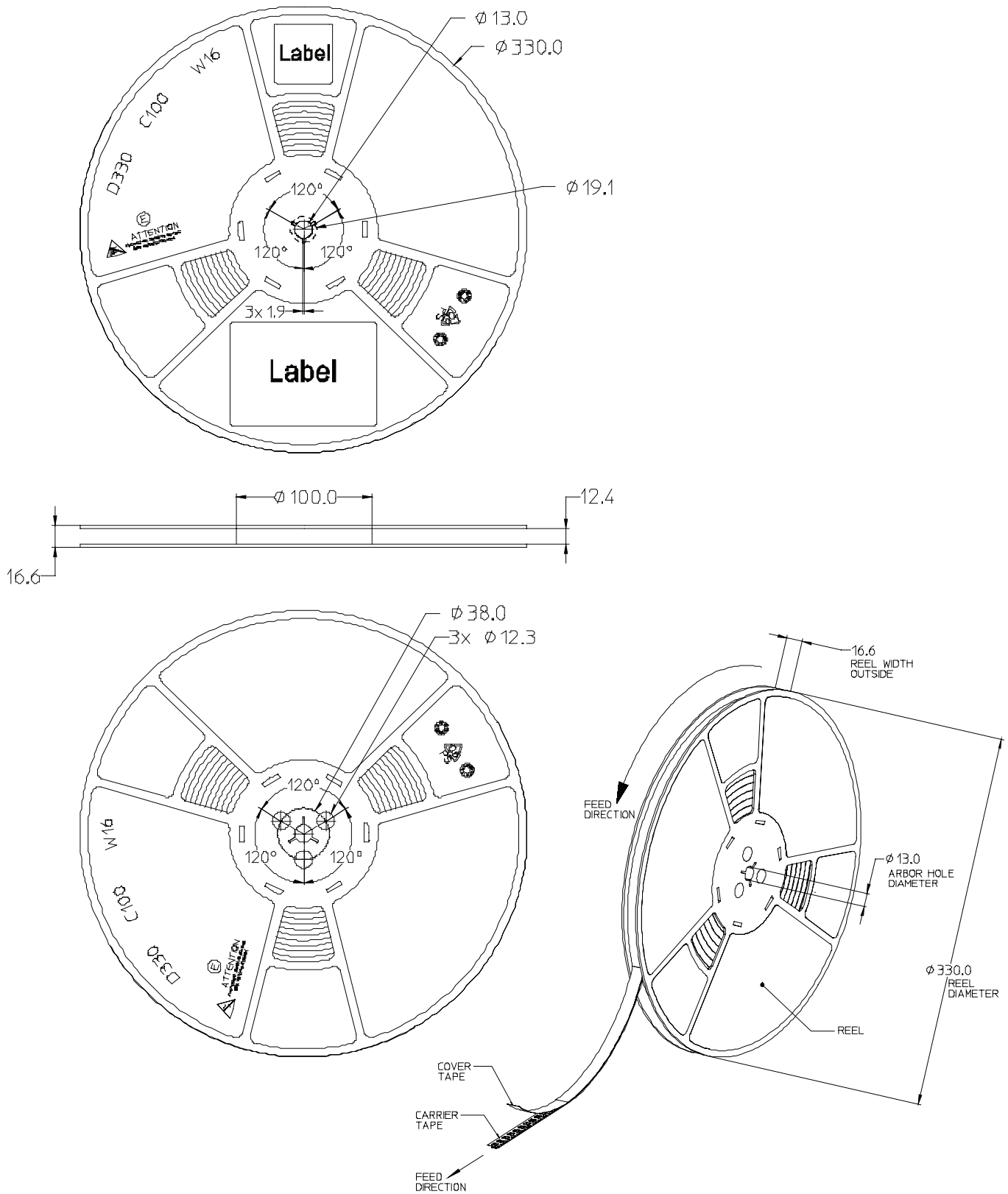

Figure 17.

# Emitter Pocket Tape Packaging



# Emitter Reel Packaging



# Product Binning and Labeling

## **Purpose of Product Binning**

In the manufacturing of semiconductor products, there is a variation of performance around the average values given in the technical data sheets. For this reason, Philips Lumileds bins the LED components for luminous flux and forward voltage ( $V_f$ ). Color is offered in a single 3-step MacAdam ellipse color space centered on the ANSI CCT color bins; 2725K for nominal 2700K, 3045K for nominal 3000K, 3985K for 4000K, and 5028K for 5000K. For additional information please review the MacAdam ellipse technical definition section.

## **Decoding Product Bin Labeling**

LUXEON A emitters are labeled using a two digit alphanumeric code (CAT code) depicting the bin values for emitters packaged on a single reel. All emitters packaged within a reel are of the same 2-variable bin combination. Using these codes, it is possible to determine optimum mixing and matching of products for consistency in a given application.

Reels of LUXEON A emitters are labeled with a two digit alphanumeric CAT code following the format below.

AB

A = Flux bin (P, Q, R, S or 1 through 9, M, N, U, or V)

B =  $V_f$  bin (P, R, S and T)

# Luminous Flux Bins

Table 7 lists the standard photometric luminous flux bins for LUXEON A emitters (tested and binned at 700 mA D.C., Junction Temperature = 85°C. Minimum luminous flux performance within published operating conditions. Philips Lumileds maintains a tolerance of  $\pm 6.5\%$  on luminous flux measurements.

Although several bins are outlined, product availability in a particular bin varies by production run and by product performance. Not all bins are available in all CCT's.

**Table 7.**

Flux Bins		
Bin Code	Minimum Photometric Flux (lm)	Maximum Photometric Flux (lm)
P	120	140
Q	140*	160
R	160	180
S	180	200

\* 150 lm for LXH8-PW30

Beginning in April 2012, LUXEON A will transition to 10 lumen flux bins as shown in the table below. This transition may result in mixed shipments of old bin codes and new bin codes during calendar year 2012.

**Table 8.**

Flux Bins		
Bin Code	Minimum Photometric Flux (lm)	Maximum Photometric Flux (lm)
1	120	130
2	130	140
3	140	150
4	150	160
5	160	170
6	170	180
7	180	190
8	190	200
9	200	210
M	210	220
N	220	230
U	230	240
V	240	255

# LUXEON A 3-step MacAdam Ellipse Color Definition

Tested at 700 mA D.C. & Junction Temperature = 85°C

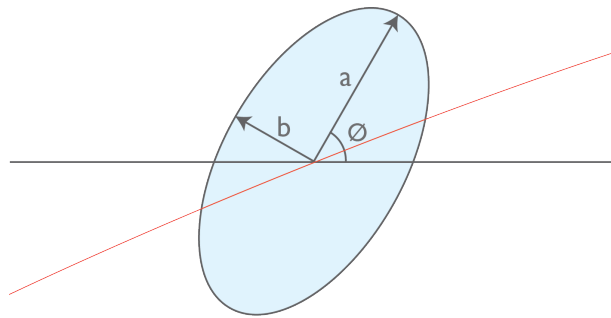

**Table 9. LUXEON A Product Characteristics**

Part Number	Nominal ANSI CCT	Color Space	Center Point (cx, cy)	Major Axis, a	Minor Axis, b	Ellipse Rotation Angle
LXH8-PW27	2700K	Single 3-step MacAdam ellipse	0.4578, 0.4101	0.00810	0.00420	53.70
LXH8-PW30	3000K	Single 3-step MacAdam ellipse	0.4338, 0.4030	0.00834	0.00408	53.22
LXH9-PW30	3000K	Single 3-step MacAdam ellipse	0.4338, 0.4030	0.00834	0.00408	53.22
LXH8-PW40	4000K	Single 3-step MacAdam ellipse	0.3818, 0.3797	0.00939	0.00402	53.72
LXH8-PW50	5000K	Single 3-step MacAdam ellipse	0.3447, 0.3553	0.00822	0.00354	59.62

Note for Table 9:

- Philips Lumileds maintains a tester tolerance of  $\pm 0.005$  on x, y color coordinates.

# Forward Voltage Bins

Table 10 lists minimum and maximum  $V_f$  bin values per emitter (tested and binned at 700 mA). Although several bins are outlined, product availability in a particular bin varies by production run and by product performance.

**Table 10.**

$V_f$  Bins

Bin Code	Minimum Forward Voltage (V)	Maximum Forward Voltage (V)
P	2.50	2.75
R	2.75	3.00
S	3.00	3.25
T	3.25	3.50

Note for Table 10:

- Philips Lumileds maintains a tolerance of  $\pm 0.06V$  on forward voltage measurements.

# Company Information

Philips Lumileds is a leading provider of LEDs for everyday lighting applications. The company's records for light output, efficacy and thermal management are direct results of the ongoing commitment to advancing solid-state lighting technology and enabling lighting solutions that are more environmentally friendly, help reduce CO<sub>2</sub> emissions and reduce the need for power plant expansion. Philips Lumileds LUXEON® LEDs are enabling never before possible applications in outdoor lighting, shop lighting, home lighting, consumer electronics, and automotive lighting.

Philips Lumileds is a fully integrated supplier, producing core LED material in all three base colors, (Red, Green, Blue) and white. Philips Lumileds has R&D centers in San Jose, California and in the Netherlands, and production capabilities in San Jose, Singapore and Penang, Malaysia. Founded in 1999, Philips Lumileds is the high flux LED technology leader and is dedicated to bridging the gap between solid-state technology and the lighting world. More information about the company's LUXEON LED products and solid-state lighting technologies can be found at [www.philipslumileds.com](http://www.philipslumileds.com).

©2012 Philips Lumileds Lighting Company. All rights reserved.  
Product specifications are subject to change without notice.

**PHILIPS**  
**LUMILEDS**

[www.philipslumileds.com](http://www.philipslumileds.com)  
[www.philipslumileds.cn.com](http://www.philipslumileds.cn.com)

## Looking for pricing, stock, or lifecycle information?

Click below to explore more details on WIN SOURCE:

 [View LXH8-PW50 on WIN SOURCE](#)

 [Lumileds Information](#)

## Optimize Your Supply Chain with WIN SOURCE Solutions

-  Global Sourcing Solution
-  Obsolete Management
-  Cost Control Management
-  Shortage Management
-  Alternative Solution
-  Excess Inventory Management