



**THE DATASHEET OF  
RT8071CGQW**



## 3A, 1MHz, Synchronous Step-Down Converter

### *Purpose*

The RT8071C is a high efficiency synchronous, step-down DC/DC converter. Its input voltage ranges from 2.7V to 5.5V that provides an adjustable regulated output voltage from 0.6V to  $V_{IN}$  while delivering up to 3A of output current. This document explains the function and use of the RT8071C evaluation board (EVB), and provides information to enable operation, modification of the evaluation board and circuit to suit individual requirements.

## Table of Contents

Purpose.....	1
Introduction.....	2
Key Performance Summary Table.....	2
Bench Test Setup Conditions.....	3
Schematic, Bill of Materials & Board Layout.....	5
More Information.....	7
Important Notice for Richtek Evaluation Board.....	7

## Introduction

### General Product Information

The RT8071C is a high efficiency synchronous, step-down DC/DC converter. Its input voltage ranges from 2.7V to 5.5V that provides an adjustable regulated output voltage from 0.6V to  $V_{IN}$  while delivering up to 3A of output current. The internal synchronous low On-resistance power switches increase efficiency and eliminate the need for an external Schottky diode. The switching frequency is fixed internally at 1MHz. The 100% duty cycle provides low dropout operation, hence extending battery life in portable systems. Current mode operation with internal compensation allows the transient response to be optimized over a wide range of loads and output capacitors. The RT8071C is available in a WDFN-10L 3x3 package.

### Product Feature

- High Efficiency : Up to 95%
- Low  $R_{DS(ON)}$  Power Switches : 69m $\Omega$ /49m $\Omega$
- Current Mode Operation
- Fast Transient Response
- Fixed Frequency : 1MHz
- No Schottky Diode Required
- Internal Compensation
- 0.6V Reference Allows Low Output Voltage
- Low Dropout Operation : 100% Duty Cycle
- OCP, UVP, OTP
- OpenVReg Type 0-LV Compliant

### Key Performance Summary Table

Key Features	Evaluation Board Number : PCB052_V1
Input Voltage Range	2.7V to 5.5V
Max Output Current	3A
Default Output Voltage	1.05V
Default Marking & Package Type	RT8071CGQW, WDFN-10L 3x3
Operation Frequency	Steady 1MHz at all loads

## Bench Test Setup Conditions

### Headers Description and Placement

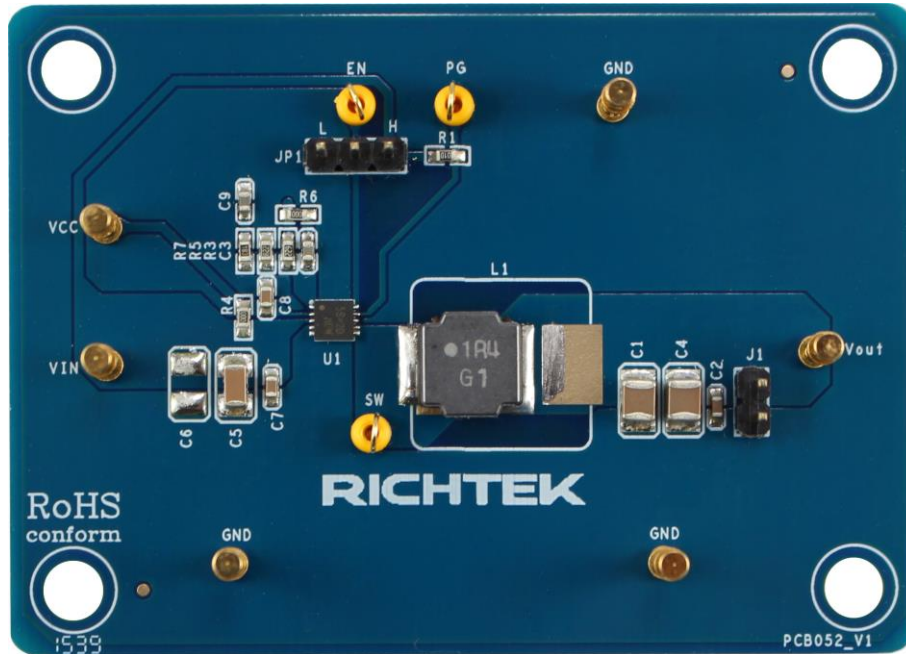

Please carefully inspect the EVB IC and external components, comparing them to the following Bill of Materials, to ensure that all components are installed and undamaged. If any components are missing or damaged during transportation, please contact the distributor or send e-mail to [evb\\_service@richtek.com](mailto:evb_service@richtek.com)

### Test Points

The EVB is provided with the test points and pin names listed in the table below.

Test point/ Pin name	Signal	Comment (expected waveforms or voltage levels on test points)
<b>FB</b>	Feedback voltage input	Feedback Input. This pin receives the feedback voltage from a resistive voltage divider connected across the output.
<b>VCC</b>	Supply voltage input.	Supply Voltage Input. Decouple this pin to GND with at least 1 $\mu$ F ceramic capacitor.
<b>VIN</b>	Input voltage	Power input. Support 2.7V to 5.5V Input Voltage. Decouple this pin to GND with at least 10 $\mu$ F ceramic capacitor.
<b>GND</b>	Ground	Ground. The exposed pad must be soldered to a large PCB and connected to GND for maximum power dissipation.
<b>SW</b>	Switch node test point	Switch Node. Connect this pin to the inductor.
<b>NC</b>	No connection	No Internal Connection.
<b>PGOOD</b>	Power good indicator	Power Good Indicator. This pin is an open drain logic output. The PGOOD will be pulled to ground when the output voltage is less than 90% of the target output voltage.
<b>EN</b>	Enable test point	Enable Control Input. Pull high the EN pin to turn on the converter.

**Power-up & Measurement Procedure**

1. Connect input power ( $2.7V < V_{IN} < 5.5V$ ) and input ground to VIN and GND test pins respectively.
2. Connect positive end and negative terminals of load to VOUT and GND test pins respectively.
3. There is a 3-pin header "EN" for enable control. To use a jumper at "H" option to tie EN test pin to input power VIN for enabling the device. Inversely, to use a jumper at "L" option to tie EN test pin and ground GND for disabling the device.
4. Verify the output voltage (approximately 1.05V) between VOUT and GND.
5. Connect an external load up to 3A to the VOUT and GND terminals and verify the output voltage and current.

**Output Voltage Setting**

Set the output voltage with the resistive divider (R3, R5) between VOUT and GND with the midpoint connected to FB. The output is set by the following formula :

$$V_{OUT} = V_{FB} \times \left(1 + \frac{R3}{R5}\right)$$

**Schematic, Bill of Materials & Board Layout**

**EVB Schematic Diagram**

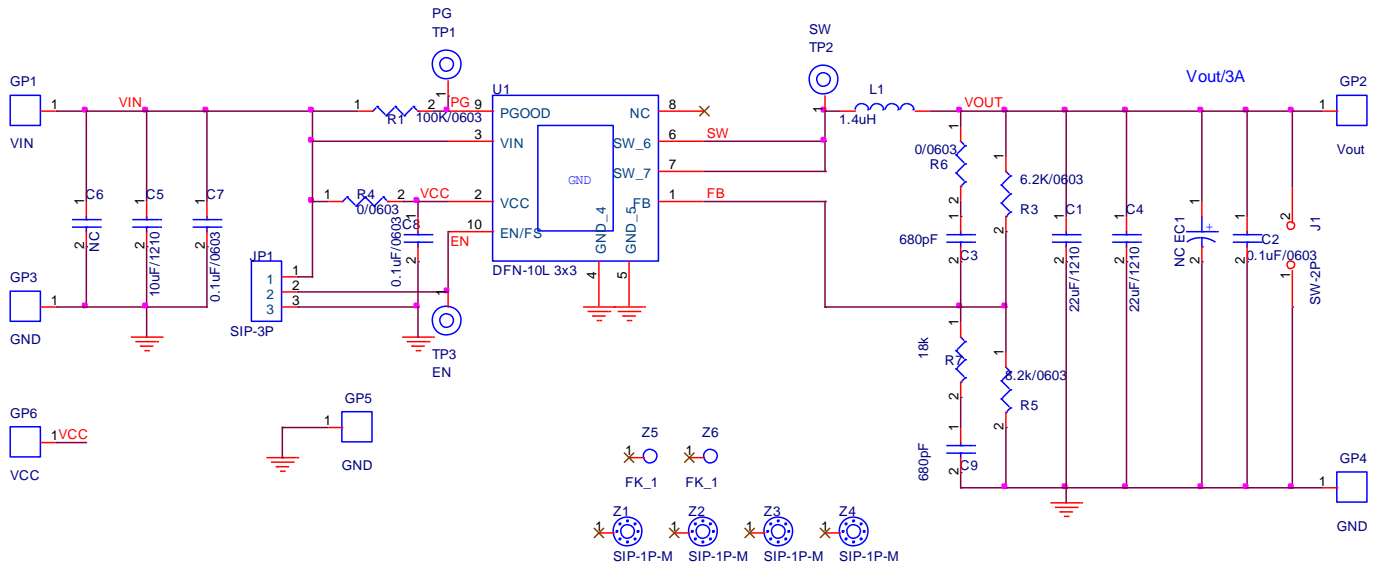

**Bill of Materials**

Reference	Qty	Part Number	Description	Package	Manufacture
U1	1	RT8071CGQW	DC/DC Converter	WDFN-10L 3x3	RICHTEK
C1, C4	2	C3225X5R0J226M	22μF/25V//X5R	1210	TDK
C5	1	C3225X5R0J106M	10μF/50V//X5R	1210	TDK
C6	1		NC	1210	TDK
C3, C9	1	0603B681K500NT	680pF/50V//X7R	0603	WALSIN
C2, C7, C8	3	0603B104K500NT	0.1μF/50V//X7R	0603	WALSIN
EC1	1		NC	1206	JACKSON
L1	1	NR8040T1R4N	1.4μH		TAIYO
R1	1	WR06X1003FT	100k	0603	WALSIN
R3	1	WR06X6201FT	6.2k	0603	WALSIN
R5	1	WR06X8201FT	8.2k	0603	WALSIN
R4, R6	2	WR06X000PT	0	0603	WALSIN
R7	1	WR06X1802FT	18k	0603	WALSIN

**PCB Layout**

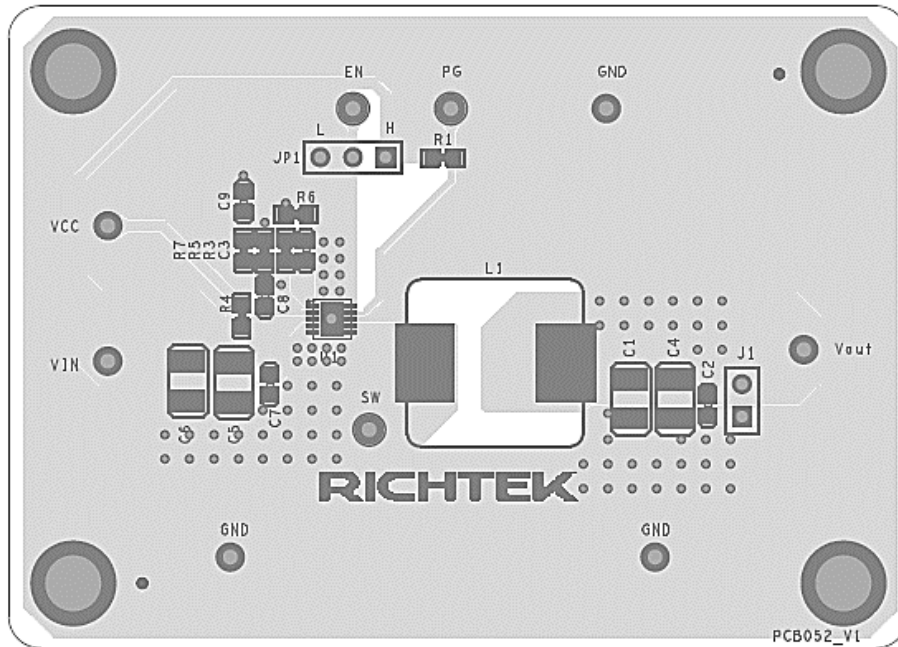

Top View

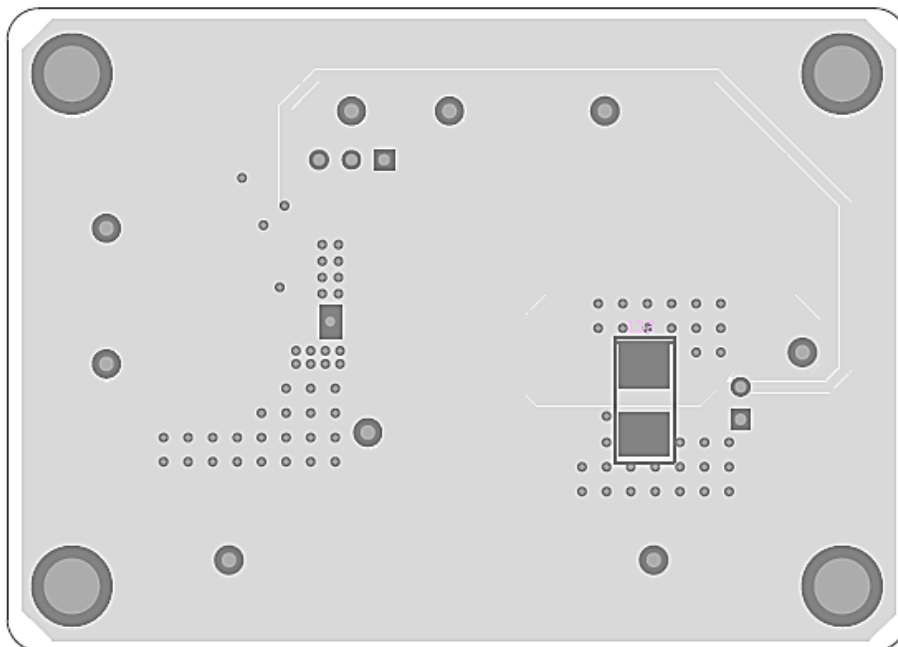

Bottom View

### ***More Information***

For more information, please find the related datasheet or application notes from Richtek website <http://www.richtek.com>.

### ***Important Notice for Richtek Evaluation Board***

THIS DOCUMENT IS FOR REFERENCE ONLY, NOTHING CONTAINED IN THIS DOCUMENT SHALL BE CONSTRUED AS RICHTEK'S WARRANTY, EXPRESS OR IMPLIED, UNDER CONTRACT, TORT OR STATUTORY, WITH RESPECT TO THE PRESENTATION HEREIN. IN NO EVENT SHALL RICHTEK BE LIABLE TO BUYER OR USER FOR ANY AND ALL DAMAGES INCLUDING WITHOUT LIMITATION TO DIRECT, INDIRECT, SPECIAL, PUNITIVE OR CONSEQUENTIAL DAMAGES.







## Looking for pricing, stock, or lifecycle information?

Click below to explore more details on WIN SOURCE:

 [View RT8071CGQW on WIN SOURCE](#)

 [Richtek USA Inc. Information](#)

## Optimize Your Supply Chain with WIN SOURCE Solutions

-  Global Sourcing Solution
-  Obsolete Management
-  Cost Control Management
-  Shortage Management
-  Alternative Solution
-  Excess Inventory Management