



THE DATASHEET OF BAR46AFILM





BAR46 BAR46AFILM

SMALL SIGNAL SCHOTTKY DIODES

FEATURES AND BENEFITS

- VERY SMALL CONDUCTION LOSSES
- NEGLIGIBLE SWITCHING LOSSES
- LOW FORWARD VOLTAGE DROP
- SURFACE MOUNT DEVICE

DESCRIPTION

High voltage Schottky rectifier suited for SLIC protection during the card insertion operation.

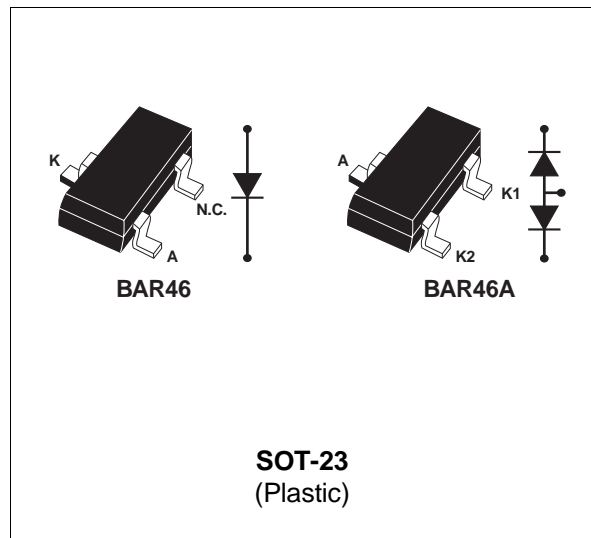

ABSOLUTE RATINGS (limiting values)

Symbol	Parameter		Value	Unit
V_{RRM}	Repetitive peak reverse voltage		100	V
I_F	Continuous forward current		150	mA
P_{tot}	Power dissipation (note 1)	$T_{amb} = 25^\circ\text{C}$	230	mW
T_{stg}	Maximum storage temperature range		- 65 to +150	$^\circ\text{C}$
T_j	Maximum operating junction temperature *		150	$^\circ\text{C}$
T_L	Maximum temperature for soldering during 10s		260	$^\circ\text{C}$

Note 1: for double diodes, P_{tot} is the total dissipation of both diodes.

* : $\frac{dP_{tot}}{dT_j} < \frac{1}{R_{th(j-a)}}$ thermal runaway condition for a diode on its own heatsink

THERMAL RESISTANCE

Symbol	Parameter	Value	Unit
$R_{th(j-a)}$	Junction-ambient *	500	$^\circ\text{C}/\text{W}$

* Mounted on epoxy board, with recommended pad layout.

BAR46 /BAR46AFILM

ELECTRICAL CHARACTERISTICS

STATIC CHARACTERISTICS

Symbol	Test conditions		Min.	Typ.	Max.	Unit
V_{BR}	$T_j = 25\text{ °C}$	$I_R = 100\text{ }\mu\text{A}$	100			V
V_F^*	$T_j = 25\text{ °C}$	$I_F = 0.1\text{ mA}$			0.25	V
	$T_j = 25\text{ °C}$	$I_F = 10\text{ mA}$			0.45	
	$T_j = 25\text{ °C}$	$I_F = 250\text{ mA}$			1	
I_R^{**}	$T_j = 25\text{ °C}$	$V_R = 1.5\text{ V}$			0.5	μA
	$T_j = 60\text{ °C}$				5	
	$T_j = 25\text{ °C}$	$V_R = 10\text{ V}$			0.8	
	$T_j = 60\text{ °C}$				7.5	
	$T_j = 25\text{ °C}$	$V_R = 50\text{ V}$			2	
	$T_j = 60\text{ °C}$				15	
	$T_j = 25\text{ °C}$	$V_R = 75\text{ V}$			5	
	$T_j = 60\text{ °C}$				20	

Pulse test : * $t_p = 380\mu\text{s}$ $\delta < 2\%$

** $t_p = 5\text{ ms}$, $\delta < 2\%$

DYNAMIC CHARACTERISTICS

Symbol	Test conditions		Min.	Typ.	Max.	Unit
C	$T_j = 25\text{ °C}$	$V_R = 0\text{ V}$		10		pF
	$T_j = 25\text{ °C}$	$V_R = 1\text{ V}$		6		

Fig. 1: Forward current versus forward voltage at different temperatures (typical values).

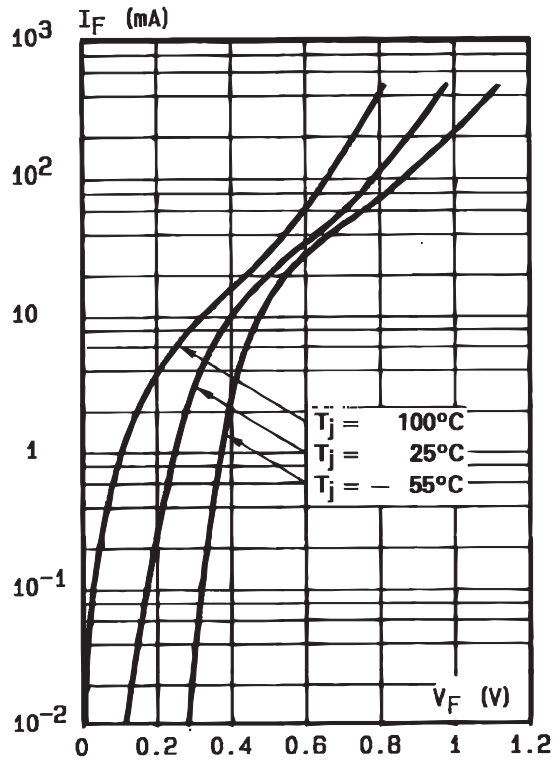

Fig. 2: Forward current versus forward voltage (typical values).

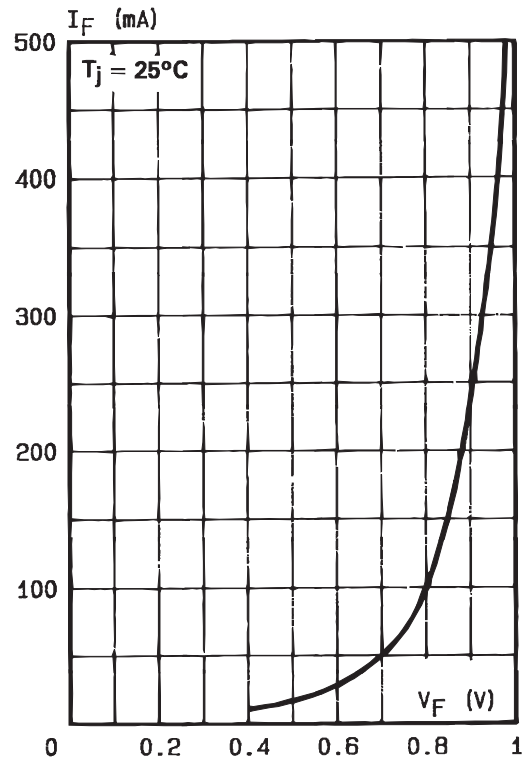

Fig. 3: Reverse current versus junction temperature (typical values).

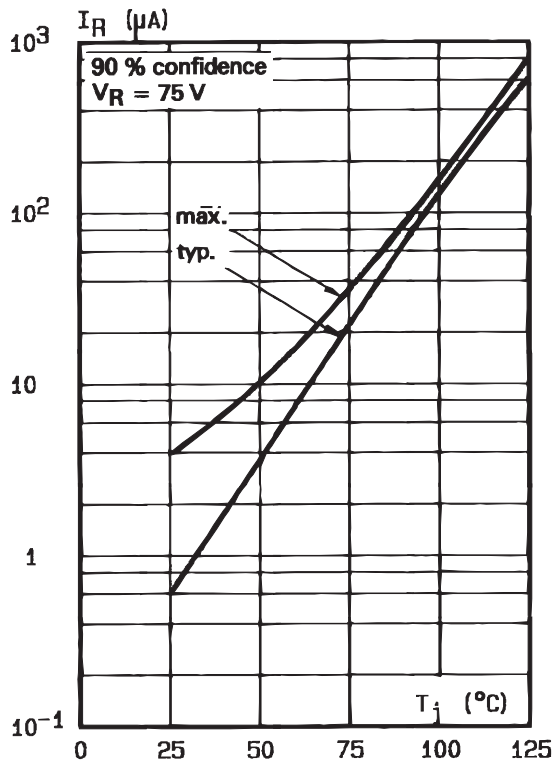
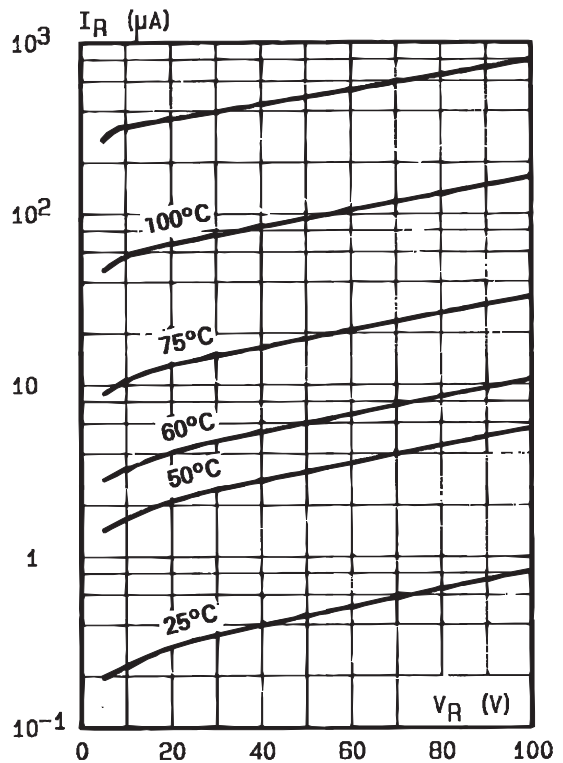
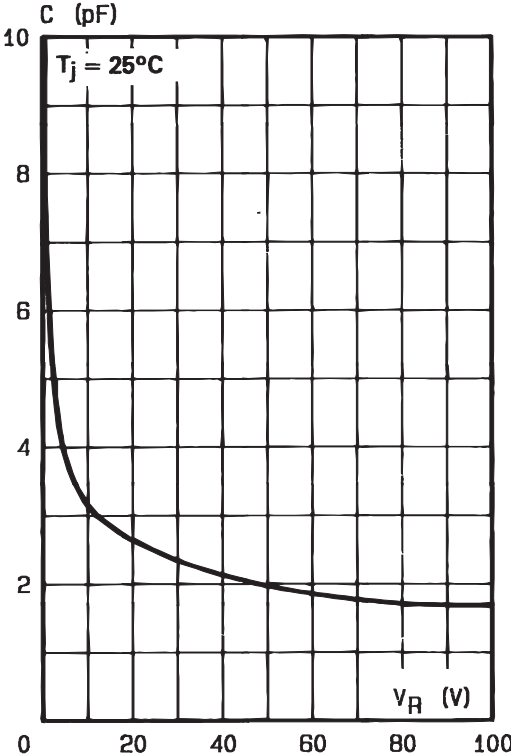

Fig. 4: Reverse current versus continuous reverse voltage (typical values).



BAR46 /BAR46AFILM

Fig. 5: Capacitance C versus reverse applied voltage V_R (typical values).



PACKAGE MECHANICAL DATA

SOT-23 (Plastic)

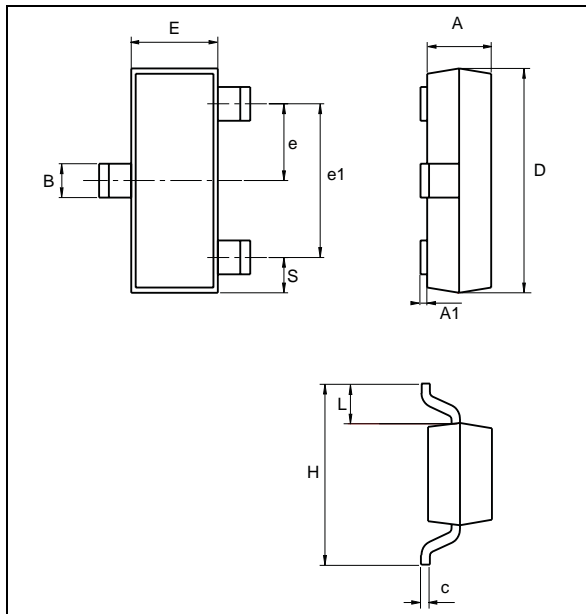

REF.	DIMENSIONS			
	Millimeters		Inches	
	Min.	Max.	Min.	Max.
A	0.89	1.4	0.035	0.055
A1	0	0.1	0	0.004
B	0.3	0.51	0.012	0.02
c	0.085	0.18	0.003	0.007
D	2.75	3.04	0.108	0.12
e	0.85	1.05	0.033	0.041
e1	1.7	2.1	0.067	0.083
E	1.2	1.6	0.047	0.063
H	2.1	2.75	0.083	0.108
L	0.6 typ.		0.024 typ.	
S	0.35	0.65	0.014	0.026

FOOT PRINT DIMENSIONS (Millimeter)

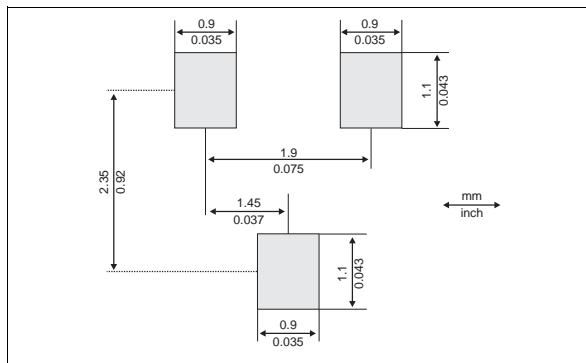

Ordering type	Marking	Package	Weight	Base qty	Delivery mode
BAR46	S46	SOT-23	0.01g	3000	Tape & reel
BAR46AFILM	A46	SOT-23	0.01g	3000	Tape & reel

■ Epoxy meets UL94,V0

Information furnished is believed to be accurate and reliable. However, STMicroelectronics assumes no responsibility for the consequences of use of such information nor for any infringement of patents or other rights of third parties which may result from its use. No license is granted by implication or otherwise under any patent or patent rights of STMicroelectronics. Specifications mentioned in this publication are subject to change without notice. This publication supersedes and replaces all information previously supplied. STMicroelectronics products are not authorized for use as critical components in life support devices or systems without express written approval of STMicroelectronics.

The ST logo is a registered trademark of STMicroelectronics

© 2002 STMicroelectronics - Printed in Italy - All rights reserved.

STMicroelectronics GROUP OF COMPANIES

Australia - Brazil - Canada - China - Finland - France - Germany
 Hong Kong - India - Israel - Italy - Japan - Malaysia - Malta - Morocco - Singapore
 Spain - Sweden - Switzerland - United Kingdom - United States.

<http://www.st.com>



Looking for pricing, stock, or lifecycle information?

Click below to explore more details on WIN SOURCE:

- ⊖ [View BAR46AFILM](#) on WIN SOURCE
- ⊖ [STMicroelectronics](#) Information

Optimize Your Supply Chain with WIN SOURCE Solutions

- ✓ Global Sourcing Solution
- ✓ Obsolete Management
- ✓ Cost Control Management
- ✓ Shortage Management
- ✓ Alternative Solution
- ✓ Excess Inventory Management