

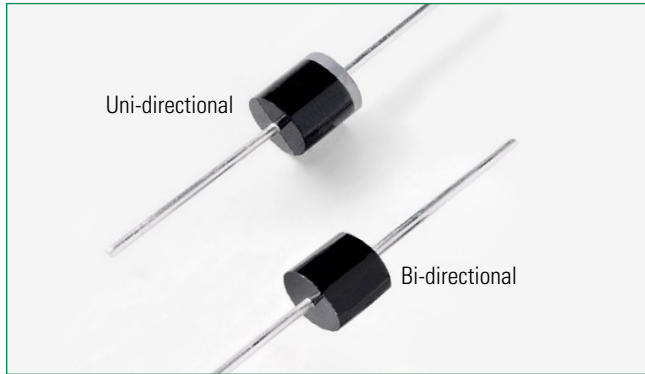

**THE DATASHEET OF
15KPA36CA**



15KPA Series



Agency Approvals	
Agency	Agency File Number
	E230531

Maximum Ratings and Thermal Characteristics
(T_A = 25°C unless otherwise noted)

Parameter	Symbol	Value	Unit
Peak Pulse Power Dissipation by 10/1000µs Test Waveform (Fig.2)(Note 1)	P _{PPM}	15	kW
Steady State Power Dissipation on Infinite Heat Sink at T _L = 75°C	P _D	8.0	W
Peak Forward Surge Current, 8.3ms Single Half Sine Wave Unidirectional Only (Note 2)	I _{FSM}	400	A
Operating Junction and Storage Temperature Range	T _J , T _{STG}	-55 to 175	°C
Typical Thermal Resistance Junction to Lead	R _{θJL}	8.0	°C/W
Typical Thermal Resistance Junction to Ambient	R _{θJA}	40	°C/W

Notes:
 1. Non-repetitive current pulse, per Fig. 4 and derated above T_J (initial) = 25°C per Fig. 3.
 2. Measured on 8.3ms single half sine wave or equivalent square wave, duty cycle=4 per minute maximum.

Functional Diagram

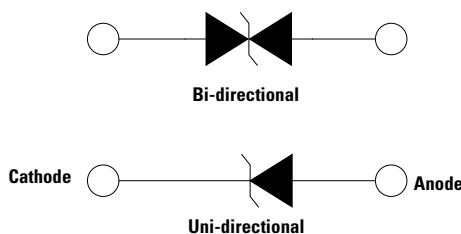

Descriptions

The 15KPA Series is designed specifically to protect sensitive electronic equipment from voltage transients induced by lightning and other transient voltage events.

Features

- Glass passivated chip junction in P600 package
- 15kW peak pulse capability at 10/1000µs waveform, repetition rate (duty cycles):0.01 %
- Fast response time: typically less than 1.0ps from 0 Volts to BV min
- Excellent clamping capability
- Typical failure mode is short from over-specified voltage or current
- Whisker test is conducted based on JEDEC JESD201A per its table 4a and 4c
- IEC 61000-4-2 ESD 30kV(Air), 30kV (Contact)
- ESD protection of data lines in accordance with IEC 61000-4-2
- EFT protection of data lines in accordance with IEC 61000-4-4
- Low incremental surge resistance
- Typical I_R less than 2µA when V_{BR} min>36V
- High temperature to reflow soldering guaranteed: 260°C/40sec / 0.375", (9.5mm) lead length, 5 lbs., (2.3kg) tension
- V_{BR} @ T_J = V_{BR} @ 25°C x (1 + α T x (T_J - 25)) (α T: Temperature Coefficient, typical value is 0.1%)
- UL Recognized compound meeting flammability rating V-0
- Matte tin lead-free plated
- Halogen free and RoHS compliant
- Pb-free E3 means 2nd level interconnect is Pb-free and the terminal finish material is tin(Sn) (IPC/ JEDEC J-STD-609A.01)
- Recognized to UL 497B

Applications

TVS components are ideal for the protection of I/O interfaces, V_{CC} bus and other vulnerable circuits used in telecom, computer, industrial and consumer electronic applications.

Additional Information



[Datasheet](#)



[Resources](#)



[Samples](#)

Electrical Characteristics (T_A=25°C unless otherwise noted)

Part Number (Uni)	Part Number (Bi)	Reverse Stand off Voltage V _R (Volts)	Breakdown Voltage V _{BR} (Volts) @ I _T		Test Current I _T (mA)	Maximum Peak Pulse Current I _{PP} (A)	Maximum Reverse Leakage I _R @ V _R (μA)	Maximum Clamping Voltage V _C @ I _{PP} (V)	Agency Recognition 
			MIN	MAX					
15KPA17A	15KPA17CA	17	18.99	20.79	50	515.4	5000	29.3	X
15KPA18A	15KPA18CA	18	20.11	22.01	50	488.7	5000	30.9	X
15KPA20A	15KPA20CA	20	22.34	24.46	20	440.2	1500	34.3	X
15KPA22A	15KPA22CA	22	24.57	26.91	10	407.0	500	37.1	X
15KPA24A	15KPA24CA	24	26.81	29.35	5	371.0	150	40.7	X
15KPA26A	15KPA26CA	26	29.04	31.80	5	343.2	50	44.0	X
15KPA28A	15KPA28CA	28	31.28	34.24	5	317.9	25	47.5	X
15KPA30A	15KPA30CA	30	33.51	36.70	5	297.8	15	50.7	X
15KPA33A	15KPA33CA	33	36.9	40.4	5	276.1	2	54.7	X
15KPA36A	15KPA36CA	36	40.2	44.0	5	252.5	2	59.8	X
15KPA40A	15KPA40CA	40	44.7	48.9	5	229.5	2	65.8	X
15KPA43A	15KPA43CA	43	48.0	52.6	5	216.3	2	69.8	X
15KPA45A	15KPA45CA	45	50.3	55.0	5	207.4	2	72.8	X
15KPA48A	15KPA48CA	48	53.6	58.7	5	194.3	2	77.7	X
15KPA51A	15KPA51CA	51	57.0	62.4	5	182.1	2	82.9	X
15KPA54A	15KPA54CA	54	60.3	66.0	5	172.2	2	87.7	X
15KPA58A	15KPA58CA	58	64.8	70.9	5	161.0	2	93.8	X
15KPA60A	15KPA60CA	60	67.0	73.4	5	155.0	2	97.4	X
15KPA64A	15KPA64CA	64	71.5	78.3	5	144.9	2	104.2	X
15KPA70A	15KPA70CA	70	78.2	85.6	5	132.9	2	113.6	X
15KPA75A	15KPA75CA	75	83.8	91.7	5	123.8	2	122.0	X
15KPA78A	15KPA78CA	78	87.1	95.4	5	119.7	2	126.1	X
15KPA85A	15KPA85CA	85	94.9	104.0	5	109.7	2	137.6	X
15KPA90A	15KPA90CA	90	100.5	110.1	5	103.7	2	145.6	X
15KPA100A	15KPA100CA	100	111.7	122.3	5	93.6	2	161.3	X
15KPA110A	15KPA110CA	110	122.9	134.5	5	84.5	2	178.6	X
15KPA120A	15KPA120CA	120	134.0	146.8	5	78.5	2	192.3	X
15KPA130A	15KPA130CA	130	145.2	159.0	5	72.5	2	208.3	X
15KPA150A	15KPA150CA	150	167.6	183.5	5	62.4	2	241.9	X
15KPA160A	15KPA160CA	160	178.7	195.7	5	58.4	2	258.6	X
15KPA170A	15KPA170CA	170	189.9	207.9	5	55.4	2	272.7	X
15KPA180A	15KPA180CA	180	201.1	220.1	5	52.3	2	288.5	X
15KPA200A	15KPA200CA	200	223.4	244.6	5	47.3	2	319.1	X
15KPA220A	15KPA220CA	220	245.7	269.1	5	42.4	2	356.0	X
15KPA240A	15KPA240CA	240	268.1	293.5	5	39.3	2	384.6	X
15KPA260A	15KPA260CA	260	290.4	318.0	5	36.2	2	416.7	X
15KPA280A	15KPA280CA	280	312.8	342.4	5	33.2	2	454.5	X

For bidirectional type having V_R of 30 volts and less, the I_R limit is double.

For parts without A, the V_{BR} is ±10% and V_C is 5% higher than with A parts, the parts without A are currently available, but not recommended for new designs. The parts with A are preferred.

I-V Curve Characteristics

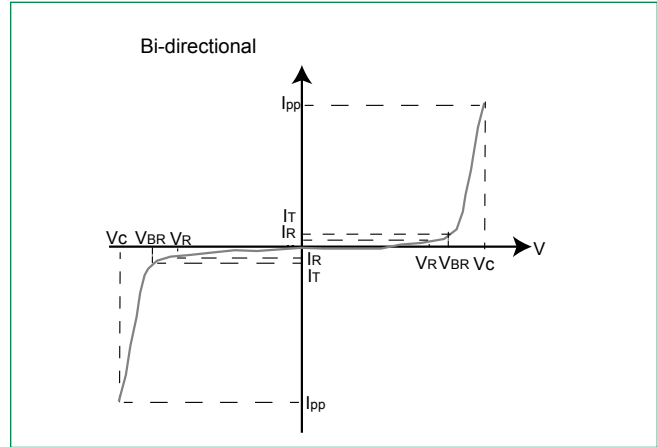
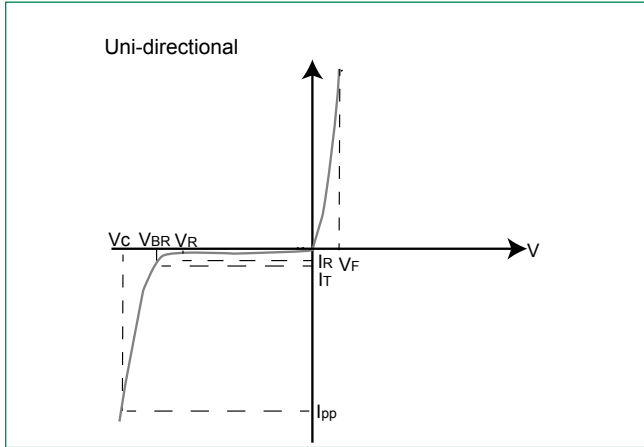

- P_{PPM} Peak Pulse Power Dissipation** – Max power dissipation
- V_R Stand-off Voltage** – Maximum voltage that can be applied to the TVS without operation
- V_{BR} Breakdown Voltage** – Maximum voltage that flows through the TVS at a specified test current (I_T)
- V_C Clamping Voltage** – Peak voltage measured across the TVS at a specified I_{ppm} (peak impulse current)
- I_R Reverse Leakage Current** – Current measured at V_R
- V_F Forward Voltage Drop for Uni-directional**

Ratings and Characteristic Curves ($T_A=25^\circ\text{C}$ unless otherwise noted)

Figure 1 - TVS Transients Clamping Waveform

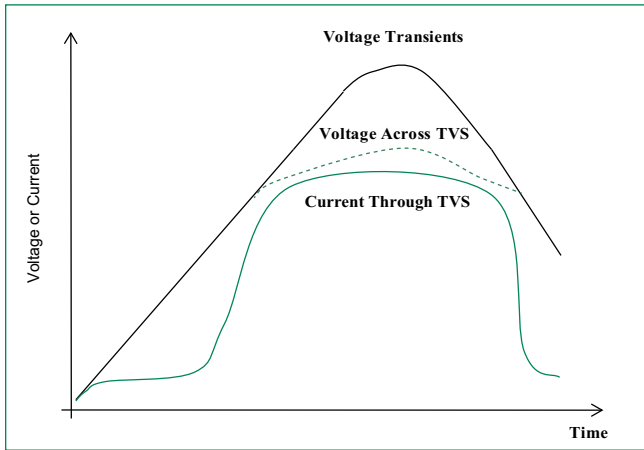
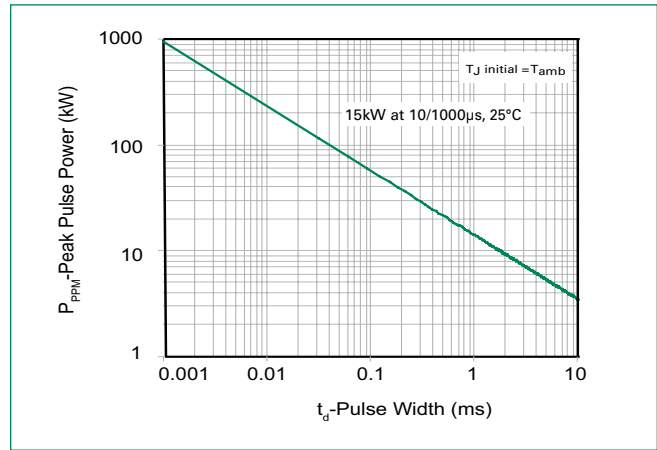

Figure 2 - Peak Pulse Power Rating Curve



Ratings and Characteristic Curves ($T_A=25^\circ\text{C}$ unless otherwise noted) (Continued)

Figure 3 - Peak Pulse Power Derating Curve

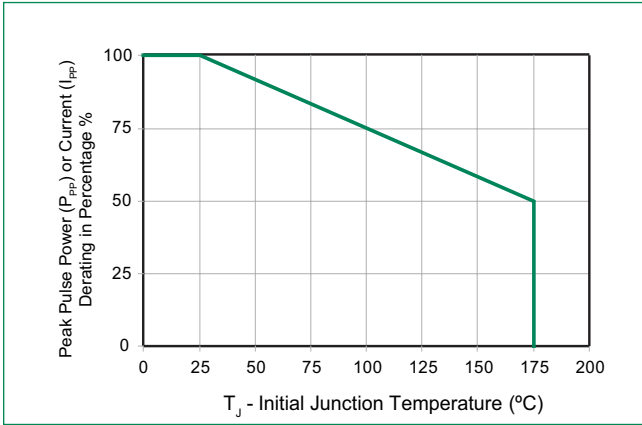

Figure 4 - Test Pulse Waveform

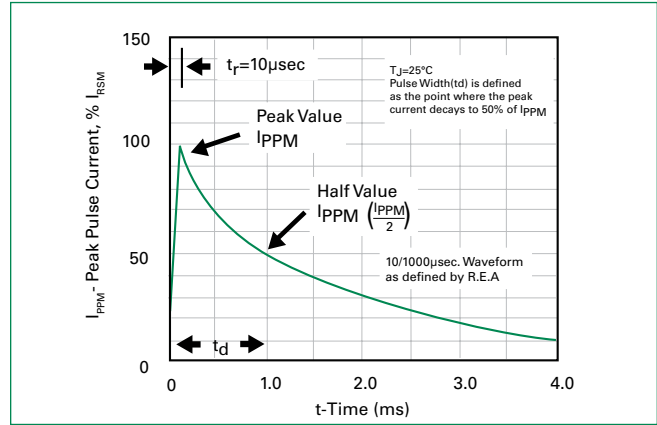

Figure 5 - Typical Junction Capacitance

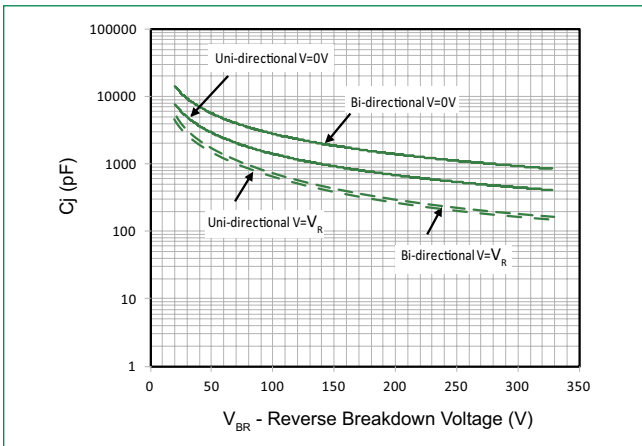

Figure 6 - Typical Transient Thermal Impedance

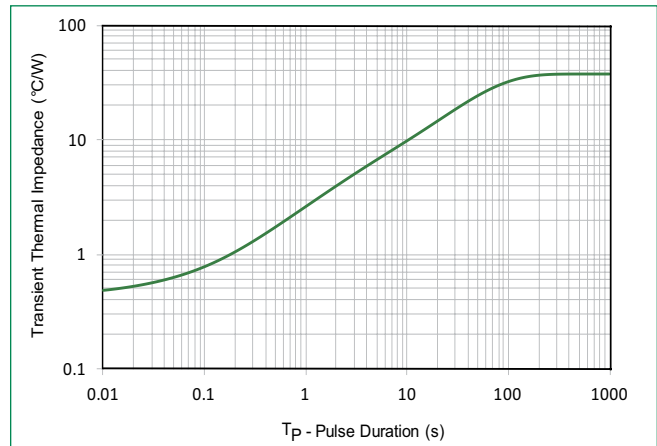

Figure 7 - Maximum Non-Repetitive Peak Forward Surge Current Uni-Directional Only

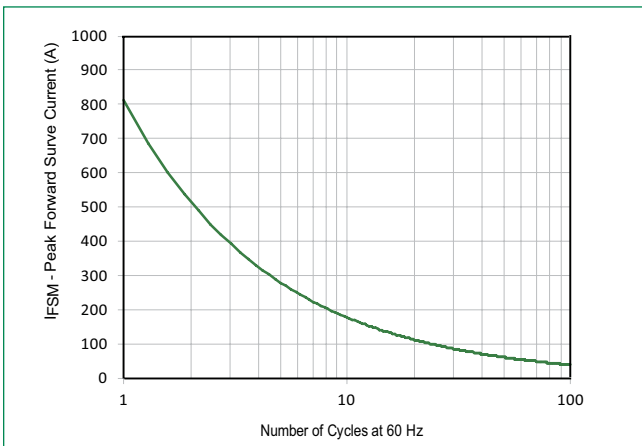
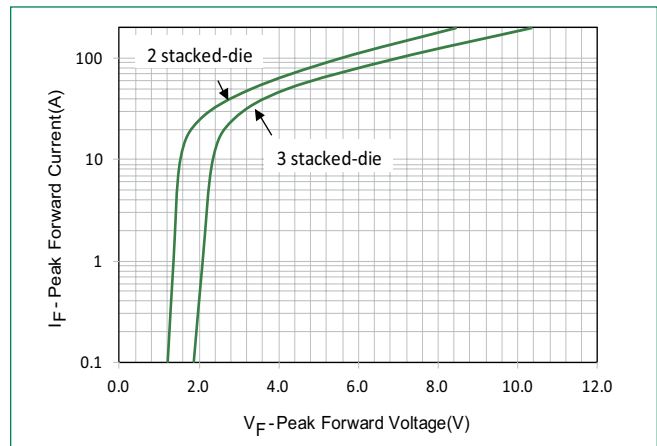
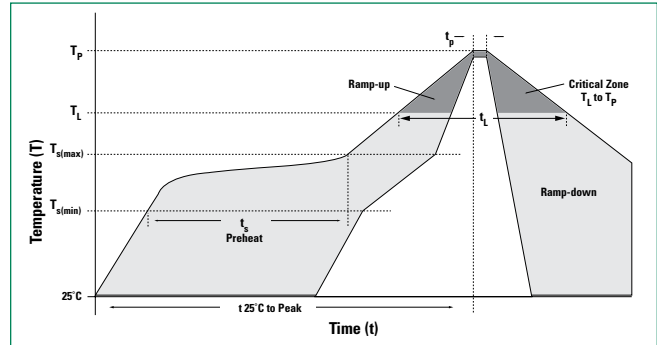

Figure 8 - Peak Forward Voltage Drop vs Peak Forward Current (Typical Values)



Soldering Parameters

Reflow Condition		Lead-free assembly
Pre Heat	- Temperature Min ($T_{s(min)}$)	150°C
	- Temperature Max ($T_{s(max)}$)	200°C
	- Time (min to max) (t_s)	60 – 180 secs
Average ramp up rate (Liquidus Temp (T_A) to peak		3°C/second max
$T_{s(max)}$ to T_A - Ramp-up Rate		3°C/second max
Reflow	- Temperature (T_A) (Liquidus)	217°C
	- Time (min to max) (t_s)	60 – 150 seconds
Peak Temperature (T_p)		260 ^{+0/-5} °C
Time within 5°C of actual peak Temperature (t_p)		20 – 40 seconds
Ramp-down Rate		6°C/second max
Time 25°C to peak Temperature (T_p)		8 minutes Max.
Do not exceed		260°C



Flow/Wave Soldering (Solder Dipping)

Peak Temperature :	265°C
Dipping Time :	10 seconds
Soldering :	1 time

Physical Specifications

Weight	0.07oz., 2.5g
Case	P600 molded plastic body over passivated junction.
Polarity	Color band denotes the cathode except Bipolar.
Terminal	Matte Tin axial leads, solderable per JESD22-B102.

Environmental Specifications

High Temp. Storage	JESD22-A103
HTRB	JESD22-A108
Temperature Cycling	JESD22-A104
H3TRB	JESD22-A101
RSH	JESD22-B106

Dimensions

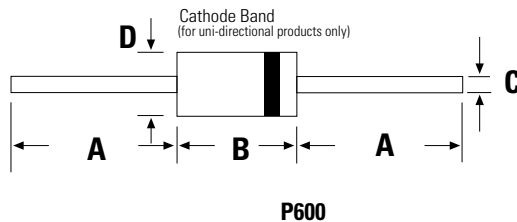

Dimensions	Inches		Millimeters	
	Min	Max	Min	Max
A	1.000	-	25.40	-
B	0.340	0.360	8.60	9.10
C	0.048	0.054	1.22	1.36
D	0.340	0.360	8.60	9.10

Part Numbering System

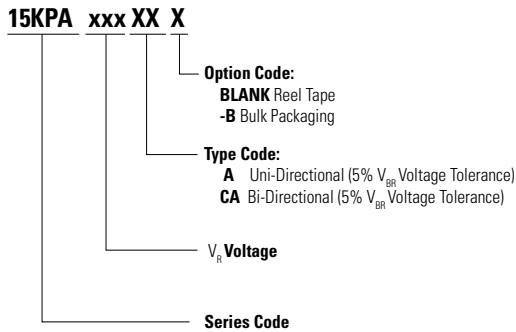

Part Marking System

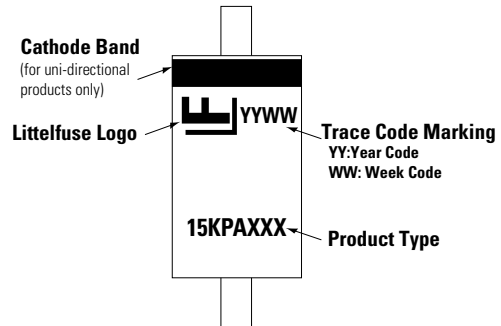

Packing Options

Part Number	Component Package	Quantity	Packaging Option	Packaging Specification
15KPAxxxXX	P600	800	Tape & Reel	EIA STD RS-296
15KPAxxxXX-B	P600	100	Bulk	Littelfuse Spec.

Tape and Reel Specification

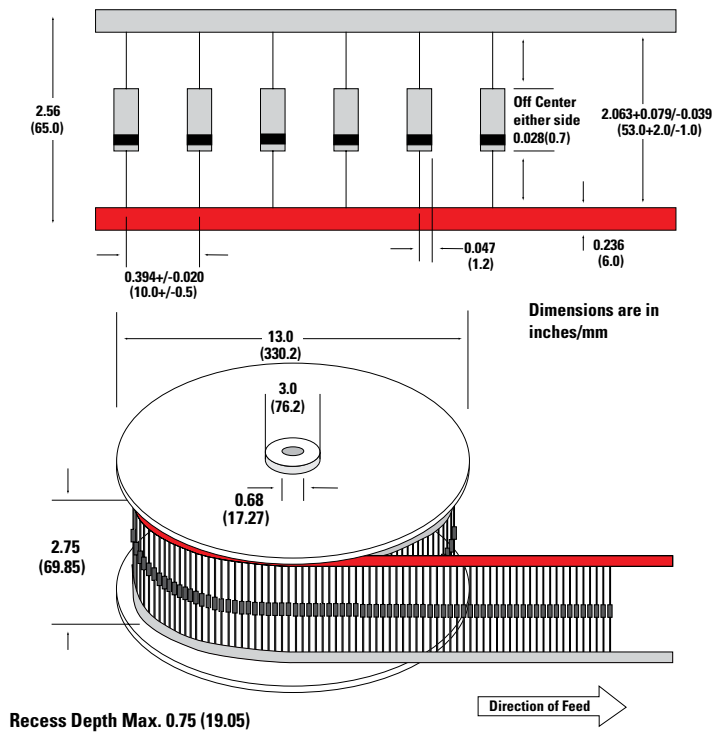

Looking for pricing, stock, or lifecycle information?

Click below to explore more details on WIN SOURCE:

 [View 15KPA36CA on WIN SOURCE](#)

 [Littelfuse Inc. Information](#)

Optimize Your Supply Chain with WIN SOURCE Solutions

-  Global Sourcing Solution
-  Obsolete Management
-  Cost Control Management
-  Shortage Management
-  Alternative Solution
-  Excess Inventory Management