

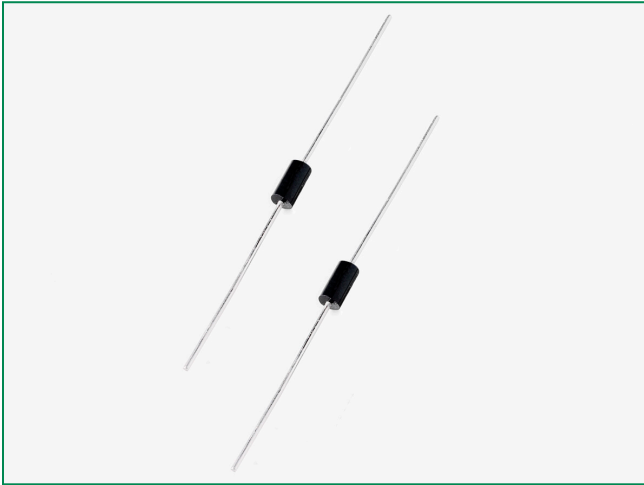

**THE DATASHEET OF  
1N5908RL4G**



## 1N5908



### Maximum Ratings and Thermal Characteristics

Rating	Symbol	Value	Unit
Peak Power Dissipation (Note 1) @ $T_L = 25^\circ\text{C}$	$P_{PK}$	1500	W
Steady State Power Dissipation @ $T_L = 75^\circ\text{C}$ , Lead Length = 3/8 ≤ Derated above $T_L = 75^\circ\text{C}$	$P_{PK}$	5.0	W
		50	mW/°C
Thermal Resistance, Junction-to-Lead	$R_{\theta JL}$	20	°C/W
Forward Surge Current (Note 2) @ $T_A = 25^\circ\text{C}$	$I_{FSM}$	200	A
Operating and Storage Temperature Range	$T_J, T_{stg}$	-65 to +175	°C/W

Stresses exceeding Maximum Ratings may damage the device. Maximum Ratings are stress ratings only. Functional operation above the Recommended Operating Conditions is not implied. Extended exposure to stresses above the Recommended Operating Conditions may affect device reliability.

1. Nonrepetitive current pulse per Figure 4 and derated above  $T_A = 25^\circ\text{C}$  per Figure 2.
2. 1/2 sine wave (or equivalent square wave),  $PW = 8.3 \text{ ms}$ , duty cycle = 4 pulses per minute maximum.

\*Bidirectional device will not be available in this device

### Description

These devices are designed to protect voltage sensitive components from high voltage, high-energy transients. They have excellent clamping capability, high surge capability, low zener impedance and fast response time. These devices are the Littelfuse exclusive, cost effective, highly reliable axial leaded package and are ideally suited for use in communication systems, numerical controls, process controls, medical equipment, business machines, power supplies and many other industrial/consumer applications, to protect CMOS, MOS and Bipolar integrated circuits.

### Features

- Working Peak Reverse Voltage Range - 5.0 V
- Peak Power - 1500 Watts @ 1 ms
- Maximum Clamp Voltage @ Peak Pulse Current
- Low Leakage < 5  $\mu\text{A}$  Above 10 V
- Response Time is Typically < 1 ns
- These are Pb-Free Devices\*

### Functional Diagram

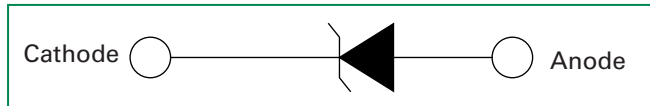

### Additional Information



Datasheet



Resources



Samples

**I-V Curve Characteristics** ( $T_A = 25^\circ\text{C}$  unless otherwise noted,  $V_F = 3.5\text{ V Max. @ } I_F$  (Note 3) = 100 A)

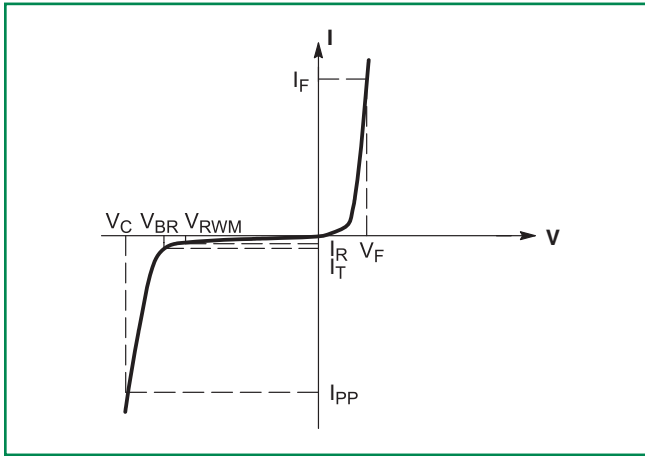

Symbol	Parameter
$I_{PP}$	Maximum Reverse Peak Pulse Current
$V_C$	Clamping Voltage @ $I_{PP}$
$V_{RWM}$	Working Peak Reverse Voltage
$I_R$	Maximum Reverse Leakage Current @ $V_{RWM}$
$V_{BR}$	Breakdown Voltage @ $I_T$
$I_T$	Test Current
$I_F$	Forward Current
$V_F$	Forward Voltage @ $I_F$

**Ratings and Characteristic Curves**

**Figure 1. Pulse Rating Curve**

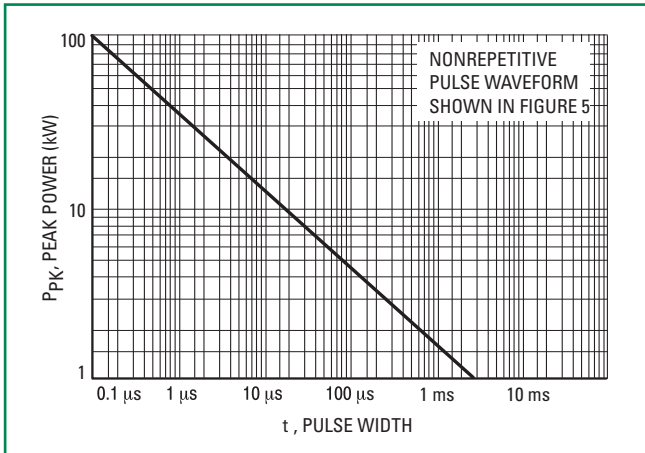

**Figure 2. Pulse Derating Curve**

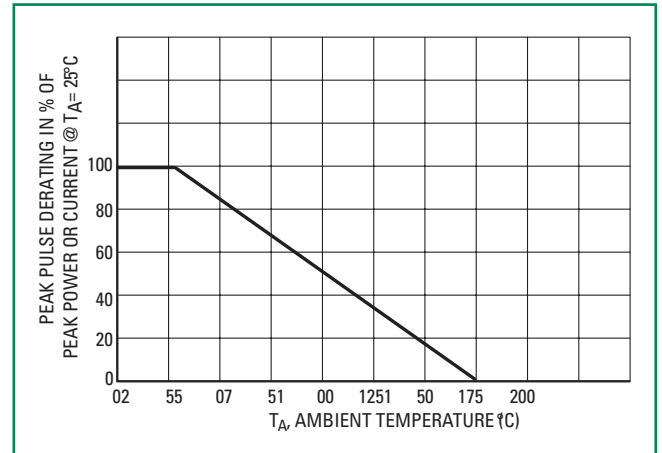

**Figure 3. Steady State Power Derating**

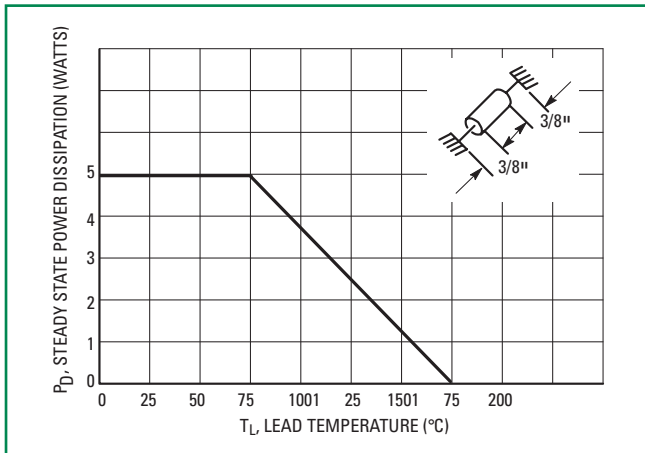

**Figure 4. Pulse Waveform**

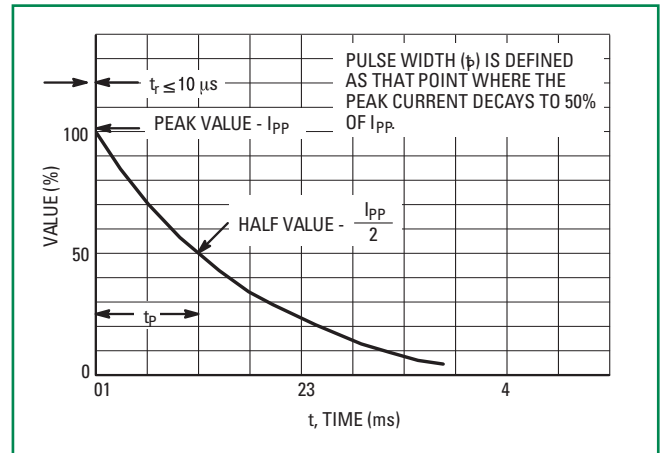

**Figure 5. Typical Derating Factor for Duty Cycle**

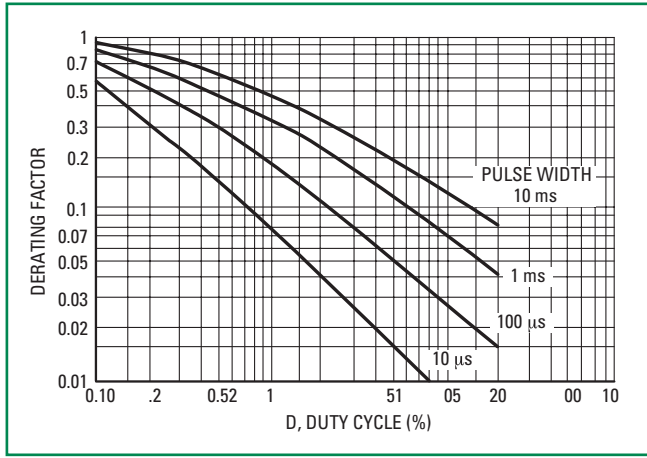

**Typical Protection Circuit**

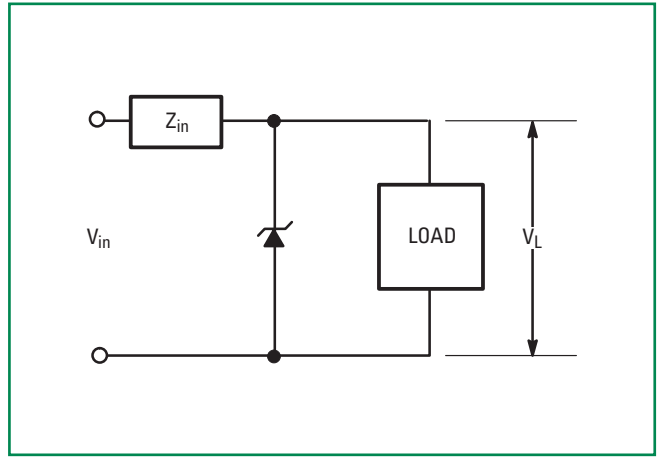

## Electrical Characteristics (TA = 25 ° C unless otherwise noted, VF = 3.5 V Max. @ IF (Note 3) = 53 A)

Device (Notes 4)	V <sub>RWM</sub> (Note 5) (Volts)	I <sub>R</sub> @ V <sub>RWM</sub> (μA)	Breakdown Voltage				V <sub>C</sub> (Volts) (Note 7)		
			V <sub>BR</sub> (V) (Note 6)			@ I <sub>T</sub>	@ I <sub>PP</sub> = 120 A	@ I <sub>PP</sub> = 60 A	@ I <sub>PP</sub> = 30 A
			Min	Nom	Max	(mA)			
1N5908	5.0	300	6.0	-	-	1.0	8.5	8.0	7.6

3. Square waveform, PW = 8.3 ms, Non-repetitive duty cycle.

4. 1N5908 is JEDEC registered as a unidirectional device only (no bidirectional option)

5. A transient suppressor is normally selected according to the maximum working peak reverse voltage (V<sub>RWM</sub>), which should be equal to or greater than the dc or continuous peak operating voltage level.

6. VBR measured at pulse test current I<sub>T</sub> at an ambient temperature of 25°C and minimum voltages in V<sub>BR</sub> are to be controlled.

7. Surge current waveform per Figure 4 and derate per Figure 2 of the General Data - 1500 W at the beginning of this group

**Dimensions**

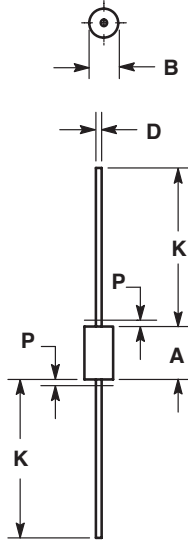

Dim	Inches		Millimeters	
	Min	Max	Min	Max
A	0.335	0.374	8.50	9.50
B	0.189	0.209	4.80	5.30
D	0.038	0.042	0.96	1.06
K	1.000	—	25.40	—
P	—	0.050	—	1.27

- NOTES:
1. DIMENSIONING AND TOLERANCING PER ANSI Y14.5M, 1982.
  2. CONTROLLING DIMENSION: INCH.
  3. LEAD FINISH AND DIAMETER UNCONTROLLED IN DIMENSION P.
  4. 041A-01 THRU 041A-03 OBSOLETE, NEW STANDARD 041A-04.

**Part Marking System**

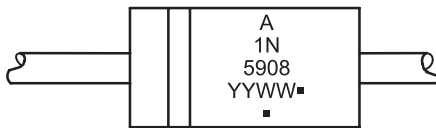

- A = Assembly Location
- 1N5908 = JEDEC Device Number
- YY = Year
- WW = Work Week
- = Pb-Free Package

(Note: Microdot may be in either location)

**ORDERING INFORMATION**

Device	Package	Shipping†
1N5908G	Axial Lead (Pb-Free)	500 Units/Box
1N5908RL4G	Axial Lead (Pb-Free)	1500/Tape & Reel

**Flow/Wave Soldering (Solder Dipping)**

<b>Peak Temperature :</b>	260°C
<b>Dipping Time :</b>	1/16" from the case for 10 seconds

**Physical Specifications**

<b>Case</b>	Void-free, transfer-molded, thermosetting plastic
<b>Leads</b>	Modified L-Bend providing more contact area to bond pads
<b>Finish</b>	All external surfaces are corrosion resistant and leads are readily solderable
<b>Mounting Position</b>	Any

**Disclaimer Notice** - Information furnished is believed to be accurate and reliable. However, users should independently evaluate the suitability of and test each product selected for their own applications. Littelfuse products are not designed for, and may not be used in, all applications. Read complete Disclaimer Notice at: [www.littelfuse.com/disclaimer-electronics](http://www.littelfuse.com/disclaimer-electronics).

## Looking for pricing, stock, or lifecycle information?

Click below to explore more details on WIN SOURCE:

 [View 1N5908RL4G on WIN SOURCE](#)

 [Littelfuse Inc. Information](#)

## Optimize Your Supply Chain with WIN SOURCE Solutions

-  Global Sourcing Solution
-  Obsolete Management
-  Cost Control Management
-  Shortage Management
-  Alternative Solution
-  Excess Inventory Management