



**THE DATASHEET OF
AD7502KNZ**



AD7501/AD7502/AD7503

FEATURES

- DTL/TTL/CMOS Direct Interface
- Power Dissipation: 30 μ W
- R_{ON} : 170 Ω
- Standard 16-Lead DIPs and 20-Terminal Surface Mount Packages

GENERAL DESCRIPTION

The AD7501 and AD7503 are monolithic CMOS, 8-channel analog multiplexers which switch one of eight inputs to a common output, depending on the state of three binary address lines and an “enable” input. The AD7503 is identical to the AD7501 except its “enable” logic is inverted. All digital inputs are TTL/DTL and CMOS logic compatible.

The AD7502 is a monolithic CMOS dual 4-channel analog multiplexer. Depending on the state of two binary address inputs and an “enable,” it switches two output buses to two of eight inputs.

Truth Tables

AD7501

A_2	A_1	A_0	EN	“ON”
0	0	0	1	1
0	0	1	1	2
0	1	0	1	3
0	1	1	1	4
1	0	0	1	5
1	0	1	1	6
1	1	0	1	7
1	1	1	1	8
X	X	X	0	None

AD7503

A_2	A_1	A_0	EN	“ON”
0	0	0	0	1
0	0	1	0	2
0	1	0	0	3
0	1	1	0	4
1	0	0	0	5
1	0	1	0	6
1	1	0	0	7
1	1	1	0	8
X	X	X	1	None

FUNCTIONAL BLOCK DIAGRAM
AD7501/AD7503

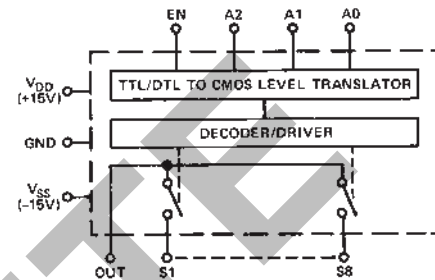

AD7502

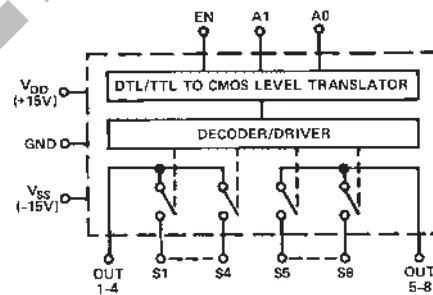

AD7502

A_1	A_0	EN	“ON”
0	0	1	1 & 5
0	1	1	2 & 6
1	0	1	3 & 7
1	1	1	4 & 8
X	X	0	None

REV. B

Information furnished by Analog Devices is believed to be accurate and reliable. However, no responsibility is assumed by Analog Devices for its use, nor for any infringements of patents or other rights of third parties that may result from its use. No license is granted by implication or otherwise under any patent or patent rights of Analog Devices. Trademarks and registered trademarks are the property of their respective companies.

AD7501/AD7502/AD7503—SPECIFICATIONS ($V_{DD} = +15\text{ V}$, $V_{SS} = -15\text{ V}$ unless otherwise noted.)

Parameter	Version ¹	Switch Condition	@ +25°C		Over Specified Temperature Range		Test Conditions
			AD7501, AD7503	AD7502	AD7501, AD7503	AD7502	
ANALOG SWITCH							
R_{ON}	All	ON	170 Ω typ, 300 Ω max	170 Ω typ, 300 Ω max			$-10\text{ V} \leq V_S \leq +10\text{ V}$ $I_S = 1.0\text{ mA}$ $V_S = 0\text{ V}$, $I_S = 1.0\text{ mA}$
R_{ON} vs. V_S	All	ON	20% typ	20% typ			
R_{ON} vs. Temperature	All	ON	0.5%/°C typ	0.5%/°C typ			
ΔR_{ON} Between Switches	All	ON	4% typ	4% typ			
R_{ON} vs. Temperature Between Switches	All	ON	$\pm 0.01\%/^{\circ}\text{C}$	$\pm 0.01\%/^{\circ}\text{C}$			$V_S = -10\text{ V}$, $V_{OUT} = +10\text{ V}$ and $V_S = +10\text{ V}$, $V_{OUT} = -10\text{ V}$ $V_S = -10\text{ V}$, $V_{OUT} = +10\text{ V}$ and $V_S = +10\text{ V}$, $V_{OUT} = -10\text{ V}$ AD7501/02: Enable LOW AD7503: Enable HIGH $V_S = 0$
I_S	K	OFF	0.2 nA typ, 2 nA max	0.2 nA typ, 2 nA max	50 nA max	50 nA max	
I_{OUT}	S	OFF	0.5 nA max	0.5 nA max	50 nA max	50 nA max	
	K	OFF	1 nA typ, 10 nA max	0.6 nA typ, 5 nA max	250 nA max	125 nA max	
$ I_{OUT} - I_S $	S	OFF	5 nA max	3 nA max	250 nA max	125 nA max	
	K	ON	12 nA max	7 nA max	300 nA max	175 nA max	
	S	ON	5.5 nA max	3.5 nA max	300 nA max	175 nA max	
	DIGITAL CONTROL						
V_{INL}	All				0.8 V max	0.8 V max	
V_{INH}	All				2.4 V min	2.4 V min	
I_{INL} or I_{INH}	All		10 nA typ	10 nA typ			
C_{IN}	All		3 pF typ	3 pF typ			
DYNAMIC CHARACTERISTICS							
t_{ON}	All		0.8 μs typ	0.8 μs typ			$V_{IN} = 0$ to $+5.0\text{ V}$ (See Test Circuit 2)
t_{OFF}	All		0.8 μs typ	0.8 μs typ			
C_S	All	OFF	5 pF typ	5 pF typ			
C_{OUT}	All	OFF	30 pF typ	15 pF typ			
C_{SOUT}	All	OFF	0.5 pF typ	0.5 pF typ			
C_{SS} Between Any Two Switches	All	OFF	0.5 pF typ	0.5 pF typ			
POWER SUPPLY							
I_{DD}	All		500 μA max	500 μA max	500 μA max	500 μA max	All Digital Inputs Low
I_{SS}	All		500 μA max	500 μA max	500 μA max	500 μA max	All Digital Inputs High
I_{DD}	All		800 μA max	800 μA max	800 μA max	800 μA max	
I_{SS}	All		800 μA max	800 μA max	800 μA max	800 μA max	

NOTES

¹KN version specified for 0°C to +70°C, KQ version for -25°C to +85°C; and SQ, SE versions for -55°C to +125°C.

Specifications subject to change without notice.

ABSOLUTE MAXIMUM RATINGS

($T_A = +25^{\circ}\text{C}$ unless otherwise noted)

V_{DD} to GND +17 V

V_{SS} to GND -17 V

V Between Any Switch Terminals¹ 25 V

Digital Input Voltage Range V_{DD} to GND

Overvoltage at V_{OUT} (V_S) V_{SS} , V_{DD}

Switch Current (I_S , Continuous One Channel) 35 mA

Switch Current (I_S , Surge One Channel)

1 ms Duration, 10% Duty Cycle 50 mA

Power Dissipation (Any Package)

Up to +75°C 450 mW

Derates above +75°C by 6 mW/°C

Operating Temperature

Commercial (KN Version) 0°C to +70°C

Industrial (KQ Version) -25°C to +85°C

Extended (SQ, SE Versions) -55°C to +125°C

Storage Temperature -65°C to +150°C

Lead Temperature (Soldering, 10 sec) +300°C

CAUTION

¹Do not apply voltages higher than V_{DD} and V_{SS} to any other terminal, especially when $V_{SS} = V_{DD} = 0\text{ V}$ all other pins should be at 0 V.

²The digital control inputs are diode protected; however, permanent damage may occur on unconnected units under high energy electrostatic fields. Keep unused units in conductive foam at all times.

CAUTION

ESD (electrostatic discharge) sensitive device. Electrostatic charges as high as 4000 V readily accumulate on the human body and test equipment and can discharge without detection. Although the AD7501, AD7502, and AD7503 feature proprietary ESD protection circuitry, permanent damage may occur on devices subjected to high energy electrostatic discharges. Therefore, proper ESD precautions are recommended to avoid performance degradation or loss of functionality.



AD7501/AD7502/AD7503

ORDERING GUIDE

Model ¹	Temperature Range	Package Options ²
AD7501KN	0°C to +70°C	N-16
AD7501KQ	-25°C to +85°C	Q-16
AD7501SQ	-55°C to +125°C	Q-16
AD7501SE	-55°C to +125°C	E-20A
AD7502KN	0°C to +70°C	N-16
AD7502KQ	-25°C to +85°C	Q-16
AD7502SQ	-55°C to +125°C	Q-16
AD7502SE	-55°C to +125°C	E-20A
AD7503KN	0°C to +70°C	N-16
AD7503KQ	-25°C to +85°C	Q-16
AD7503SQ	-55°C to +125°C	Q-16
AD7503SE	-55°C to +125°C	E-20A

NOTES

¹To order MIL-STD-883, Class B processed parts, add/883B to part number.

See the Analog Devices' 1990 Military Databook for military data sheet.

²E = LCC; N = PDIP; Q = CERDIP.

PIN CONFIGURATIONS

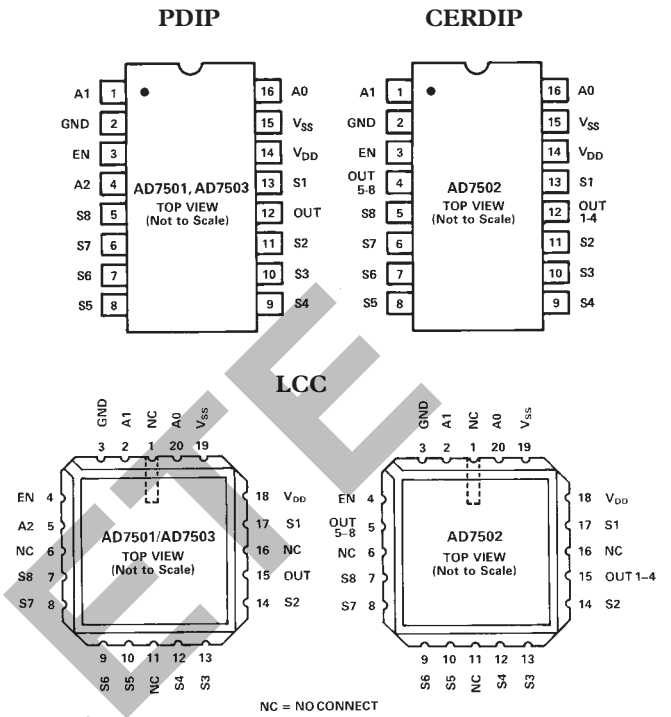

Typical Performance Characteristics

1. R_{ON} Versus V_S

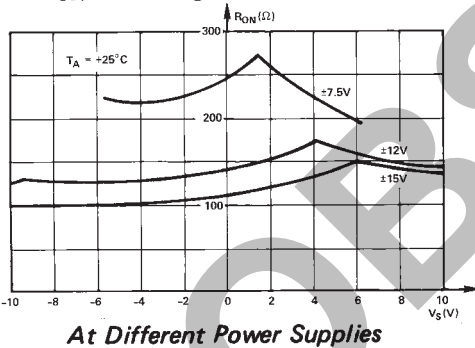

Figure 1a. R_{ON} vs. V_S At Different Power Supplies

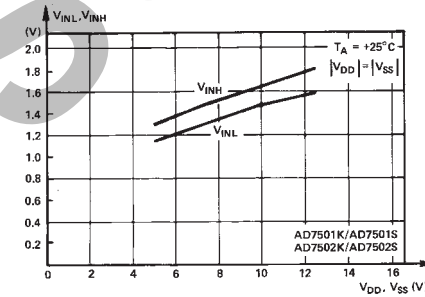

Figure 2a. Digital Threshold Voltage (V_{INH}, V_{INL}) vs. Power Supply

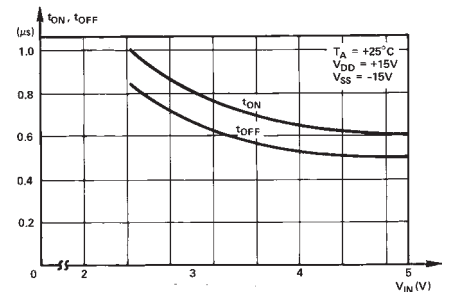

Figure 3. t_{ON}, t_{OFF} vs. Digital Input Voltage

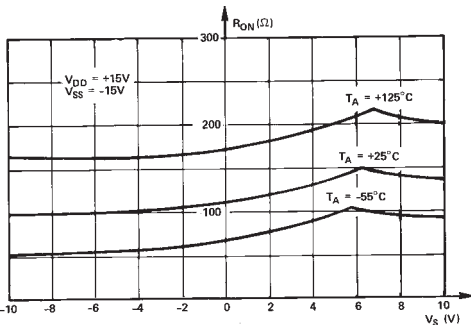

Figure 1b. R_{ON} vs. V_S At Different Temperatures

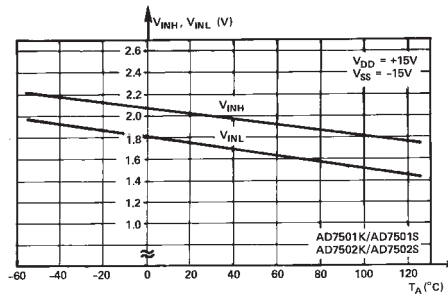

Figure 2b. Digital Threshold Voltage (V_{INH}, V_{INL}) vs. Temperature

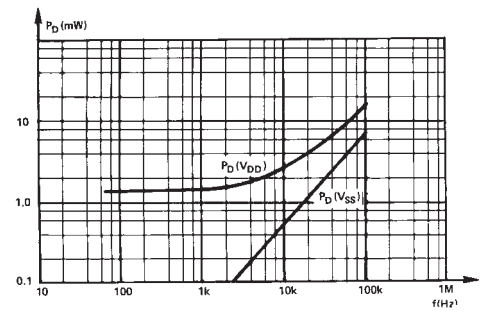
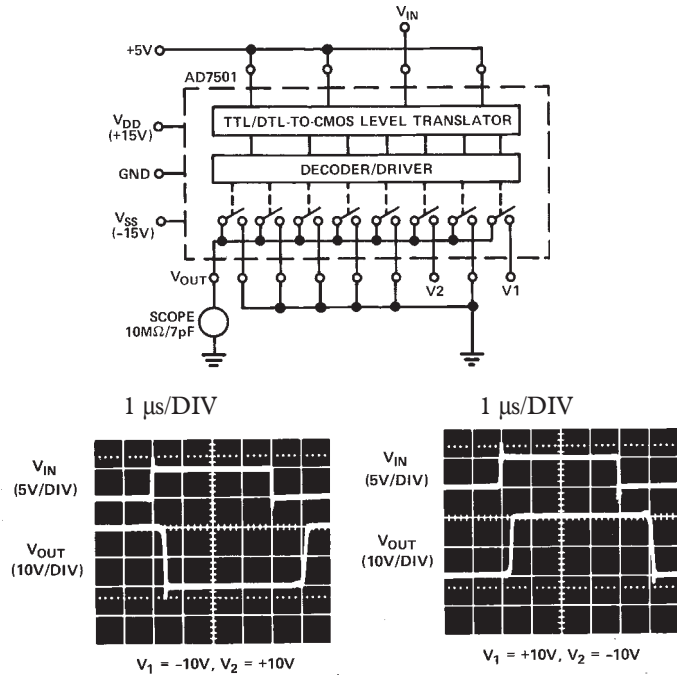

Figure 4. Power Dissipation vs. Logic Frequency (50% Duty Cycle)

AD7501/AD7502/AD7503

TYPICAL SWITCHING CHARACTERISTICS

TEST CIRCUIT 1



TEST CIRCUIT 2

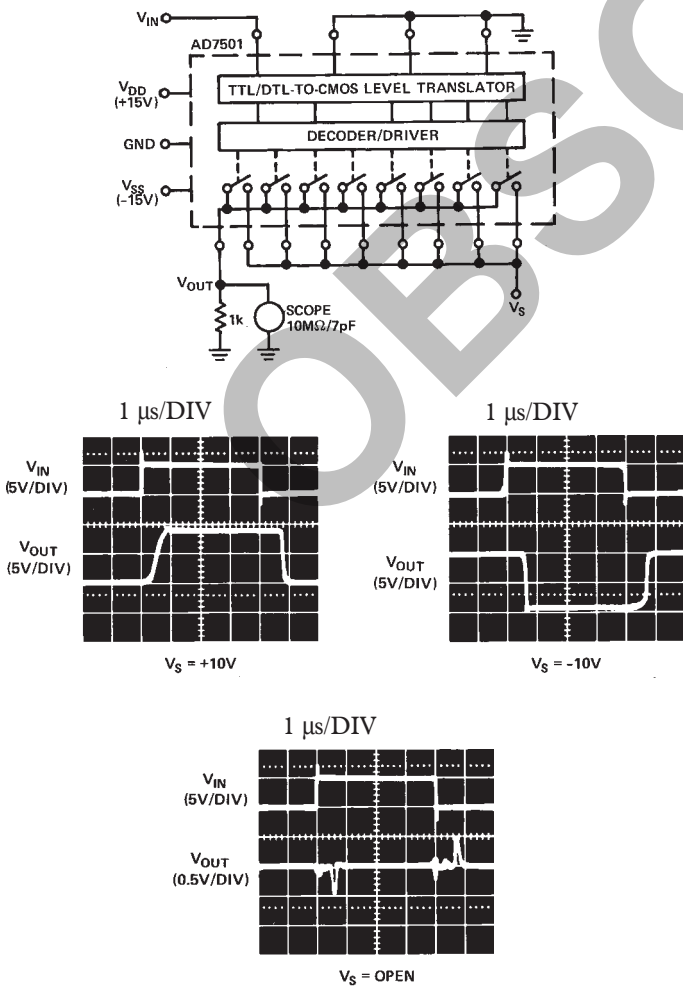

OUTLINE DIMENSIONS

16-Lead Plastic Dual In-Line Package [PDIP] (N-16)

Dimensions shown in inches and (millimeters)

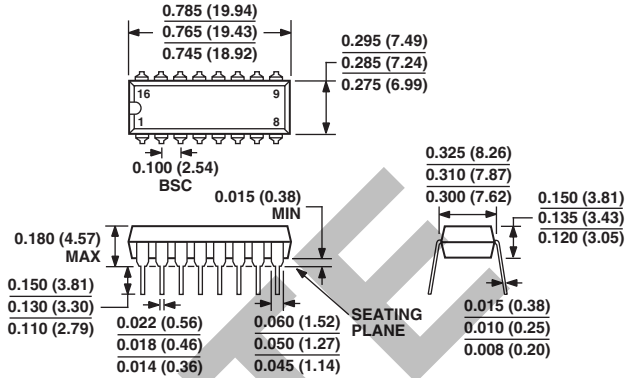

COMPLIANT TO JEDEC STANDARDS MO-095AC
CONTROLLING DIMENSIONS ARE IN INCHES; MILLIMETER DIMENSIONS (IN PARENTHESES) ARE ROUNDED-OFF INCH EQUIVALENTS FOR REFERENCE ONLY AND ARE NOT APPROPRIATE FOR USE IN DESIGN

16-Lead Ceramic Dual In-Line Package [CERDIP] (Q-16)

Dimensions shown in inches and (millimeters)

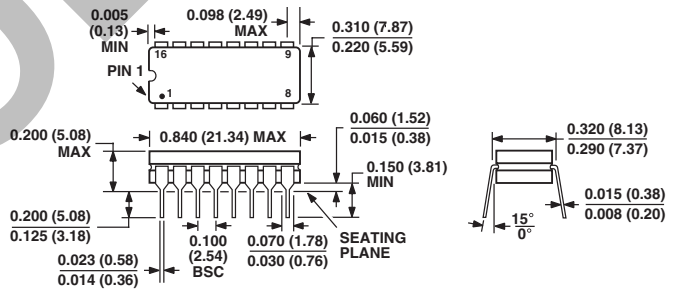

CONTROLLING DIMENSIONS ARE IN INCHES; MILLIMETERS DIMENSIONS (IN PARENTHESES) ARE ROUNDED-OFF INCH EQUIVALENTS FOR REFERENCE ONLY AND ARE NOT APPROPRIATE FOR USE IN DESIGN

20-Terminal Ceramic Leadless Chip Carrier [LCC] (E-20A)

Dimensions shown in inches and (millimeters)

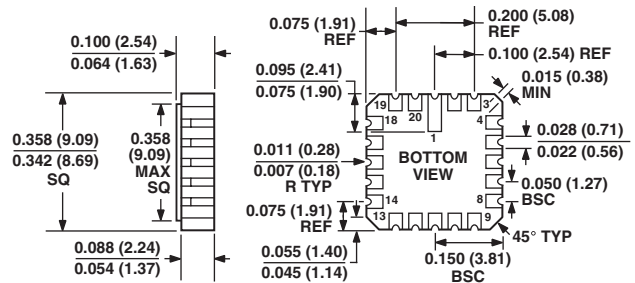

CONTROLLING DIMENSIONS ARE IN INCHES; MILLIMETERS DIMENSIONS (IN PARENTHESES) ARE ROUNDED-OFF INCH EQUIVALENTS FOR REFERENCE ONLY AND ARE NOT APPROPRIATE FOR USE IN DESIGN

C01129-0-7/03(B)

Looking for pricing, stock, or lifecycle information?

Click below to explore more details on WIN SOURCE:

 [View AD7502KNZ on WIN SOURCE](#)

 [Analog Devices Inc. Information](#)

Optimize Your Supply Chain with WIN SOURCE Solutions

-  Global Sourcing Solution
-  Obsolete Management
-  Cost Control Management
-  Shortage Management
-  Alternative Solution
-  Excess Inventory Management