



**THE DATASHEET OF  
AP2122AK-3.0TRG1**



## Description

The AP2122 series are positive voltage regulator ICs fabricated by CMOS process. Each of these ICs consists of a voltage reference, an error amplifier, a resistor network for setting output voltage, a current limit circuit for current protection and a chip enable circuit.

The AP2122 series feature high ripple rejection, low dropout voltage, low noise, high output voltage accuracy, and low current consumption which make them ideal for use in various battery-powered devices.

The AP2122 series have 1.5V, 1.8V, 2.5V, 2.8V, 3.0V, 3.2V and 3.3V versions.

The AP2122 are available in standard SOT-23-5 package.

## Features

- Low Dropout Voltage at  $I_{OUT} = 100\text{mA}$ : 150mV Typical (Except 1.5V Version)
- Low Standby Current: 0.1 $\mu\text{A}$  Typical
- Low Quiescent Current: 25 $\mu\text{A}$  Typical
- High Ripple Rejection: 70dB Typical ( $f = 10\text{kHz}$ )
- Maximum Output Current: More Than 150mA (300mA Limit)
- Extremely Low Noise: 30 $\mu\text{Vrms}$  (10Hz to 100kHz)
- Excellent Line Regulation: 4mV Typical
- Excellent Load Regulation: 12mV Typical
- High Output Voltage Accuracy:  $\pm 2\%$
- Excellent Line and Load Transient Response
- Compatible with Low ESR Ceramic Capacitor (as Low as 1 $\mu\text{F}$ )

## Pin Assignments

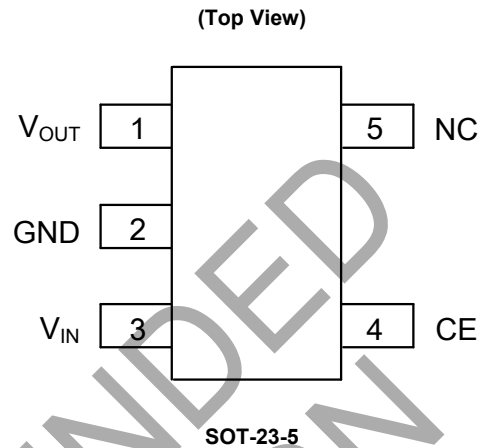

## Applications

- Mobile Phones, Cordless Phones
- MP3/4
- Portable Electronic Devices
- Cameras, Video Recorders
- Sub-board Power Supplies for Telecom Equipment
- Battery Powered Equipment

## Typical Applications Circuit (Note 1)

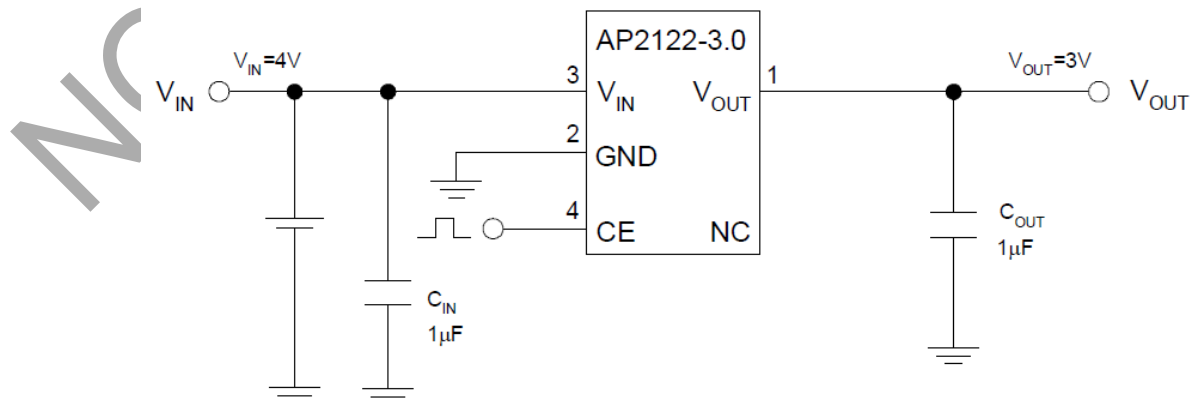

Note 1: Filter capacitors are required at the AP2122's input and output. 1 $\mu\text{F}$  capacitor is required at the input. The minimum output capacitance required for stability should be more than 1 $\mu\text{F}$  with ESR from 0.01 $\Omega$  to 100 $\Omega$ . Ceramic capacitors are recommended.

**Pin Descriptions**

Pin Number	Pin Name	Function
1	V <sub>OUT</sub>	Regulated output voltage
2	GND	Ground
3	V <sub>IN</sub>	Input voltage
4	CE	Active high enable input pin. Logic high=enable, logic low=shutdown
5	NC	No connection

**Functional Block Diagram**

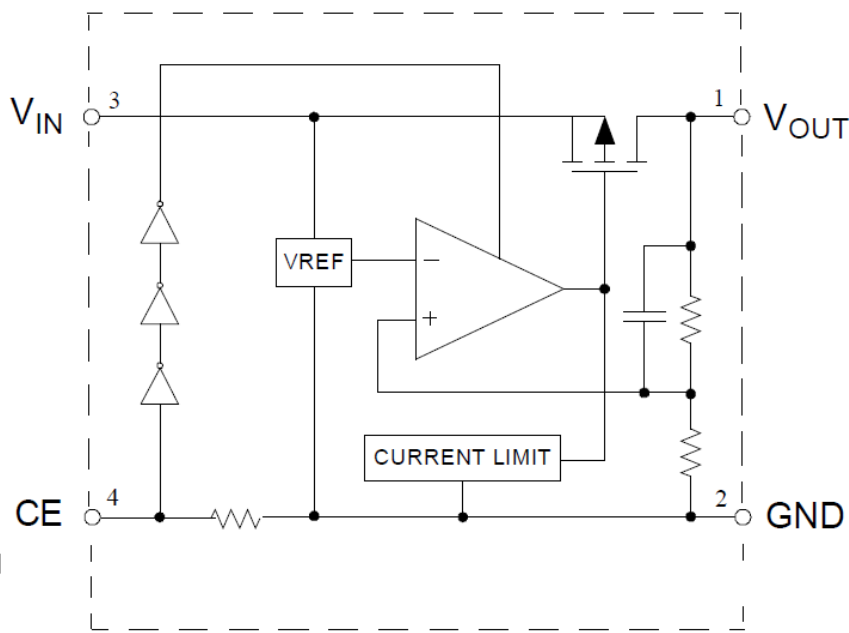

## Absolute Maximum Ratings (Note 2)

Symbol	Parameter	Rating	Unit
V <sub>IN</sub>	Input Voltage	6.5	V
V <sub>CE</sub>	Enable Input Voltage	-0.3 to V <sub>IN</sub> +0.3	V
I <sub>OUT</sub>	Output Current	300	mA
T <sub>J</sub>	Junction Temperature	+150	°C
T <sub>STG</sub>	Storage Temperature Range	-65 to +150	°C
T <sub>LEAD</sub>	Lead Temperature (Soldering, 10sec)	+260	°C
θ <sub>JA</sub>	Thermal Resistance (Note 3)	250	°C/W
ESD	ESD (Human Body Model)	2000	V
ESD	ESD (Machine Model)	200	V

Notes: 2. Stresses greater than those listed under "Absolute Maximum Ratings" may cause permanent damage to the device. These are stress ratings only, and functional operation of the device at these or any other conditions beyond those indicated under "Recommended Operating Conditions" is not implied. Exposure to "Absolute Maximum Ratings" for extended periods may affect device reliability.

3. Absolute maximum ratings indicate limits beyond which damage to the component may occur. Electrical specifications do not apply when operating the device outside of its operating ratings. The maximum allowable power dissipation is a function of the maximum junction temperature, T<sub>J(max)</sub>, the junction-to-ambient thermal resistance, θ<sub>JA</sub>, and the ambient temperature, T<sub>A</sub>. The maximum allowable power dissipation at any ambient temperature is calculated using: P<sub>D(max)</sub>=(T<sub>J(max)</sub> -T<sub>A</sub>)/ θ<sub>JA</sub>. Exceeding the maximum allowable power dissipation will result in excessive die temperature.

## Recommended Operating Conditions

Symbol	Parameter	Min	Max	Unit
V <sub>IN</sub>	Input Voltage	2	6	V
T <sub>J</sub>	Operating Junction Temperature Range	-40	+85	°C

## Electrical Characteristics

**AP2122-1.5 Electrical Characteristics** (@ $V_{IN} = 2.5V$ ,  $T_J = +25^\circ C$ ,  $C_{IN} = 1\mu F$ ,  $C_{OUT} = 1\mu F$ , **Bold** typeface applies over  $-40^\circ C \leq T_J \leq +85^\circ C$ , unless otherwise specified.)

Symbol	Parameter	Conditions	Min	Typ	Max	Unit
$V_{OUT}$	Output Voltage	$V_{IN} = 2.5V$ $1mA \leq I_{OUT} \leq 30mA$	1.47	1.5	1.53	V
$V_{IN}$	Input Voltage	—	—	—	6	V
$I_{OUT}$	Output Current	$V_{IN} - V_{OUT} = 1V$	150	—	—	mA
$V_{RLOAD}$	Load Regulation	$V_{IN} = 2.5V$ $1mA \leq I_{OUT} \leq 80mA$	—	12	40	mV
$V_{RLINE}$	Line Regulation	$2.3V \leq V_{IN} \leq 6V$ $I_{OUT} = 30mA$	—	4	16	mV
$V_{DROP}$	Dropout Voltage	$I_{OUT} = 10mA$	—	400	600	mV
		$I_{OUT} = 100mA$	—	400	600	
		$I_{OUT} = 150mA$	—	400	600	
$I_Q$	Quiescent Current	$V_{IN} = 2.5V$ , $I_{OUT} = 0mA$	—	25	50	$\mu A$
$I_{STD}$	Standby Current	$V_{IN} = 2.5V$ $V_{CE}$ in OFF Mode	—	0.1	1	$\mu A$
PSRR	Power Supply Rejection Ratio	Ripple 0.5Vp-p, $f = 10kHz$ $V_{IN} = 2.5V$	—	70	—	dB
$\Delta V_{OUT}/\Delta T$	Output Voltage Temperature Coefficient	$I_{OUT} = 30mA$	—	<b><math>\pm 150</math></b>	—	$\mu V/^\circ C$
$(\Delta V_{OUT}/V_{OUT})/\Delta T$			—	<b><math>\pm 100</math></b>	—	ppm/ $^\circ C$
$I_{LIMIT}$	Short Current Limit	$V_{OUT} = 0V$	—	50	—	mA
$V_{NOISE}$	RMS Output Noise	$T_A = +25^\circ C$ $10Hz \leq f \leq 100kHz$	—	30	—	$\mu V_{rms}$
—	CE "High" Voltage	CE Input Voltage "High"	1.5	—	—	V
—	CE "Low" Voltage	CE Input Voltage "Low"	—	—	0.25	V
$R_{PD}$	CE Pull-down Internal Resistance	—	2.5	5	10	$M\Omega$
$\theta_{JC}$	Thermal Resistance (Junction to Case)	SOT-23-5	—	73.9	—	$^\circ C/W$

### Electrical Characteristics (Cont.)

**AP2122-1.8 Electrical Characteristics** (@ $V_{IN} = 2.8V$ ,  $T_J = +25^\circ C$ ,  $C_{IN} = 1\mu F$ ,  $C_{OUT} = 1\mu F$ , **Bold** typeface applies over  $-40^\circ C \leq T_J \leq +85^\circ C$ , unless otherwise specified.)

Symbol	Parameter	Conditions	Min	Typ	Max	Unit
$V_{OUT}$	Output Voltage	$V_{IN} = 2.8V$ $1mA \leq I_{OUT} \leq 30mA$	1.764	1.8	1.836	V
$V_{IN}$	Input Voltage	—	—	—	6	V
$I_{OUT}$	Output Current	$V_{IN} - V_{OUT} = 1V$	150	—	—	mA
$V_{RLOAD}$	Load Regulation	$V_{IN} = 2.8V$ $1mA \leq I_{OUT} \leq 80mA$	—	12	40	mV
$V_{RLINE}$	Line Regulation	$2.3V \leq V_{IN} \leq 6V$ $I_{OUT} = 30mA$	—	4	16	mV
$V_{DROP}$	Dropout Voltage	$I_{OUT} = 10mA$	—	20	40	mV
		$I_{OUT} = 100mA$	—	150	300	
		$I_{OUT} = 150mA$	—	200	400	
$I_Q$	Quiescent Current	$V_{IN} = 2.8V$ , $I_{OUT} = 0mA$	—	25	50	$\mu A$
$I_{STD}$	Standby Current	$V_{IN} = 2.8V$ $V_{CE}$ in OFF Mode	—	0.1	1	$\mu A$
PSRR	Power Supply Rejection Ratio	Ripple 0.5Vp-p, $f = 10kHz$ $V_{IN} = 2.8V$	—	70	—	dB
$\Delta V_{OUT}/\Delta T$	Output Voltage Temperature Coefficient	$I_{OUT} = 30mA$	—	<b><math>\pm 180</math></b>	—	$\mu V/^\circ C$
$(\Delta V_{OUT}/V_{OUT})/\Delta T$			—	<b><math>\pm 100</math></b>	—	ppm/ $^\circ C$
$I_{LIMIT}$	Short Current Limit	$V_{OUT} = 0V$	—	50	—	mA
$V_{NOISE}$	RMS Output Noise	$T_A = +25^\circ C$ $10Hz \leq f \leq 100kHz$	—	30	—	$\mu V_{rms}$
—	CE "High" Voltage	CE Input Voltage "High"	1.5	—	—	V
—	CE "Low" Voltage	CE Input Voltage "Low"	—	—	0.25	V
$R_{PD}$	CE Pull-down Internal Resistance	—	2.5	5	10	$M\Omega$
$\theta_{JC}$	Thermal Resistance (Junction to Case)	SOT-23-5	—	73.9	—	$^\circ C/W$

## Electrical Characteristics (Cont.)

**AP2122-2.5 Electrical Characteristics** (@ $V_{IN} = 3.5V$ ,  $T_J = +25^\circ C$ ,  $C_{IN} = 1\mu F$ ,  $C_{OUT} = 1\mu F$ , **Bold** typeface applies over  $-40^\circ C \leq T_J \leq +85^\circ C$ , unless otherwise specified.)

Symbol	Parameter	Conditions	Min	Typ	Max	Unit
$V_{OUT}$	Output Voltage	$V_{IN} = 3.5V$ $1mA \leq I_{OUT} \leq 30mA$	2.45	2.5	2.55	V
$V_{IN}$	Input Voltage	—	—	—	6	V
$I_{OUT}$	Output Current	$V_{IN} - V_{OUT} = 1V$	150	—	—	mA
$V_{RLOAD}$	Load Regulation	$V_{IN} = 3.5V$ $1mA \leq I_{OUT} \leq 80mA$	—	12	40	mV
$V_{RLINE}$	Line Regulation	$3V \leq V_{IN} \leq 6V$ $I_{OUT} = 30mA$	—	4	16	mV
$V_{DROP}$	Dropout Voltage	$I_{OUT} = 10mA$	—	20	40	mV
		$I_{OUT} = 100mA$	—	150	300	
		$I_{OUT} = 150mA$	—	200	400	
$I_Q$	Quiescent Current	$V_{IN} = 3.5V$ , $I_{OUT} = 0mA$	—	25	50	$\mu A$
$I_{STD}$	Standby Current	$V_{IN} = 3.5V$ $V_{CE}$ in OFF Mode	—	0.1	1	$\mu A$
PSRR	Power Supply Rejection Ratio	Ripple 0.5Vp-p, $f = 10kHz$ $V_{IN} = 3.5V$	—	70	—	dB
$\Delta V_{OUT}/\Delta T$	Output Voltage Temperature Coefficient	$I_{OUT} = 30mA$	—	<b><math>\pm 250</math></b>	—	$\mu V/^\circ C$
$(\Delta V_{OUT}/V_{OUT})/\Delta T$			—	<b><math>\pm 100</math></b>	—	ppm/ $^\circ C$
$I_{LIMIT}$	Short Current Limit	$V_{OUT} = 0V$	—	50	—	mA
$V_{NOISE}$	RMS Output Noise	$T_A = +25^\circ C$ $10Hz \leq f \leq 100kHz$	—	30	—	$\mu V_{rms}$
—	CE "High" Voltage	CE Input Voltage "High"	1.5	—	—	V
—	CE "Low" Voltage	CE Input Voltage "Low"	—	—	0.25	V
$R_{PD}$	CE Pull-down Internal Resistance	—	2.5	5	10	$M\Omega$
$\theta_{JC}$	Thermal Resistance (Junction to Case)	SOT-23-5	—	73.9	—	$^\circ C/W$

### Electrical Characteristics (Cont.)

**AP2122-2.8 Electrical Characteristics** (@ $V_{IN} = 3.8V$ ,  $T_J = +25^\circ C$ ,  $C_{IN} = 1\mu F$ ,  $C_{OUT} = 1\mu F$ , **Bold** typeface applies over  $-40^\circ C \leq T_J \leq +85^\circ C$ , unless otherwise specified.)

Symbol	Parameter	Conditions	Min	Typ	Max	Unit
$V_{OUT}$	Output Voltage	$V_{IN} = 3.8V$ $1mA \leq I_{OUT} \leq 30mA$	2.744	2.8	2.856	V
$V_{IN}$	Input Voltage	—	—	—	6	V
$I_{OUT}$	Output Current	$V_{IN} - V_{OUT} = 1V$	150	—	—	mA
$V_{RLOAD}$	Load Regulation	$V_{IN} = 3.8V$ $1mA \leq I_{OUT} \leq 80mA$	—	12	40	mV
$V_{RLINE}$	Line Regulation	$3.3V \leq V_{IN} \leq 6V$ $I_{OUT} = 30mA$	—	4	16	mV
$V_{DROP}$	Dropout Voltage	$I_{OUT} = 10mA$	—	20	40	mV
		$I_{OUT} = 100mA$	—	150	300	
		$I_{OUT} = 150mA$	—	200	400	
$I_Q$	Quiescent Current	$V_{IN} = 3.8V$ , $I_{OUT} = 0mA$	—	25	50	$\mu A$
$I_{STD}$	Standby Current	$V_{IN} = 3.8V$ $V_{CE}$ in OFF Mode	—	0.1	1	$\mu A$
PSRR	Power Supply Rejection Ratio	Ripple 0.5Vp-p, $f = 10kHz$ $V_{IN} = 3.8V$	—	70	—	dB
$\Delta V_{OUT}/\Delta T$	Output Voltage Temperature Coefficient	$I_{OUT} = 30mA$	—	<b><math>\pm 280</math></b>	—	$\mu V/^\circ C$
$(\Delta V_{OUT}/V_{OUT})/\Delta T$			—	<b><math>\pm 100</math></b>	—	ppm/ $^\circ C$
$I_{LIMIT}$	Short Current Limit	$V_{OUT} = 0V$	—	50	—	mA
$V_{NOISE}$	RMS Output Noise	$T_A = +25^\circ C$ $10Hz \leq f \leq 100kHz$	—	30	—	$\mu V_{rms}$
—	CE "High" Voltage	CE Input Voltage "High"	1.5	—	—	V
—	CE "Low" Voltage	CE Input Voltage "Low"	—	—	0.25	V
$R_{PD}$	CE Pull-down Internal Resistance	—	2.5	5	10	$M\Omega$
$\theta_{JC}$	Thermal Resistance (Junction to Case)	SOT-23-5	—	73.9	—	$^\circ C/W$

### Electrical Characteristics (Cont.)

**AP2122-3.0 Electrical Characteristics** (@ $V_{IN} = 4V$ ,  $T_J = +25^\circ C$ ,  $C_{IN} = 1\mu F$ ,  $C_{OUT} = 1\mu F$ , **Bold** typeface applies over  $-40^\circ C \leq T_J \leq +85^\circ C$ , unless otherwise specified.)

Symbol	Parameter	Conditions	Min	Typ	Max	Unit
$V_{OUT}$	Output Voltage	$V_{IN} = 4V$ $1mA \leq I_{OUT} \leq 30mA$	2.94	3.0	3.06	V
$V_{IN}$	Input Voltage	—	—	—	6	V
$I_{OUT}$	Output Current	$V_{IN} - V_{OUT} = 1V$	150	—	—	mA
$V_{RLOAD}$	Load Regulation	$V_{IN} = 4V$ $1mA \leq I_{OUT} \leq 80mA$	—	12	40	mV
$V_{RLINE}$	Line Regulation	$3.5V \leq V_{IN} \leq 6V$ $I_{OUT} = 30mA$	—	4	16	mV
$V_{DROP}$	Dropout Voltage	$I_{OUT} = 10mA$	—	20	40	mV
		$I_{OUT} = 100mA$	—	150	300	
		$I_{OUT} = 150mA$	—	200	400	
$I_Q$	Quiescent Current	$V_{IN} = 4V$ , $I_{OUT} = 0mA$	—	25	50	$\mu A$
$I_{STD}$	Standby Current	$V_{IN} = 4V$ $V_{CE}$ in OFF Mode	—	0.1	1	$\mu A$
PSRR	Power Supply Rejection Ratio	Ripple 0.5Vp-p, $f = 10kHz$ $V_{IN} = 4V$	—	70	—	dB
$\Delta V_{OUT}/\Delta T$	Output Voltage Temperature Coefficient	$I_{OUT} = 30mA$	—	<b><math>\pm 300</math></b>	—	$\mu V/^\circ C$
$(\Delta V_{OUT}/V_{OUT})/\Delta T$			—	<b><math>\pm 100</math></b>	—	ppm/ $^\circ C$
$I_{LIMIT}$	Short Current Limit	$V_{OUT} = 0V$	—	50	—	mA
$V_{NOISE}$	RMS Output Noise	$T_A = +25^\circ C$ $10Hz \leq f \leq 100kHz$	—	30	—	$\mu V_{rms}$
—	CE "High" Voltage	CE Input Voltage "High"	1.5	—	—	V
—	CE "Low" Voltage	CE Input Voltage "Low"	—	—	0.25	V
$R_{PD}$	CE Pull-down Internal Resistance	—	2.5	5	10	$M\Omega$
$\theta_{JC}$	Thermal Resistance (Junction to Case)	SOT-23-5	—	73.9	—	$^\circ C/W$

### Electrical Characteristics (Cont.)

**AP2122-3.2 Electrical Characteristics** (@ $V_{IN} = 4.2V$ ,  $T_J = +25^\circ C$ ,  $C_{IN} = 1\mu F$ ,  $C_{OUT} = 1\mu F$ , **Bold** typeface applies over  $-40^\circ C \leq T_J \leq +85^\circ C$ , unless otherwise specified.)

Symbol	Parameter	Conditions	Min	Typ	Max	Unit
$V_{OUT}$	Output Voltage	$V_{IN} = 4.2V$ $1mA \leq I_{OUT} \leq 30mA$	3.136	3.2	3.264	V
$V_{IN}$	Input Voltage	—	—	—	6	V
$I_{OUT}$	Output Current	$V_{IN} - V_{OUT} = 1V$	150	—	—	mA
$V_{RLOAD}$	Load Regulation	$V_{IN} = 4.2V$ $1mA \leq I_{OUT} \leq 80mA$	—	12	40	mV
$V_{RLINE}$	Line Regulation	$3.7V \leq V_{IN} \leq 6V$ $I_{OUT} = 30mA$	—	4	16	mV
$V_{DROP}$	Dropout Voltage	$I_{OUT} = 10mA$	—	20	40	mV
		$I_{OUT} = 100mA$	—	150	300	
		$I_{OUT} = 150mA$	—	200	400	
$I_Q$	Quiescent Current	$V_{IN} = 4.2V$ , $I_{OUT} = 0mA$	—	25	50	$\mu A$
$I_{STD}$	Standby Current	$V_{IN} = 4.2V$ $V_{CE}$ in OFF Mode	—	0.1	1	$\mu A$
PSRR	Power Supply Rejection Ratio	Ripple 0.5Vp-p, $f = 10kHz$ $V_{IN} = 4.2V$	—	70	—	dB
$\Delta V_{OUT}/\Delta T$	Output Voltage Temperature Coefficient	$I_{OUT} = 30mA$	—	<b><math>\pm 320</math></b>	—	$\mu V/^\circ C$
$(\Delta V_{OUT}/V_{OUT})/\Delta T$			—	<b><math>\pm 100</math></b>	—	ppm/ $^\circ C$
$I_{LIMIT}$	Short Current Limit	$V_{OUT} = 0V$	—	50	—	mA
$V_{NOISE}$	RMS Output Noise	$T_A = +25^\circ C$ $10Hz \leq f \leq 100kHz$	—	30	—	$\mu V_{rms}$
—	CE "High" Voltage	CE Input Voltage "High"	1.5	—	—	V
—	CE "Low" Voltage	CE Input Voltage "Low"	—	—	0.25	V
$R_{PD}$	CE Pull-down Internal Resistance	—	2.5	5	10	$M\Omega$
$\theta_{JC}$	Thermal Resistance (Junction to Case)	SOT-23-5	—	73.9	—	$^\circ C/W$

## Electrical Characteristics (Cont.)

**AP2122-3.3 Electrical Characteristics** (@ $V_{IN} = 4.3V$ ,  $T_J = +25^\circ C$ ,  $C_{IN} = 1\mu F$ ,  $C_{OUT} = 1\mu F$ , **Bold** typeface applies over  $-40^\circ C \leq T_J \leq +85^\circ C$ , unless otherwise specified.)

Symbol	Parameter	Conditions	Min	Typ	Max	Unit
$V_{OUT}$	Output Voltage	$V_{IN} = 4.3V$ $1mA \leq I_{OUT} \leq 30mA$	3.234	3.3	3.366	V
$V_{IN}$	Input Voltage	—	—	—	6	V
$I_{OUT}$	Output Current	$V_{IN} - V_{OUT} = 1V$	150	—	—	mA
$V_{RLOAD}$	Load Regulation	$V_{IN} = 4.3V$ $1mA \leq I_{OUT} \leq 80mA$	—	12	40	mV
$V_{RLINE}$	Line Regulation	$3.8V \leq V_{IN} \leq 6V$ $I_{OUT} = 30mA$	—	4	16	mV
$V_{DROP}$	Dropout Voltage	$I_{OUT} = 10mA$	—	20	40	mV
		$I_{OUT} = 100mA$	—	150	300	
		$I_{OUT} = 150mA$	—	200	400	
$I_Q$	Quiescent Current	$V_{IN} = 4.3V$ , $I_{OUT} = 0mA$	—	25	50	$\mu A$
$I_{STD}$	Standby Current	$V_{IN} = 4.3V$ $V_{CE}$ in OFF Mode	—	0.1	1	$\mu A$
PSRR	Power Supply Rejection Ratio	Ripple 0.5Vp-p, $f = 10kHz$ $V_{IN} = 4.3V$	—	70	—	dB
$\Delta V_{OUT}/\Delta T$	Output Voltage Temperature Coefficient	$I_{OUT} = 30mA$	—	<b><math>\pm 330</math></b>	—	$\mu V/^\circ C$
$(\Delta V_{OUT}/V_{OUT})/\Delta T$			—	<b><math>\pm 100</math></b>	—	ppm/ $^\circ C$
$I_{LIMIT}$	Short Current Limit	$V_{OUT} = 0V$	—	50	—	mA
$V_{NOISE}$	RMS Output Noise	$T_A = +25^\circ C$ $10Hz \leq f \leq 100kHz$	—	30	—	$\mu V_{rms}$
—	CE "High" Voltage	CE Input Voltage "High"	1.5	—	—	V
—	CE "Low" Voltage	CE Input Voltage "Low"	—	—	0.25	V
$R_{PD}$	CE Pull-down Internal Resistance	—	2.5	5	10	$M\Omega$
$\theta_{JC}$	Thermal Resistance (Junction to Case)	SOT-23-5	—	73.9	—	$^\circ C/W$

**Performance Characteristics**

**Output Voltage vs. Output Current**

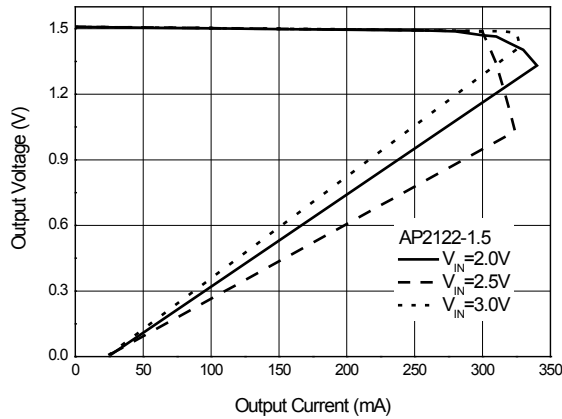

**Output Voltage vs. Output Current**

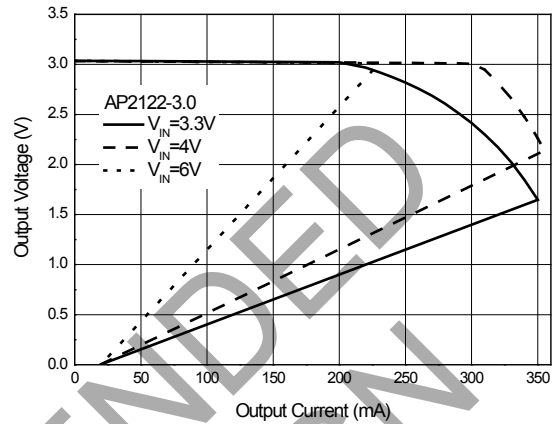

**Output Voltage vs. Input Voltage**

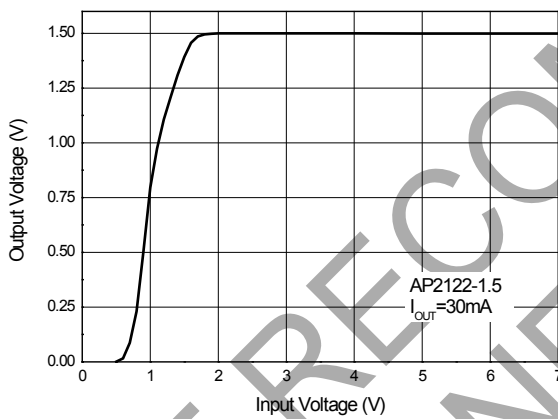

**Output Voltage vs. Input Voltage**

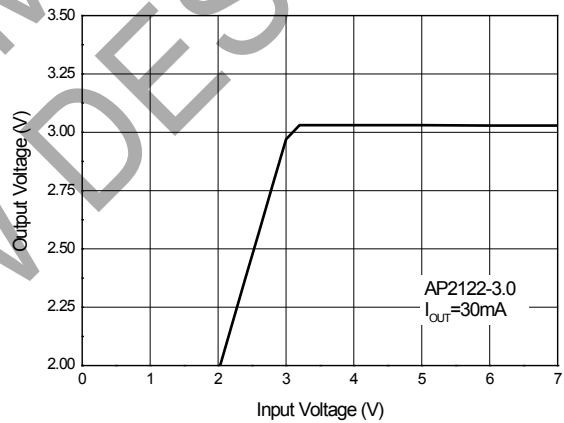

**Dropout Voltage vs. Output Current**

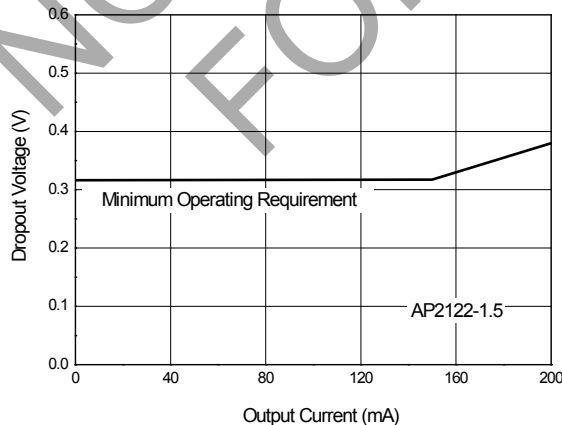

**Dropout Voltage vs. Output Current**

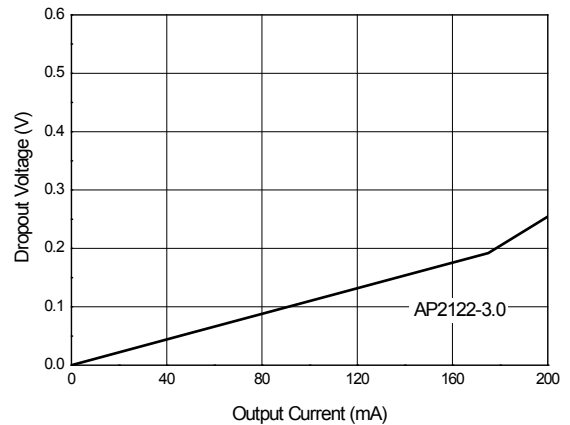

**Performance Characteristics (Cont.)**

**Output Voltage vs. Junction Temperature**

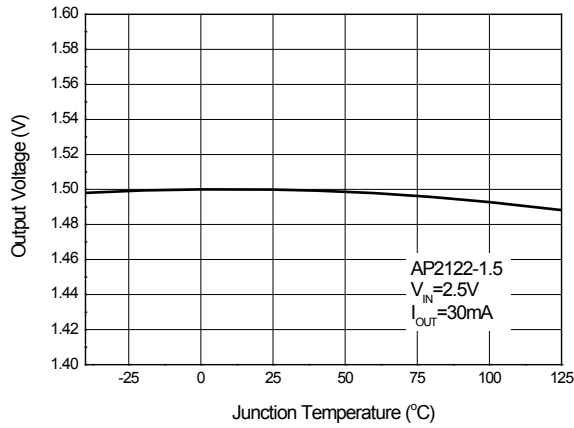

**Output Voltage vs. Junction Temperature**

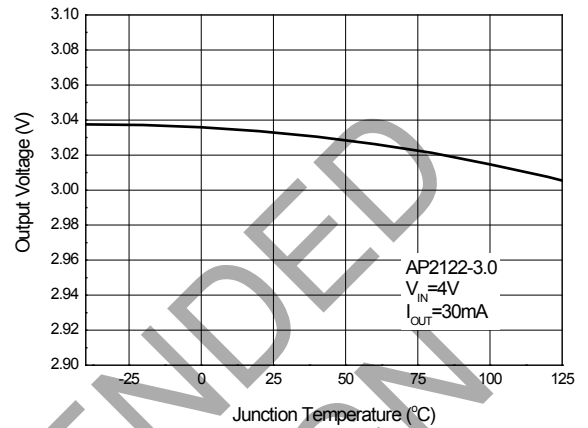

**Supply Current vs. Input Voltage**

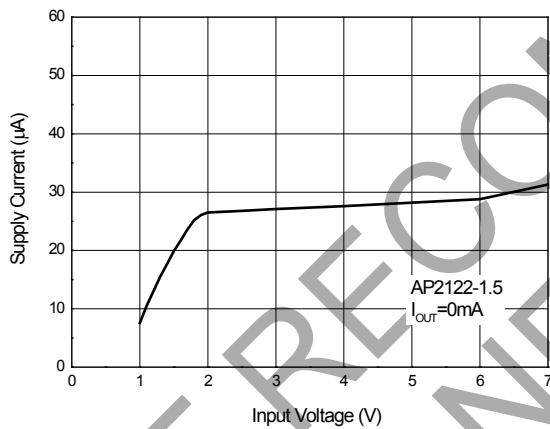

**Supply Current vs. Input Voltage**

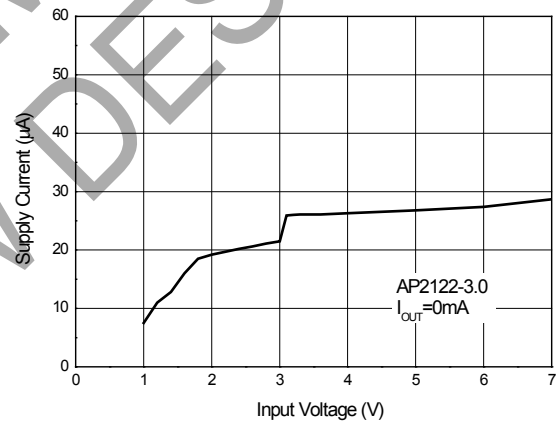

**Supply Current vs. Junction Temperature**

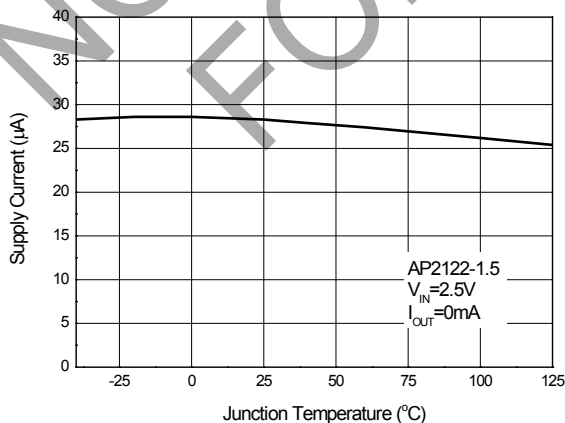

**Supply Current vs. Junction Temperature**

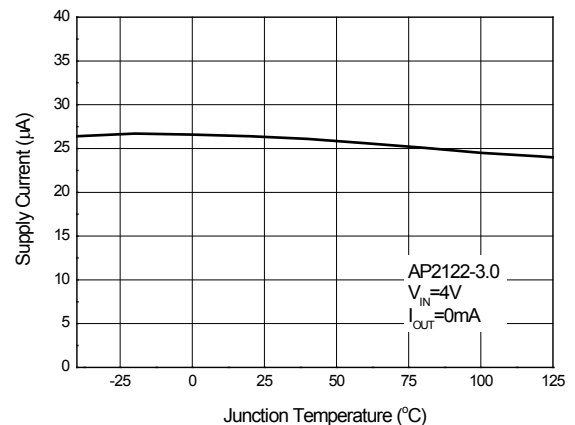

**Performance Characteristics (Cont.)**

**Line Transient**  
(Conditions:  $I_{OUT}=30\text{mA}$ ,  $C_{IN}=1\mu\text{F}$ ,  $C_{OUT}=1\mu\text{F}$ )

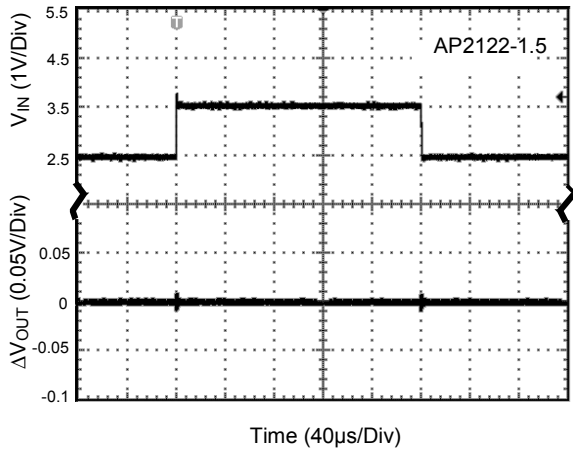

**Line Transient**  
(Conditions:  $I_{OUT}=30\text{mA}$ ,  $C_{IN}=1\mu\text{F}$ ,  $C_{OUT}=1\mu\text{F}$ )

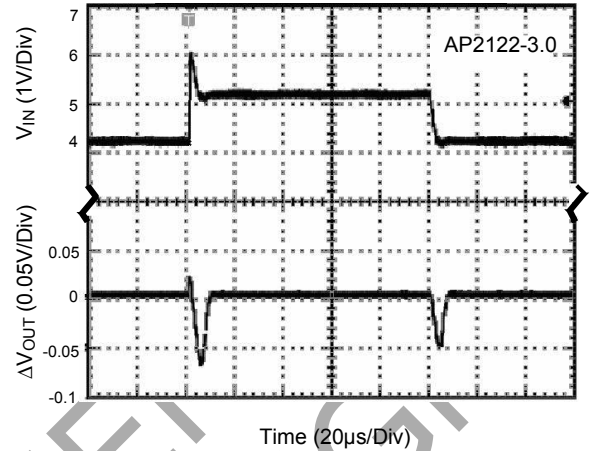

**Load Transient**  
(Conditions:  $V_{IN}=2.5\text{V}$ ,  $C_{IN}=1\mu\text{F}$ ,  $C_{OUT}=1\mu\text{F}$ )

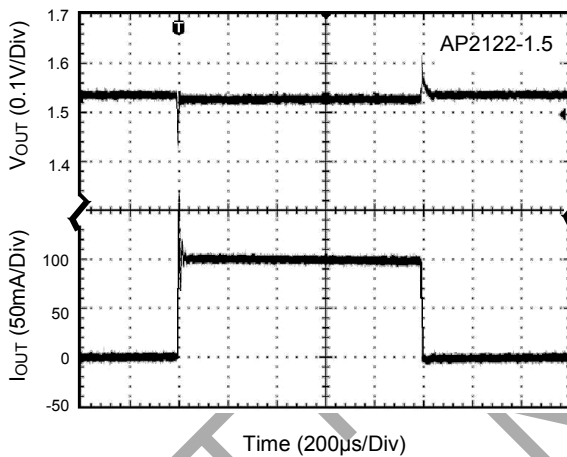

**Load Transient**  
(Conditions:  $V_{IN}=4\text{V}$ ,  $C_{IN}=1\mu\text{F}$ ,  $C_{OUT}=1\mu\text{F}$ )

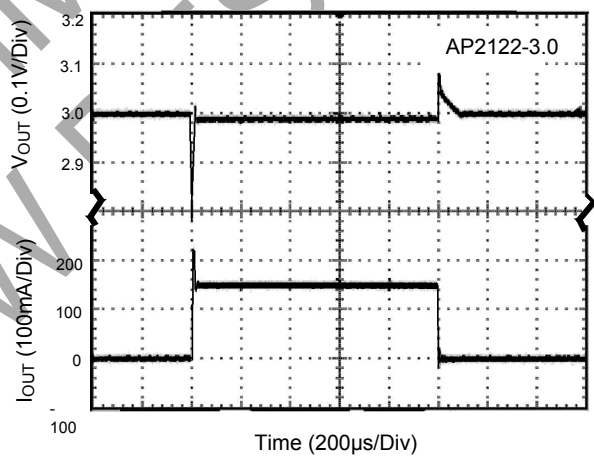

**PSRR vs. Frequency**

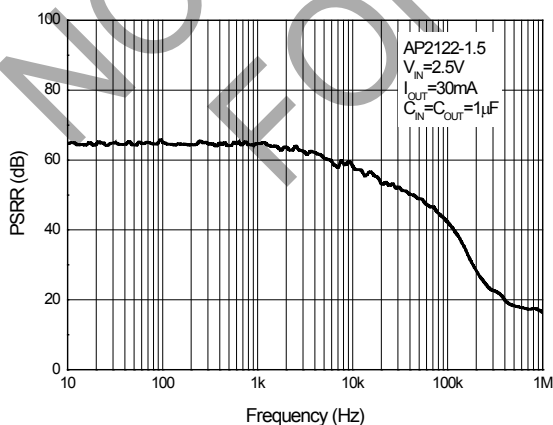

**PSRR vs. Frequency**

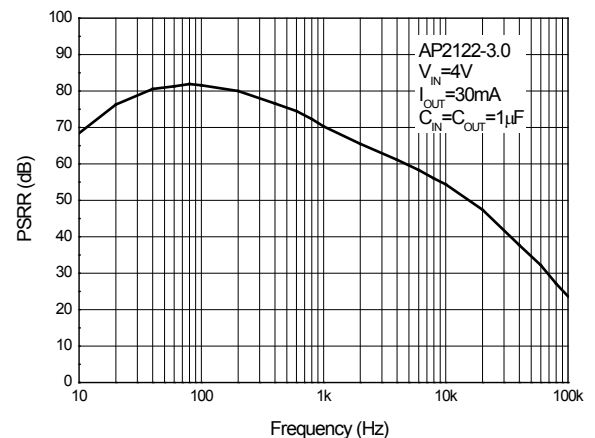

**Ordering Information**

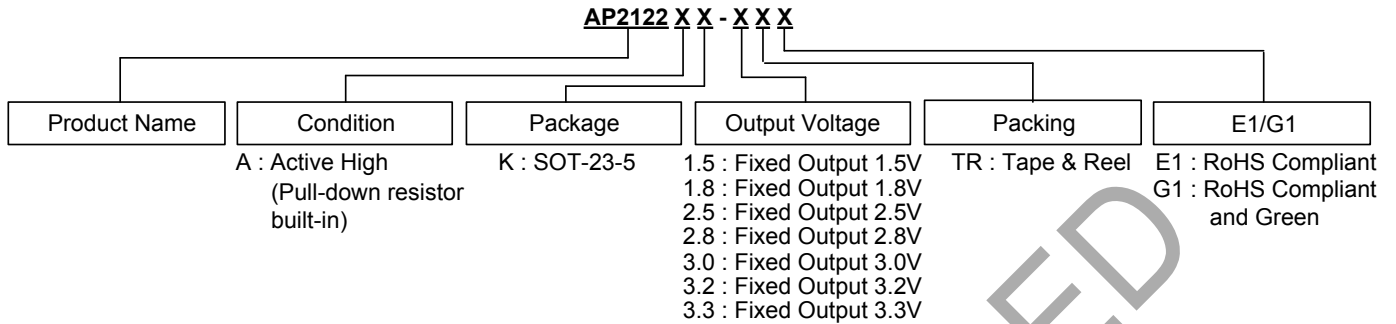

Package	Temperature Range	Condition	Part Number		Marking ID		Packing
			RoHS Compliant	RoHS Compliant and Green	RoHS Compliant	RoHS Compliant and Green	
SOT-23-5	-40 to +85°C	Active High (Pull-down resistor built-in)	AP2122AK-1.5TRE1	AP2122AK-1.5TRG1	E2Z	G2Z	Tape & Reel
		Active High (Pull-down resistor built-in)	AP2122AK-1.8TRE1	AP2122AK-1.8TRG1	E2U	G2U	Tape & Reel
		Active High (Pull-down resistor built-in)	AP2122AK-2.5TRE1	AP2122AK-2.5TRG1	E2V	G2V	Tape & Reel
		Active High (Pull-down resistor built-in)	AP2122AK-2.8TRE1	AP2122AK-2.8TRG1	E2W	G2W	Tape & Reel
		Active High (Pull-down resistor built-in)	AP2122AK-3.0TRE1	AP2122AK-3.0TRG1	E2X	G2X	Tape & Reel
		Active High (Pull-down resistor built-in)	AP2122AK-3.2TRE1	AP2122AK-3.2TRG1	E3Y	G3Y	Tape & Reel
		Active High (Pull-down resistor built-in)	AP2122AK-3.3TRE1	AP2122AK-3.3TRG1	E2Y	G2Y	Tape & Reel



**Suggested Pad Layout**

(1) Package Type: SOT-23-5

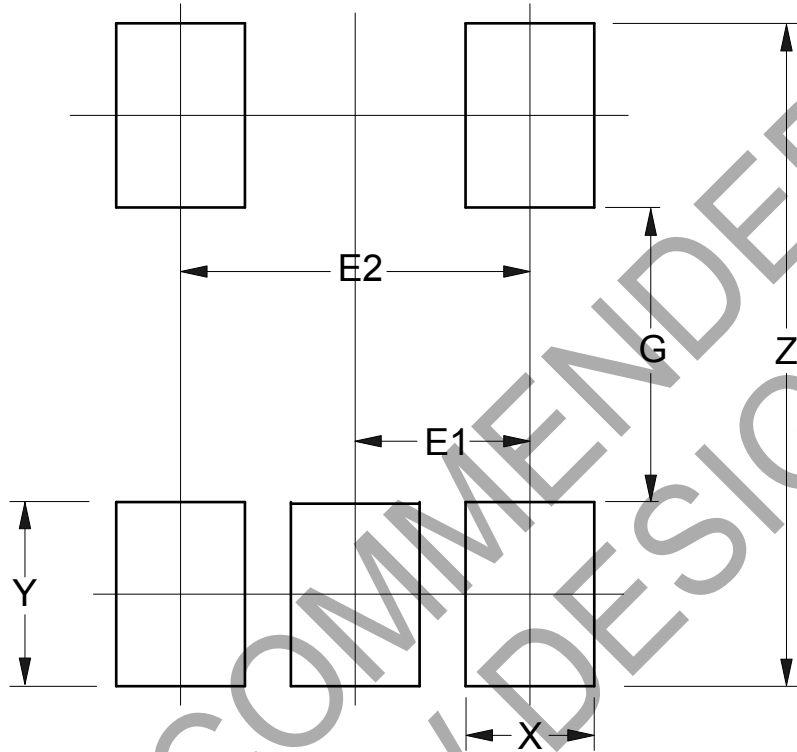

Dimensions	Z (mm)/(inch)	G (mm)/(inch)	X (mm)/(inch)	Y (mm)/(inch)	E1 (mm)/(inch)	E2 (mm)/(inch)
Value	3.600/0.142	1.600/0.063	0.700/0.028	1.000/0.039	0.950/0.037	1.900/0.075

**IMPORTANT NOTICE**

1. DIODES INCORPORATED AND ITS SUBSIDIARIES (“DIODES”) MAKE NO WARRANTY OF ANY KIND, EXPRESS OR IMPLIED, WITH REGARDS TO ANY INFORMATION CONTAINED IN THIS DOCUMENT, INCLUDING, BUT NOT LIMITED TO, THE IMPLIED WARRANTIES OF MERCHANTABILITY, FITNESS FOR A PARTICULAR PURPOSE OR NON-INFRINGEMENT OF THIRD PARTY INTELLECTUAL PROPERTY RIGHTS (AND THEIR EQUIVALENTS UNDER THE LAWS OF ANY JURISDICTION).
2. The Information contained herein is for informational purpose only and is provided only to illustrate the operation of Diodes products described herein and application examples. Diodes does not assume any liability arising out of the application or use of this document or any product described herein. This document is intended for skilled and technically trained engineering customers and users who design with Diodes products. Diodes products may be used to facilitate safety-related applications; however, in all instances customers and users are responsible for (a) selecting the appropriate Diodes products for their applications, (b) evaluating the suitability of the Diodes products for their intended applications, (c) ensuring their applications, which incorporate Diodes products, comply the applicable legal and regulatory requirements as well as safety and functional-safety related standards, and (d) ensuring they design with appropriate safeguards (including testing, validation, quality control techniques, redundancy, malfunction prevention, and appropriate treatment for aging degradation) to minimize the risks associated with their applications.
3. Diodes assumes no liability for any application-related information, support, assistance or feedback that may be provided by Diodes from time to time. Any customer or user of this document or products described herein will assume all risks and liabilities associated with such use, and will hold Diodes and all companies whose products are represented herein or on Diodes’ websites, harmless against all damages and liabilities.
4. Products described herein may be covered by one or more United States, international or foreign patents and pending patent applications. Product names and markings noted herein may also be covered by one or more United States, international or foreign trademarks and trademark applications. Diodes does not convey any license under any of its intellectual property rights or the rights of any third parties (including third parties whose products and services may be described in this document or on Diodes’ website) under this document.
5. Diodes products are provided subject to Diodes’ Standard Terms and Conditions of Sale (<https://www.diodes.com/about/company/terms-and-conditions/terms-and-conditions-of-sales/>) or other applicable terms. This document does not alter or expand the applicable warranties provided by Diodes. Diodes does not warrant or accept any liability whatsoever in respect of any products purchased through unauthorized sales channel.
6. Diodes products and technology may not be used for or incorporated into any products or systems whose manufacture, use or sale is prohibited under any applicable laws and regulations. Should customers or users use Diodes products in contravention of any applicable laws or regulations, or for any unintended or unauthorized application, customers and users will (a) be solely responsible for any damages, losses or penalties arising in connection therewith or as a result thereof, and (b) indemnify and hold Diodes and its representatives and agents harmless against any and all claims, damages, expenses, and attorney fees arising out of, directly or indirectly, any claim relating to any noncompliance with the applicable laws and regulations, as well as any unintended or unauthorized application.
7. While efforts have been made to ensure the information contained in this document is accurate, complete and current, it may contain technical inaccuracies, omissions and typographical errors. Diodes does not warrant that information contained in this document is error-free and Diodes is under no obligation to update or otherwise correct this information. Notwithstanding the foregoing, Diodes reserves the right to make modifications, enhancements, improvements, corrections or other changes without further notice to this document and any product described herein. This document is written in English but may be translated into multiple languages for reference. Only the English version of this document is the final and determinative format released by Diodes.
8. Any unauthorized copying, modification, distribution, transmission, display or other use of this document (or any portion hereof) is prohibited. Diodes assumes no responsibility for any losses incurred by the customers or users or any third parties arising from any such unauthorized use.

Copyright © 2020 Diodes Incorporated

[www.diodes.com](http://www.diodes.com)

## Looking for pricing, stock, or lifecycle information?

Click below to explore more details on WIN SOURCE:

 [View AP2122AK-3.0TRG1 on WIN SOURCE](#)

 [Diodes Incorporated](#) Information

## Optimize Your Supply Chain with WIN SOURCE Solutions

-  Global Sourcing Solution
-  Obsolete Management
-  Cost Control Management
-  Shortage Management
-  Alternative Solution
-  Excess Inventory Management