



THE DATASHEET OF
AP7365-25EG-13



**600mA, LOW QUIESCENT CURRENT
FAST TRANSIENT LOW DROPOUT LINEAR REGULATOR**

Description

The AP7365 is a 600mA, adjustable and fixed output voltage, low dropout linear regulator. This device includes pass element, error amplifier, band-gap, current limit and thermal shutdown circuitry. The device is turned on when EN pin is set to logic high level.

The characteristics of low dropout voltage and low quiescent current make it suitable for low power applications such as battery powered devices. The typical quiescent current is approximately 35µA. Built-in current-limit and thermal-shutdown functions prevent IC from damage in fault conditions.

This device is available with adjustable output from 0.8V to 5.0V, and fixed version with 0.8V, 1.0V, 1.2V, 1.5V, 1.8V, 2.0V, 2.5V, 2.8V, 3.0V, 3.3V and 3.9V outputs. Please contact your local sales office for other voltage options.

The AP7365 is available in SOT25, SOT89, SOT223, and U-DFN2020-6 packages.

Features

- 600mA Low Dropout Regulator with EN
- Very Low I_q: 35µA
- Wide Input Voltage Range: 2V to 6V
- Wide Adjustable Output: 0.8V to 5.0V
- Fixed Output Options: 0.8V to 3.9V (0.1V Step Size Possible)
- High PSRR: 65dB at 1kHz
- Fast Start-Up Time: 200µs
- Stable with Low ESR, 1µF Ceramic Output Capacitor
- Excellent Load/Line Transient Response
- Low Dropout: 300mV at 600mA
- Current Limit and Short Circuit Protection
- Thermal Shutdown Protection
- Ambient Temperature Range: -40°C to +85°C
- **Totally Lead-Free & Fully RoHS Compliant (Notes 1 & 2)**
- **Halogen and Antimony Free. "Green" Device (Note 3)**
- **For automotive applications requiring specific change control (i.e. parts qualified to AEC-Q100/101/200, PPAP capable, and manufactured in IATF 16949 certified facilities), please [contact us](mailto:contact@diodes.com) or your local Diodes representative. <https://www.diodes.com/quality/product-definitions/>**

Applications

- Servers and Notebook Computers
- Low and Medium Power Applications
- FPGA and DSP Core or I/O Power
- Consumer Electronics

Pin Assignments

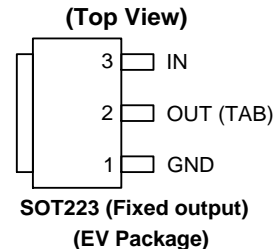
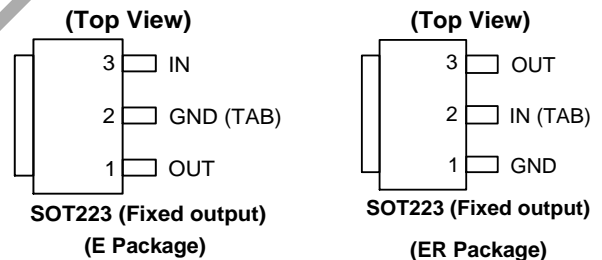
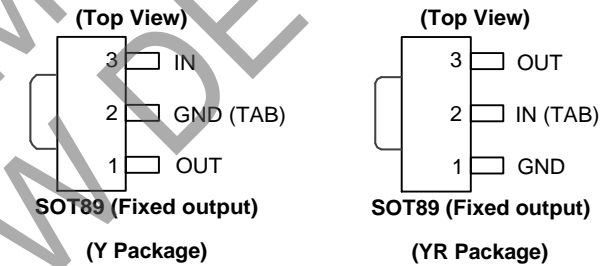
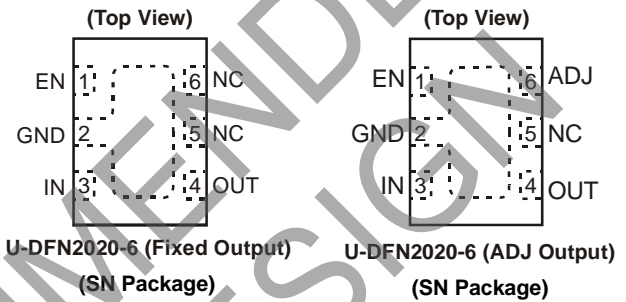
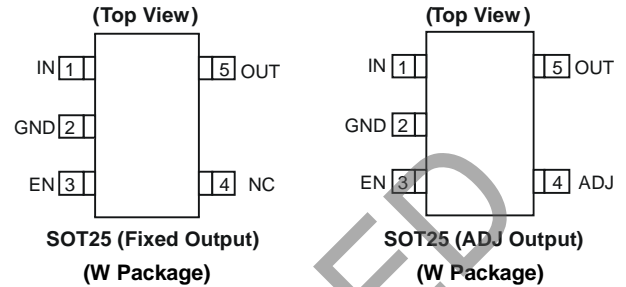

Notes: 1. No purposely added lead. Fully EU Directive 2002/95/EC (RoHS), 2011/65/EU (RoHS 2) & 2015/863/EU (RoHS 3) compliant.
2. See <https://www.diodes.com/quality/lead-free/> for more information about Diodes Incorporated's definitions of Halogen- and Antimony-free, "Green" and Lead-free.
3. Halogen- and Antimony-free "Green" products are defined as those which contain <900ppm bromine, <900ppm chlorine (<1500ppm total Br + Cl) and <1000ppm antimony compounds.

Typical Applications Circuit

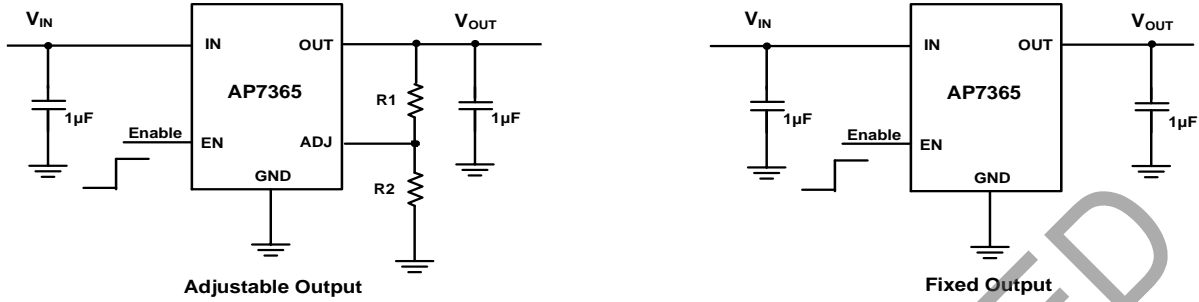

$$V_{OUT} = V_{REF} \left(1 + \frac{R_1}{R_2} \right) \text{ where } R_2 \leq 80K\Omega$$

Pin Descriptions

Pin Name	Pin Number							Functions
	SOT25 (Fixed)	SOT25 (ADJ)	U-DFN2020-6 (Fixed)	U-DFN2020-6 (ADJ)	SOT89 (Y Package) SOT223 (E Package)	SOT89 (YR Package) SOT223 (ER Package)	SOT223 (EV Package)	
IN	1	1	3	3	3	2	3	Voltage Input Pin. Bypass to ground through at least 1µF MLCC capacitor
GND	2	2	2	2	2	1	1	Ground
EN	3	3	1	1	—	—	—	Enable Input, Active High
ADJ	—	4	—	6	—	—	—	Output Feedback Pin
NC	4	—	5, 6	5	—	—	—	No Connection
OUT	5	5	4	4	1	3	2	Voltage Output Pin. Bypass to ground through 1µF MLCC capacitor

Functional Block Diagram

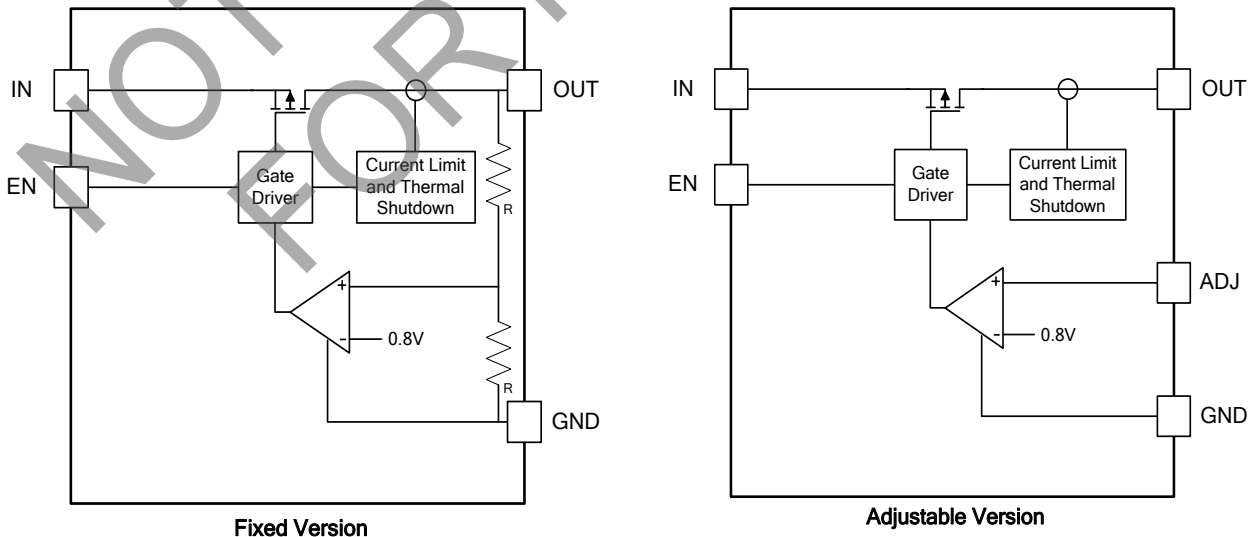

Absolute Maximum Ratings (@T_A = +25°C, unless otherwise specified.)

Symbol	Parameter	Ratings	Unit
ESD HBM	Human Body Model ESD Protection	2000	V
ESD MM	Machine Model ESD Protection	200	V
V _{IN}	Input Voltage	6.5	V
—	OUT, EN Voltage	V _{IN} +0.3	V
—	Continuous Load Current per Channel	Internal Limited	—
T _{ST}	Storage Temperature Range	-65 to +150	°C
T _J	Maximum Junction Temperature	+150	°C

Recommended Operating Conditions (@T_A = +25°C, unless otherwise specified.)

Symbol	Parameter	Min	Max	Unit
V _{IN}	Input Voltage	2	6	V
I _{OUT}	Output Current (Note 4)	0	600	mA
T _A	Operating Ambient Temperature	-40	+85	°C

Note: 4. The device maintains a stable, regulated output voltage without a load current.

Electrical Characteristics (@T_A = +25°C, V_{IN} = V_{OUT} +1V, C_{OUT} = 1μF, C_{IN} = 1μF, V_{EN} = 2V, unless otherwise specified.)

Symbol	Parameter	Test Conditions	Min	Typ	Max	Unit
V _{REF}	ADJ Reference Voltage (Adjustable Version)	I _{OUT} = 0mA	—	0.8	—	V
I _{ADJ}	ADJ Leakage (Adjustable Version)	—	—	0.1	1.0	μA
V _{OUT}	Output Voltage Accuracy	T _A = -40°C to +85°C, I _{OUT} = 10% of I _{OUT-Max}	-2	—	+2	%
$\frac{\Delta V_{OUT}}{\Delta V_{IN}/V}$	Line Regulation	V _{IN} = (V _{OUT} +1V) to V _{IN-Max} , V _{EN} = V _{IN} , I _{OUT} = 1mA	—	0.02	0.20	%/V
$\Delta V_{OUT}/V_{OUT}$	Load Regulation	V _{IN} = (V _{OUT} +1V) to V _{IN-Max} , I _{OUT} = 1mA to 600mA	-1.0	—	+1.0	%
V _{DROPOUT}	Dropout Voltage (Note 5)	V _{OUT} < 2.5V, I _{OUT} = 600mA V _{OUT} ≥ 2.5V, I _{OUT} = 600mA	—	370 300	600 400	mV
I _Q	Input Quiescent Current	V _{EN} = V _{IN} , I _{OUT} = 0mA	—	35	80	μA
I _{SHDN}	Input Shutdown Current	V _{EN} = 0V, I _{OUT} = 0mA	—	0.1	1.0	μA
I _{LEAK}	Input Leakage Current	V _{EN} = 0V, OUT grounded	—	0.1	1.0	μA
t _{ST}	Start-Up Time	V _{EN} = 0V to 2.0V in 1μs, I _{OUT} = 600mA	—	200	—	μs
PSRR	PSRR (Note 6)	V _{IN} = [V _{OUT} +1V] V _{DC} + 0.5V _{ppAC} , f = 1kHz, I _{OUT} = 50mA	—	65	—	dB
I _{SHORT}	Short-Circuit Current	V _{IN} = V _{IN-Min} to V _{IN-Max} , V _{OUT} < 0.2V (fixed version) or 25% of V _{OUT} (ADJ version)	—	240	—	mA
I _{LIMIT}	Current limit	V _{IN} = V _{IN-Min} to V _{IN-Max} , V _{OUT} /R _{OUT} = 2.5A	0.8	1.4	—	A
V _{IL}	EN Input Logic Low Voltage	V _{IN} = V _{IN-Min} to V _{IN-Max}	—	—	0.4	V
V _{IH}	EN Input Logic High Voltage	V _{IN} = V _{IN-Min} to V _{IN-Max}	1.4	—	—	V
I _{EN}	EN Input Current	V _{IN} = 0V or V _{IN-Max}	-1	—	+1	μA
T _{SHDN}	Thermal Shutdown Threshold	—	—	+145	—	°C
T _{HYS}	Thermal Shutdown Hysteresis	—	—	+15	—	°C

Notes: 5. Dropout voltage is the voltage difference between the input and the output at which the output voltage drops 2% below its nominal value. This parameter only applies to input voltages above minimum V_{IN} = 2.0V.

6. At V_{IN} < 2.3V, the PSRR performance may be reduced.

Electrical Characteristics (continued) (@ $T_A = +25^\circ\text{C}$, $V_{IN} = V_{OUT} + 1\text{V}$, $C_{OUT} = 1\mu\text{F}$, $C_{IN} = 1\mu\text{F}$, $V_{EN} = 2\text{V}$, unless otherwise specified.)

Symbol	Parameter	Test Conditions	Min	Typ	Max	Unit
θ_{JA}	Thermal Resistance Junction-to-Ambient	SOT25 (Note 7)	—	169	—	$^\circ\text{C/W}$
		U-DFN2020-6 (Note 7)	—	132	—	
		SOT89 (Note 7)	—	133	—	
		SOT223 (Note 7)	—	142	—	
θ_{JC}	Thermal Resistance Junction-to-Case	SOT25 (Note 7)	—	31	—	$^\circ\text{C/W}$
		U-DFN2020-6 (Note 7)	—	48	—	
		SOT89 (Note 7)	—	30	—	
		SOT223 (Note 7)	—	39	—	

Note: 7. Test condition for all packages: Device mounted on FR-4 substrate PC board, 1oz copper, with minimum recommended pad layout.

Typical Performance Characteristics

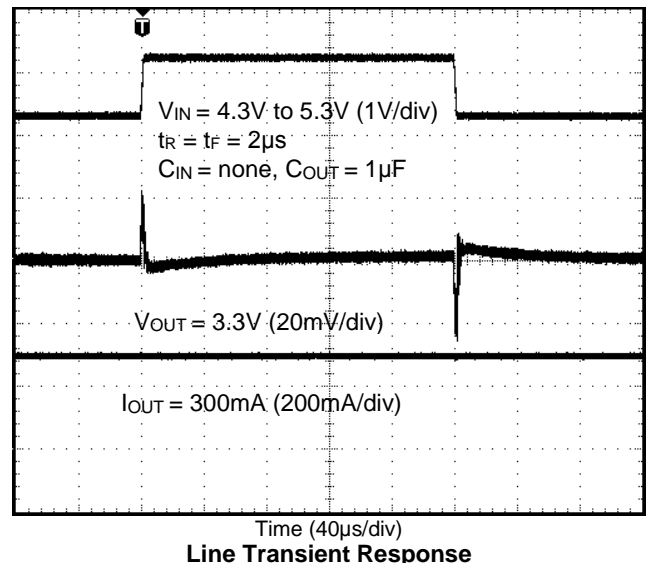
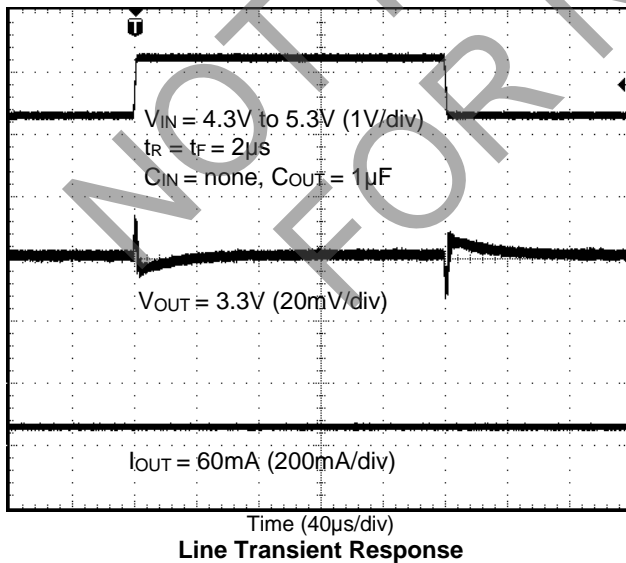
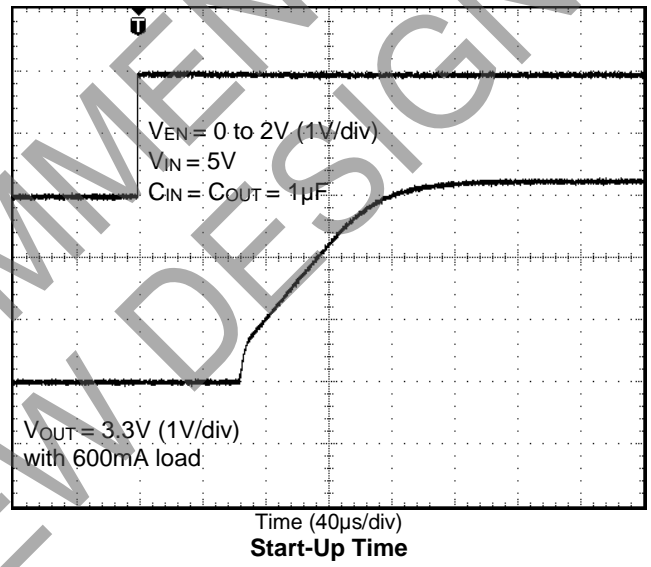
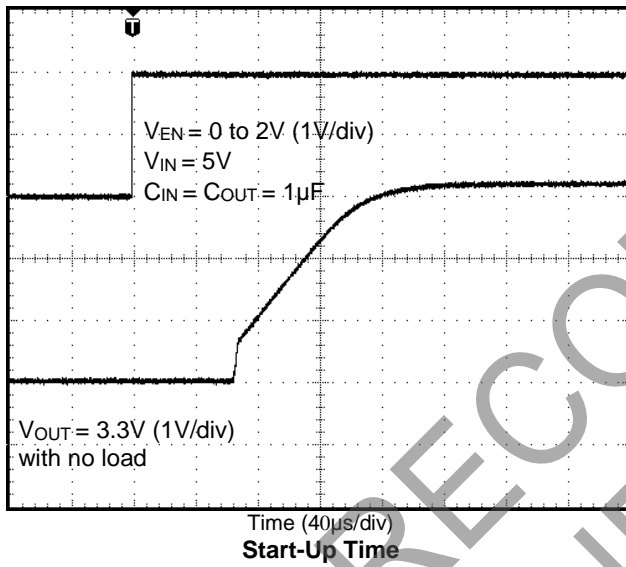

Typical Performance Characteristics (continued)

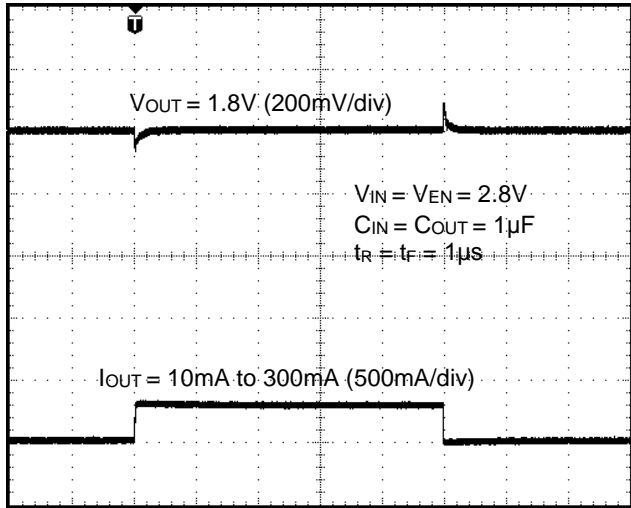

Load Transient Response
Time (100µs/div)

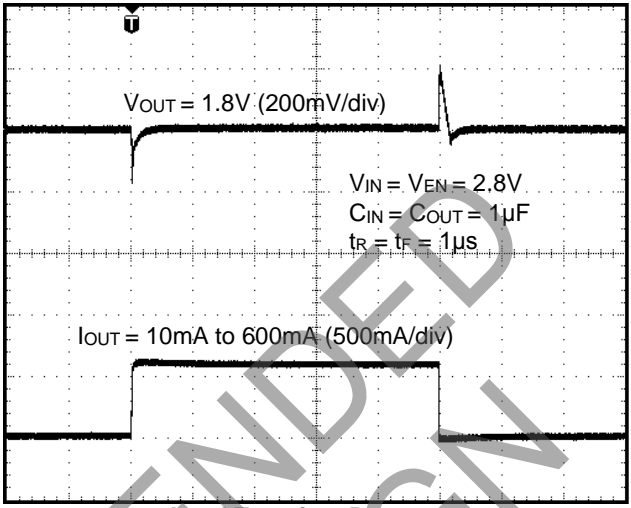

Load Transient Response
Time (100µs/div)

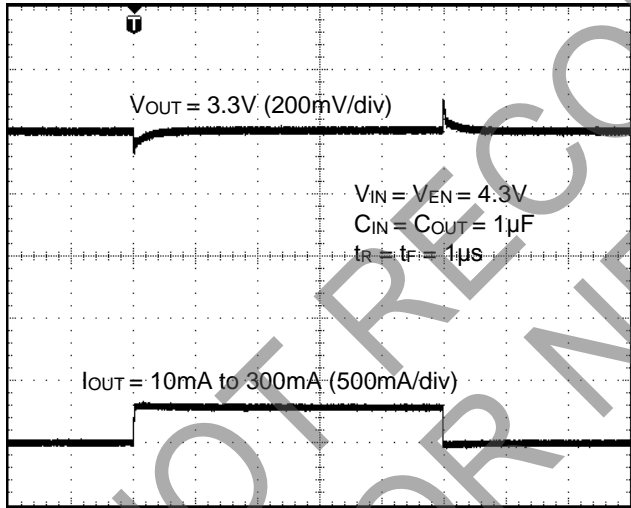

Load Transient Response
Time (100µs/div)

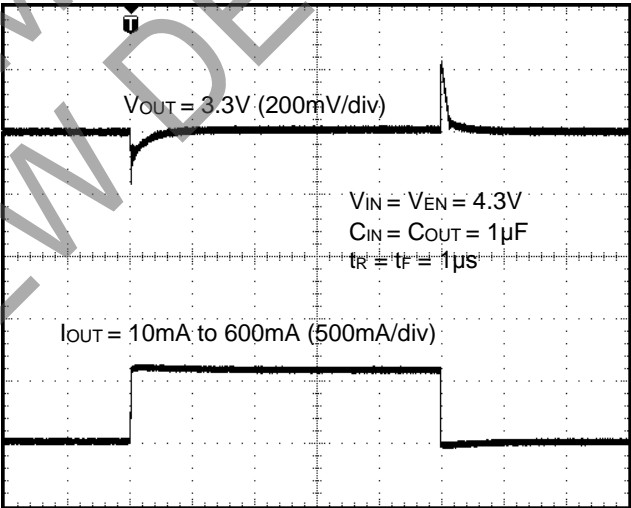

Load Transient Response
Time (100µs/div)

Typical Performance Characteristics (continued)

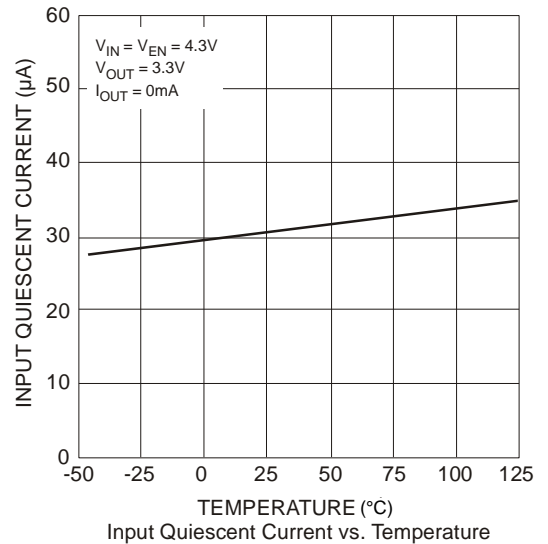
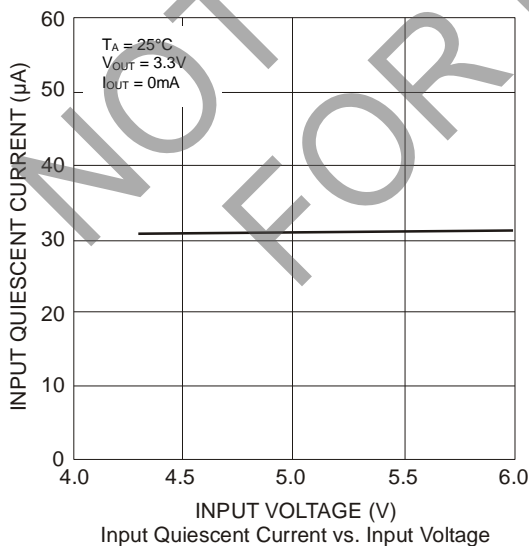
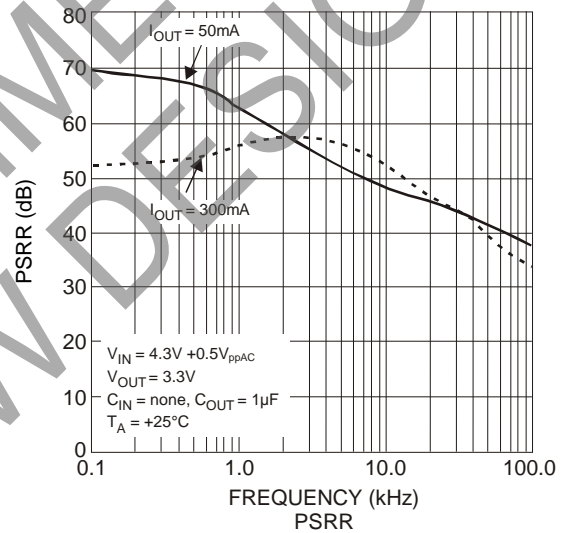
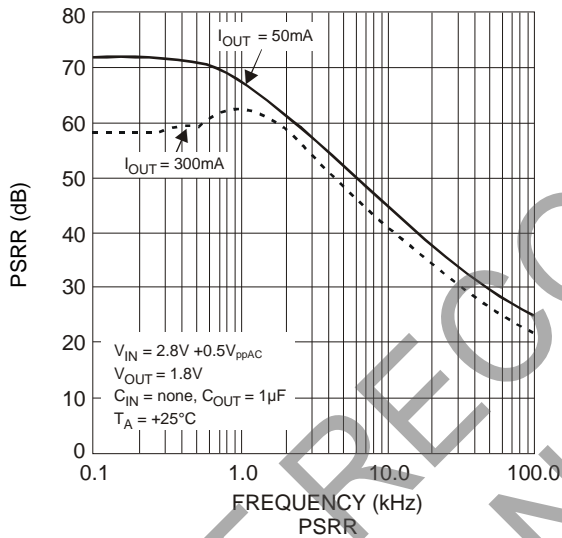
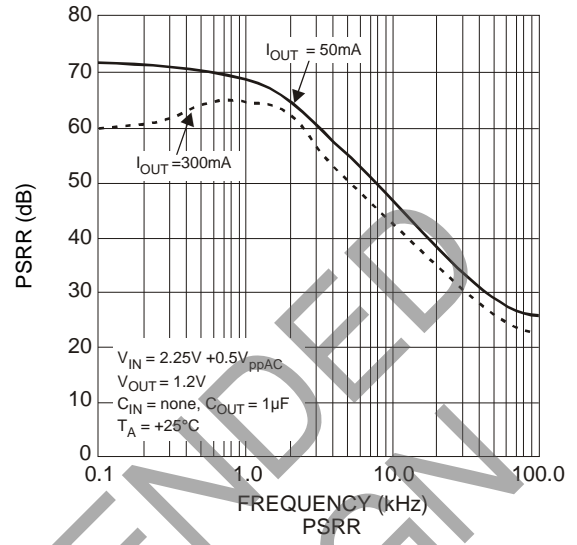
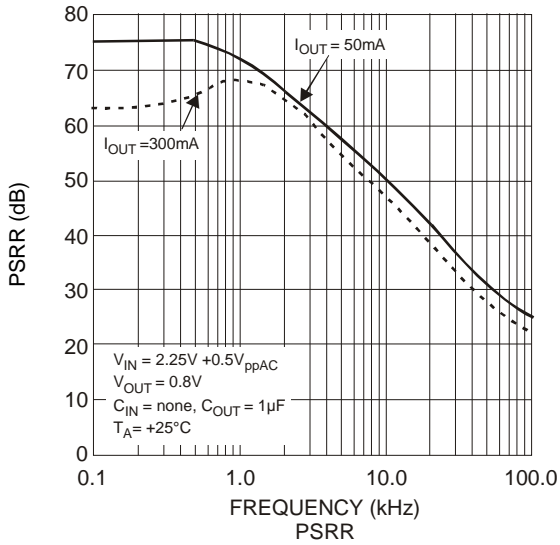

Typical Performance Characteristics (continued)

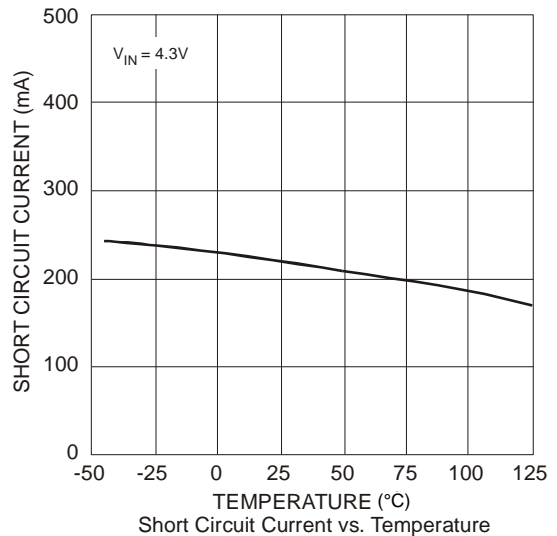
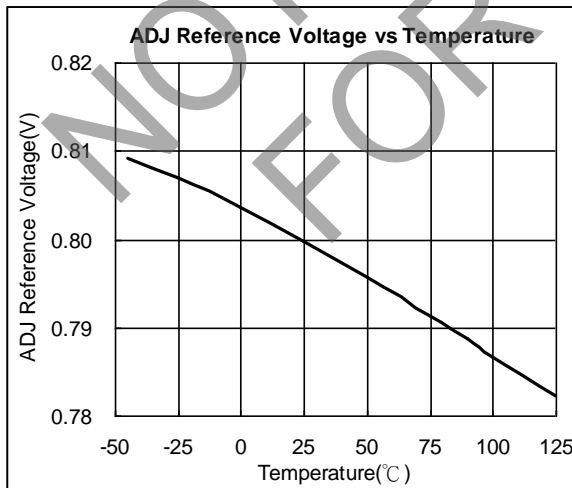
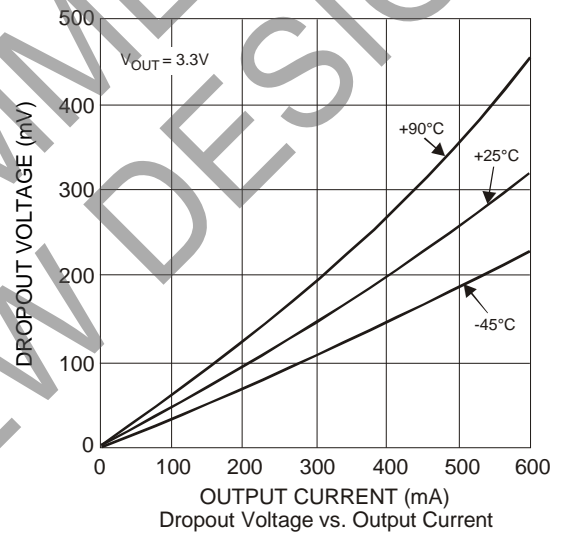
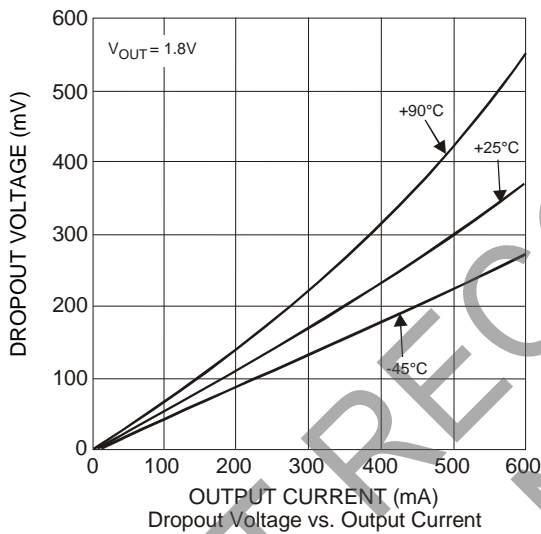
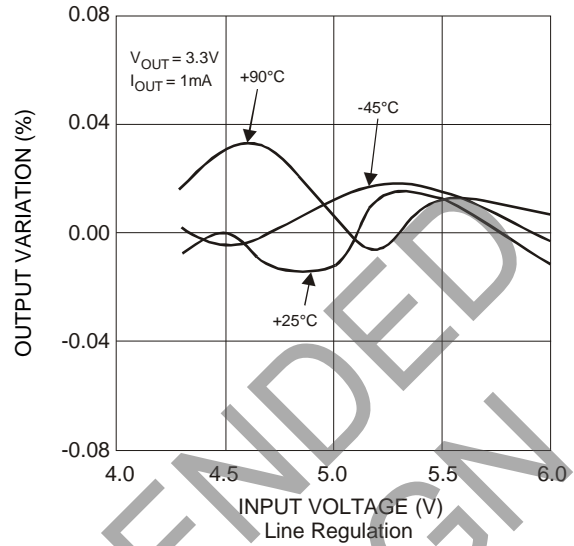
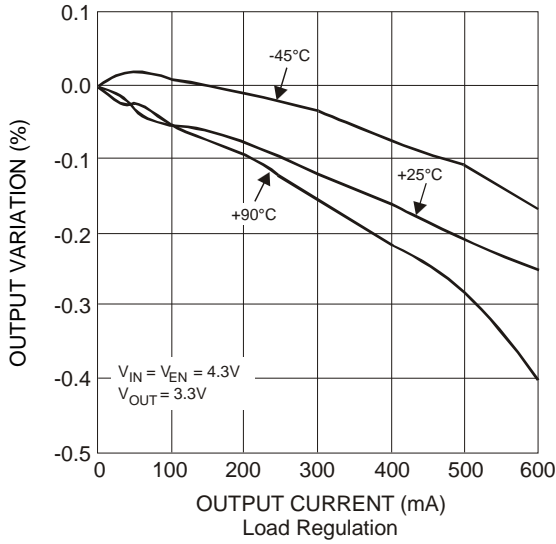

Typical Performance Characteristics (continued)

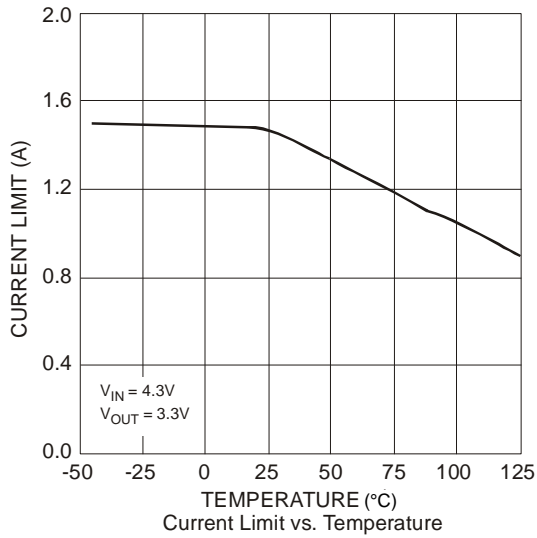

Application Information

Input Capacitor

A 1µF ceramic capacitor is recommended between IN and GND pins to decouple input power supply glitch and noise. The amount of the capacitance may be increased without limit. This input capacitor must be located as close as possible to the device to assure input stability and reduce noise. For PCB layout, a wide copper trace is required for both IN and GND pins. A lower ESR capacitor type allows the use of less capacitance, while higher ESR type requires more capacitance.

Output Capacitor

The output capacitor is required to stabilize and improve the transient response of the LDO. The AP7365 is stable with very small ceramic output capacitors. Using a ceramic capacitor value that is at least 1µF with ESR > 15mΩ on the output ensures stability. Higher capacitance values help to improve line and load transient response. The output capacitance may be increased to keep low undershoot and overshoot. Output capacitor must be placed as close as possible to OUT and GND pins.

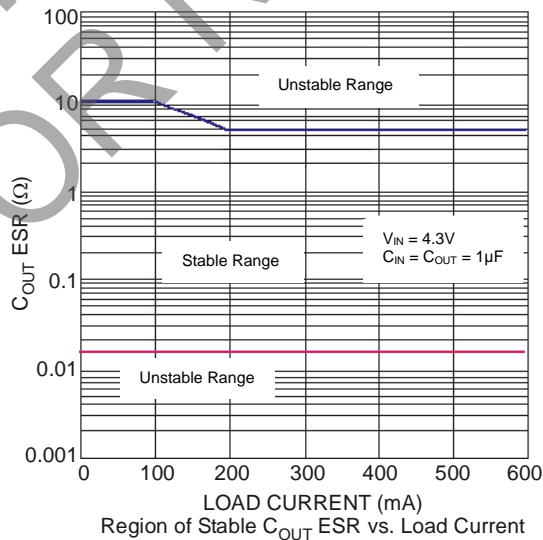

Application Information (continued)

Adjustable Operation

The AP7365 provides output voltage from 0.8V to 5.0V through external resistor divider as shown below.

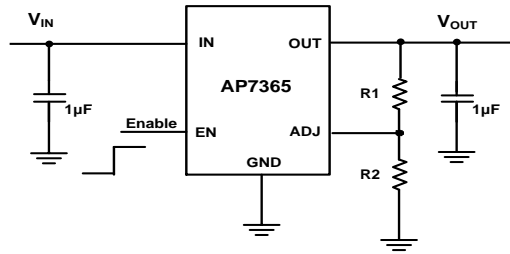

The output voltage is calculated by:

$$V_{OUT} = V_{REF} \left(1 + \frac{R_1}{R_2} \right)$$

Where $V_{REF} = 0.8V$ (the internal reference voltage)

Rearranging the equation will give the following that is used for adjusting the output to a particular voltage:

$$R_1 = R_2 \left(\frac{V_{OUT}}{V_{REF}} - 1 \right)$$

To maintain the stability of the internal reference voltage, R_2 needs to be kept smaller than 80kΩ.

No Load Stability

Other than external resistor divider, no minimum load is required to keep the device stable. The device will remain stable and regulated in no load condition.

ON/OFF Input Operation

The AP7365 is turned on by setting the EN pin high, and is turned off by pulling it low. If this feature is not used, the EN pin should be tied to IN pin to keep the regulator output on at all time. To ensure proper operation, the signal source used to drive the EN pin must be able to swing above and below the specified turn-on/off voltage thresholds listed in the Electrical Characteristics section under V_{IL} and V_{IH} .

Current Limit Protection

When output current at OUT pin is higher than current limit threshold, the current limit protection will be triggered and clamp the output current to approximately 1.4A to prevent overcurrent and to protect the regulator from damage due to overheating.

Short Circuit Protection

When OUT pin is short-circuit to GND, short circuit protection will be triggered and clamp the output current to approximately 240mA. This feature protects the regulator from overcurrent and damage due to overheating.

Thermal Shutdown Protection

Thermal protection disables the output when the junction temperature rises to approximately +145°C, allowing the device to cool down. When the junction temperature reduces to approximately +130°C, the output circuitry is enabled again. Depending on power dissipation, thermal resistance and ambient temperature, the thermal protection circuit may cycle on and off. This cycling limits the heat dissipation of the regulator, protecting it from damage due to overheating.

Ultra Fast Start-Up

After enabled, the AP7365 is able to provide full power in as little as hundreds of microseconds, typically 200µs, without sacrificing low ground current. This feature will help load circuitry move in and out of standby mode in real time, eventually extend battery life for mobile phones and other portable devices.

Application Information (continued)

Fast Transient Response

Fast transient response LDO can extend battery life. TDMA-based cell phone protocols such as Global System for Mobile Communications (GSM) have a transmit/receive duty factor of only 12.5%, enabling power savings by putting much of the baseband circuitry into standby mode in between transmit cycles. In baseband circuits, the load often transitions virtually instantaneously from 100µA to 100mA. To meet this load requirement, the LDO must react very quickly without a large voltage drop or overshoot — a requirement that cannot be met with conventional, general-purpose LDO.

The AP7365's fast transient response from 0 to 600mA provides stable voltage supply for fast DSP and GSM chipset with fast changing load.

Low Quiescent Current

The AP7365, consuming only around 35µA for all input ranges, provides great power saving in portable and low power applications.

Wide Output Range

The AP7365, with a wide output range of 0.8V to 5.0V, provides a versatile LDO solution for many portable applications.

Power Dissipation

The device power dissipation and proper sizing of the thermal plane connected to the thermal pad is critical to avoid thermal shutdown and ensure reliable operation. Power dissipation of the device depends on input voltage and load conditions and can be calculated by:

$$P_D = (V_{IN} - V_{OUT}) \times I_{OUT}$$

The maximum power dissipation, handled by the device, depends on the maximum junction to ambient thermal resistance, maximum ambient temperature, and maximum device junction temperature, which can be calculated by the equation in the following:

$$P_D(MAX@T_A) = \frac{(+145^{\circ}C - T_A)}{R_{\theta JA}}$$

Ordering Information

AP7365 - **XX XX G - X**

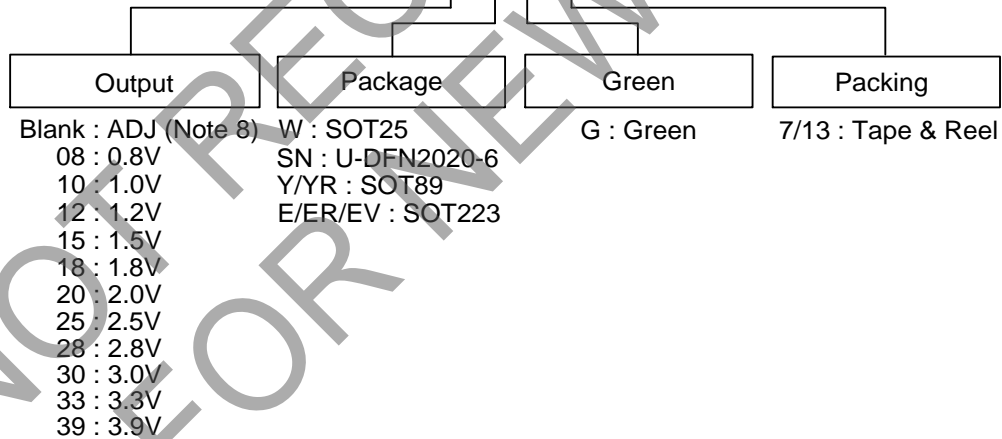

Part Number	Package Code	Packaging	7"/13" Tape and Reel	
			Quantity	Part Number Suffix
AP7365-XXWG-7	W	SOT25	3,000/Tape & Reel	-7
AP7365-XXSNG-7	SN	U-DFN2020-6	3,000/Tape & Reel	-7
AP7365-XXYG-13	Y	SOT89	2,500/Tape & Reel	-13
AP7365-XXYRG-13	YR	SOT89	2,500/Tape & Reel	-13
AP7365-XXEG-13	E	SOT223	2,500/Tape & Reel	-13
AP7365-XXERG-13	ER	SOT223	2,500/Tape & Reel	-13
AP7365-XXEVG-13	EV	SOT223	2,500/Tape & Reel	-13

Note: 8. Adjustable version is only available in SOT25 and U-DFN2020-6 packages.

Marking Information

(1) SOT25

(Top View)

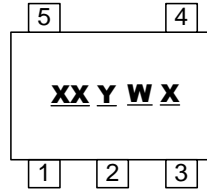

XX : Identification code
Y : Year 0~9
W : Week : A~Z : 1~26 week;
a~z : 27~52 week; z represents
52 and 53 week
X : A~Z : Green

Part Number	Package	Identification Code
AP7365-WG-7	SOT25	VA
AP7365-08WG-7	SOT25	VB
AP7365-10WG-7	SOT25	VC
AP7365-12WG-7	SOT25	VD
AP7365-15WG-7	SOT25	VE
AP7365-18WG-7	SOT25	VF
AP7365-20WG-7	SOT25	VG
AP7365-25WG-7	SOT25	VH
AP7365-28WG-7	SOT25	VJ
AP7365-30WG-7	SOT25	VK
AP7365-33WG-7	SOT25	VM
AP7365-39WG-7	SOT25	VN

(2) U-DFN2020-6

(Top View)

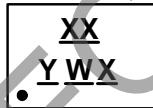

XX : Identification Code
Y : Year : 0~9
W : Week : A~Z : 1~26 week;
a~z : 27~52 week; z represents
52 and 53 week
X : A~Z : Green

Part Number	Package	Identification Code
AP7365-SNG-7	U-DFN2020-6	VA
AP7365-08SNG-7	U-DFN2020-6	VB
AP7365-10SNG-7	U-DFN2020-6	VC
AP7365-12SNG-7	U-DFN2020-6	VD
AP7365-15SNG-7	U-DFN2020-6	VE
AP7365-18SNG-7	U-DFN2020-6	VF
AP7365-20SNG-7	U-DFN2020-6	VG
AP7365-25SNG-7	U-DFN2020-6	VH
AP7365-28SNG-7	U-DFN2020-6	VJ
AP7365-30SNG-7	U-DFN2020-6	VK
AP7365-33SNG-7	U-DFN2020-6	VM
AP7365-39SNG-7	U-DFN2020-6	VN

Marking Information (continued)

(3) SOT89

(Top View)

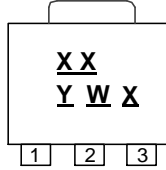

XX : Identification code
Y : Year : 0~9
W : Week : A~Z : 1~26 week;
a~z : 27~52 week;
z represents 52 and 53 week
X : Internal code
A~Z : Green

Part Number	Package	Identification Code
AP7365-08YG-13	SOT89	VB
AP7365-10YG-13	SOT89	VC
AP7365-12YG-13	SOT89	VD
AP7365-15YG-13	SOT89	VE
AP7365-18YG-13	SOT89	VF
AP7365-20YG-13	SOT89	VG
AP7365-25YG-13	SOT89	VH
AP7365-28YG-13	SOT89	VJ
AP7365-30YG-13	SOT89	VK
AP7365-33YG-13	SOT89	VM
AP7365-39YG-13	SOT89	VN
AP7365-08YRG-13	SOT89	TB
AP7365-10YRG-13	SOT89	TC
AP7365-12YRG-13	SOT89	TD
AP7365-15YRG-13	SOT89	TE
AP7365-18YRG-13	SOT89	TF
AP7365-20YRG-13	SOT89	TG
AP7365-25YRG-13	SOT89	TH
AP7365-28YRG-13	SOT89	TJ
AP7365-30YRG-13	SOT89	TK
AP7365-33YRG-13	SOT89	TM
AP7365-39YRG-13	SOT89	TN

(4) SOT223 (E Package)

(Top View)

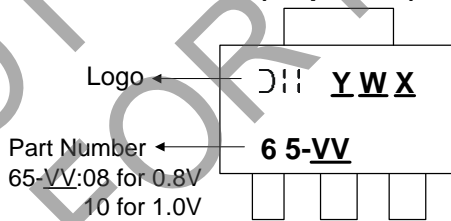

Y : Year : 0~9
W : Week : A~Z : 1~26 week;
a~z : 27~52 week;
z represents 52 and 53 week
X : Internal code
A~Z : Green

Part Number ←
65-VV:08 for 0.8V
10 for 1.0V
12 for 1.2V
15 for 1.5V
18 for 1.8V
20 for 2.0V
25 for 2.5V
28 for 2.8V
30 for 3.0V
33 for 3.3V
39 for 3.9V

Marking Information (continued)

(5) SOT223 (ER Package)

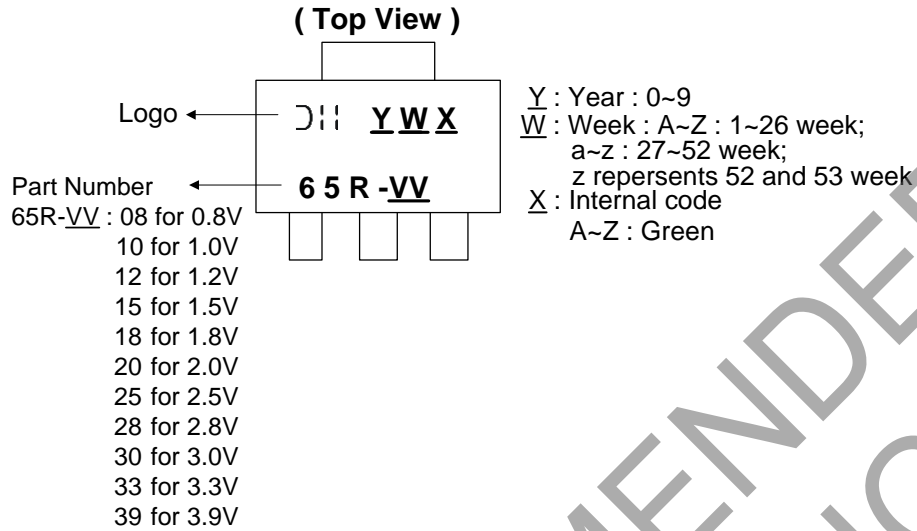

(6) SOT223 (EV Package)

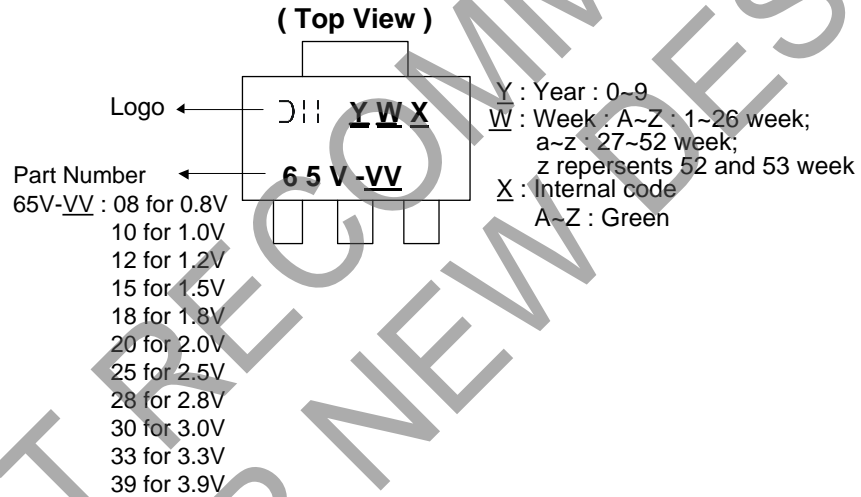

Package Outline Dimensions

Please see <http://www.diodes.com/package-outlines.html> for the latest version.

(1) Package Type: SOT25

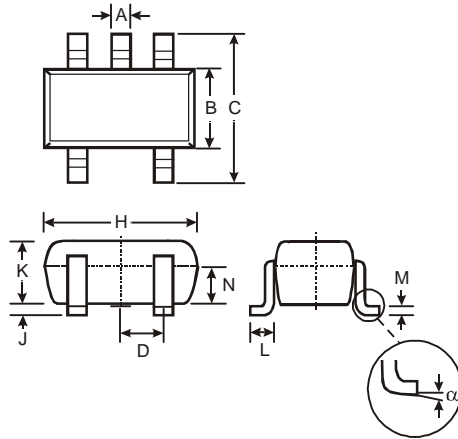

SOT25			
Dim	Min	Max	Typ
A	0.35	0.50	0.38
B	1.50	1.70	1.60
C	2.70	3.00	2.80
D	—	—	0.95
H	2.90	3.10	3.00
J	0.013	0.10	0.05
K	1.00	1.30	1.10
L	0.35	0.55	0.40
M	0.10	0.20	0.15
N	0.70	0.80	0.75
α	0°	8°	—
All Dimensions in mm			

(2) Package Type: U-DFN2020-6

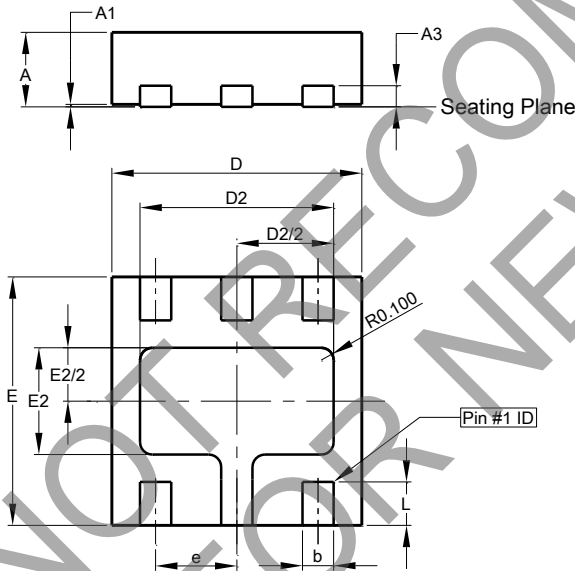

U-DFN2020-6			
Dim	Min	Max	Typ
A	0.57	0.63	0.60
A1	0	0.05	0.03
A3	-	-	0.15
b	0.20	0.30	0.25
D	1.95	2.075	2.00
D2	1.45	1.65	1.55
e	-	-	0.65
E	1.95	2.075	2.00
E2	0.76	0.96	0.86
L	0.30	0.40	0.35
All Dimensions in mm			

Package Outline Dimensions (continued)

Please see <http://www.diodes.com/package-outlines.html> for the latest version.

(3) Package Type: SOT89

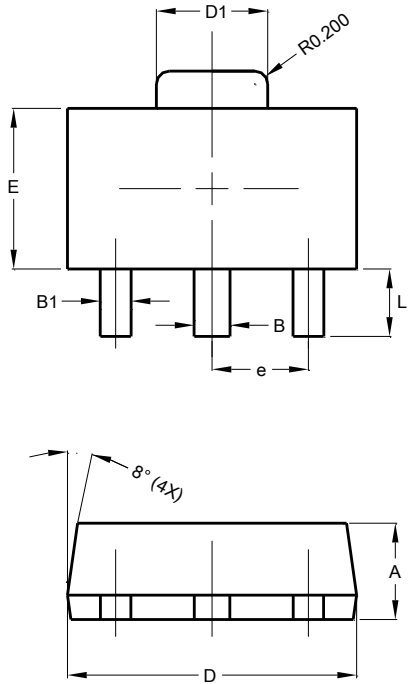

SOT89			
Dim	Min	Max	Typ
A	1.40	1.60	1.50
B	0.50	0.62	0.56
B1	0.42	0.54	0.48
c	0.35	0.43	0.38
D	4.40	4.60	4.50
D1	1.62	1.83	1.733
D2	1.61	1.81	1.71
E	2.40	2.60	2.50
E2	2.05	2.35	2.20
e	-	-	1.50
H	3.95	4.25	4.10
H1	2.63	2.93	2.78
L	0.90	1.20	1.05
L1	0.327	0.527	0.427
z	0.20	0.40	0.30

All Dimensions in mm

(4) Package Type: SOT223

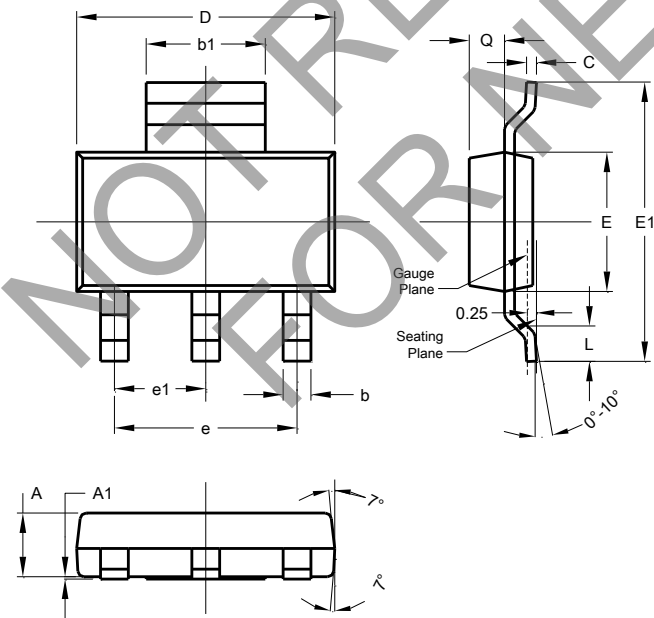

SOT223			
Dim	Min	Max	Typ
A	1.55	1.65	1.60
A1	0.010	0.15	0.05
b	0.60	0.80	0.70
b1	2.90	3.10	3.00
C	0.20	0.30	0.25
D	6.45	6.55	6.50
E	3.45	3.55	3.50
E1	6.90	7.10	7.00
e	-	-	4.60
e1	-	-	2.30
L	0.85	1.05	0.95
Q	0.84	0.94	0.89

All Dimensions in mm

Suggested Pad Layout

Please see <http://www.diodes.com/package-outlines.html> for the latest version.

(1) Package Type: SOT25

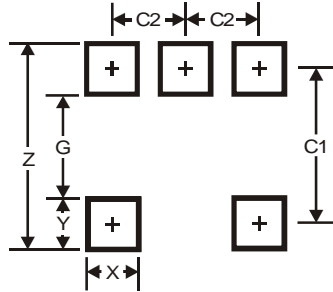

Dimensions	Value (in mm)
Z	3.20
G	1.60
X	0.55
Y	0.80
C1	2.40
C2	0.95

(2) Package Type: U-DFN2020-6

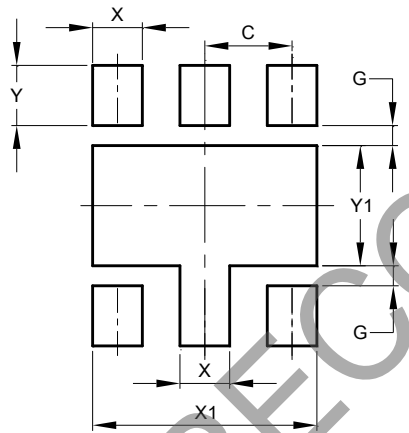

Dimensions	Value (in mm)
C	0.65
G	0.15
X	0.37
X1	1.67
Y	0.45
Y1	0.90

(3) Package Type: SOT89

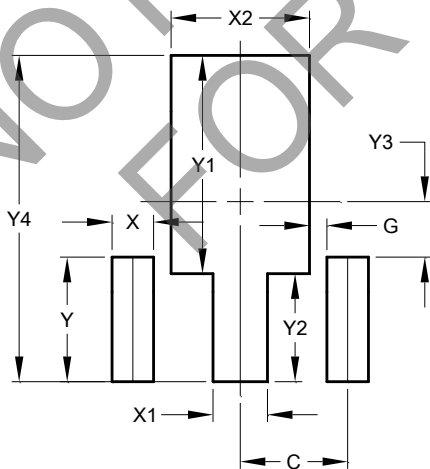

Dimensions	Value (in mm)
C	1.500
G	0.244
X	0.580
X1	0.760
X2	1.933
Y	1.730
Y1	3.030
Y2	1.500
Y3	0.770
Y4	4.530

Suggested Pad Layout (continued)

Please see <http://www.diodes.com/package-outlines.html> for the latest version.

(4) Package Type: SOT223

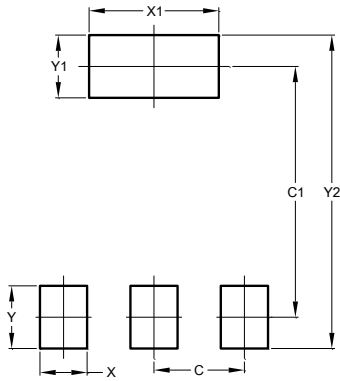

Dimensions	Value (in mm)
C	2.30
C1	6.40
X	1.20
X1	3.30
Y	1.60
Y1	1.60
Y2	8.00

Tape Orientation (Note 9)

For U-DFN2020-6

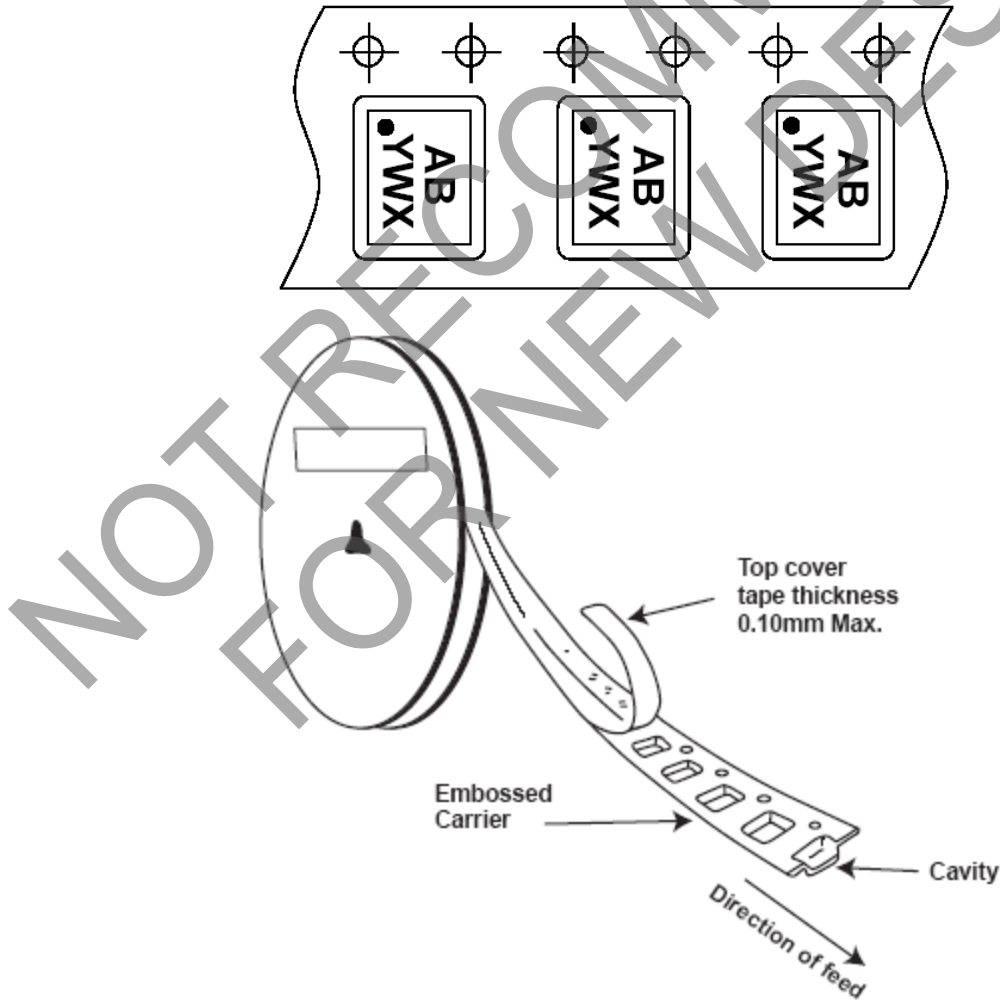

Note: 9. The taping orientation of the other package type can be found on our website at <https://www.diodes.com/assets/Packaging-Support-Docs/ap02007.pdf>

IMPORTANT NOTICE

DIODES INCORPORATED MAKES NO WARRANTY OF ANY KIND, EXPRESS OR IMPLIED, WITH REGARDS TO THIS DOCUMENT, INCLUDING, BUT NOT LIMITED TO, THE IMPLIED WARRANTIES OF MERCHANTABILITY AND FITNESS FOR A PARTICULAR PURPOSE (AND THEIR EQUIVALENTS UNDER THE LAWS OF ANY JURISDICTION).

Diodes Incorporated and its subsidiaries reserve the right to make modifications, enhancements, improvements, corrections or other changes without further notice to this document and any product described herein. Diodes Incorporated does not assume any liability arising out of the application or use of this document or any product described herein; neither does Diodes Incorporated convey any license under its patent or trademark rights, nor the rights of others. Any Customer or user of this document or products described herein in such applications shall assume all risks of such use and will agree to hold Diodes Incorporated and all the companies whose products are represented on Diodes Incorporated website, harmless against all damages.

Diodes Incorporated does not warrant or accept any liability whatsoever in respect of any products purchased through unauthorized sales channel. Should Customers purchase or use Diodes Incorporated products for any unintended or unauthorized application, Customers shall indemnify and hold Diodes Incorporated and its representatives harmless against all claims, damages, expenses, and attorney fees arising out of, directly or indirectly, any claim of personal injury or death associated with such unintended or unauthorized application.

Products described herein may be covered by one or more United States, international or foreign patents pending. Product names and markings noted herein may also be covered by one or more United States, international or foreign trademarks.

This document is written in English but may be translated into multiple languages for reference. Only the English version of this document is the final and determinative format released by Diodes Incorporated.

LIFE SUPPORT

Diodes Incorporated products are specifically not authorized for use as critical components in life support devices or systems without the express written approval of the Chief Executive Officer of Diodes Incorporated. As used herein:

A. Life support devices or systems are devices or systems which:

1. are intended to implant into the body, or
2. support or sustain life and whose failure to perform when properly used in accordance with instructions for use provided in the labeling can be reasonably expected to result in significant injury to the user.

B. A critical component is any component in a life support device or system whose failure to perform can be reasonably expected to cause the failure of the life support device or to affect its safety or effectiveness.

Customers represent that they have all necessary expertise in the safety and regulatory ramifications of their life support devices or systems, and acknowledge and agree that they are solely responsible for all legal, regulatory and safety-related requirements concerning their products and any use of Diodes Incorporated products in such safety-critical, life support devices or systems, notwithstanding any devices- or systems-related information or support that may be provided by Diodes Incorporated. Further, Customers must fully indemnify Diodes Incorporated and its representatives against any damages arising out of the use of Diodes Incorporated products in such safety-critical, life support devices or systems.

Copyright © 2020, Diodes Incorporated

www.diodes.com

Looking for pricing, stock, or lifecycle information?

Click below to explore more details on WIN SOURCE:

- ⊖ [View AP7365-25EG-13 on WIN SOURCE](#)
- ⊖ [Diodes Incorporated Information](#)

Optimize Your Supply Chain with WIN SOURCE Solutions

- ✓ Global Sourcing Solution
- ✓ Obsolete Management
- ✓ Cost Control Management
- ✓ Shortage Management
- ✓ Alternative Solution
- ✓ Excess Inventory Management