



THE DATASHEET OF BAT54T-7



Features

- Ultra-Small Surface Mount Package
- Low Forward Voltage Drop
- Fast Switching
- PN Junction Guard Ring for Transient and ESD Protection
- **Totally Lead-Free & Fully RoHS Compliant (Notes 1 & 2)**
- **Halogen and Antimony Free. "Green" Device (Note 3)**
- **Qualified to AEC-Q101 Standards for High Reliability**

Mechanical Data

- Case: SOT523
- Case Material: Molded Plastic, "Green" Molding Compound. UL Flammability Classification Rating 94V-0
- Moisture Sensitivity: Level 1 per J-STD-020
- Terminals: Finish - Matte Tin Annealed over Alloy 42 Leadframe. Solderable per MIL-STD-202, Method 208
- Lead-Free Plating
- Polarity: See Diagrams Below
- Weight: 0.002 grams (Approximate)



Top View

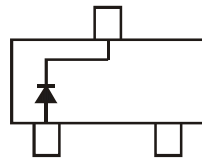

BAT54T

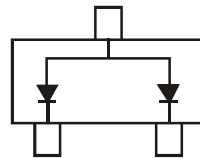

BAT54AT

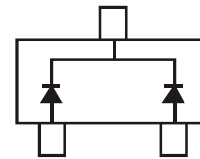

BAT54CT

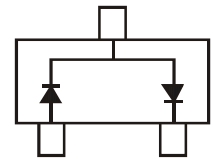

BAT54ST

Ordering Information (Note 4)

Part Number	Case	Packaging
BAT54T-7-F	SOT523	3,000/Tape & Reel
BAT54AT-7-F	SOT523	3,000/Tape & Reel
BAT54CT-7-F	SOT523	3,000/Tape & Reel
BAT54ST-7-F	SOT523	3,000/Tape & Reel

- Notes:
1. No purposely added lead. Fully EU Directive 2002/95/EC (RoHS), 2011/65/EU (RoHS 2) & 2015/863/EU (RoHS 3) compliant.
 2. See <https://www.diodes.com/quality/lead-free/> for more information about Diodes Incorporated's definitions of Halogen- and Antimony-free, "Green" and Lead-free.
 3. Halogen- and Antimony-free "Green" products are defined as those which contain <900ppm bromine, <900ppm chlorine (<1500ppm total Br + Cl) and <1000ppm antimony compounds.
 4. For packaging details, go to our website at <https://www.diodes.com/design/support/packaging/diodes-packaging/>.

Marking Information

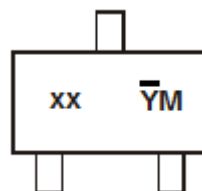
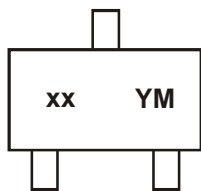

xx = Product Type Marking Code

L1 = BAT54T

L2 = BAT54AT

L3 = BAT54CT

L4 = BAT54ST

 YM or $\bar{Y}M$ = Date Code Marking

 Y or \bar{Y} = Year (ex: F = 2018)

M = Month (ex: 9 = September)

Date Code Key

Year	2002	...	2014	2015	2016	2017	2018	2019	2020	2021	2022	2023	2024	2025
Code	N	...	B	C	D	E	F	G	H	I	J	K	L	M

Month	Jan	Feb	Mar	Apr	May	Jun	Jul	Aug	Sep	Oct	Nov	Dec
Code	1	2	3	4	5	6	7	8	9	O	N	D

Maximum Ratings (@ $T_A = +25^\circ\text{C}$, unless otherwise specified.)

Characteristic	Symbol	Value	Unit
Peak Repetitive Reverse Voltage	V_{RRM}	30	V
Working Peak Reverse Voltage	V_{RWM}		
DC Blocking Voltage	V_R		
Forward Continuous Current (Note 5)	I_{FM}	200	mA
Repetitive Peak Forward Current	I_{FRM}	300	mA
Non-Repetitive Peak Forward Surge Current 8.3ms Single Half Sine-Wave Superimposed on Rated Load	I_{FSM}	600	mA

Thermal Characteristics

Characteristic	Symbol	Value	Unit
Power Dissipation (Note 5)	P_D	150	mW
Typical Thermal Resistance, Junction to Ambient (Note 5)	$R_{\theta JA}$	490	$^\circ\text{C/W}$
Operating and Storage Temperature Range	T_J, T_{STG}	-65 to +150	$^\circ\text{C}$

Electrical Characteristics (@ $T_A = +25^\circ\text{C}$, unless otherwise specified.)

Characteristic	Symbol	Min	Typ	Max	Unit	Test Condition
Reverse Breakdown Voltage (Note 6)	$V_{(BR)R}$	30	—	—	V	$I_R = 100\mu\text{A}$
Forward Voltage	V_F	—	—	240 320 400 500 1,000	mV	$I_F = 0.1\text{mA}$ $I_F = 1\text{mA}$ $I_F = 10\text{mA}$ $I_F = 30\text{mA}$ $I_F = 100\text{mA}$
Reverse Leakage Current (Note 6)	I_R	—	—	2.0	μA	$V_R = 25\text{V}$
Total Capacitance	C_T	—	—	10	pF	$V_R = 10\text{V}, f = 1.0\text{MHz}$
Reverse Recovery Time	t_{RR}	—	—	5.0	ns	$I_F = I_R = 10\text{mA}$, $I_{RR} = 0.1 \times I_R, R_L = 100\Omega$

- Notes:
- Device mounted on FR-4 substrate PC board with recommended pad layout, which can be found on our website at <http://www.diodes.com/package-outlines.html>.
 - Short duration pulse test used to minimize self-heating effect.

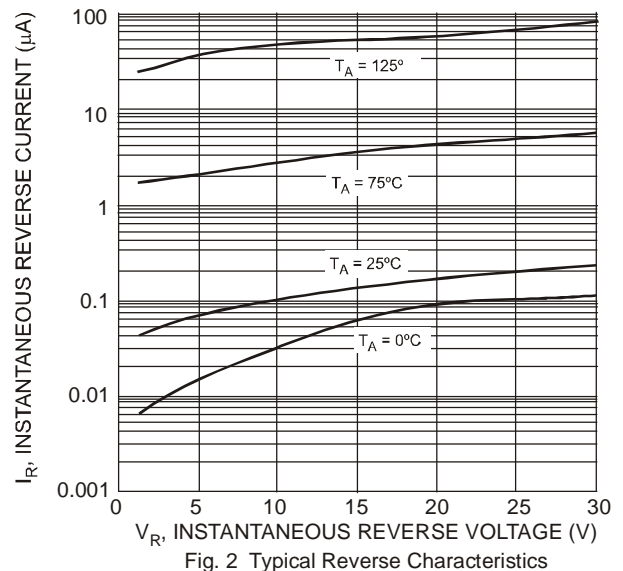
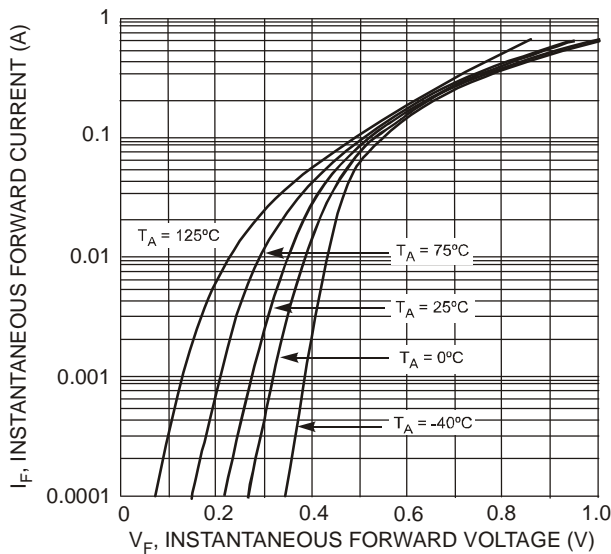

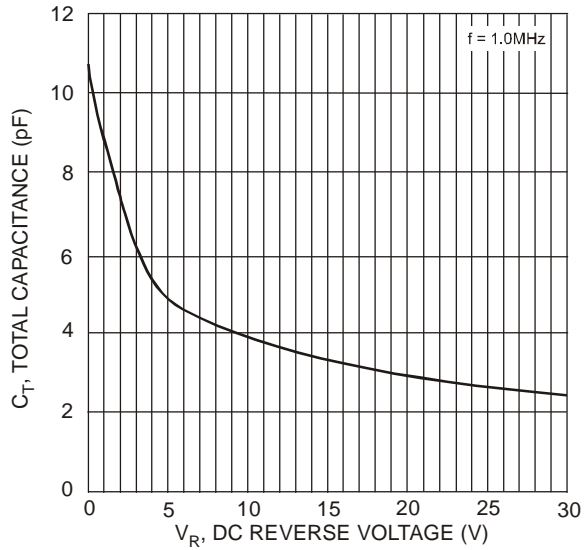

Fig. 3 Total Capacitance vs. Reverse Voltage

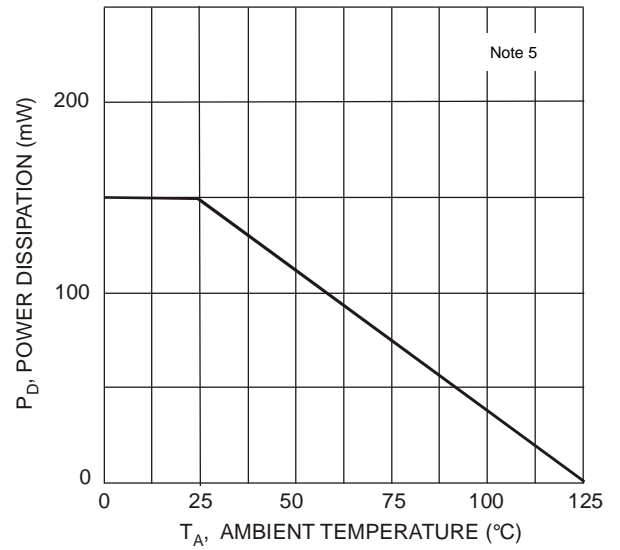
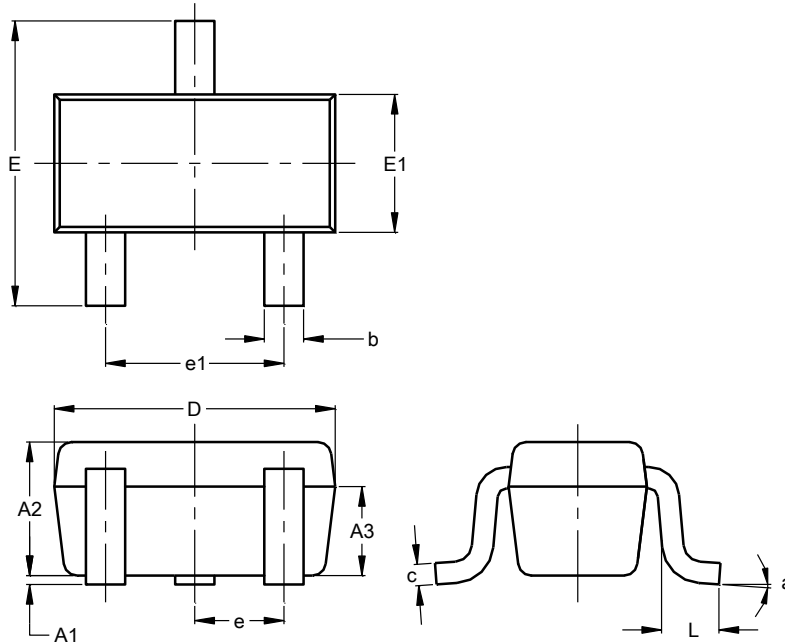

Fig. 4 Power Derating Curve

Package Outline Dimensions

Please see <http://www.diodes.com/package-outlines.html> for the latest version.

SOT523



SOT523			
Dim	Min	Max	Typ
A1	0.00	0.10	0.05
A2	0.60	0.80	0.75
A3	0.45	0.65	0.50
b	0.15	0.30	0.22
c	0.10	0.20	0.12
D	1.50	1.70	1.60
E	1.45	1.75	1.60
E1	0.75	0.85	0.80
e	0.50 BSC		
e1	0.90	1.10	1.00
L	0.20	0.40	0.33
a	0°	--	8°
All Dimensions in mm			

Suggested Pad Layout

Please see <http://www.diodes.com/package-outlines.html> for the latest version.

SOT523

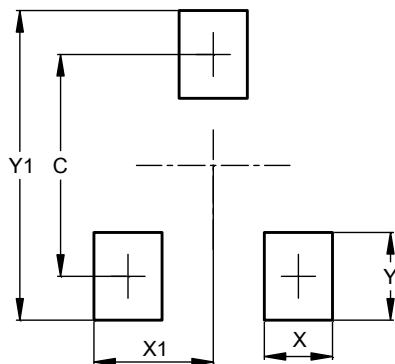

Dimensions	Value (in mm)
C	1.29
X	0.40
X1	0.70
Y	0.51
Y1	1.80

Note: The suggested land pattern dimensions have been provided for reference only, as actual pad layouts may vary depending on application. These dimensions may be modified based on user equipment capability or fabrication criteria. A more robust pattern may be desired for wave soldering and is calculated by adding 0.2 mm to the 'Z' dimension. For further information, please reference document IPC-7351A, Naming Convention for Standard SMT Land Patterns, and for International grid details, please see document IEC, Publication 97.

Note: For high voltage applications, the appropriate industry sector guidelines should be considered with regards to creepage and clearance distances between device Terminals and PCB tracking.

IMPORTANT NOTICE

DIODES INCORPORATED MAKES NO WARRANTY OF ANY KIND, EXPRESS OR IMPLIED, WITH REGARDS TO THIS DOCUMENT, INCLUDING, BUT NOT LIMITED TO, THE IMPLIED WARRANTIES OF MERCHANTABILITY AND FITNESS FOR A PARTICULAR PURPOSE (AND THEIR EQUIVALENTS UNDER THE LAWS OF ANY JURISDICTION).

Diodes Incorporated and its subsidiaries reserve the right to make modifications, enhancements, improvements, corrections or other changes without further notice to this document and any product described herein. Diodes Incorporated does not assume any liability arising out of the application or use of this document or any product described herein; neither does Diodes Incorporated convey any license under its patent or trademark rights, nor the rights of others. Any Customer or user of this document or products described herein in such applications shall assume all risks of such use and will agree to hold Diodes Incorporated and all the companies whose products are represented on Diodes Incorporated website, harmless against all damages.

Diodes Incorporated does not warrant or accept any liability whatsoever in respect of any products purchased through unauthorized sales channel. Should Customers purchase or use Diodes Incorporated products for any unintended or unauthorized application, Customers shall indemnify and hold Diodes Incorporated and its representatives harmless against all claims, damages, expenses, and attorney fees arising out of, directly or indirectly, any claim of personal injury or death associated with such unintended or unauthorized application.

Products described herein may be covered by one or more United States, international or foreign patents pending. Product names and markings noted herein may also be covered by one or more United States, international or foreign trademarks.

This document is written in English but may be translated into multiple languages for reference. Only the English version of this document is the final and determinative format released by Diodes Incorporated.

LIFE SUPPORT

Diodes Incorporated products are specifically not authorized for use as critical components in life support devices or systems without the express written approval of the Chief Executive Officer of Diodes Incorporated. As used herein:

A. Life support devices or systems are devices or systems which:

1. are intended to implant into the body, or
2. support or sustain life and whose failure to perform when properly used in accordance with instructions for use provided in the labeling can be reasonably expected to result in significant injury to the user.

B. A critical component is any component in a life support device or system whose failure to perform can be reasonably expected to cause the failure of the life support device or to affect its safety or effectiveness.



Customers represent that they have all necessary expertise in the safety and regulatory ramifications of their life support devices or systems, and acknowledge and agree that they are solely responsible for all legal, regulatory and safety-related requirements concerning their products and any use of Diodes Incorporated products in such safety-critical, life support devices or systems, notwithstanding any devices- or systems-related information or support that may be provided by Diodes Incorporated. Further, Customers must fully indemnify Diodes Incorporated and its representatives against any damages arising out of the use of Diodes Incorporated products in such safety-critical, life support devices or systems.

Copyright © 2018, Diodes Incorporated

www.diodes.com

Looking for pricing, stock, or lifecycle information?

Click below to explore more details on WIN SOURCE:

-  [View BAT54T-7 on WIN SOURCE](#)
-  [Diodes Incorporated Information](#)

Optimize Your Supply Chain with WIN SOURCE Solutions

-  Global Sourcing Solution
-  Obsolete Management
-  Cost Control Management
-  Shortage Management
-  Alternative Solution
-  Excess Inventory Management