



**THE DATASHEET OF
AUIRF7669L2TR**



Automotive DirectFET® Power MOSFET ②

- Advanced Process Technology
- Optimized for Automotive Motor Drive, DC-DC and other Heavy Load Applications
- Exceptionally Small Footprint and Low Profile
- High Power Density
- Low Parasitic Parameters
- Dual Sided Cooling
- 175°C Operating Temperature
- Repetitive Avalanche Capability for Robustness and Reliability
- Lead free, RoHS and Halogen free
- Automotive Qualified *

| | |
|--------------------------|--------------|
| $V_{(BR)DSS}$ | 100V |
| $R_{DS(on)}$ typ. | 3.5mΩ |
| | max. |
| I_D (Silicon Limited) | 114A |
| Q_g (typical) | 81nC |

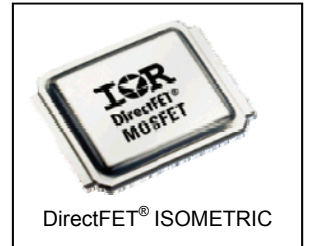
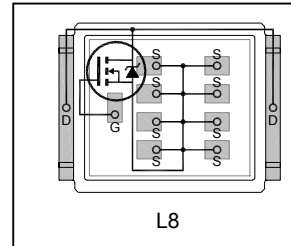

Applicable DirectFET® Outline and Substrate Outline ①

| | | | | | | | | |
|----|----|--|----|----|--|----|----|-----------|
| SB | SC | | M2 | M4 | | L4 | L6 | L8 |
|----|----|--|----|----|--|----|----|-----------|

Description

The AUIRF7669L2TR combines the latest Automotive HEXFET® Power MOSFET Silicon technology with the advanced DirectFET™ packaging to achieve the lowest on-state resistance in a package that has the footprint of a DPak (TO-252AA) and only 0.7 mm profile. The DirectFET package is compatible with existing layout geometries used in power applications, PCB assembly equipment and vapor phase, infra-red or convection soldering techniques, when application note AN-1035 is followed regarding the manufacturing methods and processes. The DirectFET package allows dual sided cooling to maximize thermal transfer in automotive power systems.

This HEXFET® Power MOSFET is designed for applications where efficiency and power density are essential. The advanced DirectFET packaging platform coupled with the latest silicon technology allows the AUIRF7669L2TR to offer substantial system level savings and performance improvement specifically in motor drive, high frequency DC-DC and other heavy load applications on ICE, HEV and EV platforms. This MOSFET utilizes the latest processing techniques to achieve low on-resistance and low Qg per silicon area. Additional features of this MOSFET are 175°C operating junction temperature and high repetitive peak current capability. These features combine to make this MOSFET a highly efficient, robust and reliable device for high current automotive applications..

| Base Part Number | Package Type | Standard Pack | | Orderable Part Number |
|------------------|---------------------|---------------|----------|-----------------------|
| | | Form | Quantity | |
| AUIRF7669L2 | DirectFET Large Can | Tape and Reel | 4000 | AUIRF7669L2TR |

Absolute Maximum Ratings

Stresses beyond those listed under "Absolute Maximum Ratings" may cause permanent damage to the device. These are stress ratings only; and functional operation of the device at these or any other condition beyond those indicated in the specifications is not implied. Exposure to absolute-maximum-rated conditions for extended periods may affect device reliability. The thermal resistance and power dissipation ratings are measured under board mounted and still air conditions. Ambient temperature (TA) is 25°C, unless otherwise specified.

| | Parameter | Max. | Units |
|---------------------------|--|---------------------------|-------|
| V_{DS} | Drain-to-Source Voltage | 100 | V |
| V_{GS} | Gate-to-Source Voltage | ±20 | |
| $I_D @ T_C = 25^\circ C$ | Continuous Drain Current, $V_{GS} @ 10V$ (Silicon Limited) ④ | 114 | A |
| $I_D @ T_C = 100^\circ C$ | Continuous Drain Current, $V_{GS} @ 10V$ (Silicon Limited) ④ | 81 | |
| $I_D @ T_A = 25^\circ C$ | Continuous Drain Current, $V_{GS} @ 10V$ (Silicon Limited) ③ | 19 | |
| $I_D @ T_C = 25^\circ C$ | Continuous Drain Current, $V_{GS} @ 10V$ (Package Limited) | 375 | |
| I_{DM} | Pulsed Drain Current ⑤ | 460 | |
| $P_D @ T_C = 25^\circ C$ | Power Dissipation ④ | 100 | W |
| $P_D @ T_A = 25^\circ C$ | Power Dissipation ③ | 3.3 | |
| E_{AS} | Single Pulse Avalanche Energy (Thermally Limited) ⑥ | 260 | mJ |
| $E_{AS (tested)}$ | Single Pulse Avalanche Energy (Tested Value) ⑤ | 850 | |
| I_{AR} | Avalanche Current ⑤ | See Fig. 16, 17, 18a, 18b | A |
| E_{AR} | Repetitive Avalanche Energy ⑤ | | mJ |
| T_P | Peak Soldering Temperature | 260 | °C |
| T_J | Operating Junction and | -55 to + 175 | |
| T_{STG} | Storage Temperature Range | | |

HEXFET® is a registered trademark of Infineon.

*Qualification standards can be found at www.infineon.com

Thermal Resistance

| Symbol | Parameter | Typ. | Max. | Units |
|--------------------|--------------------------|------|------|-------|
| $R_{\theta JA}$ | Junction-to-Ambient ③ | — | 45 | °C/W |
| $R_{\theta JA}$ | Junction-to-Ambient ⑧ | 12.5 | — | |
| $R_{\theta JA}$ | Junction-to-Ambient ⑨ | 20 | — | |
| $R_{\theta J-Can}$ | Junction-to-Can ④⑩ | — | 1.2 | |
| $R_{\theta J-PCB}$ | Junction-to-PCB Mounted | — | 0.5 | |
| | Linear Derating Factor ④ | 0.83 | | W/°C |

Static Electrical Characteristics @ $T_J = 25^\circ\text{C}$ (unless otherwise specified)

| Symbol | Parameter | Min. | Typ. | Max. | Units | Conditions |
|---------------------------------|--------------------------------------|------|------|------|-------|---|
| $V_{(BR)DSS}$ | Drain-to-Source Breakdown Voltage | 100 | — | — | V | $V_{GS} = 0V, I_D = 250\mu A$ |
| $\Delta V_{(BR)DSS}/\Delta T_J$ | Breakdown Voltage Temp. Coefficient | — | 0.08 | — | V/°C | Reference to $25^\circ\text{C}, I_D = 1.0\text{mA}$ |
| $R_{DS(on)}$ | Static Drain-to-Source On-Resistance | — | 3.5 | 4.4 | mΩ | $V_{GS} = 10V, I_D = 68A$ ⑦ |
| $V_{GS(th)}$ | Gate Threshold Voltage | 3.0 | 4.0 | 5.0 | V | $V_{DS} = V_{GS}, I_D = 250\mu A$ |
| $\Delta V_{GS(th)}/\Delta T_J$ | Gate Threshold Voltage Coefficient | — | -13 | — | mV/°C | |
| g_{fs} | Forward Transconductance | 90 | — | — | S | $V_{DS} = 25V, I_D = 68A$ |
| R_G | Internal Gate Resistance | — | 1.5 | — | Ω | |
| I_{DSS} | Drain-to-Source Leakage Current | — | — | 5.0 | μA | $V_{DS} = 100V, V_{GS} = 0V$ |
| | | — | — | 250 | | $V_{DS} = 100V, V_{GS} = 0V, T_J = 125^\circ\text{C}$ |
| I_{GSS} | Gate-to-Source Forward Leakage | — | — | 100 | nA | $V_{GS} = 20V$ |
| | Gate-to-Source Reverse Leakage | — | — | -100 | | $V_{GS} = -20V$ |

Dynamic Electrical Characteristics @ $T_J = 25^\circ\text{C}$ (unless otherwise specified)

| Symbol | Parameter | Min. | Typ. | Max. | Units | Conditions |
|-----------------------|--------------------------------------|------|------|------|-------|--|
| Q_g | Total Gate Charge | — | 81 | 120 | nC | $V_{DS} = 50V$ $V_{GS} = 10V$ $I_D = 68A$ See Fig.11 |
| Q_{gs1} | Gate-to-Source Charge | — | 23 | — | | |
| Q_{gs2} | Gate-to-Source Charge | — | 6.8 | — | | |
| Q_{gd} | Gate-to-Drain ("Miller") Charge | — | 34 | — | | |
| Q_{godr} | Gate Charge Overdrive | — | 17.2 | — | | |
| Q_{sw} | Switch Charge ($Q_{gs2} + Q_{gd}$) | — | 40.8 | — | | |
| Q_{oss} | Output Charge | — | 46 | — | nC | $V_{DS} = 16V, V_{GS} = 0V$ |
| $t_{d(on)}$ | Turn-On Delay Time | — | 15 | — | ns | $V_{DD} = 50V, V_{GS} = 10V$ ⑦ $I_D = 68A$ $R_G = 1.8\Omega$ |
| t_r | Rise Time | — | 30 | — | | |
| $t_{d(off)}$ | Turn-Off Delay Time | — | 27 | — | | |
| t_f | Fall Time | — | 14 | — | | |
| C_{iss} | Input Capacitance | — | 5660 | — | pF | $V_{GS} = 0V$ |
| C_{oss} | Output Capacitance | — | 1140 | — | | $V_{DS} = 25V$ |
| C_{rss} | Reverse Transfer Capacitance | — | 240 | — | | $f = 1.0\text{MHz}$ |
| C_{oss} | Output Capacitance | — | 9250 | — | | $V_{GS} = 0V, V_{DS} = 1.0V, f = 1.0\text{MHz}$ |
| C_{oss} | Output Capacitance | — | 660 | — | | $V_{GS} = 0V, V_{DS} = 80V, f = 1.0\text{MHz}$ |
| $C_{oss\text{ eff.}}$ | Effective Output Capacitance | — | 1040 | — | | $V_{GS} = 0V, V_{DS} = 0V\text{ to }80V$ |

Notes ① through ⑩ are on page 3

Diode Characteristics

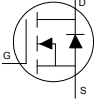
| Symbol | Parameter | Min. | Typ. | Max. | Units | Conditions |
|----------|--|------|------|------|-------|--|
| I_S | Continuous Source Current (Body Diode) | — | — | 114 | A | MOSFET symbol showing the integral reverse p-n junction diode.  |
| I_{SM} | Pulsed Source Current (Body Diode) ⑤ | — | — | 460 | | |
| V_{SD} | Diode Forward Voltage | — | — | 1.3 | V | $T_J = 25^\circ\text{C}$, $I_S = 68\text{A}$, $V_{GS} = 0\text{V}$ ⑦ |
| t_{rr} | Reverse Recovery Time | — | 61 | 92 | ns | $T_J = 25^\circ\text{C}$, $I_F = 68\text{A}$, $V_{DD} = 50\text{V}$ |
| Q_{rr} | Reverse Recovery Charge | — | 140 | 210 | nC | $dv/dt = 100\text{A}/\mu\text{s}$ ⑦ |



③ Surface mounted on 1 in. square Cu board (still air).

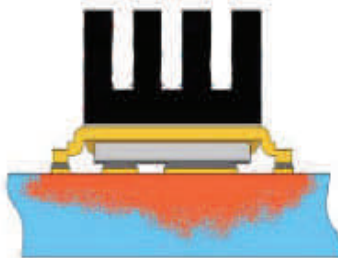

⑨ Mounted to a PCB with small clip heatsink (still air)

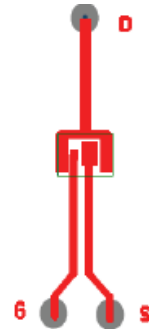

⑩ Mounted on minimum footprint full size board with metalized back and with small clip heatsink (still air).

- ① Click on this section to link to the appropriate technical paper.
- ② Click on this section to link to the DirectFET® Website.
- ③ Surface mounted on 1 in. square Cu board, steady state.
- ④ T_C measured with thermocouple mounted to top (Drain) of part.
- ⑤ Repetitive rating; pulse width limited by max. junction temperature.
- ⑥ Starting $T_J = 25^\circ\text{C}$, $L = 0.11\text{mH}$, $R_G = 25\Omega$, $I_{AS} = 68\text{A}$.
- ⑦ Pulse width $\leq 400\mu\text{s}$; duty cycle $\leq 2\%$.
- ⑧ Used double sided cooling, mounting pad with large heatsink.
- ⑨ Mounted on minimum footprint full size board with metalized back and with small clip heat sink.
- ⑩ R_θ is measured at T_J of approximately 90°C .

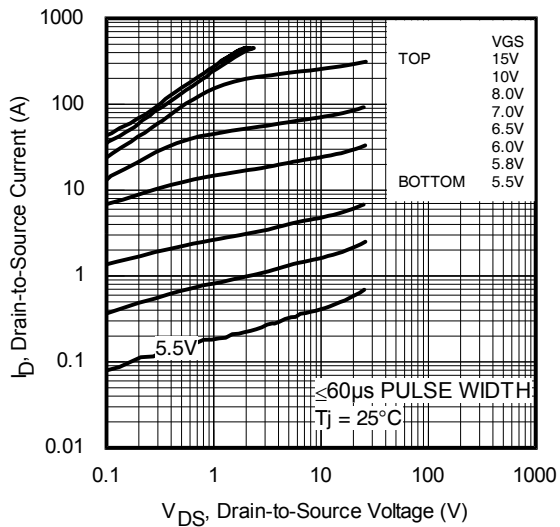

Fig. 1 Typical Output Characteristics

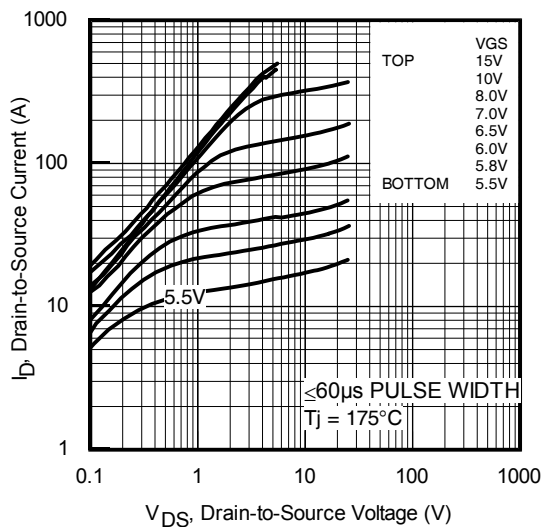

Fig. 2 Typical Output Characteristics

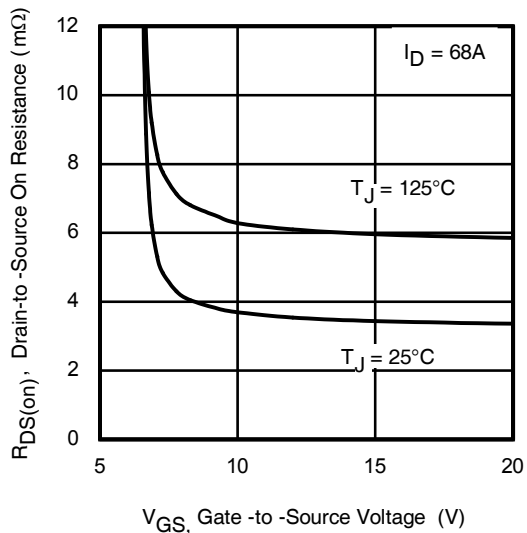

Fig. 3 Typical On-Resistance vs. Gate Voltage

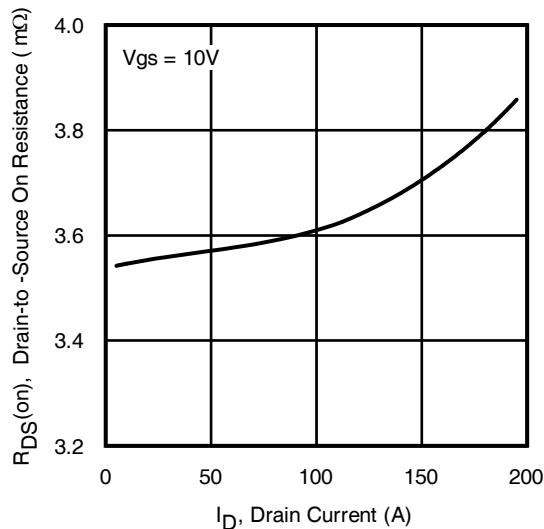

Fig. 4 Typical On-Resistance vs. Drain Current

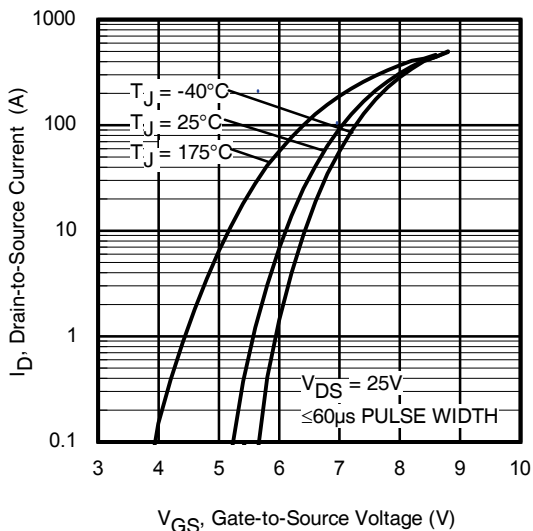

Fig. 5. Typical Transfer Characteristics

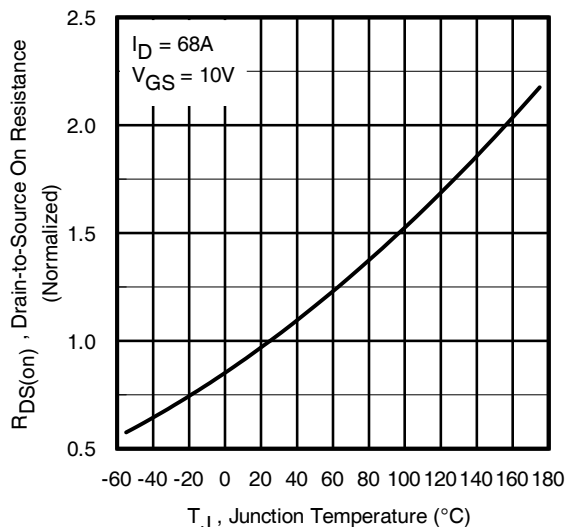

Fig. 6. Normalized On-Resistance vs. Temperature

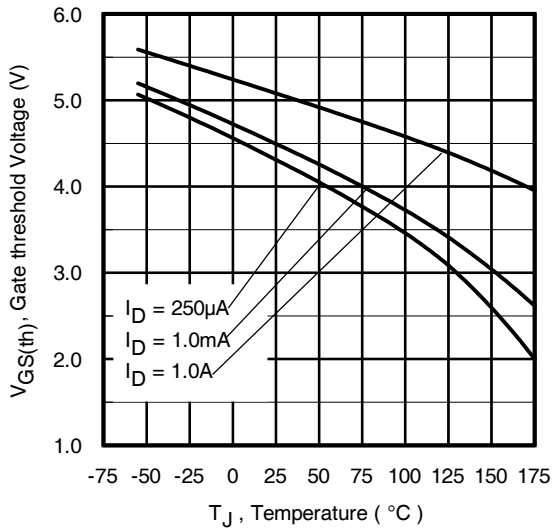

Fig. 7 Typical Threshold Voltage vs. Junction Temperature

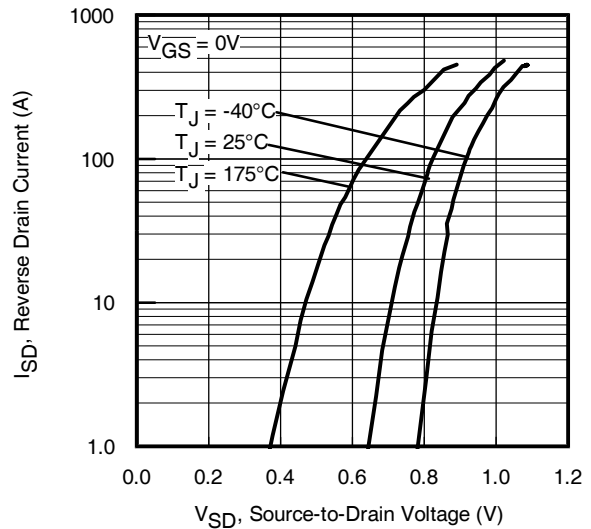

Fig. 8. Typical Source-Drain Diode Forward Voltage

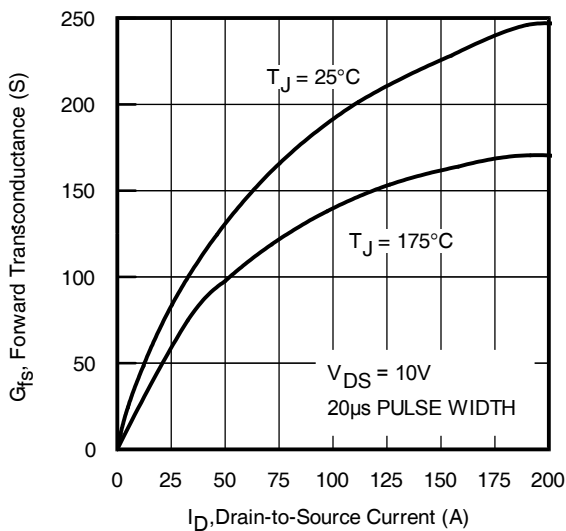

Fig 9. Typical Forward Trans conductance vs. Drain Current

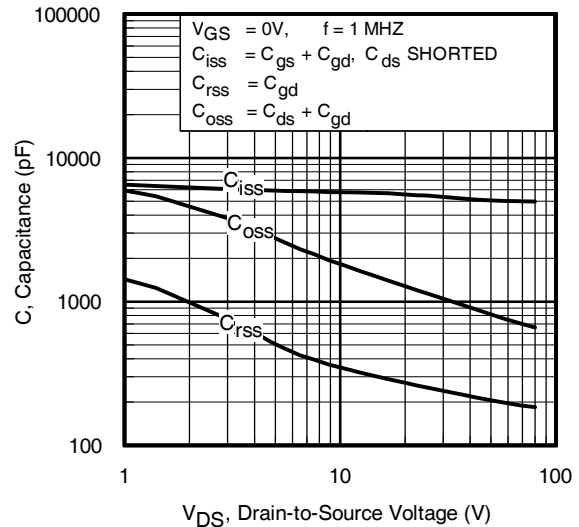

Fig 10. Typical Capacitance vs. Drain-to-Source Voltage

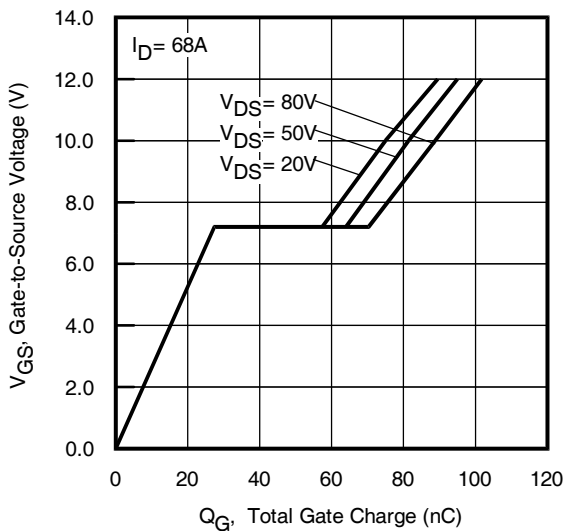

Fig 11. Typical Gate Charge vs. Gate-to-Source Voltage

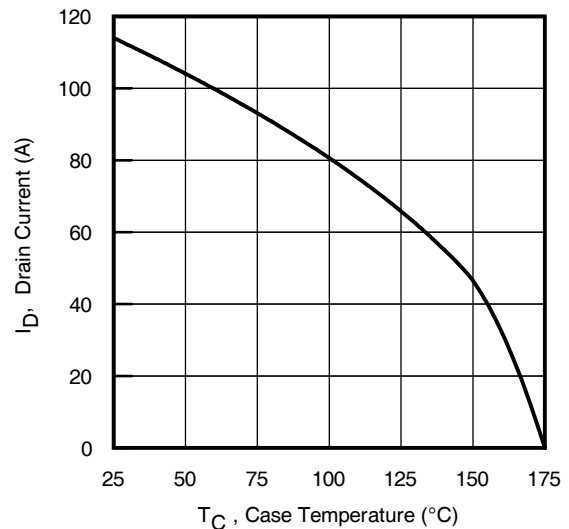

Fig 12. Maximum Drain Current vs. Case Temperature

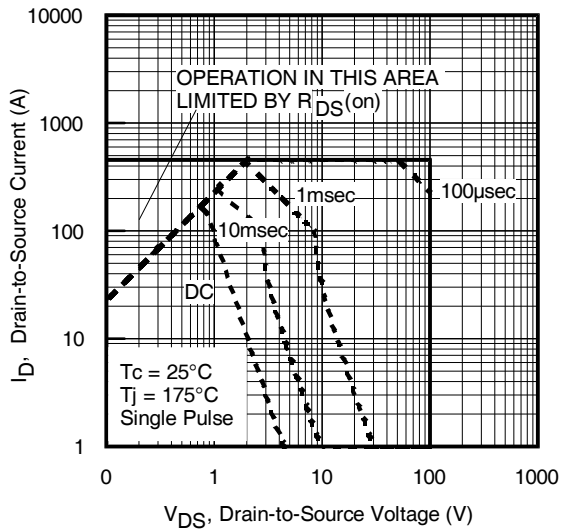

Fig 13. Maximum Safe Operating Area

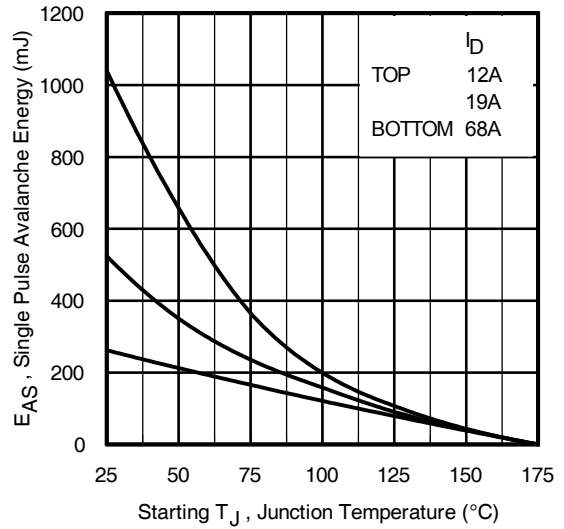

Fig 14. Maximum Avalanche Energy vs. Temperature

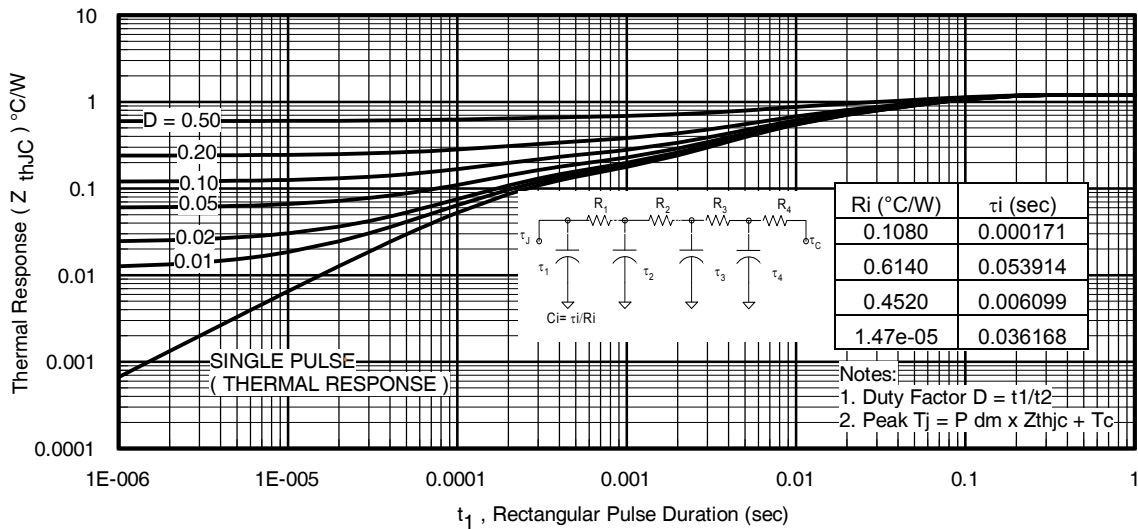

Fig 15. Maximum Effective Transient Thermal Impedance, Junction-to-Case

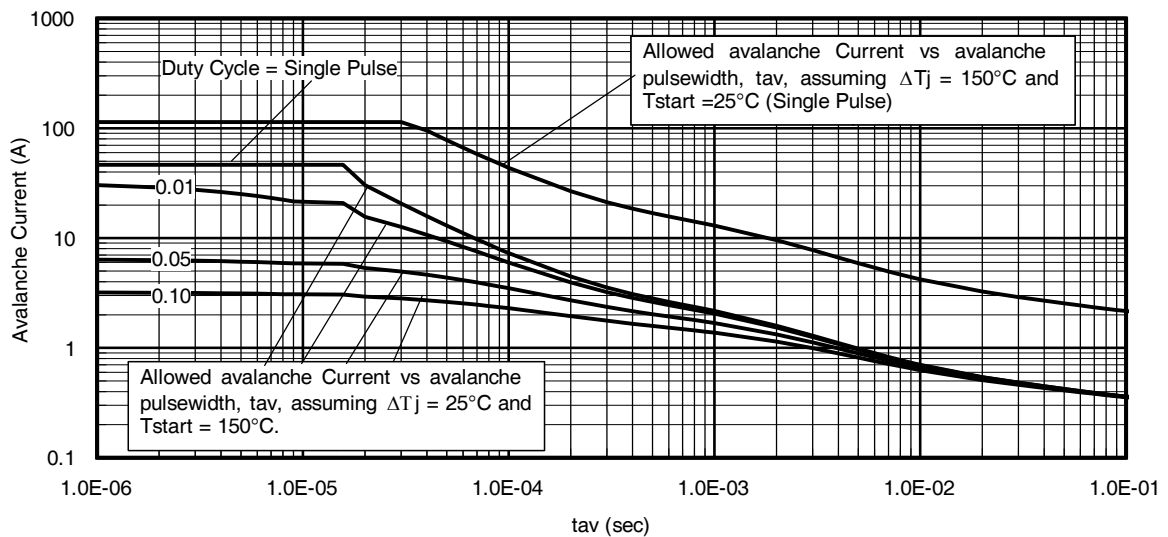

Fig 16. Typical Avalanche Current vs. Pulse Width

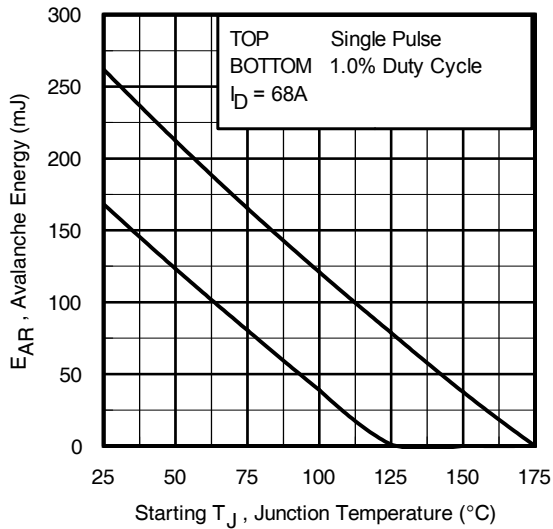

Fig 17. Maximum Avalanche Energy vs. Temperature

Notes on Repetitive Avalanche Curves , Figures 16, 17:

(For further info, see AN-1005 at www.infineon.com)

1. Avalanche failures assumption:
Purely a thermal phenomenon and failure occurs at a temperature far in excess of T_{jmax} . This is validated for every part type.
2. Safe operation in Avalanche is allowed as long as T_{jmax} is not exceeded.
3. Equation below based on circuit and waveforms shown in Figures 18a, 18b.
4. $P_{D(ave)}$ = Average power dissipation per single avalanche pulse.
5. BV = Rated breakdown voltage (1.3 factor accounts for voltage increase during avalanche).
6. I_{av} = Allowable avalanche current.
7. ΔT = Allowable rise in junction temperature, not to exceed T_{jmax} (assumed as 25°C in Figure 16, 17).
 t_{av} = Average time in avalanche.
 D = Duty cycle in avalanche = $t_{av} \cdot f$
 $Z_{thJC}(D, t_{av})$ = Transient thermal resistance, see Figures 15)

$$P_{D(ave)} = 1/2 (1.3 \cdot BV \cdot I_{av}) = \Delta T / Z_{thJC}$$

$$I_{av} = 2\Delta T / [1.3 \cdot BV \cdot Z_{th}]$$

$$E_{AS(AR)} = P_{D(ave)} \cdot t_{av}$$

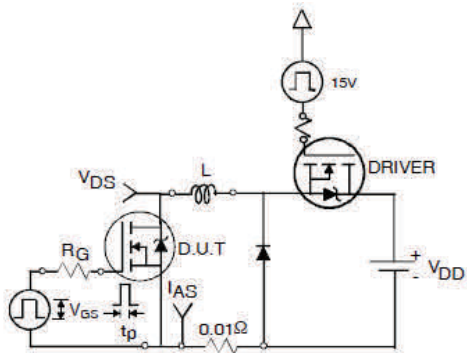

Fig 18a. Unclamped Inductive Test Circuit

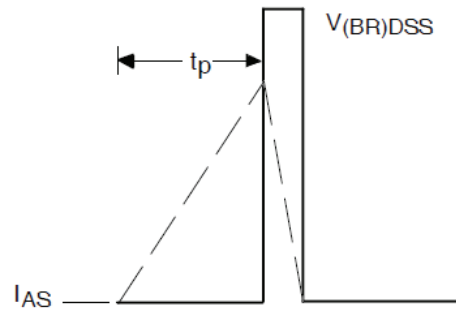

Fig 18b. Unclamped Inductive Waveforms

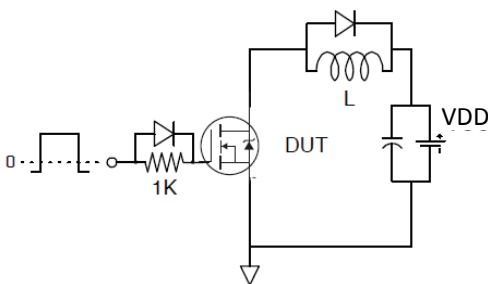

Fig 19a. Gate Charge Test Circuit

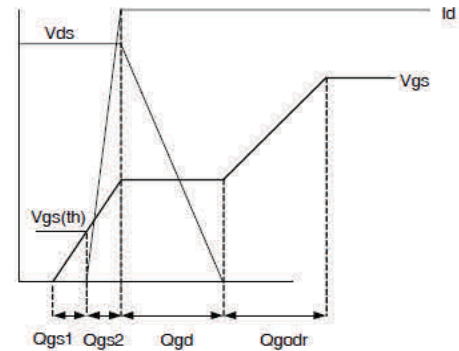

Fig 19b. Gate Charge Waveform

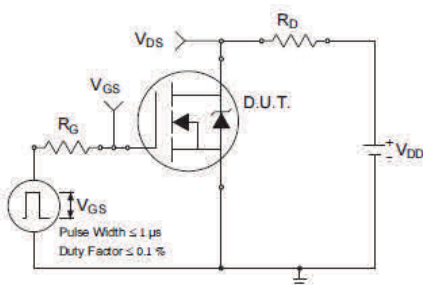

Fig 20a. Switching Time Test Circuit

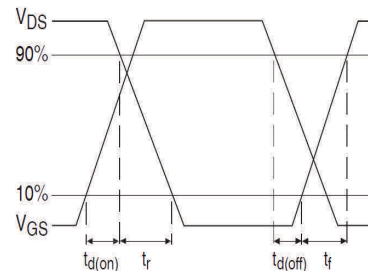
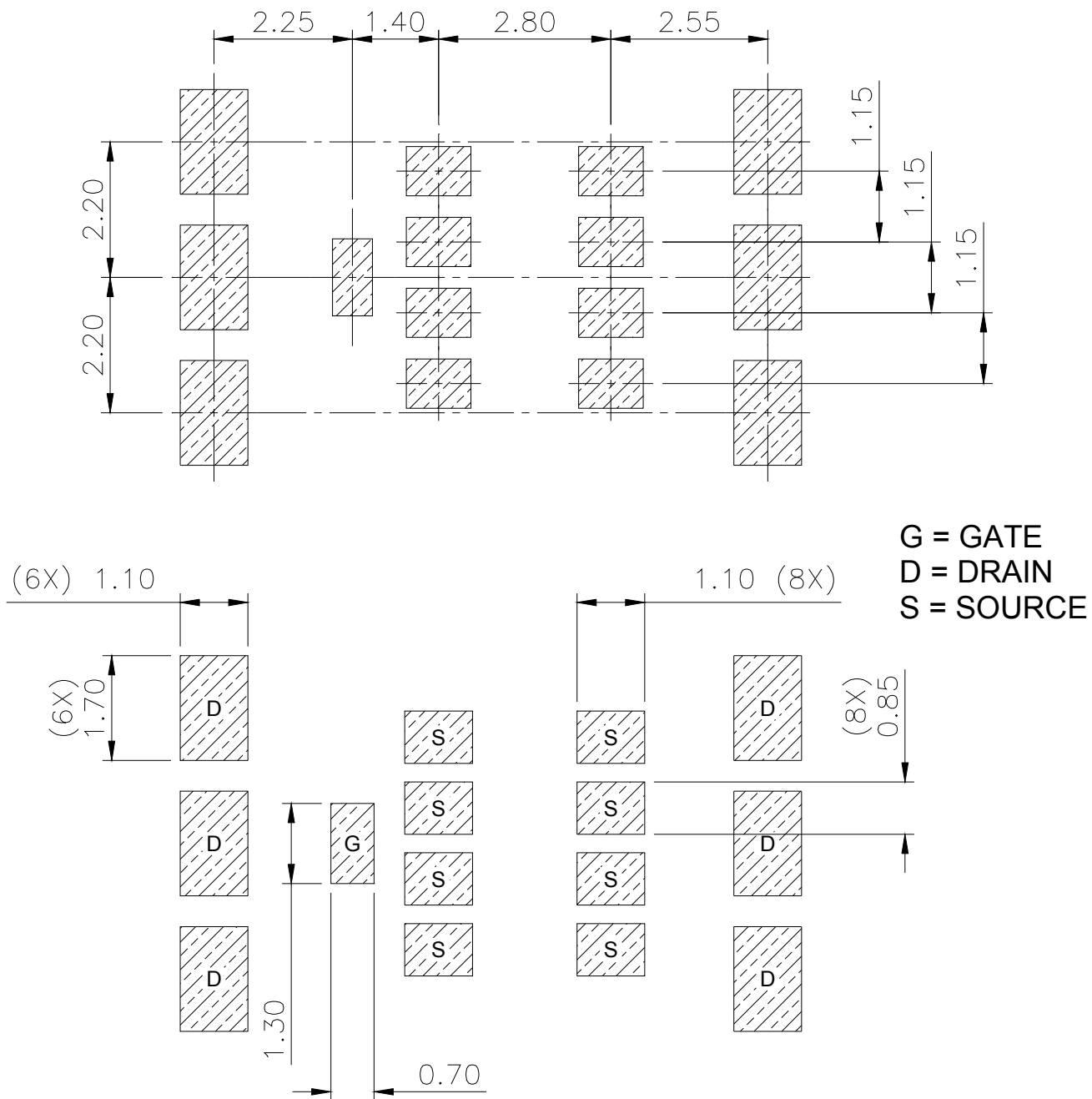

Fig 20b. Switching Time Waveforms

DirectFET® Board Footprint, L8 (Large Size Can).

Please see DirectFET® application note AN-1035 for all details regarding the assembly of DirectFET®. This includes all recommendations for stencil and substrate designs.



Note: For the most current drawing please refer to IR website at <http://www.irf.com/package/>

DirectFET® Outline Dimension, L8 (Large Size Can).

Please see DirectFET® application note AN-1035 for all details regarding the assembly of DirectFET®. This includes all recommendations for stencil and substrate designs.

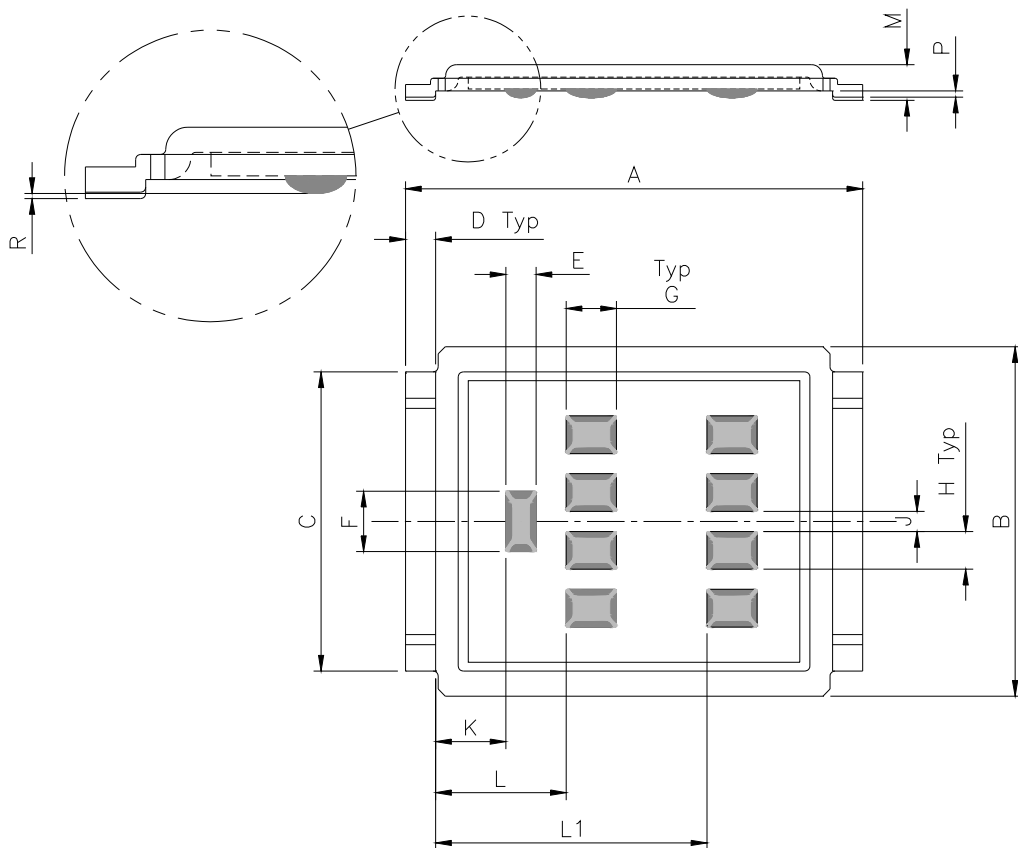

| CODE | DIMENSIONS | | | |
|------|------------|------|----------|-------|
| | METRIC | | IMPERIAL | |
| | MIN | MAX | MIN | MAX |
| A | 9.05 | 9.15 | 0.356 | 0.360 |
| B | 6.85 | 7.10 | 0.270 | 0.280 |
| C | 5.90 | 6.00 | 0.232 | 0.236 |
| D | 0.55 | 0.65 | 0.022 | 0.026 |
| E | 0.58 | 0.62 | 0.023 | 0.024 |
| F | 1.18 | 1.22 | 0.046 | 0.048 |
| G | 0.98 | 1.02 | 0.039 | 0.040 |
| H | 0.73 | 0.77 | 0.029 | 0.030 |
| J | 0.38 | 0.42 | 0.015 | 0.017 |
| K | 1.35 | 1.45 | 0.053 | 0.057 |
| L | 2.55 | 2.65 | 0.100 | 0.104 |
| L1 | 5.35 | 5.45 | 0.211 | 0.215 |
| M | 0.68 | 0.74 | 0.027 | 0.029 |
| P | 0.09 | 0.17 | 0.003 | 0.007 |
| R | 0.02 | 0.08 | 0.001 | 0.003 |

DirectFET® Part Marking

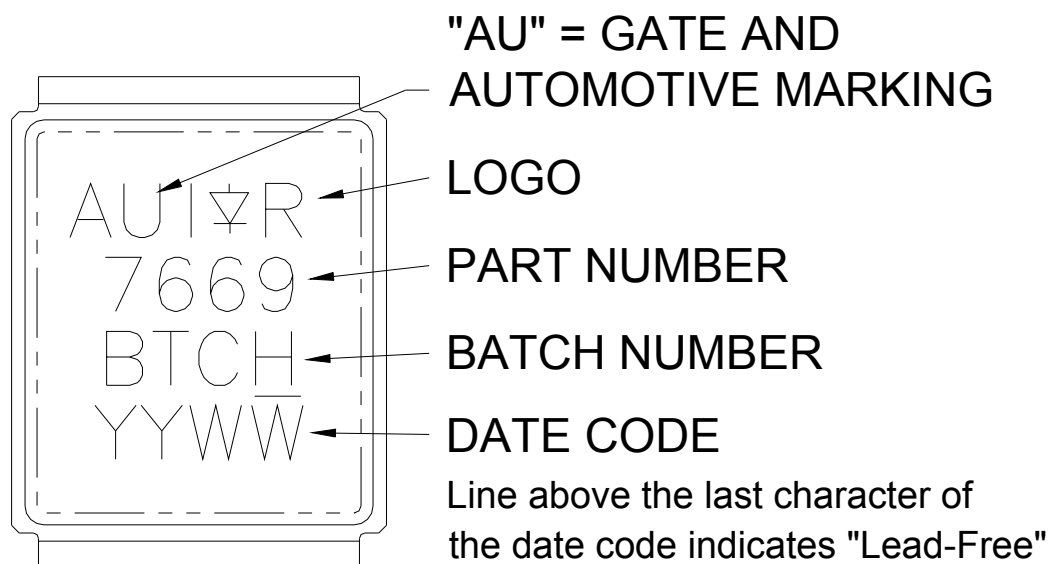

Note: For the most current drawing please refer to IR website at <http://www.irf.com/package/>

DirectFET® Tape & Reel Dimension (Showing component orientation)

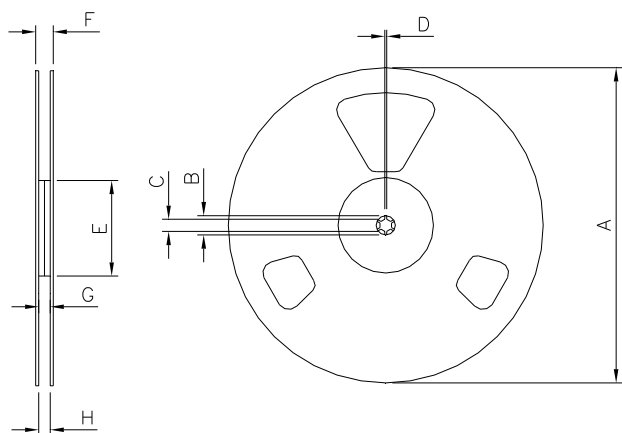

NOTE: Controlling dimensions in mm
Std reel quantity is 4000 parts, ordered as AUIRF7669L2TR.

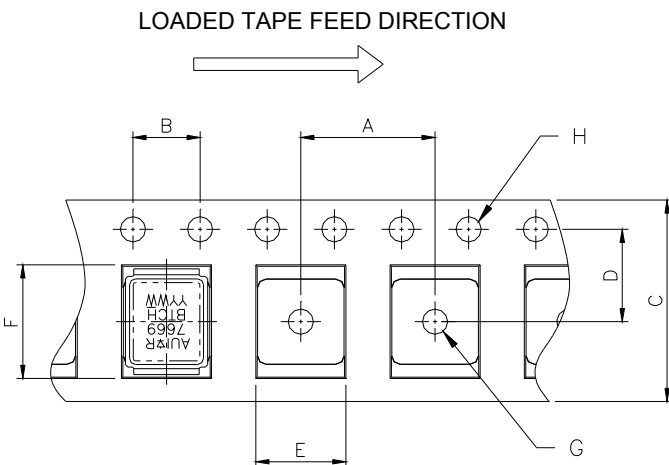

| REEL DIMENSIONS | | | | |
|----------------------------|--------|--------|----------|-------|
| STANDARD OPTION (QTY 4000) | | | | |
| CODE | METRIC | | IMPERIAL | |
| | MIN | MAX | MIN | MAX |
| A | 330.00 | N.C | 12.992 | N.C |
| B | 20.20 | N.C | 0.795 | N.C |
| C | 12.80 | 13.20 | 0.504 | 0.520 |
| D | 1.50 | N.C | 0.059 | N.C |
| E | 99.00 | 100.00 | 3.900 | 3.940 |
| F | N.C | 22.40 | N.C | 0.880 |
| G | 16.40 | 18.40 | 0.650 | 0.720 |
| H | 15.90 | 19.40 | 0.630 | 0.760 |

NOTE: CONTROLLING DIMENSIONS IN MM

| CODE | DIMENSIONS | | | |
|------|------------|-------|----------|-------|
| | METRIC | | IMPERIAL | |
| | MIN | MAX | MIN | MAX |
| A | 11.90 | 12.10 | 4.69 | 0.476 |
| B | 3.90 | 4.10 | 0.154 | 0.161 |
| C | 15.90 | 16.30 | 0.623 | 0.642 |
| D | 7.40 | 7.60 | 0.291 | 0.299 |
| E | 7.20 | 7.40 | 0.283 | 0.291 |
| F | 9.90 | 10.10 | 0.390 | 0.398 |
| G | 1.50 | N.C | 0.059 | N.C |
| H | 1.50 | 1.60 | 0.059 | 0.063 |

Note: For the most current drawing please refer to IR website at <http://www.irf.com/package/>

Qualification Information

| | | | |
|-----------------------------------|----------------------|---|------|
| Qualification Level | | Automotive (per AEC-Q101) | |
| | | Comments: This part number(s) passed Automotive qualification. Infineon's Industrial and Consumer qualification level is granted by extension of the higher Automotive level. | |
| Moisture Sensitivity Level | | DFET2 Large Can | MSL1 |
| ESD | Machine Model | Class M4 [†] AEC-Q101-002 | |
| | Human Body Model | Class H2 [†] AEC-Q101-001 | |
| | Charged Device Model | Class C4 [†] AEC-Q101-005 | |
| RoHS Compliant | | Yes | |

† Highest passing voltage.

Revision History

| Date | Comments |
|------------|---|
| 11/16/2015 | <ul style="list-style-type: none"> Updated datasheet with corporate template Corrected ordering table on page 1. Updated Tape and Reel option on page 10 |

Published by
Infineon Technologies AG
81726 München, Germany
© Infineon Technologies AG 2015
All Rights Reserved.

IMPORTANT NOTICE

The information given in this document shall in no event be regarded as a guarantee of conditions or characteristics ("Beschaffheitsgarantie"). With respect to any examples, hints or any typical values stated herein and/or any information regarding the application of the product, Infineon Technologies hereby disclaims any and all warranties and liabilities of any kind, including without limitation warranties of non-infringement of intellectual property rights of any third party.

In addition, any information given in this document is subject to customer's compliance with its obligations stated in this document and any applicable legal requirements, norms and standards concerning customer's products and any use of the product of Infineon Technologies in customer's applications.

The data contained in this document is exclusively intended for technically trained staff. It is the responsibility of customer's technical departments to evaluate the suitability of the product for the intended application and the completeness of the product information given in this document with respect to such application.

For further information on the product, technology, delivery terms and conditions and prices please contact your nearest Infineon Technologies office (www.infineon.com).

WARNINGS

Due to technical requirements products may contain dangerous substances. For information on the types in question please contact your nearest Infineon Technologies office.

Except as otherwise explicitly approved by Infineon Technologies in a written document signed by authorized representatives of Infineon Technologies, Infineon Technologies' products may not be used in any applications where a failure of the product or any consequences of the use thereof can reasonably be expected to result in personal injury.

Looking for pricing, stock, or lifecycle information?

Click below to explore more details on WIN SOURCE:

 [View AUIRF7669L2TR on WIN SOURCE](#)

 [Infineon Technologies](#) Information

Optimize Your Supply Chain with WIN SOURCE Solutions

-  Global Sourcing Solution
-  Obsolete Management
-  Cost Control Management
-  Shortage Management
-  Alternative Solution
-  Excess Inventory Management