



# THE DATASHEET OF BA2904YF-CE2



Operational Amplifier Series

# Automotive Ground Sense Operational Amplifiers



## BA2904Yxxx-C, BA2902Yxx-C

●General Description

BA2904Yxxx-C, BA2902Yxx-C integrate two or four independent Op-Amps and ground sense input Amplifier on a single chip. These Op-Amps have some features of high-gain, low power consumption, and can operate from +3V to +36V (single power supply). BA2904Yxxx-C, BA2902Yxx-C are manufactured for automotive requirements of engine control unit, electric power steering, and so on.

●Features

- AEC-Q100 Qualified
- Single or dual power supply operation
- Wide operating supply voltage
- Standard Op-Amp Pin-assignments
- Common-mode Input Voltage Range includes ground level, allowing direct ground sensing
- Low supply current
- High open loop voltage gain
- Internal ESD protection circuit
- Wide temperature range

●Application

- Engine Control Unit
- Electric Power Steering (EPS)
- Anti-Lock Braking System (ABS)
- Automotive electronics

●Key Specifications

- Wide operating supply voltage
  - Single supply : +3.0V to +36V
  - Dual supply : ±1.5V to ±18V
- Low supply current
 

|              |             |
|--------------|-------------|
| BA2904Yxxx-C | 0.5mA(Typ.) |
| BA2902Yxx-C  | 0.7mA(Typ.) |
- Input bias current : 20nA(Typ.)
- Input offset current : 2nA(Typ.)
- Operating temperature range : -40°C to +125°C

●Packages

|          | W(Typ.) x D(Typ.) x (Max.) |
|----------|----------------------------|
| SOP8     | 5.00mm x 6.20mm x 1.71mm   |
| SOP14    | 8.70mm x 6.20mm x 1.71mm   |
| SSOP-B8  | 3.00mm x 6.40mm x 1.35mm   |
| SSOP-B14 | 5.00mm x 6.40mm x 1.35mm   |
| MSOP8    | 2.90mm x 4.00mm x 0.90mm   |

●Selection Guide

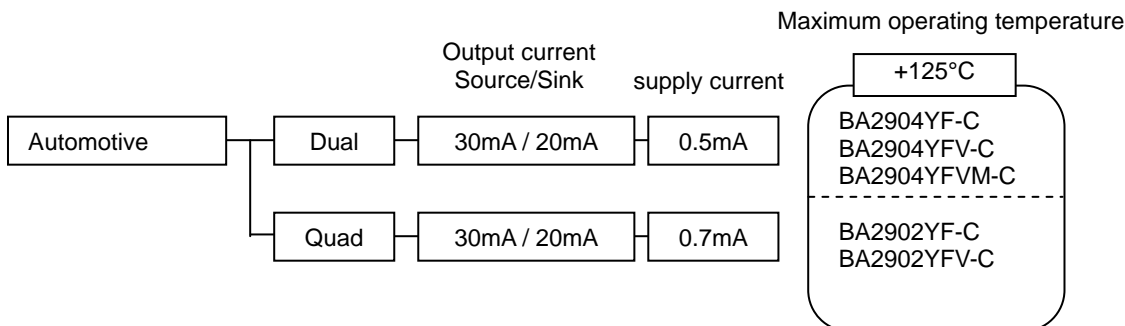

○Product structure : Silicon monolithic integrated circuit ○This product is not designed protection against radioactive rays.

●Simplified schematic

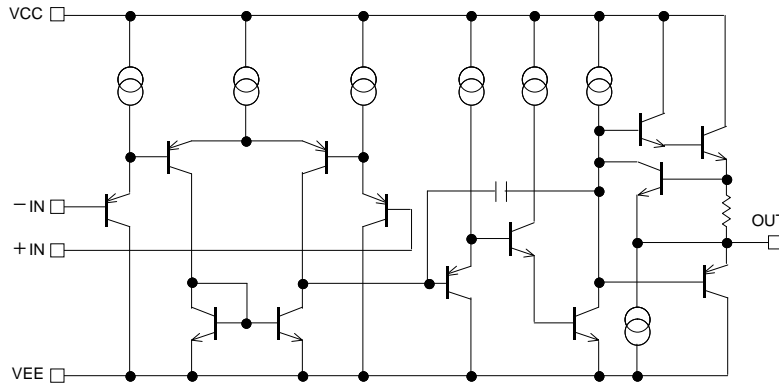
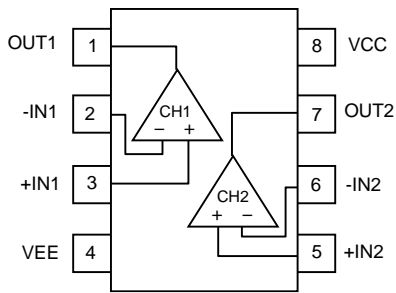

Figure 1. Simplified schematic (one channel only)

●Pin Configuration

BA2904YF-C : SOP8  
 BA2904YFV-C : SSOP-B8  
 BA2904YFVM-C : MSOP8



| Pin No. | Pin name |
|---------|----------|
| 1       | OUT1     |
| 2       | -IN1     |
| 3       | +IN1     |
| 4       | VEE      |
| 5       | +IN2     |
| 6       | -IN2     |
| 7       | OUT2     |
| 8       | VCC      |

BA2902YF-C : SOP14  
 BA2902YFV-C : SSOP-B14



| Pin No. | Pin name |
|---------|----------|
| 1       | OUT1     |
| 2       | -IN1     |
| 3       | +IN1     |
| 4       | VCC      |
| 5       | +IN2     |
| 6       | -IN2     |
| 7       | OUT2     |
| 8       | OUT3     |
| 9       | -IN3     |
| 10      | +IN3     |
| 11      | VEE      |
| 12      | +IN4     |
| 13      | -IN4     |
| 14      | OUT4     |

| Package    |             |              |            |             |
|------------|-------------|--------------|------------|-------------|
| SOP8       | SSOP-B8     | MSOP8        | SOP14      | SSOP-B14    |
| BA2904YF-C | BA2904YFV-C | BA2904YFVM-C | BA2902YF-C | BA2902YFV-C |

●Ordering Information

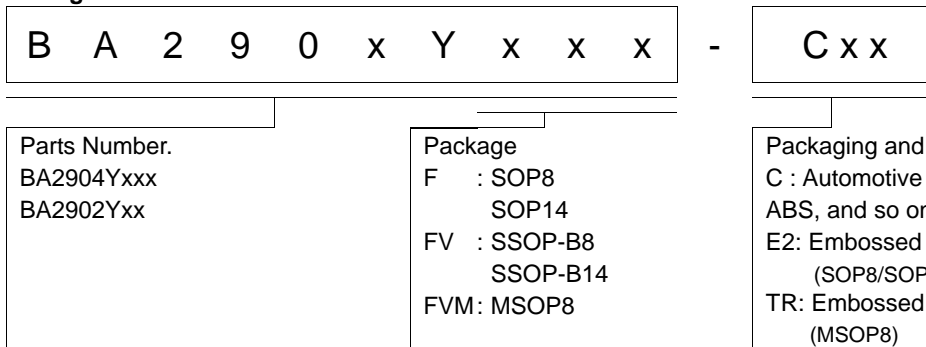

●Line-up

| Topr            | Operating Supply Voltage | Number of channels | Package  |              | Orderable Parts Number |
|-----------------|--------------------------|--------------------|----------|--------------|------------------------|
| -40°C to +125°C | +3.0V to +36V            | Dual               | SOP8     | Reel of 2500 | BA2904YF-CE2           |
|                 |                          |                    | SSOP-B8  | Reel of 2500 | BA2904YFV-CE2          |
|                 |                          |                    | MSOP8    | Reel of 3000 | BA2904YFVM-CTR         |
|                 |                          | Quad               | SOP14    | Reel of 2500 | BA2902YF-CE2           |
|                 |                          |                    | SSOP-B14 | Reel of 2500 | BA2902YFV-CE2          |

●Absolute Maximum Ratings(Ta=25°C)

| Parameter                                | Symbol  | Ratings                      | Unit                |
|--|---------|------------------------------|---------------------|
| Supply Voltage                           | VCC-VEE | +36                          | V                   |
| Power Dissipation                        | Pd      | SOP8                         | 770 <sup>*1*6</sup> |
|  |         | SSOP-B8                      | 620 <sup>*2*6</sup> |
|  |         | MSOP8                        | 580 <sup>*3*6</sup> |
|  |         | SOP14                        | 560 <sup>*4*6</sup> |
|  |         | SSOP-B14                     | 870 <sup>*5*6</sup> |
| Differential Input Voltage <sup>*7</sup> | Vid     | +36                          | V                   |
| Input Common-mode Voltage Range          | Vicm    | (VEE-0.3) to (VEE+36)        | V                   |
| Input Current <sup>*8</sup>              | Ii      | -10                          | mA                  |
| Operating Supply Voltage                 | Vopr    | +3.0 to +36<br>(±1.5 to ±18) | V                   |
| Operating Temperature Range              | Topr    | -40 to +125                  | °C                  |
| Storage Temperature Range                | Tstg    | -55 to +150                  | °C                  |
| Maximum Junction Temperature             | Tjmax   | +150                         | °C                  |

Note: Absolute maximum rating item indicates the condition which must not be exceeded.  
 Application if voltage in excess of absolute maximum rating or use out of absolute maximum rated temperature environment may cause deterioration of characteristics.

\*1 To use at temperature above Ta=25°C reduce 6.2mW/°C.  
 \*2 To use at temperature above Ta=25°C reduce 5.0mW/°C.  
 \*3 To use at temperature above Ta=25°C reduce 4.7mW/°C.  
 \*4 To use at temperature above Ta=25°C reduce 4.5mW/°C.  
 \*5 To use at temperature above Ta=25°C reduce 7.0mW/°C.  
 \*6 Mounted on a FR4 glass epoxy PCB(70mm×70mm×1.6mm).  
 \*7 The voltage difference between inverting input and non-inverting input is the differential input voltage.  
 Then input pin voltage is set to more than VEE.  
 \*8 An excessive input current will flow when input voltages of lesser than VEE-0.6V are applied.  
 The input current can be set to less than the rated current by adding a limiting resistor.

### ●Electrical Characteristics

OBA2904Yxxx-C (Unless otherwise specified VCC=+5V, VEE=0V)

| Parameter                            | Symbol  | Temperature Range | Limits |      |         | Unit                        | Conditions                                       |
|--------------------------------------|---------|-------------------|--------|------|---------|-----------------------------|--|
|                                      |         |                   | Min.   | Typ. | Max.    |                             |  |
| Input Offset Voltage <sup>*9</sup>   | Vio     | 25°C              | -      | 2    | 3.5     | mV                          | OUT=1.4V   |
|                                      |         | Full range        | -      | -    | 4       |                             | VCC=5 to 30V, OUT=1.4V                           |
| Input Offset Current <sup>*9</sup>   | Iio     | 25°C              | -      | 2    | 40      | nA                          | OUT=1.4V   |
|                                      |         | Full range        | -      | -    | 50      |                             |  |
| Input Bias Current <sup>*9</sup>     | Ib      | 25°C              | -      | 20   | 60      | nA                          | OUT=1.4V   |
|                                      |         | Full range        | -      | -    | 100     |                             |  |
| Supply Current                       | ICC     | 25°C              | -      | 0.5  | 1.2     | mA                          | RL=∞, All Op-Amps                                |
|                                      |         | Full range        | -      | -    | 1.2     |                             |  |
| Maximum Output Voltage (High)        | VOH     | 25°C              | 3.5    | -    | -       | V                           | RL=2kΩ   |
|                                      |         | Full range        | 3.2    | -    | -       |                             | VCC=30V, RL=10kΩ                                 |
| Maximum Output Voltage(Low)          | VOL     | Full range        | -      | 5    | 20      | mV                          | RL=∞, All Op-Amps                                |
| Large Signal Voltage Gain            | Av      | 25°C              | 25     | 100  | -       | V/mV                        | RL ≥ 2kΩ, VCC=15V<br>OUT=1.4 to 11.4V            |
|                                      |         | Full range        | 25     | -    | -       |                             |  |
| Input Common-mode Voltage Range      | Vicm    | 25°C              | 0      | -    | VCC-1.5 | V                           | (VCC-VEE)=5V,<br>OUT=VEE+1.4V                    |
|                                      |         | Full range        | 0      | -    | VCC-2.0 |                             |  |
| Common-mode Rejection Ratio          | CMRR    | 25°C              | 65     | 80   | -       | dB                          | OUT=1.4V   |
| Power Supply Rejection Ratio         | PSRR    | 25°C              | 65     | 100  | -       | dB                          | VCC=5 to 30V                                     |
| Output Source Current <sup>*10</sup> | Isource | 25°C              | 20     | 30   | -       | mA                          | +IN=1V, -IN=0V<br>OUT=0V<br>1CH is short circuit |
|                                      |         | Full range        | 10     | -    | -       |                             |  |
| Output Sink Current <sup>*10</sup>   | Isink   | 25°C              | 10     | 20   | -       | mA                          | +IN=0V, -IN=1V<br>OUT=5V<br>1CH is short circuit |
|                                      |         | Full range        | 2      | -    | -       |                             |  |
|                                      | 25°C    | 12                | 40     | -    | μA      | +IN=0V, -IN=1V<br>OUT=200mV |  |
| Slew Rate                            | SR      | 25°C              | -      | 0.2  | -       | V/μs                        | VCC=15V, Av=0dB<br>RL=2kΩ, CL=100pF              |
| Gain Bandwidth Product               | GBW     | 25°C              | -      | 0.5  | -       | MHz                         | VCC=30V, RL=2kΩ<br>CL=100pF                      |
| Channel Separation                   | CS      | 25°C              | -      | 120  | -       | dB                          | f=1kHz, input referred                           |

<sup>\*9</sup> Absolute value

<sup>\*10</sup> Under high temperatures, please consider the power dissipation when selecting the output current.

When the output terminal is continuously shorted the output current reduces the internal temperature by flushing.

OBA2902Yxx-C (Unless otherwise specified VCC=+5V, VEE=0V)

| Parameter                            | Symbol  | Temperature Range | Limits |      |         | Unit                        | Conditions                                       |
|--------------------------------------|---------|-------------------|--------|------|---------|-----------------------------|--|
|                                      |         |                   | Min.   | Typ. | Max.    |                             |  |
| Input Offset Voltage <sup>*11</sup>  | Vio     | 25°C              | -      | 2    | 3.8     | mV                          | OUT=1.4V   |
|                                      |         | Full range        | -      | -    | 4       |                             | VCC=5 to 30V, OUT=1.4V                           |
| Input Offset Current <sup>*11</sup>  | Iio     | 25°C              | -      | 2    | 40      | nA                          | OUT=1.4V   |
|                                      |         | Full range        | -      | -    | 50      |                             |  |
| Input Bias Current <sup>*11</sup>    | Ib      | 25°C              | -      | 20   | 60      | nA                          | OUT=1.4V   |
|                                      |         | Full range        | -      | -    | 100     |                             |  |
| Supply Current                       | ICC     | 25°C              | -      | 0.7  | 2       | mA                          | RL=∞, All Op-Amps                                |
|                                      |         | Full range        | -      | -    | 3       |                             |  |
| Maximum Output Voltage (High)        | VOH     | 25°C              | 3.5    | -    | -       | V                           | RL=2kΩ   |
|                                      |         | Full range        | 3.2    | -    | -       |                             | VCC=30V, RL=10kΩ                                 |
| Maximum Output Voltage(Low)          | VOL     | Full range        | -      | 5    | 20      | mV                          | RL=∞, All Op-Amps                                |
| Large Signal Voltage Gain            | Av      | 25°C              | 25     | 100  | -       | V/mV                        | RL ≥ 2kΩ, VCC=15V<br>OUT=1.4 to 11.4V            |
|                                      |         | Full range        | 25     | -    | -       |                             |  |
| Input Common-mode Voltage Range      | Vicm    | 25°C              | 0      | -    | VCC-1.5 | V                           | (VCC-VEE)=5V,<br>OUT=VEE+1.4V                    |
|                                      |         | Full range        | 0      | -    | VCC-2.0 |                             |  |
| Common-mode Rejection Ratio          | CMRR    | 25°C              | 65     | 80   | -       | dB                          | OUT=1.4V   |
| Power Supply Rejection Ratio         | PSRR    | 25°C              | 65     | 100  | -       | dB                          | VCC=5 to 30V                                     |
| Output Source Current <sup>*12</sup> | Isource | 25°C              | 20     | 30   | -       | mA                          | +IN=1V, -IN=0V<br>OUT=0V<br>1CH is short circuit |
|                                      |         | Full range        | 10     | -    | -       |                             |  |
| Output Sink Current <sup>*12</sup>   | Isink   | 25°C              | 10     | 20   | -       | mA                          | +IN=0V, -IN=1V<br>OUT=5V<br>1CH is short circuit |
|                                      |         | Full range        | 2      | -    | -       |                             |  |
|                                      | 25°C    | 12                | 40     | -    | μA      | +IN=0V, -IN=1V<br>OUT=200mV |  |
| Slew Rate                            | SR      | 25°C              | -      | 0.2  | -       | V/μs                        | VCC=15V, Av=0dB<br>RL=2kΩ, CL=100pF              |
| Gain Bandwidth Product               | GBW     | 25°C              | -      | 0.5  | -       | MHz                         | VCC=30V, RL=2kΩ<br>CL=100pF                      |
| Channel Separation                   | CS      | 25°C              | -      | 120  | -       | dB                          | f=1kHz, input referred                           |

\*11 Absolute value

\*12 Under high temperatures, please consider the power dissipation when selecting the output current.

When the output terminal is continuously shorted the output current reduces the internal temperature by flushing.

### Description of Electrical Characteristics

Described below are descriptions of the relevant electrical terms used in this datasheet. Items and symbols used are also shown. Note that item name and symbol and their meaning may differ from those on another manufacturer's document or general document.

#### 1. Absolute maximum ratings

Absolute maximum rating items indicate the condition which must not be exceeded. Application of voltage in excess of absolute maximum rating or use out of absolute maximum rated temperature environment may cause deterioration of characteristics.

##### 1.1 Supply Voltage (VCC-VEE)

Indicates the maximum voltage that can be applied between the positive power supply terminal and negative power supply terminal without deterioration or destruction of characteristics of internal circuit.

##### 1.2 Differential Input Voltage (V<sub>id</sub>)

Indicates the maximum voltage that can be applied between non-inverting and inverting terminals without damaging the IC.

##### 1.3 Input Common-mode Voltage Range (V<sub>icm</sub>)

Indicates the maximum voltage that can be applied to the non-inverting and inverting terminals without deterioration or destruction of electrical characteristics. Input common-mode voltage range of the maximum ratings does not assure normal operation of IC. For normal operation, use the IC within the input common-mode voltage range characteristics.

##### 1.4 Operating and Storage Temperature Ranges (T<sub>opr</sub>, T<sub>stg</sub>)

The operating temperature range indicates the temperature range within which the IC can operate. The higher the ambient temperature, the lower the power consumption of the IC. The storage temperature range denotes the range of temperatures the IC can be stored under without causing excessive deterioration of the electrical characteristics.

##### 1.5 Power Dissipation (P<sub>d</sub>)

Indicates the power that can be consumed by the IC when mounted on a specific board at the ambient temperature 25°C (normal temperature). As for package product, P<sub>d</sub> is determined by the temperature that can be permitted by the IC in the package (maximum junction temperature) and the thermal resistance of the package.

#### 2. Electrical characteristics

##### 2.1 Input Offset Voltage (V<sub>io</sub>)

Indicates the voltage difference between non-inverting terminal and inverting terminals. It can be translated into the input voltage difference required for setting the output voltage at 0 V.

##### 2.2 Input Offset Current (I<sub>io</sub>)

Indicates the difference of input bias current between the non-inverting and inverting terminals.

##### 2.3 Input Bias Current (I<sub>b</sub>)

Indicates the current that flows into or out of the input terminal. It is defined by the average of input bias currents at the non-inverting and inverting terminals.

##### 2.4 Supply Current (I<sub>CC</sub>)

Indicates the current that flows within the IC under specified no-load conditions.

##### 2.5 Maximum Output Voltage (High) / Maximum Output Voltage (Low) (V<sub>OH</sub>/V<sub>OL</sub>)

Indicates the voltage range of the output under specified load condition. It is typically divided into high-level output voltage and low-level output voltage. High-level output voltage indicates the upper limit of output voltage while Low-level output voltage indicates the lower limit.

##### 2.6 Large Signal Voltage Gain (A<sub>v</sub>)

Indicates the amplifying rate (gain) of output voltage against the voltage difference between non-inverting terminal and inverting terminal. It is normally the amplifying rate (gain) with reference to DC voltage.

$$A_v = (\text{Output voltage}) / (\text{Differential input voltage})$$

##### 2.7 Input Common-mode Voltage Range (V<sub>icm</sub>)

Indicates the input voltage range where IC normally operates.

##### 2.8 Common-mode Rejection Ratio (CMRR)

Indicates the ratio of fluctuation of input offset voltage when the input common mode voltage is changed. It is normally the fluctuation of DC.

$$\text{CMRR} = (\text{Change of Input common-mode voltage}) / (\text{Input offset fluctuation})$$

**2.9 Power Supply Rejection Ratio (PSRR)**

Indicates the ratio of fluctuation of input offset voltage when supply voltage is changed. It is normally the fluctuation of DC.

$$\text{PSRR} = (\text{Change of power supply voltage}) / (\text{Input offset fluctuation})$$

**2.10 Output Source Current/ Output Sink Current (I<sub>source</sub> / I<sub>sink</sub>)**

The maximum current that can be output from the IC under specific output conditions. The output source current indicates the current flowing out from the IC, and the output sink current indicates the current flowing into the IC.

**2.11 Slew Rate (SR)**

Indicates the ratio of the change in output voltage with time when a step input signal is applied.

**2.12 Gain Bandwidth Product (GBW)**

The product of the open-loop voltage gain and the frequency at which the voltage gain decreases 6dB/octave.

**2.13 Channel Separation (CS)**

Indicates the fluctuation in the output voltage of the driven channel with reference to the change of output voltage of the channel which is not driven.

● Typical Performance Curves

OBA2904Yxxx-C

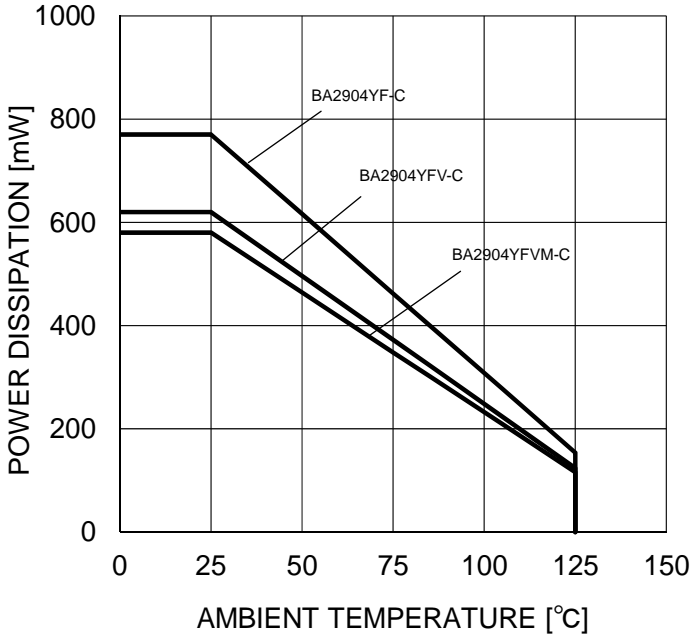

Figure 2.  
Derating Curve

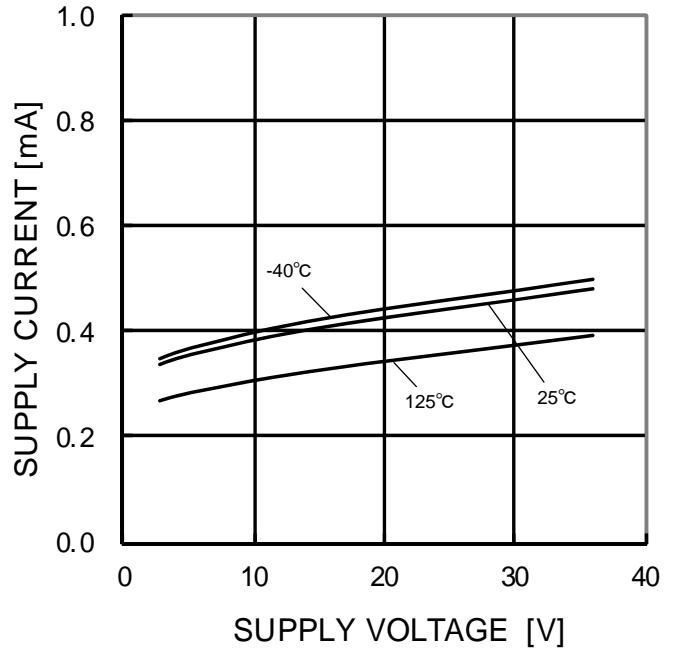

Figure 3.  
Supply Current – Supply Voltage

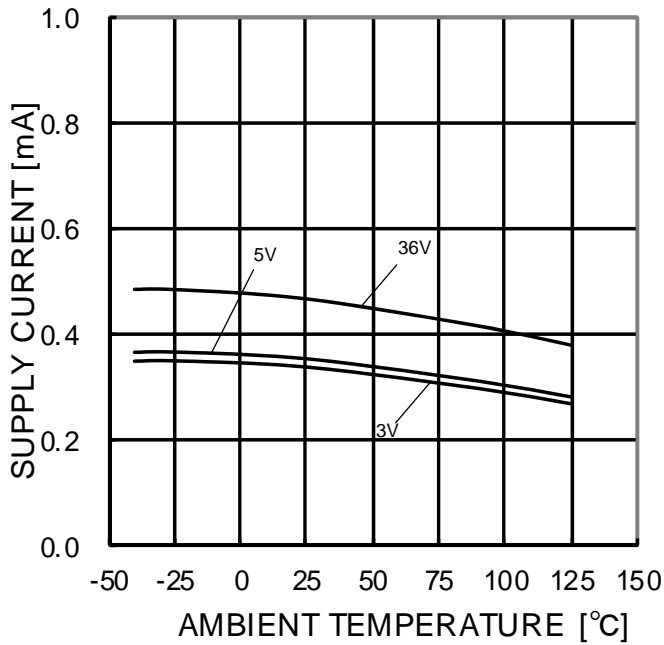

Figure 4.  
Supply Current – Ambient Temperature

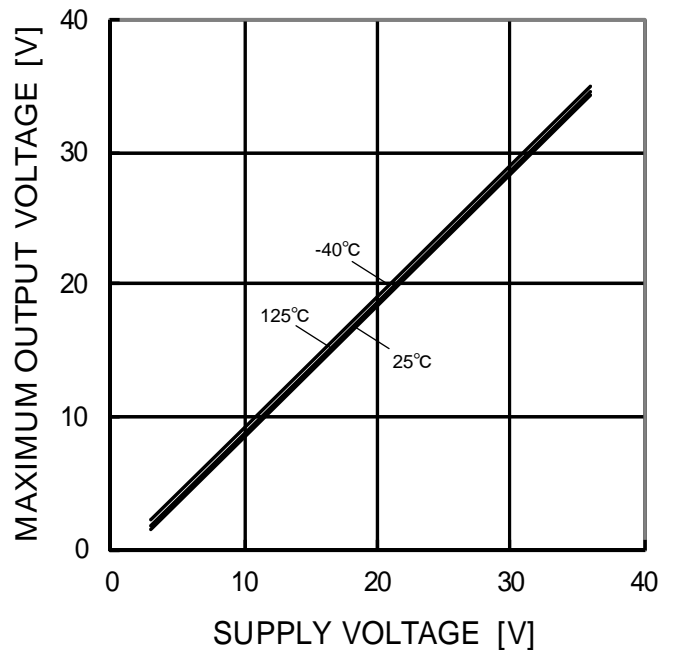

Figure 5.  
Maximum Output Voltage – Supply Voltage  
( $R_L=10k\Omega$ )

(\*)The above data is measurement value of typical sample, it is not guaranteed.

● Typical Performance Curves -Continued  
OBA2904Yxxx-C

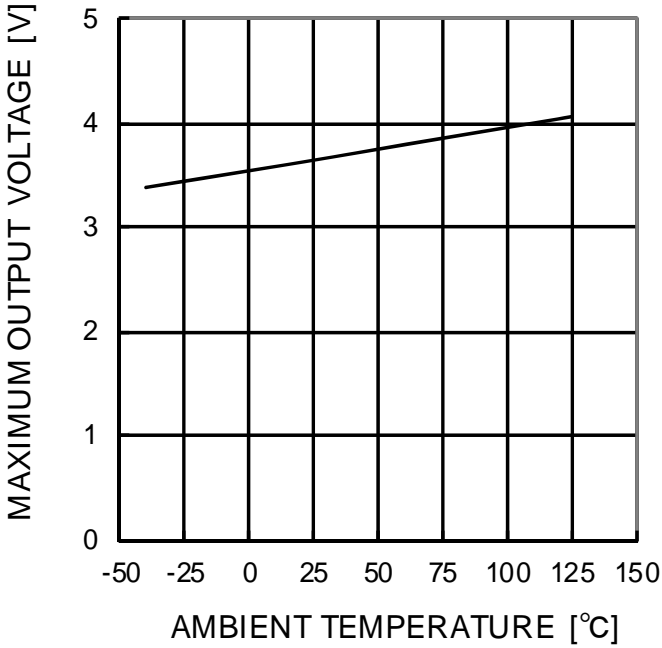

Figure 6.  
Maximum Output Voltage – Ambient Temperature  
(VCC=5V, RL=2kΩ)

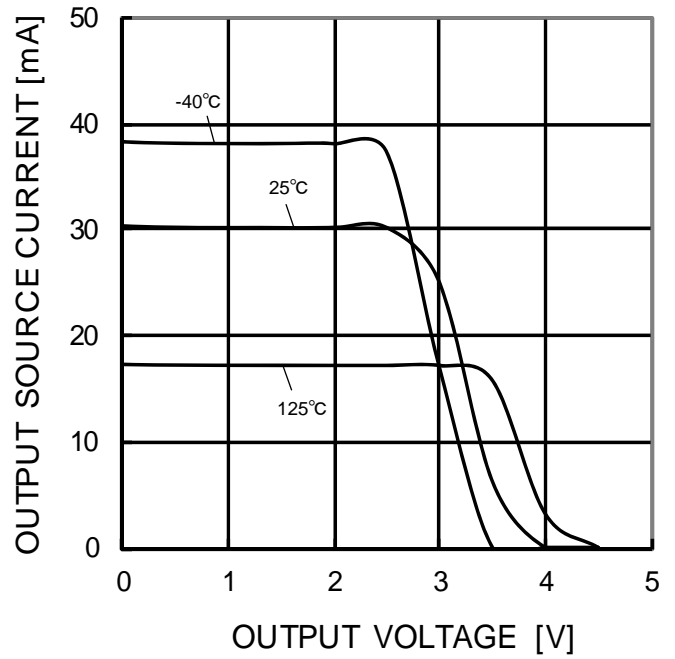

Figure 7.  
Output Source Current – Output Voltage  
(VCC=5V)

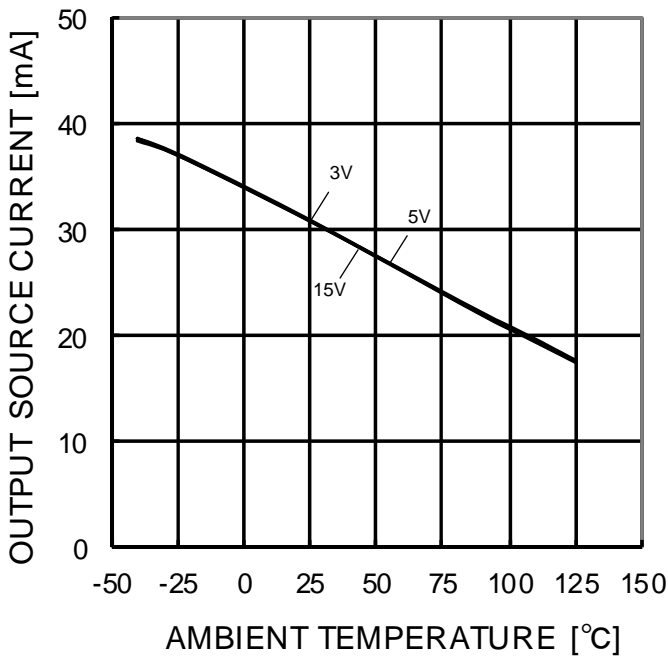

Figure 8.  
Output Source Current – Ambient Temperature  
(OUT=0V)

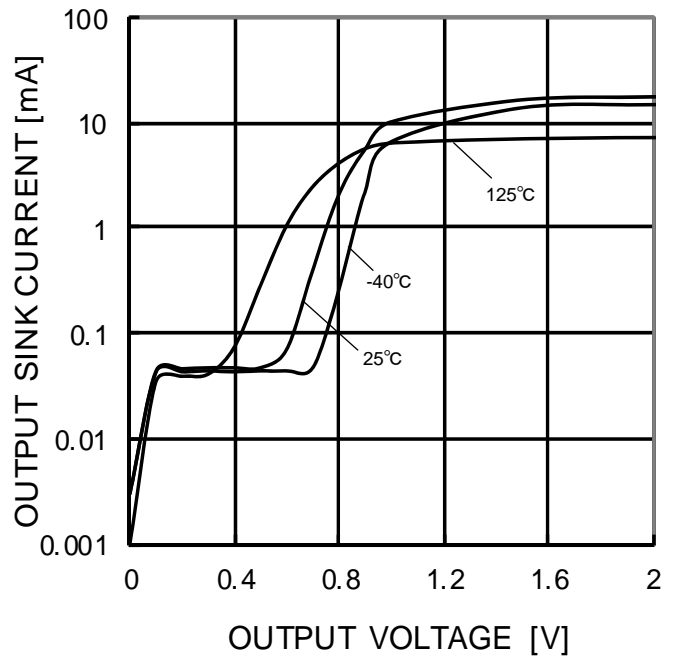

Figure 9.  
Output Sink Current – Output Voltage  
(VCC=5V)

(\*)The above data is measurement value of typical sample, it is not guaranteed.

● Typical Performance Curves -Continued  
OBA2904Yxxx-C

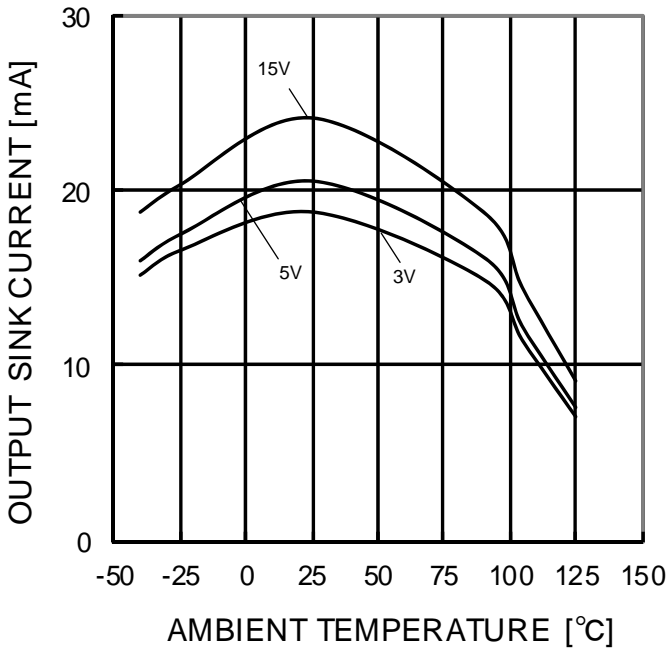

Figure 10.  
Output Sink Current – Ambient Temperature  
(OUT=VCC)

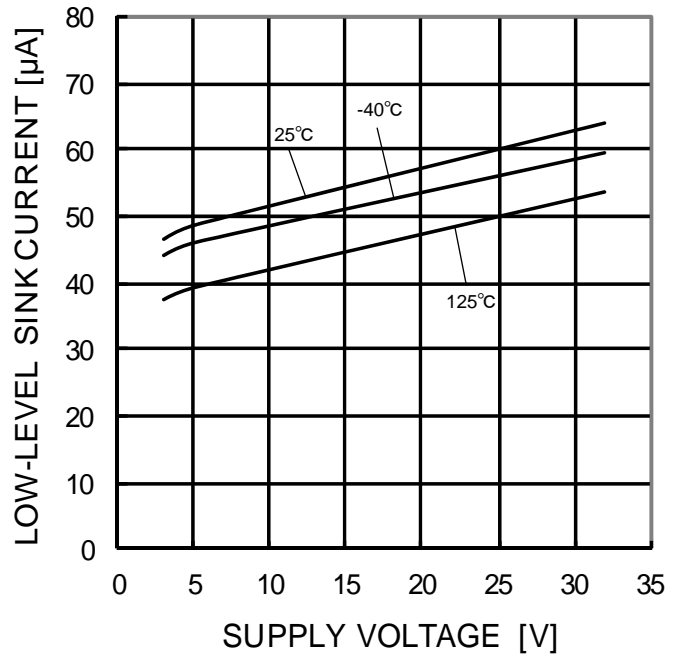

Figure 11.  
Low Level Sink Current – Supply Voltage  
(OUT=0.2V)

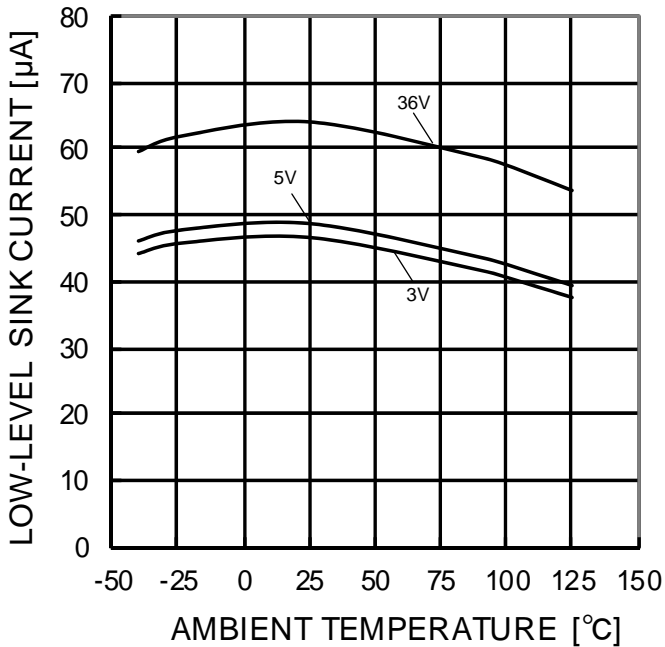

Figure 12.  
Low Level Sink Current – Ambient Temperature  
(OUT=0.2V)

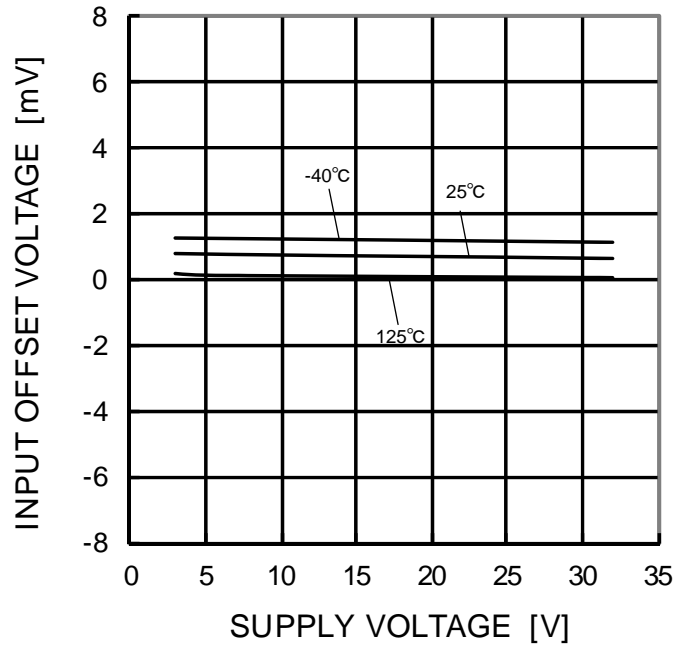

Figure 13.  
Input Offset Voltage – Supply Voltage  
(V<sub>icm</sub>=0V, OUT=1.4V)

(\*)The above data is measurement value of typical sample, it is not guaranteed.

● Typical Performance Curves -Continued

OBA2904Yxxx-C

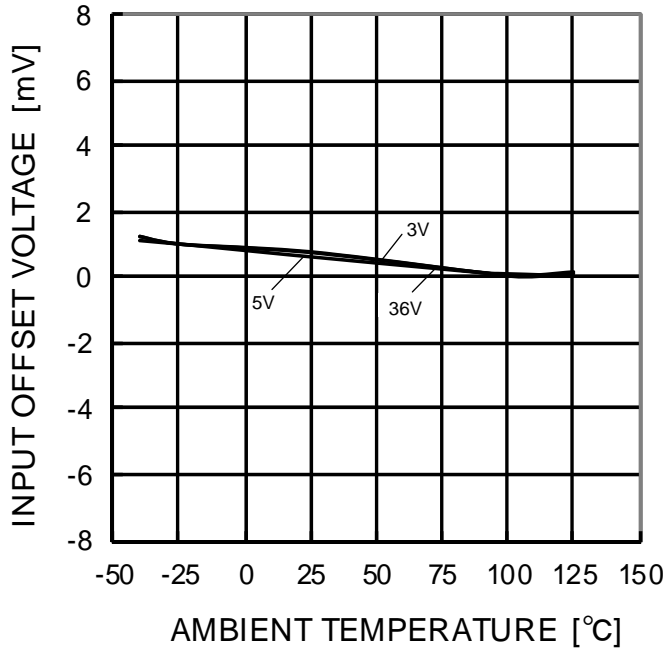

Figure 14.  
Input Offset Voltage – Ambient Temperature  
(Vicm=0V, OUT=1.4V)

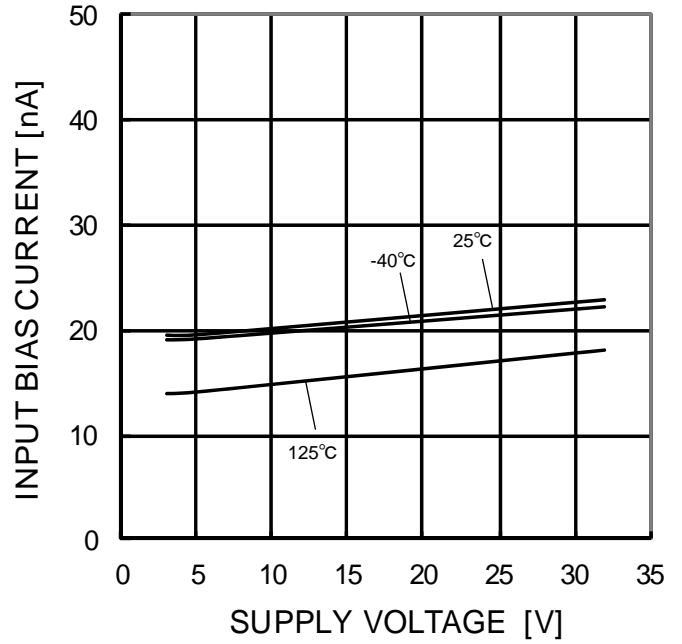

Figure 15.  
Input Bias Current – Supply Voltage  
(Vicm=0V, OUT=1.4V)

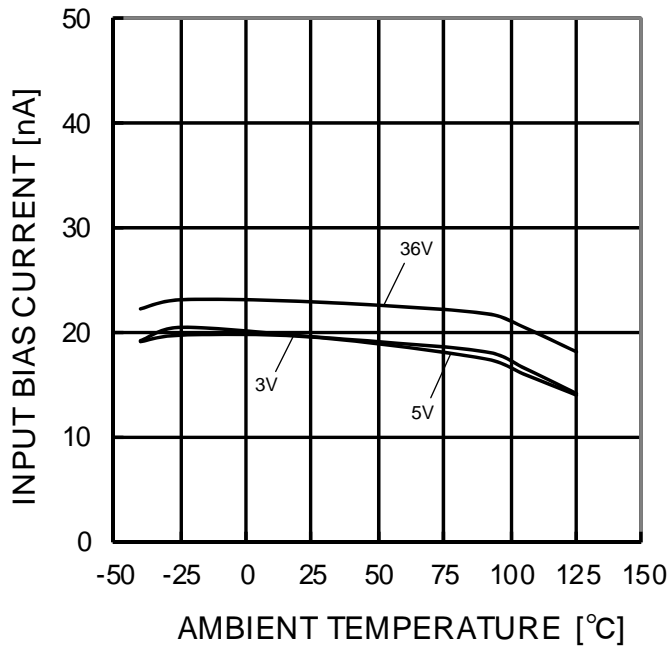

Figure 16.  
Input Bias Current – Ambient Temperature  
(Vicm=0V, OUT=1.4V)

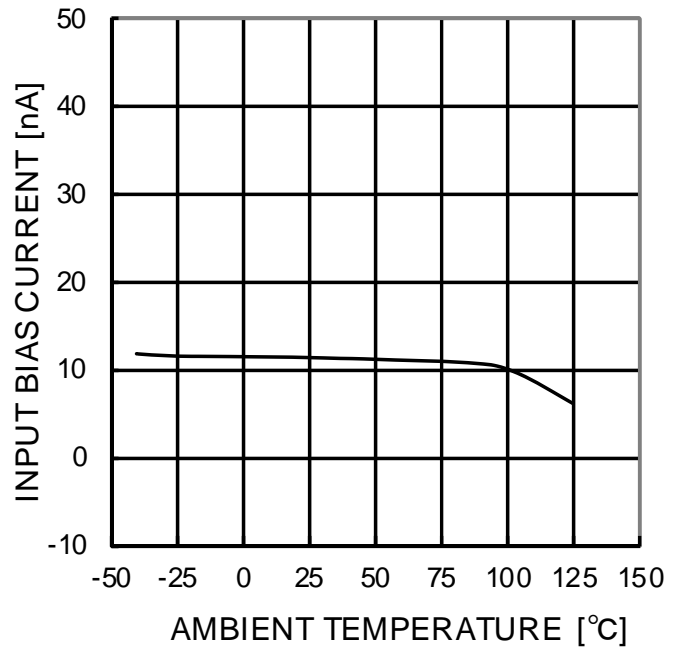

Figure 17.  
Input Bias Current – Ambient Temperature  
(VCC=30V, Vicm=28V, OUT=1.4V)

(\*)The above data is measurement value of typical sample, it is not guaranteed.

● Typical Performance Curves -Continued  
OBA2904Yxxx-C

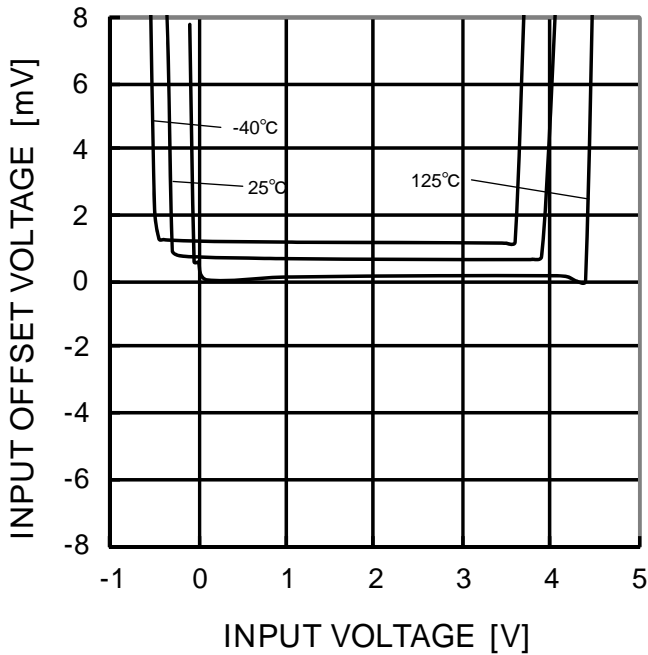

Figure 18.  
Input Offset Voltage – Input Voltage  
(VCC=5V)

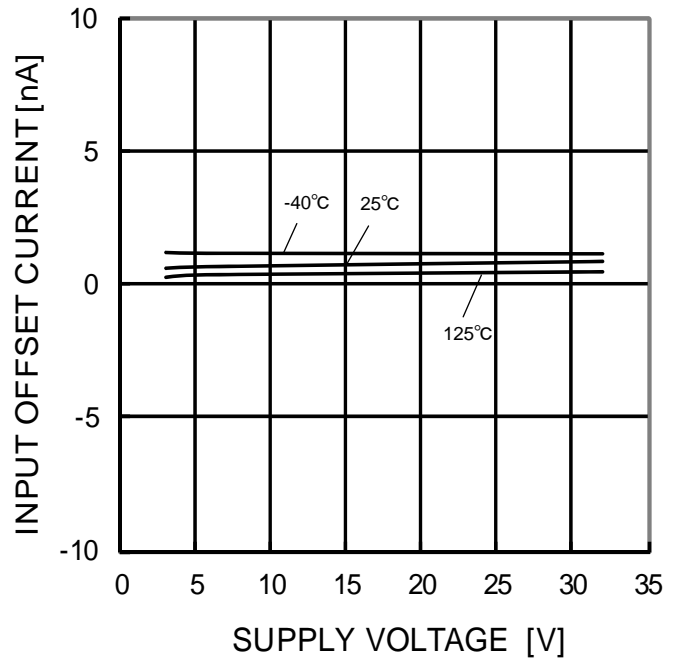

Figure 19.  
Input Offset Current – Supply Voltage  
(Vicm=0V, OUT=1.4V)

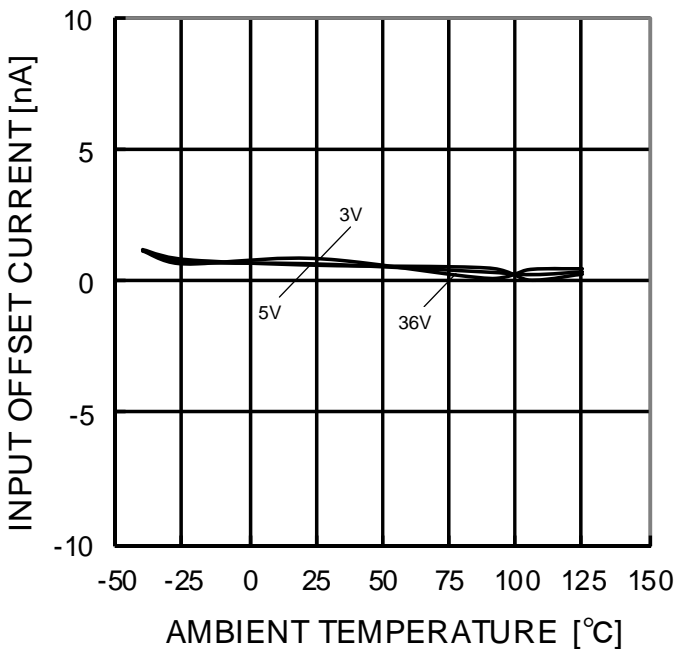

Figure 20.  
Input Offset Current – Ambient Temperature  
(Vicm=0V, OUT=1.4V)

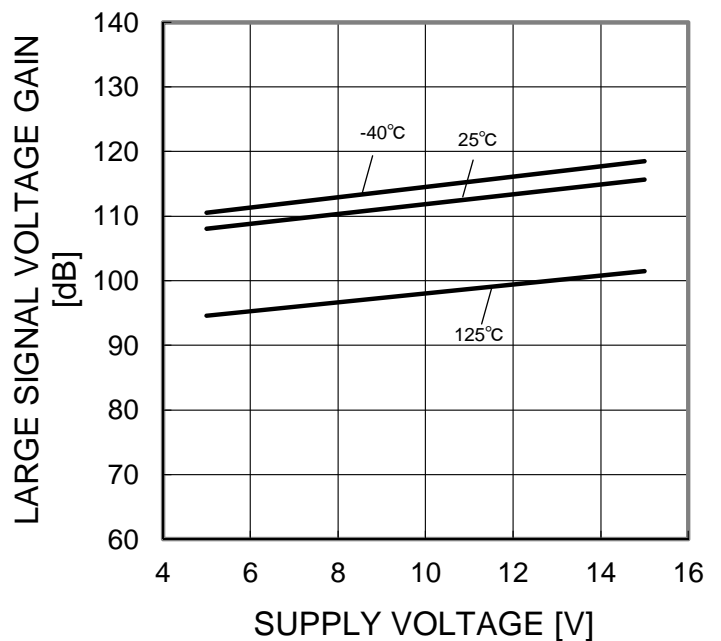

Figure 21.  
Large Signal Voltage Gain – Supply Voltage  
(RL=2kΩ)

(\*)The above data is measurement value of typical sample, it is not guaranteed.

● Typical Performance Curves -Continued  
OBA2904Yxxx-C

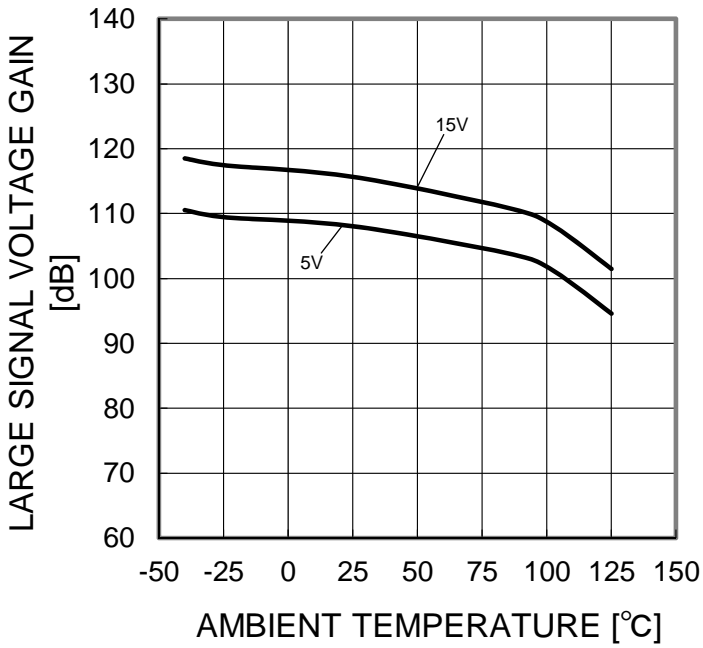

Figure 22.  
Large Signal Voltage Gain – Ambient Temperature  
(RL=2kΩ)

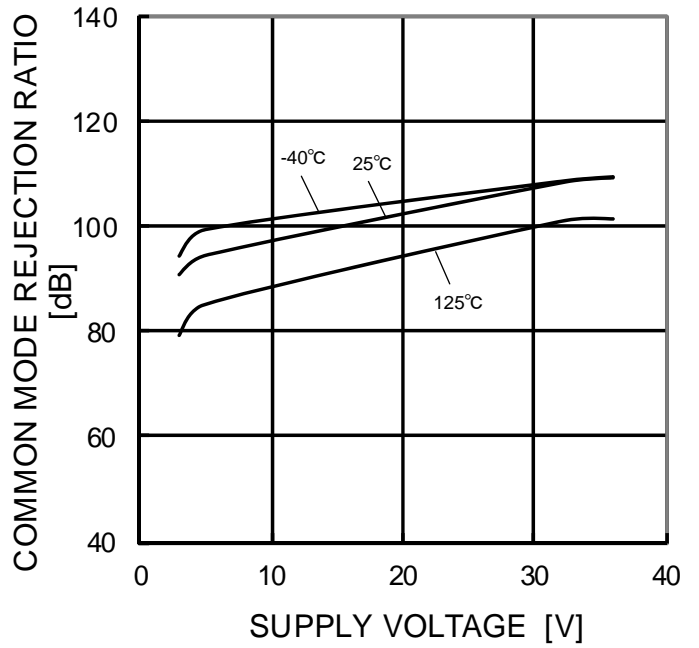

Figure 23.  
Common Mode Rejection Ratio  
– Supply Voltage

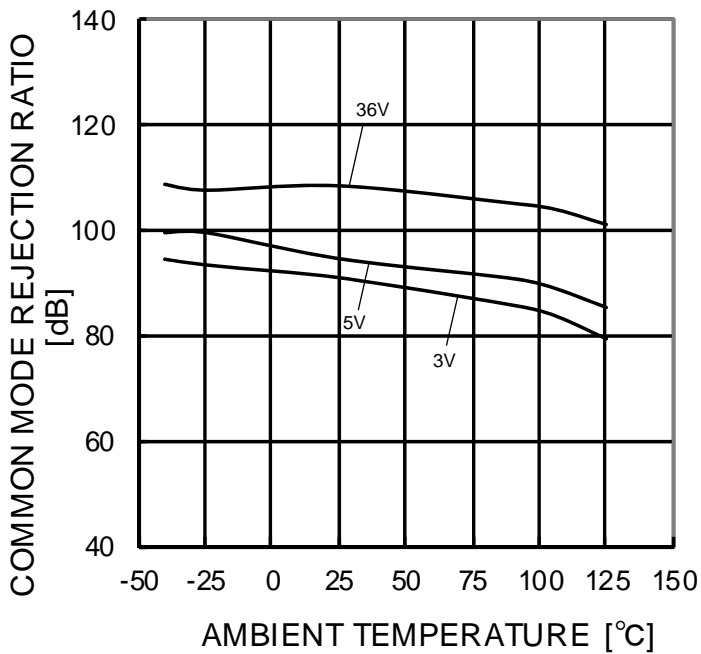

Figure 24.  
Common Mode Rejection Ratio  
– Ambient Temperature

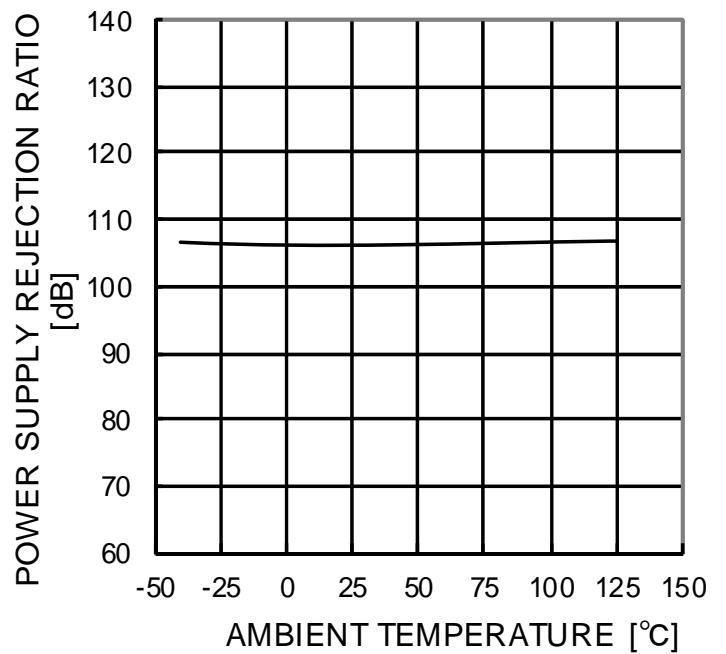

Figure 25.  
Power Supply Rejection Ratio  
– Ambient Temperature

(\*)The above data is measurement value of typical sample, it is not guaranteed.

● Typical Performance Curves

OBA2902Yxx-C

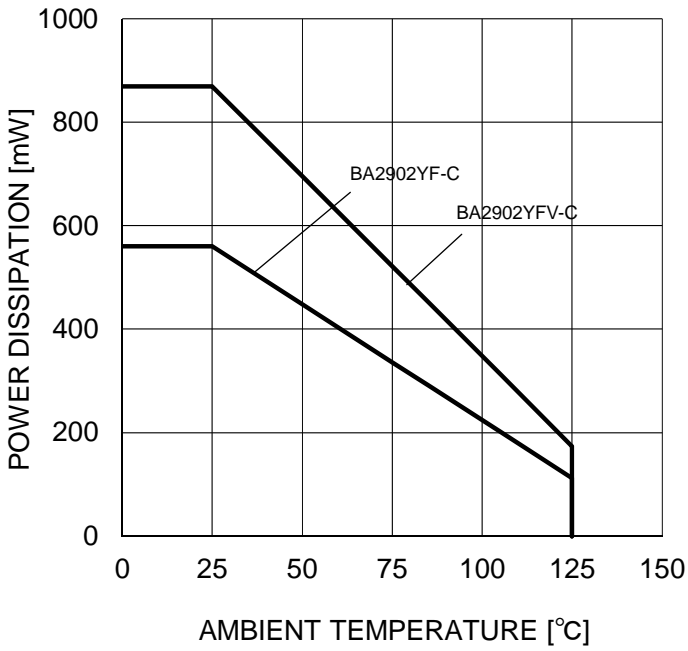

Figure 26.  
Derating Curve

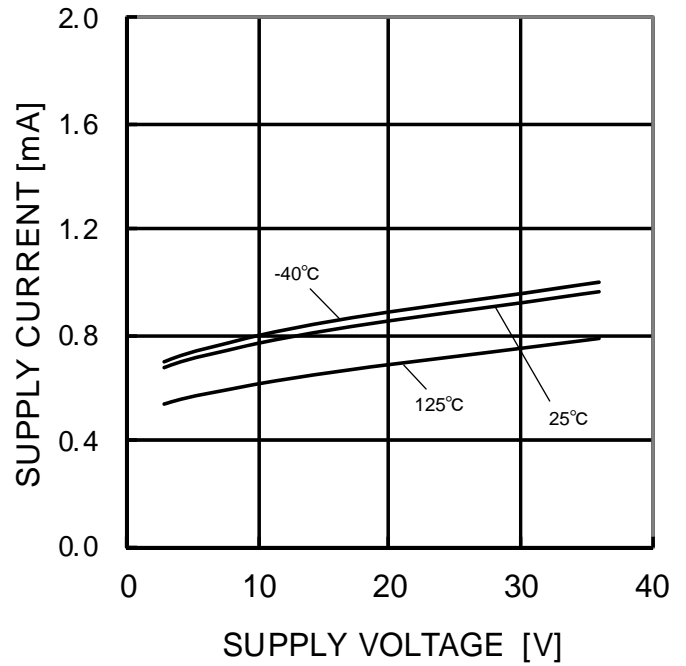

Figure 27.  
Supply Current – Supply Voltage

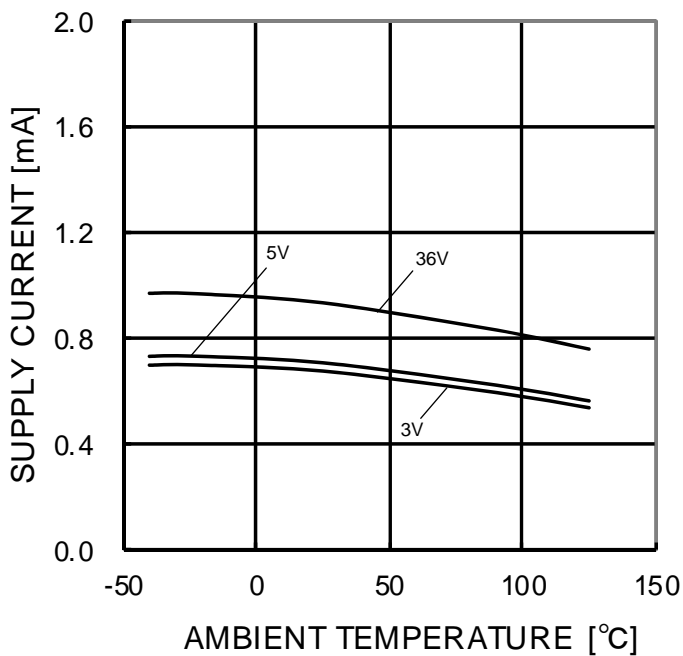

Figure 28.  
Supply Current – Ambient Temperature

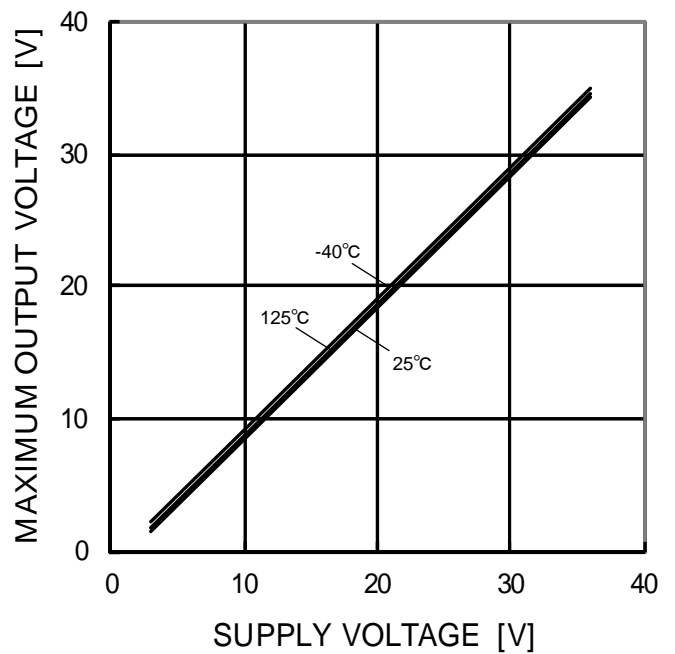

Figure 29.  
Maximum Output Voltage – Supply Voltage  
(RL=10kΩ)

(\*)The above data is measurement value of typical sample, it is not guaranteed.

● Typical Performance Curves -Continued  
OBA2902Yxx-C

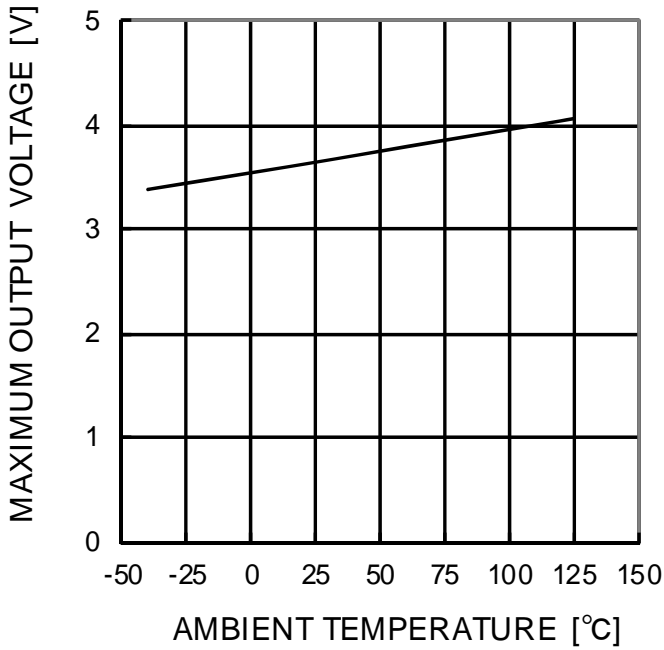

Figure 30.  
Maximum Output Voltage – Ambient Temperature  
(VCC=5V, RL=2kΩ)

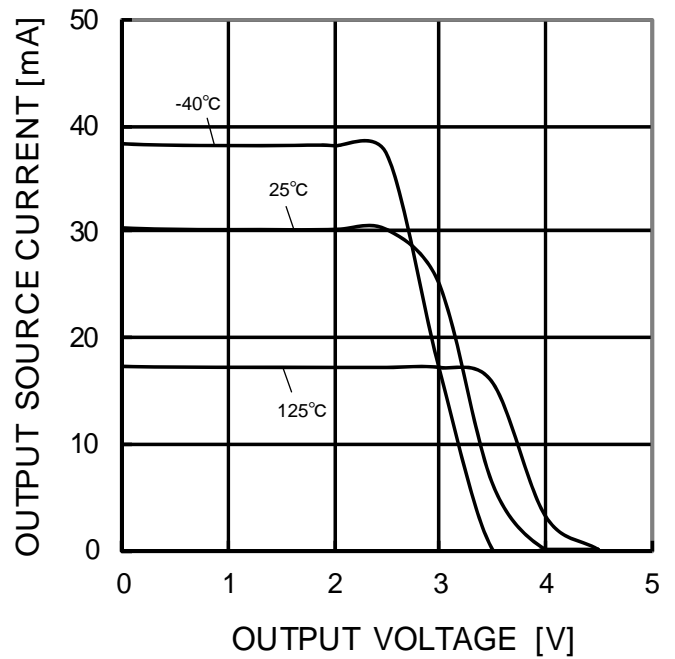

Figure 31.  
Output Source Current – Output Voltage  
(VCC=5V)

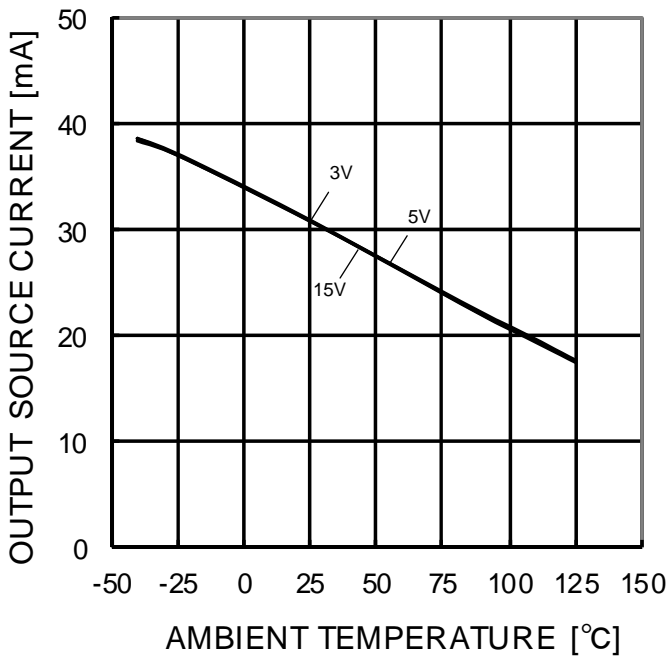

Figure 32.  
Output Source Current – Ambient Temperature  
(OUT=0V)

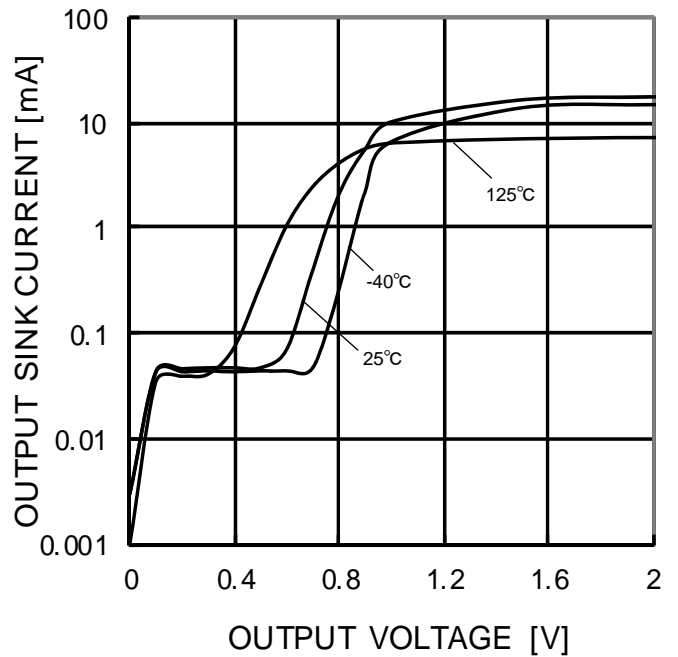

Figure 33.  
Output Sink Current – Output Voltage  
(VCC=5V)

(\*)The above data is measurement value of typical sample, it is not guaranteed.

● Typical Performance Curves -Continued  
OBA2902Yxx-C

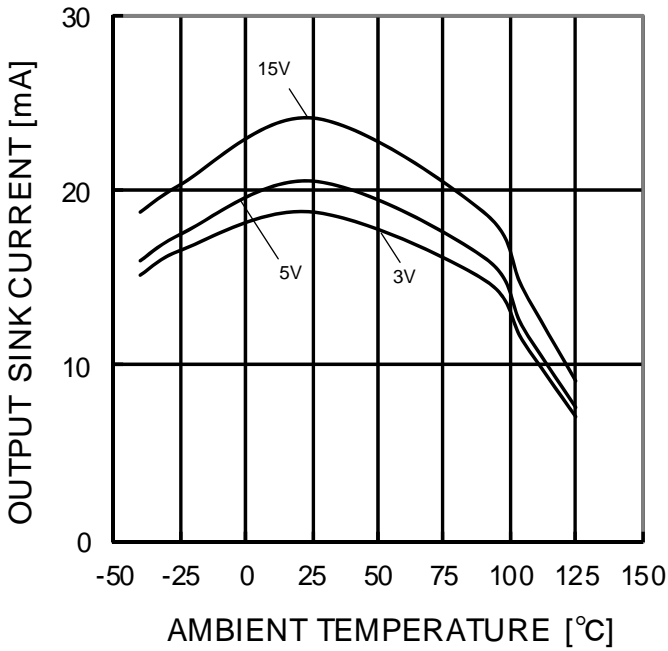

Figure 34.  
Output Sink Current – Ambient Temperature  
(OUT=VCC)

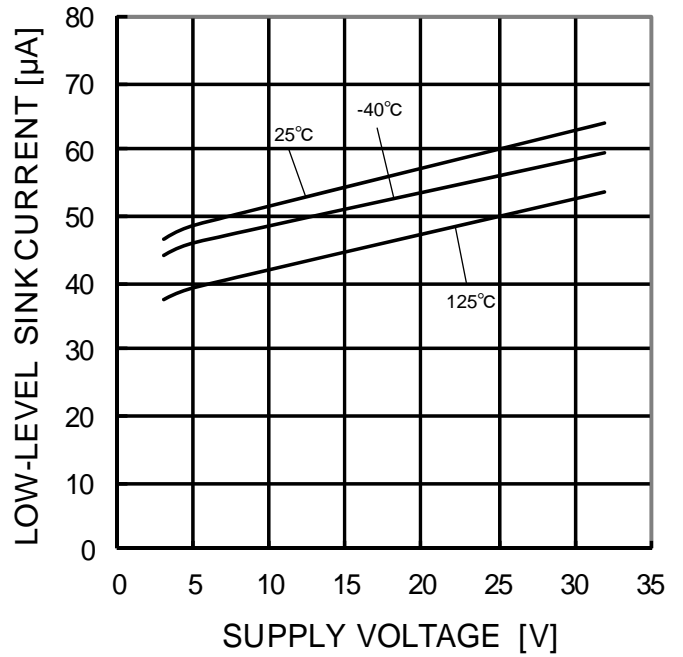

Figure 35.  
Low Level Sink Current – Supply Voltage  
(OUT=0.2V)

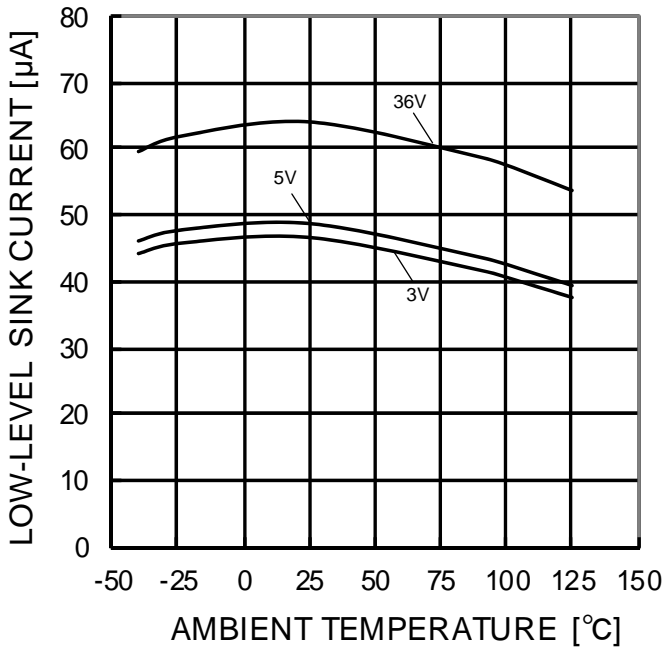

Figure 36.  
Low Level Sink Current – Ambient Temperature  
(OUT=0.2V)

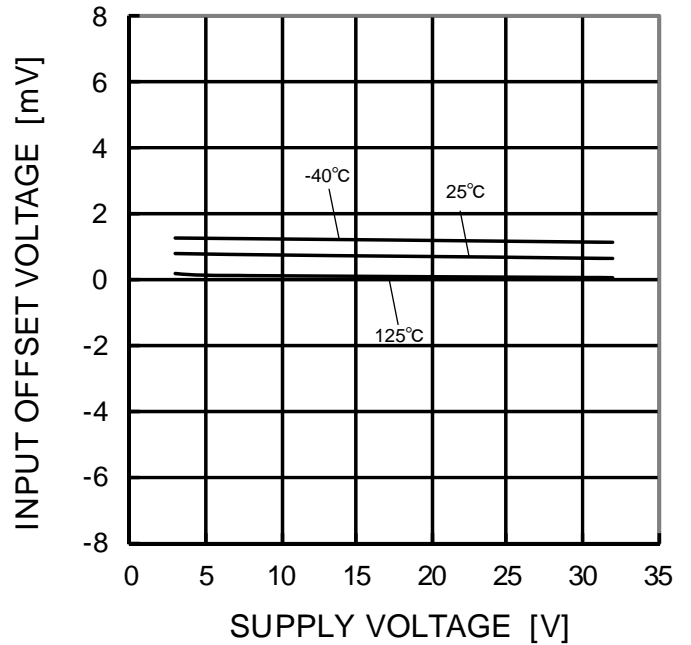

Figure 37.  
Input Offset Voltage – Supply Voltage  
(V<sub>icm</sub>=0V, OUT=1.4V)

(\*)The above data is measurement value of typical sample, it is not guaranteed.

● Typical Performance Curves -Continued  
OBA2902Yxx-C

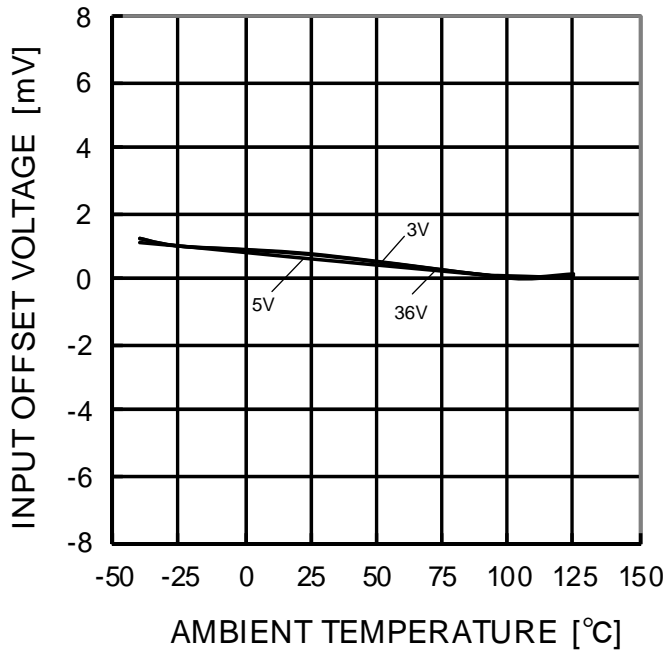

Figure 38.  
Input Offset Voltage – Ambient Temperature  
(Vicm=0V, OUT=1.4V)

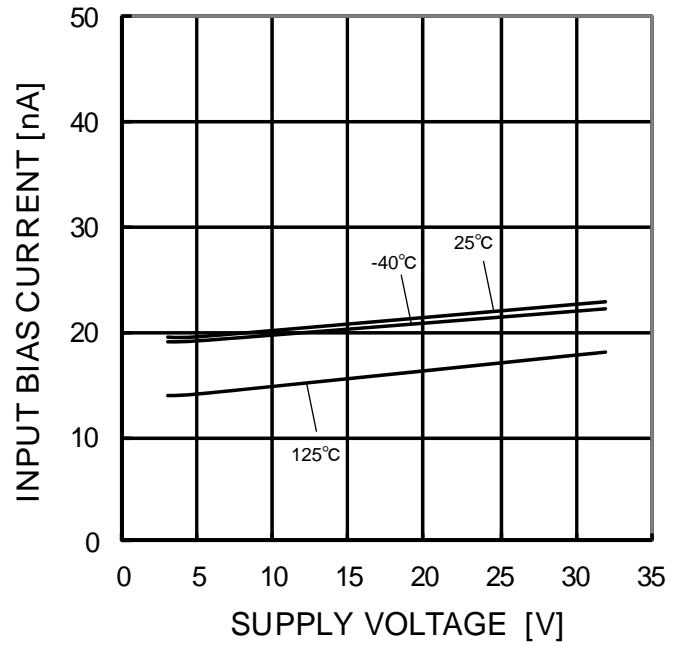

Figure 39.  
Input Bias Current – Supply Voltage  
(Vicm=0V, OUT=1.4V)

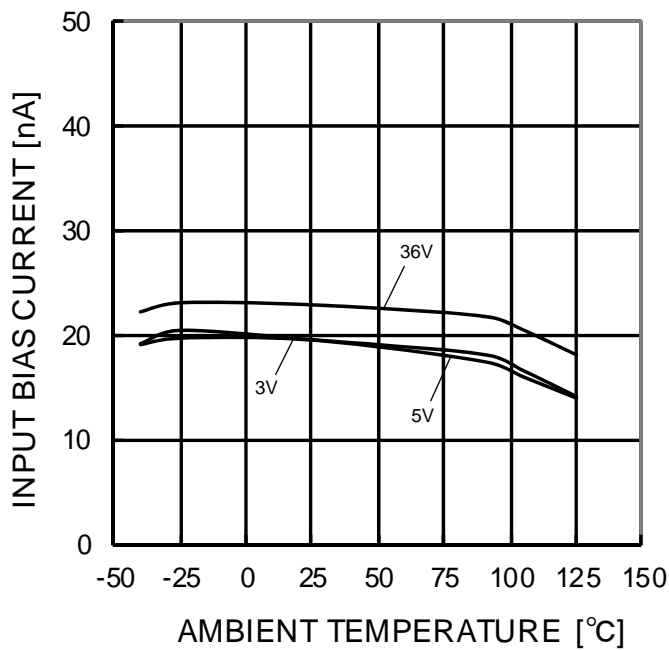

Figure 40.  
Input Bias Current – Ambient Temperature  
(Vicm=0V, OUT=1.4V)

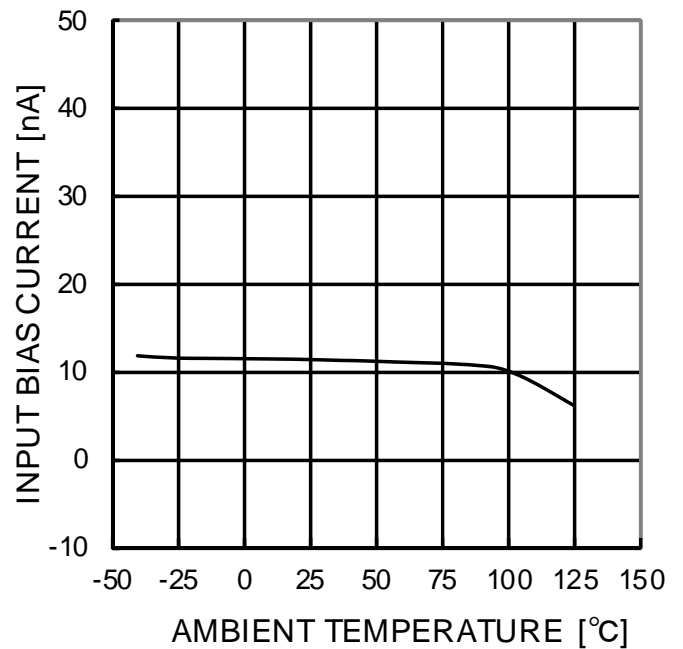

Figure 41.  
Input Bias Current – Ambient Temperature  
(VCC=30V, Vicm=28V, OUT=1.4V)

(\*)The above data is measurement value of typical sample, it is not guaranteed.

● Typical Performance Curves -Continued  
OBA2902Yxx-C

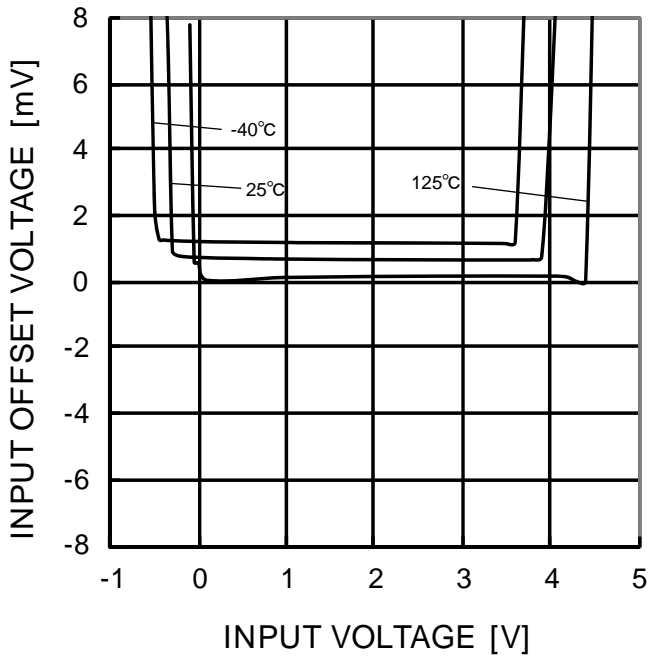

Figure 42.  
Input Offset Voltage – Input Voltage  
(VCC=5V)

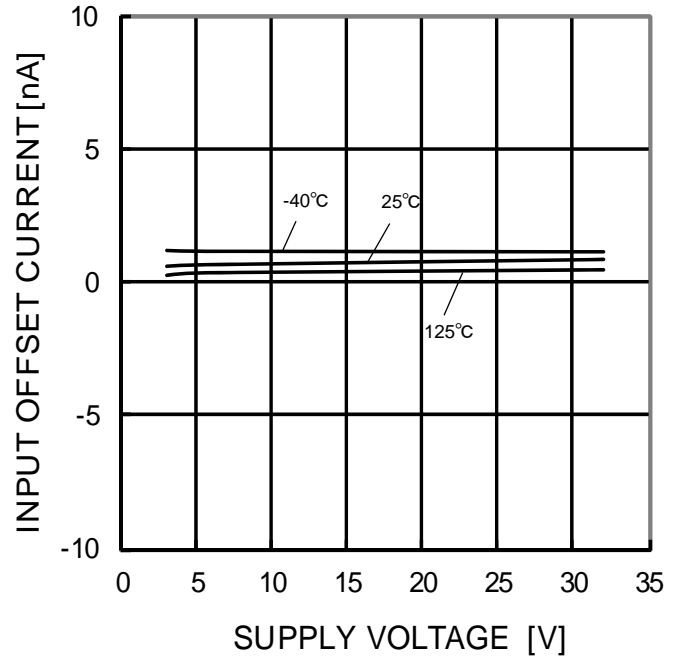

Figure 43.  
Input Offset Current – Supply Voltage  
(Vicm=0V, OUT=1.4V)

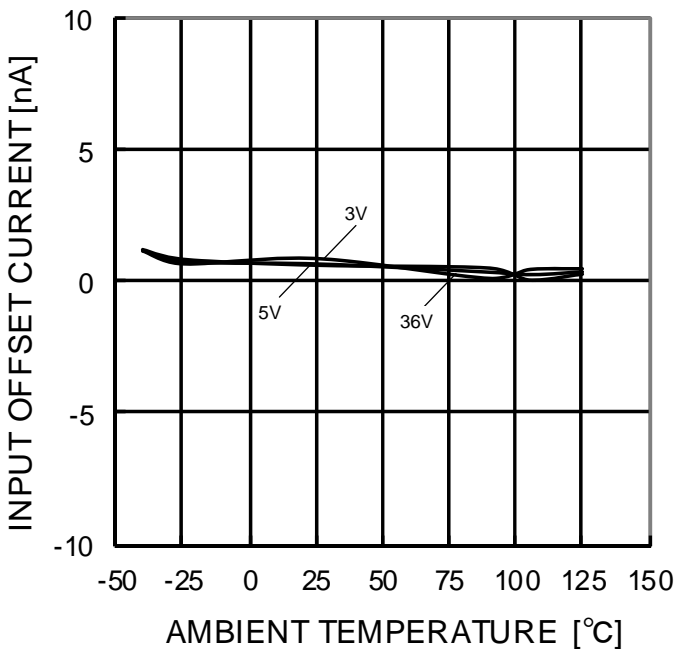

Figure 44.  
Input Offset Current – Ambient Temperature  
(Vicm=0V, OUT=1.4V)

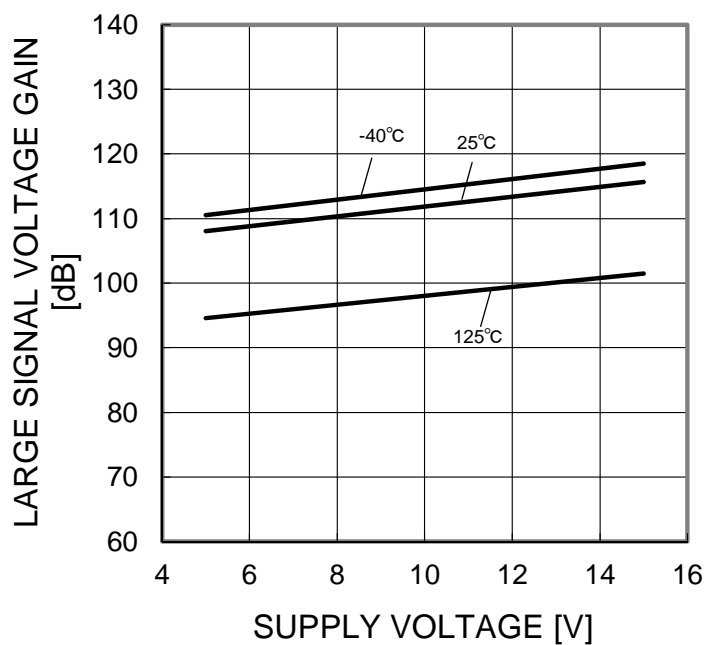

Figure 45.  
Large Signal Voltage Gain – Supply Voltage  
(RL=2kΩ)

(\*)The above data is measurement value of typical sample, it is not guaranteed.

● Typical Performance Curves -Continued  
OBA2902Yxx-C

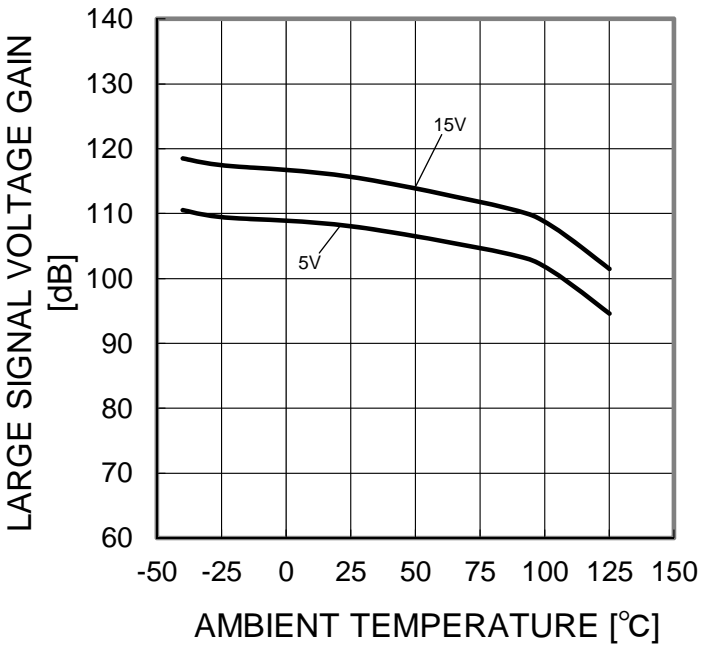

Figure 46.  
Large Signal Voltage Gain – Ambient Temperature  
(RL=2kΩ)

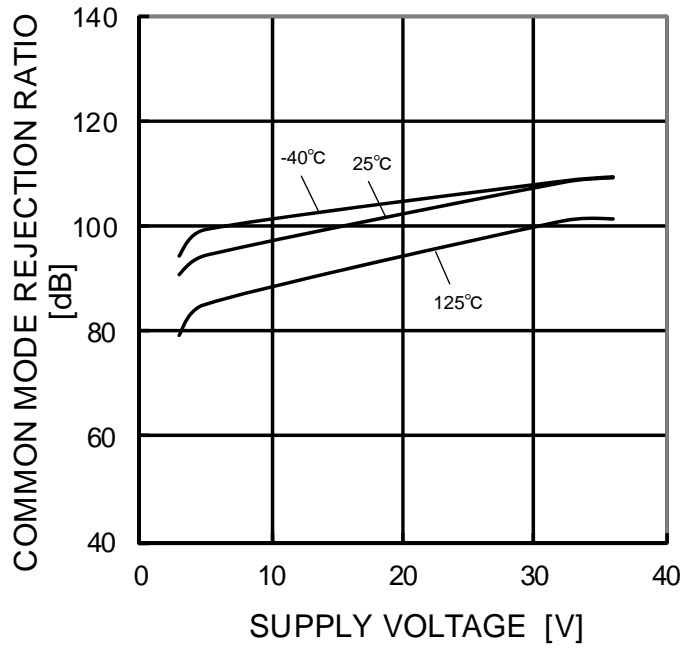

Figure 47.  
Common Mode Rejection Ratio  
– Supply Voltage

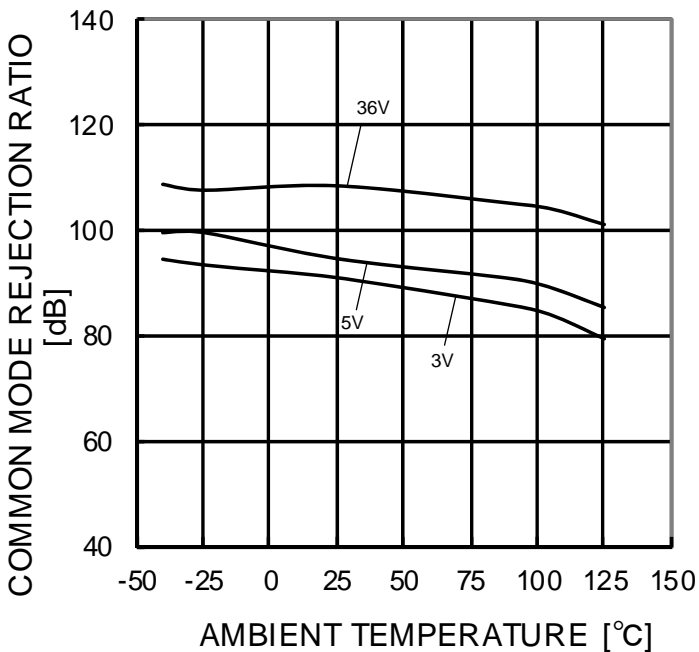

Figure 48.  
Common Mode Rejection Ratio  
– Ambient Temperature

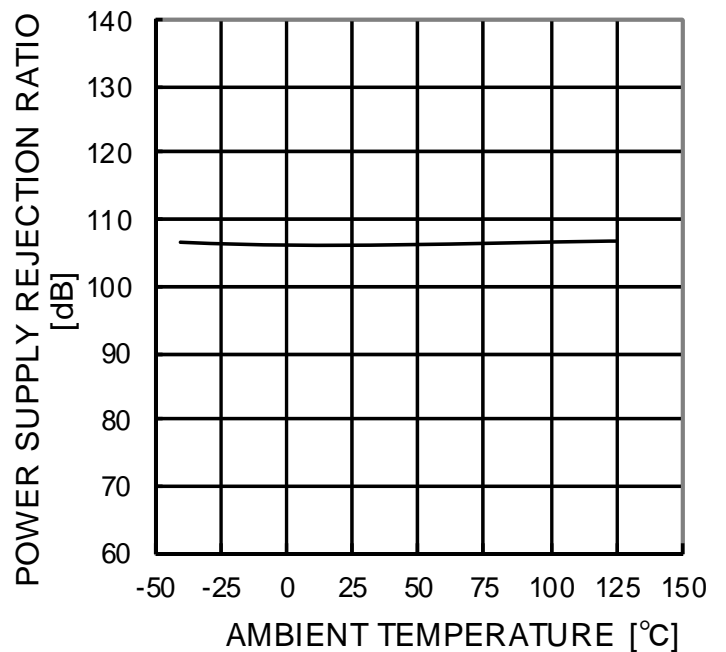

Figure 49.  
Power Supply Rejection Ratio  
– Ambient Temperature

(\*)The above data is measurement value of typical sample, it is not guaranteed.

● Power Dissipation

Power dissipation (total loss) indicates the power that the IC can consume at Ta=25°C (normal temperature). As the IC consumes power, it heats up, causing its temperature to be higher than the ambient temperature. The allowable temperature that the IC can accept is limited. This depends on the circuit configuration, manufacturing process, and consumable power.

Power dissipation is determined by the allowable temperature within the IC (maximum junction temperature) and the thermal resistance of the package used (heat dissipation capability). Maximum junction temperature is typically equal to the maximum storage temperature. The heat generated through the consumption of power by the IC radiates from the mold resin or lead frame of the package. Thermal resistance, represented by the symbol θja°C/W, indicates this heat dissipation capability. Similarly, the temperature of an IC inside its package can be estimated by thermal resistance.

Figure 50. (a) shows the model of the thermal resistance of the package. The equation below shows how to compute for the Thermal resistance (θja), given the ambient temperature (Ta), junction temperature (Tj), and power dissipation (Pd).

$$\theta_{ja} = (T_{jmax} - T_a) / P_d \quad \text{°C/W} \quad \dots \dots \dots (I)$$

The Derating curve in Figure 50. (b) indicates the power that the IC can consume with reference to ambient temperature. Power consumption of the IC begins to attenuate at certain temperatures. This gradient is determined by Thermal resistance (θja), which depends on the chip size, power consumption, package, ambient temperature, package condition, wind velocity, etc. This may also vary even when the same of package is used. Thermal reduction curve indicates a reference value measured at a specified condition. Figure 51. (c),(d) shows an example of the derating curve for BA2904Yxxx-C, BA2902Yxx-C.

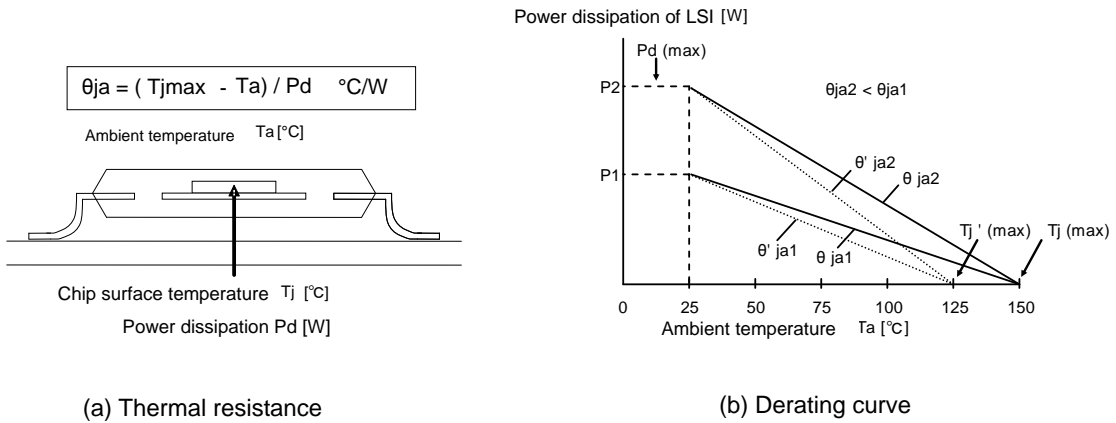
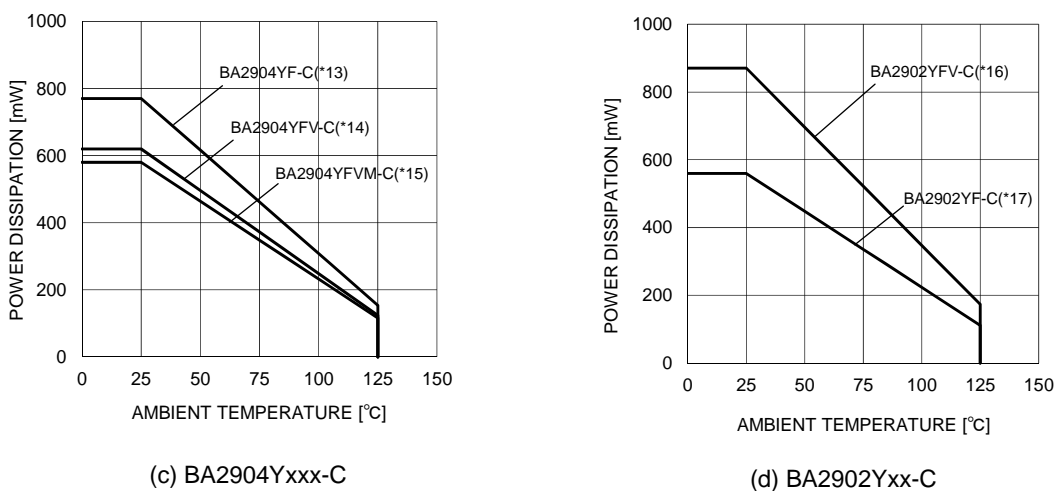

Figure 50. Thermal resistance and derating



| (*13) | (*14) | (*15) | (*16) | (*17) | Unit  |
|-------|-------|-------|-------|-------|-------|
| 6.2   | 5.0   | 4.7   | 7.0   | 4.5   | mW/°C |

When using the unit above Ta=25°C, subtract the value above per Celsius degree .  
 Mounted on a FR4 glass epoxy board 70mm×70mm×1.6mm(cooper foil area below 3%)

Figure 51. Derating curve



Test Circuit 2 Switch Condition

| SW No.                         | SW 1 | SW 2 | SW 3 | SW 4 | SW 5 | SW 6 | SW 7 | SW 8 | SW 9 | SW 10 | SW 11 | SW 12 | SW 13 | SW 14 |
|--------------------------------|------|------|------|------|------|------|------|------|------|-------|-------|-------|-------|-------|
| Supply Current                 | OFF  | OFF  | OFF  | ON   | OFF  | ON   | OFF  | OFF  | OFF  | OFF   | OFF   | OFF   | OFF   | OFF   |
| Maximum Output Voltage (high)  | OFF  | OFF  | ON   | OFF  | OFF  | ON   | OFF  | OFF  | ON   | OFF   | OFF   | OFF   | ON    | OFF   |
| Maximum Output Voltage (Low)   | OFF  | OFF  | ON   | OFF  | OFF  | ON   | OFF  | OFF  | ON   | OFF   | OFF   | OFF   | ON    | OFF   |
| Output Source Current          | OFF  | OFF  | ON   | OFF  | OFF  | ON   | OFF  | OFF  | OFF  | OFF   | OFF   | OFF   | OFF   | ON    |
| Output Sink Current            | OFF  | OFF  | ON   | OFF  | OFF  | ON   | OFF  | OFF  | OFF  | OFF   | OFF   | OFF   | OFF   | ON    |
| Slew Rate                      | OFF  | OFF  | OFF  | ON   | OFF  | OFF  | OFF  | ON   | ON   | ON    | ON    | OFF   | OFF   | OFF   |
| Gain Bandwidth Product         | OFF  | ON   | OFF  | OFF  | ON   | ON   | OFF  | OFF  | ON   | ON    | ON    | OFF   | OFF   | OFF   |
| Equivalent Input Noise Voltage | ON   | OFF  | OFF  | OFF  | ON   | ON   | OFF  | OFF  | OFF  | OFF   | ON    | OFF   | OFF   | OFF   |

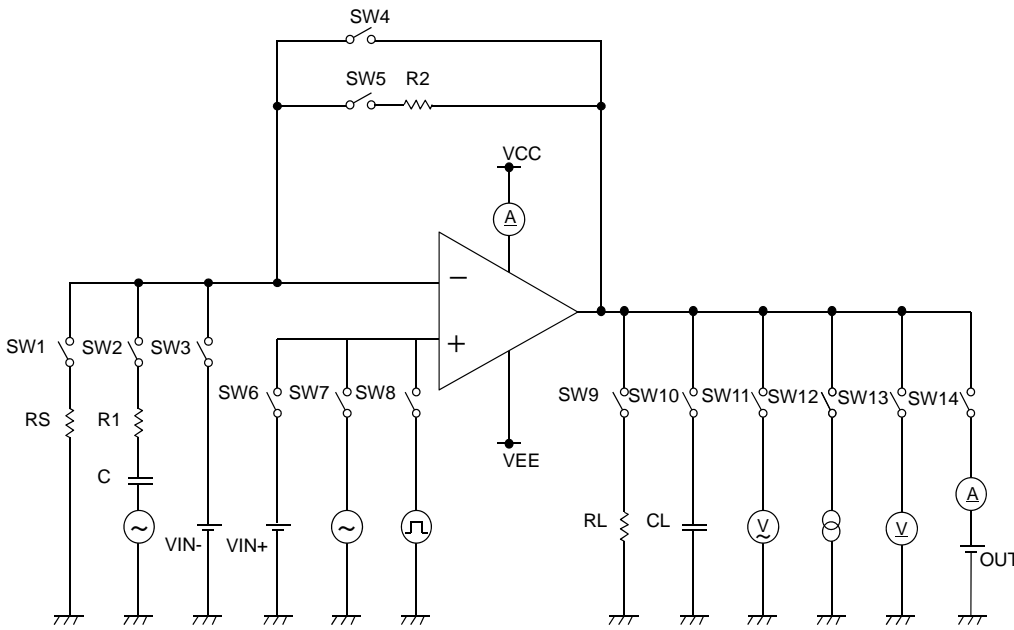

Figure . 53 Test Circuit 2 (each Op-Amp)

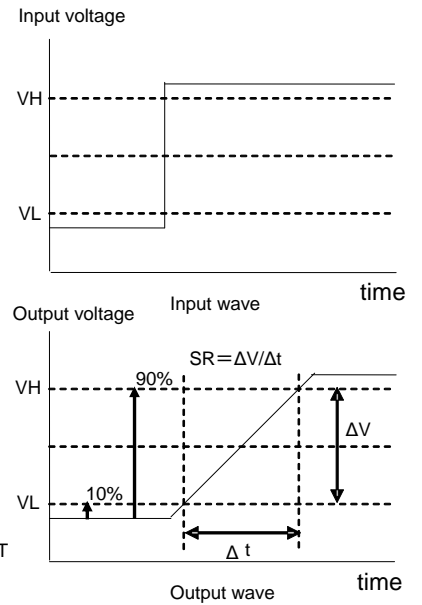

Figure . 54 Slew Rate Input Waveform

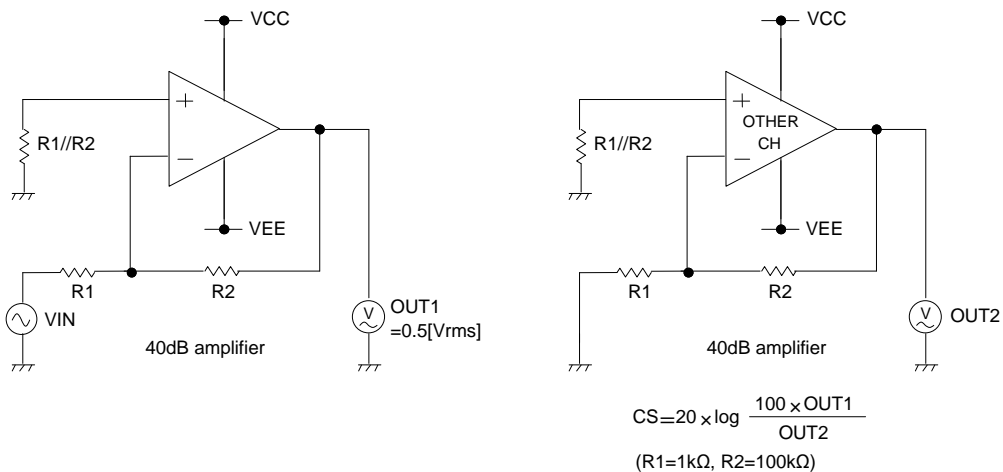

Figure . 55 Test Circuit 3(Channel Separation)

### ●Operational Notes

- 1) Unused circuits  
When there are unused circuits, it is recommended that they are connected as in Figure .56, setting the non-inverting input terminal to a potential within the in-phase input voltage range ( $V_{icm}$ ).
- 2) Input voltage  
Applying VEE +36V to the input terminal is possible without causing deterioration of the electrical characteristics or destruction, regardless of the supply voltage. However, this does not ensure normal circuit operation. Please note that the circuit operates normally only when the input voltage is within the common mode input voltage range of the electric characteristics.
- 3) Power supply (single / dual)  
The op-amp operates when the voltage supplied is between VCC and VEE. Therefore, the single supply op-amp can be used as dual supply op-amp as well.
- 4) Power Dissipation (Pd)  
Using the unit in excess of the rated power dissipation may cause deterioration in electrical characteristics including reduced current capability due to the rise of chip temperature. Therefore, please take into consideration the power dissipation (Pd) under actual operating conditions and apply a sufficient margin in thermal design. Refer to the thermal derating curves for more information.
- 5) Short-circuit between pins and erroneous mounting  
Be careful when mounting the IC on printed circuit boards. The IC may be damaged if it is mounted in a wrong orientation or if pins are shorted together. Short circuit may be caused by conductive particles caught between the pins.
- 6) Operation in a strong electromagnetic field  
Operating the IC in the presence of a strong electromagnetic field may cause the IC to malfunction.
- 7) Radioactive rays  
This IC is not designed protection against radioactive rays.
- 8) IC handling  
Applying mechanical stress to the IC by deflecting or bending the board may cause fluctuations of the electrical characteristics due to piezo resistance effects.
- 9) IC operation  
The output stage of the IC is configured using Class C push-pull circuits. Therefore, when the load resistor is connected to the middle potential of VCC and VEE, crossover distortion occurs at the changeover between discharging and charging of the output current. Connecting a resistor between the output terminal and GND, and increasing the bias current for Class A operation will suppress crossover distortion.
- 10) Board inspection  
Connecting a capacitor to a pin with low impedance may stress the IC. Therefore, discharging the capacitor after every process is recommended. In addition, when attaching and detaching the jig during the inspection phase, make sure that the power is turned OFF before inspection and removal. Furthermore, please take measures against ESD in the assembly process as well as during transportation and storage.
- 11) Output capacitor  
If a large capacitor is connected between the output pin and VEE pin, current from the charged capacitor will flow into the output pin and may destroy the IC when the VCC pin is shorted to ground or pulled down to 0V. Use a capacitor smaller than 0.1 $\mu$ F between output pin and VEE pin.
- 12) Oscillation by output capacitor  
Please pay attention to the oscillation by output capacitor and in designing an application of negative feedback loop circuit with these ICs.

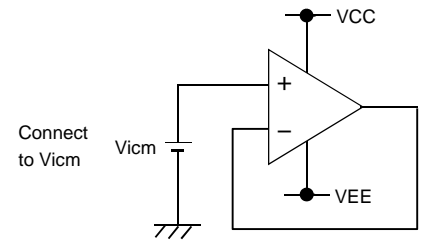
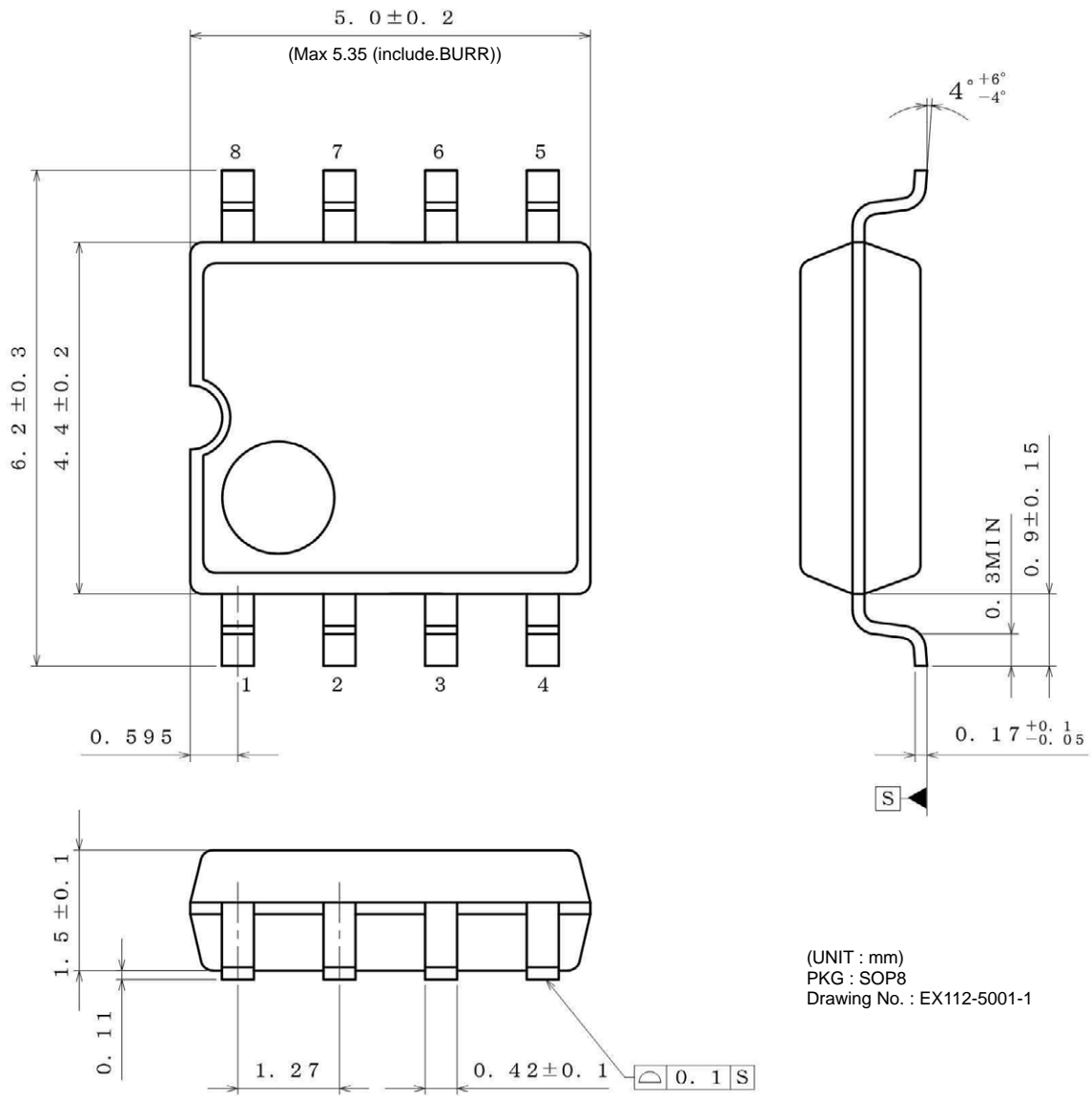

Figure 56. Example of application circuit for unused op-amp

●Physical Dimension, Tape and Reel Information

|              |      |
|--------------|------|
| Package Name | SOP8 |
|--------------|------|



(UNIT : mm)  
 PKG : SOP8  
 Drawing No. : EX112-5001-1

<Tape and Reel information>

|                   |   |
|-------------------|---|
| Tape              | Embossed carrier tape   |
| Quantity          | 2500pcs   |
| Direction of feed | E2<br>(The direction is the 1pin of product is at the upper left when you hold reel on the left hand and you pull out the tape on the right hand) |

Reel      1pin      Direction of feed

\*Order quantity needs to be multiple of the minimum quantity.

●Physical Dimension, Tape and Reel Information

|              |       |
|--------------|-------|
| Package Name | SOP14 |
|--------------|-------|

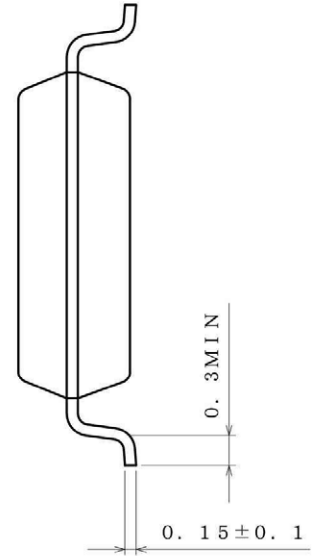
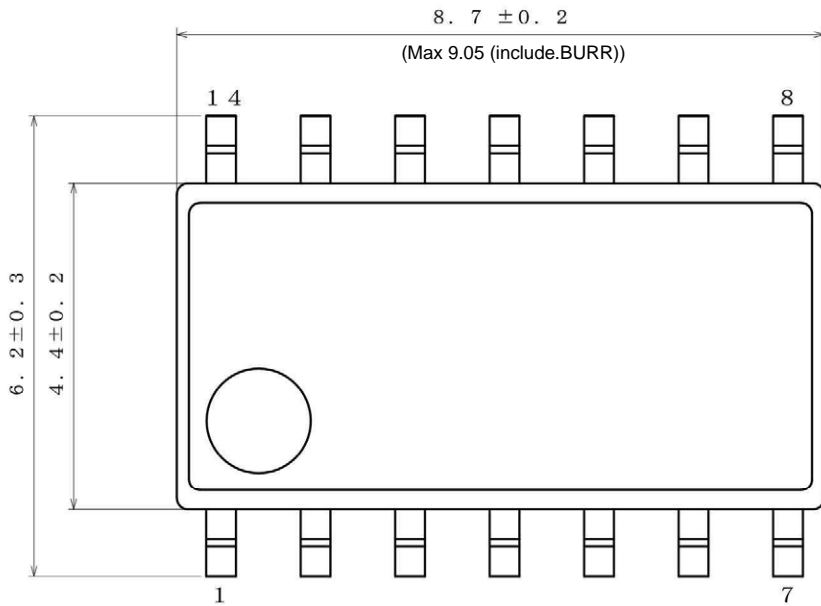

(UNIT : mm)  
 PKG : SOP14  
 Drawing No. : EX113-5001

<Tape and Reel information>

|                   |   |
|-------------------|---|
| Tape              | Embossed carrier tape   |
| Quantity          | 2500pcs   |
| Direction of feed | E2<br>( The direction is the 1pin of product is at the upper left when you hold reel on the left hand and you pull out the tape on the right hand ) |

1pin  
 \*Order quantity needs to be multiple of the minimum quantity.

●Physical Dimension, Tape and Reel Information

|              |         |
|--------------|---------|
| Package Name | SSOP-B8 |
|--------------|---------|

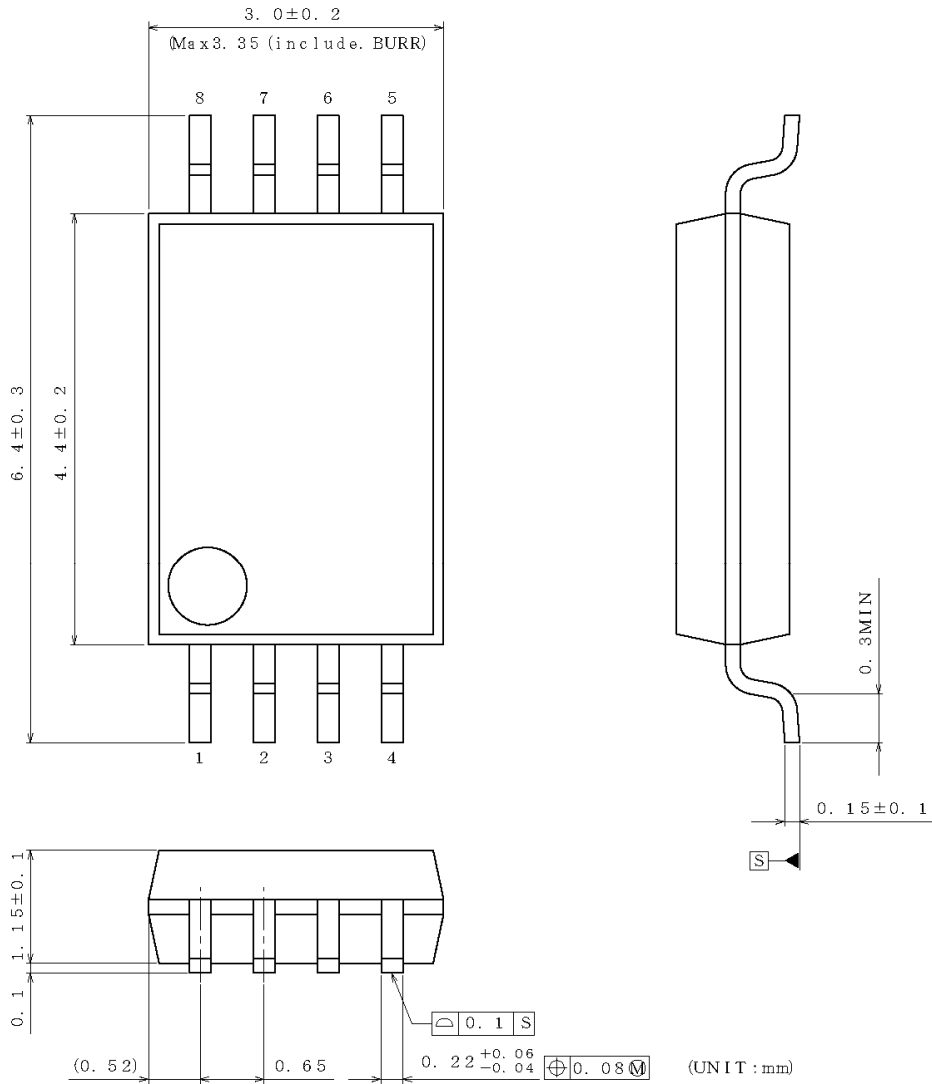

(UNIT : mm)  
 PKG : SSOP-B8  
 Drawing No. EX151-5002

<Tape and Reel information>

|                   |   |
|-------------------|---|
| Tape              | Embossed carrier tape   |
| Quantity          | 2500pcs   |
| Direction of feed | E2<br>( The direction is the 1pin of product is at the upper left when you hold reel on the left hand and you pull out the tape on the right hand ) |

Reel

1pin

Direction of feed

\* Order quantity needs to be multiple of the minimum quantity.

●Physical Dimension, Tape and Reel Information

|              |          |
|--------------|----------|
| Package Name | SSOP-B14 |
|--------------|----------|

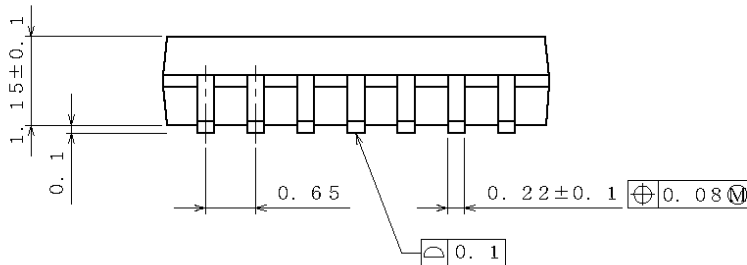
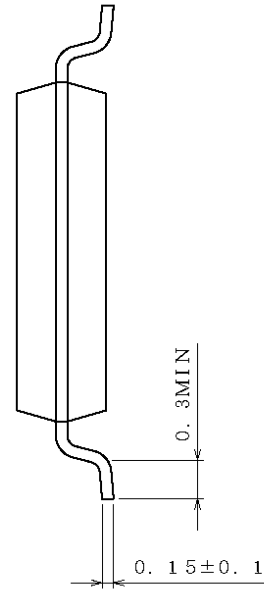
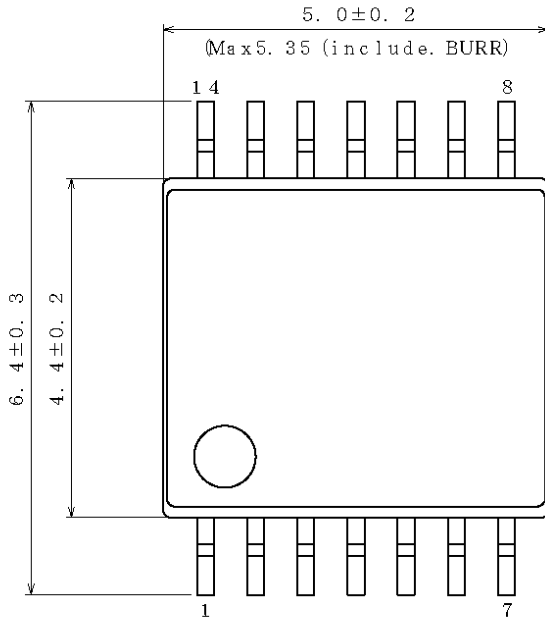

(UNIT : mm)  
 PKG : SSOP-B14  
 Drawing No. EX152-5002

<Tape and Reel information>

|                   |   |
|-------------------|---|
| Tape              | Embossed carrier tape   |
| Quantity          | 2500pcs   |
| Direction of feed | E2<br>( The direction is the 1pin of product is at the upper left when you hold reel on the left hand and you pull out the tape on the right hand ) |

Reel      1pin      Direction of feed

\*Order quantity needs to be multiple of the minimum quantity.

●Physical Dimension, Tape and Reel Information

|              |       |
|--------------|-------|
| Package Name | MSOP8 |
|--------------|-------|

(UNIT : mm)  
 PKG : MSOP8  
 Drawing No. EX181-5002

<Tape and Reel information>

|                   |  |
|-------------------|--|
| Tape              | Embossed carrier tape  |
| Quantity          | 3000pcs  |
| Direction of feed | TR<br>(The direction is the 1pin of product is at the upper right when you hold reel on the left hand and you pull out the tape on the right hand) |

Reel ←      → Direction of feed

\* Order quantity needs to be multiple of the minimum quantity.

● Marking Diagrams

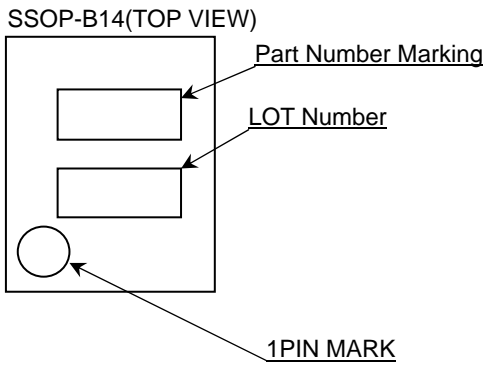
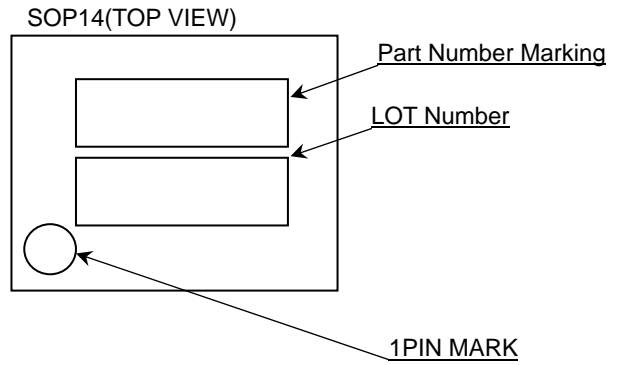
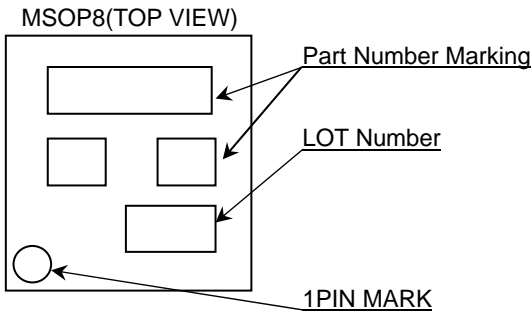
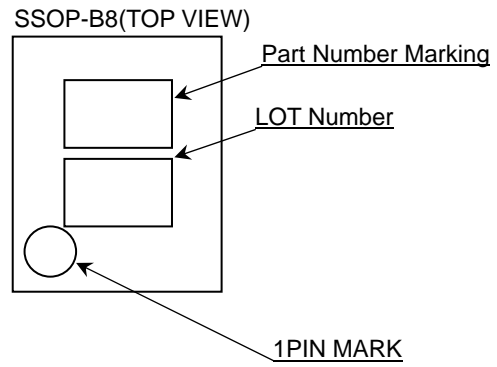
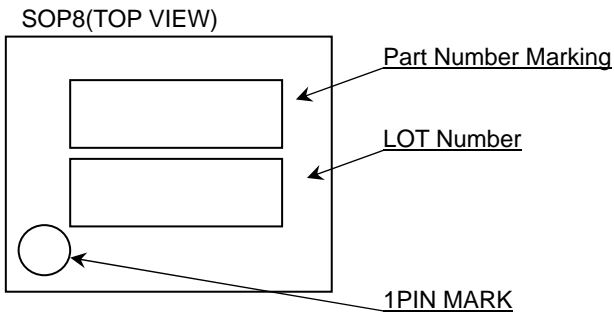

| Product Name |       | Package Type | Marking  |
|--------------|-------|--------------|----------|
| BA2904Y      | F-C   | SOP8         | 2904Y    |
|              | FV-C  | SSOP-B8      | 04Y      |
|              | FVM-C | MSOP8        | 2904Y    |
| BA2902Y      | F-C   | SOP14        | BA2902YF |
|              | FV-C  | SSOP-B14     | 2902Y    |

●Land pattern data

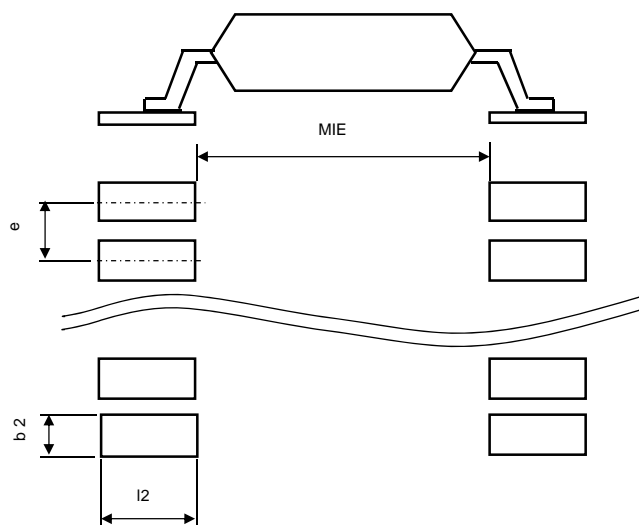

SOP8, SSOP-B8, MSOP8  
SOP14, SSOP-B14

All dimensions in mm

| Package             | Land pitch<br>e | Land space<br>MIE | Land length<br>≥ l 2 | Land width<br>b2 |
|---------------------|-----------------|-------------------|----------------------|------------------|
| SOP8<br>SOP14       | 1.27            | 4.60              | 1.10                 | 0.76             |
| SSOP-B8<br>SSOP-B14 | 0.65            | 4.60              | 1.20                 | 0.35             |
| MSOP8               | 0.65            | 2.62              | 0.99                 | 0.35             |

●Revision History

| Date        | Revision | Changes  |
|-------------|----------|--|
| 5.MAR.2012  | 001      | New Release  |
| 21.JAN.2013 | 002      | Land pattern data inserted.  |
| 11.MAR.2013 | 003      | Input offset voltage, Input offset current limit (Temp=25°C) changed.<br>Description of Physical Dimension, Tape and Reel Information changed. |
| 8.MAY.2013  | 004      | SOP8, SSOP-B8, MSOP8 Power dissipation corrected.<br>SSOP-B8 Description of Physical Dimension corrected.                                      |

# Notice

## Precaution on using ROHM Products

1. If you intend to use our Products in devices requiring extremely high reliability (such as medical equipment <sup>(Note 1)</sup>, aircraft/spacecraft, nuclear power controllers, etc.) and whose malfunction or failure may cause loss of human life, bodily injury or serious damage to property ("Specific Applications"), please consult with the ROHM sales representative in advance. Unless otherwise agreed in writing by ROHM in advance, ROHM shall not be in any way responsible or liable for any damages, expenses or losses incurred by you or third parties arising from the use of any ROHM's Products for Specific Applications.

(Note1) Medical Equipment Classification of the Specific Applications

| JAPAN     | USA       | EU         | CHINA     |
|-----------|-----------|------------|-----------|
| CLASS III | CLASS III | CLASS II b | CLASS III |
| CLASS IV  |           | CLASS III  |           |

2. ROHM designs and manufactures its Products subject to strict quality control system. However, semiconductor products can fail or malfunction at a certain rate. Please be sure to implement, at your own responsibilities, adequate safety measures including but not limited to fail-safe design against the physical injury, damage to any property, which a failure or malfunction of our Products may cause. The following are examples of safety measures:
  - [a] Installation of protection circuits or other protective devices to improve system safety
  - [b] Installation of redundant circuits to reduce the impact of single or multiple circuit failure
3. Our Products are not designed under any special or extraordinary environments or conditions, as exemplified below. Accordingly, ROHM shall not be in any way responsible or liable for any damages, expenses or losses arising from the use of any ROHM's Products under any special or extraordinary environments or conditions. If you intend to use our Products under any special or extraordinary environments or conditions (as exemplified below), your independent verification and confirmation of product performance, reliability, etc, prior to use, must be necessary:
  - [a] Use of our Products in any types of liquid, including water, oils, chemicals, and organic solvents
  - [b] Use of our Products outdoors or in places where the Products are exposed to direct sunlight or dust
  - [c] Use of our Products in places where the Products are exposed to sea wind or corrosive gases, including Cl<sub>2</sub>, H<sub>2</sub>S, NH<sub>3</sub>, SO<sub>2</sub>, and NO<sub>2</sub>
  - [d] Use of our Products in places where the Products are exposed to static electricity or electromagnetic waves
  - [e] Use of our Products in proximity to heat-producing components, plastic cords, or other flammable items
  - [f] Sealing or coating our Products with resin or other coating materials
  - [g] Use of our Products without cleaning residue of flux (even if you use no-clean type fluxes, cleaning residue of flux is recommended); or Washing our Products by using water or water-soluble cleaning agents for cleaning residue after soldering
  - [h] Use of the Products in places subject to dew condensation
4. The Products are not subject to radiation-proof design.
5. Please verify and confirm characteristics of the final or mounted products in using the Products.
6. In particular, if a transient load (a large amount of load applied in a short period of time, such as pulse. is applied, confirmation of performance characteristics after on-board mounting is strongly recommended. Avoid applying power exceeding normal rated power; exceeding the power rating under steady-state loading condition may negatively affect product performance and reliability.
7. De-rate Power Dissipation (Pd) depending on Ambient temperature (Ta). When used in sealed area, confirm the actual ambient temperature.
8. Confirm that operation temperature is within the specified range described in the product specification.
9. ROHM shall not be in any way responsible or liable for failure induced under deviant condition from what is defined in this document.

## Precaution for Mounting / Circuit board design

1. When a highly active halogenous (chlorine, bromine, etc.) flux is used, the residue of flux may negatively affect product performance and reliability.
2. In principle, the reflow soldering method must be used; if flow soldering method is preferred, please consult with the ROHM representative in advance.

For details, please refer to ROHM Mounting specification

**Precautions Regarding Application Examples and External Circuits**

1. If change is made to the constant of an external circuit, please allow a sufficient margin considering variations of the characteristics of the Products and external components, including transient characteristics, as well as static characteristics.
2. You agree that application notes, reference designs, and associated data and information contained in this document are presented only as guidance for Products use. Therefore, in case you use such information, you are solely responsible for it and you must exercise your own independent verification and judgment in the use of such information contained in this document. ROHM shall not be in any way responsible or liable for any damages, expenses or losses incurred by you or third parties arising from the use of such information.

**Precaution for Electrostatic**

This Product is electrostatic sensitive product, which may be damaged due to electrostatic discharge. Please take proper caution in your manufacturing process and storage so that voltage exceeding the Products maximum rating will not be applied to Products. Please take special care under dry condition (e.g. Grounding of human body / equipment / solder iron, isolation from charged objects, setting of ionizer, friction prevention and temperature / humidity control).

**Precaution for Storage / Transportation**

1. Product performance and soldered connections may deteriorate if the Products are stored in the places where:
  - [a] the Products are exposed to sea winds or corrosive gases, including Cl<sub>2</sub>, H<sub>2</sub>S, NH<sub>3</sub>, SO<sub>2</sub>, and NO<sub>2</sub>
  - [b] the temperature or humidity exceeds those recommended by ROHM
  - [c] the Products are exposed to direct sunshine or condensation
  - [d] the Products are exposed to high Electrostatic
2. Even under ROHM recommended storage condition, solderability of products out of recommended storage time period may be degraded. It is strongly recommended to confirm solderability before using Products of which storage time is exceeding the recommended storage time period.
3. Store / transport cartons in the correct direction, which is indicated on a carton with a symbol. Otherwise bent leads may occur due to excessive stress applied when dropping of a carton.
4. Use Products within the specified time after opening a humidity barrier bag. Baking is required before using Products of which storage time is exceeding the recommended storage time period.

**Precaution for Product Label**

QR code printed on ROHM Products label is for ROHM's internal use only.

**Precaution for Disposition**

When disposing Products please dispose them properly using an authorized industry waste company.

**Precaution for Foreign Exchange and Foreign Trade act**

Since our Products might fall under controlled goods prescribed by the applicable foreign exchange and foreign trade act, please consult with ROHM representative in case of export.

**Precaution Regarding Intellectual Property Rights**

1. All information and data including but not limited to application example contained in this document is for reference only. ROHM does not warrant that foregoing information or data will not infringe any intellectual property rights or any other rights of any third party regarding such information or data. ROHM shall not be in any way responsible or liable for infringement of any intellectual property rights or other damages arising from use of such information or data.:
2. No license, expressly or implied, is granted hereby under any intellectual property rights or other rights of ROHM or any third parties with respect to the information contained in this document.

**Other Precaution**



1. This document may not be reprinted or reproduced, in whole or in part, without prior written consent of ROHM.
2. The Products may not be disassembled, converted, modified, reproduced or otherwise changed without prior written consent of ROHM.
3. In no event shall you use in any way whatsoever the Products and the related technical information contained in the Products or this document for any military purposes, including but not limited to, the development of mass-destruction weapons.
4. The proper names of companies or products described in this document are trademarks or registered trademarks of ROHM, its affiliated companies or third parties.

**General Precaution**





1. Before you use our Products, you are requested to carefully read this document and fully understand its contents. ROHM shall not be in any way responsible or liable for failure, malfunction or accident arising from the use of any ROHM's Products against warning, caution or note contained in this document.
2. All information contained in this document is current as of the issuing date and subject to change without any prior notice. Before purchasing or using ROHM's Products, please confirm the latest information with a ROHM sales representative.
3. The information contained in this document is provided on an "as is" basis and ROHM does not warrant that all information contained in this document is accurate and/or error-free. ROHM shall not be in any way responsible or liable for any damages, expenses or losses incurred by you or third parties resulting from inaccuracy or errors of or concerning such information.

## Looking for pricing, stock, or lifecycle information?

Click below to explore more details on WIN SOURCE:

-  [View BA2904YF-CE2 on WIN SOURCE](#)
-  [Rohm Semiconductor](#) Information

## Optimize Your Supply Chain with WIN SOURCE Solutions

-  Global Sourcing Solution
-  Obsolete Management
-  Cost Control Management
-  Shortage Management
-  Alternative Solution
-  Excess Inventory Management