



# THE DATASHEET OF BD00C0AWHFP-CTR



# Single-Output LDO Regulators

## 35V Voltage Resistance

## 1A LDO Regulators

**BDxxC0A-C series    BDxxC0AW-C series**

### General Description

The BDxxC0A-C series and the BDxxC0AW-C series are low-saturation regulators. This series feature variable and fixed voltage output with selectable Shutdown switch (referred to as SW); Vout-3.3V, 5.0V, 8.0V and 9.0V. Five conventional PKGs; TO252-3/5, HRP5 and TO263-3(F)/5 are available. This series has a built-in over-current protection circuit that prevents the destruction of the IC due to output short circuits and a thermal Shutdown circuit that protects the IC from thermal damage due to overloading.

### Features

- 1) Output current capability: 1A
- 2) Output voltage: Variable, 3.3V, 5.0V, 8.0V and 9.0V
- 3) High output voltage accuracy  
(Ta=25°C, TO252-3/5, HRP5): ±1%
- 4) Low saturation with PDMOS output
- 5) Built-in over-current protection circuit that prevents the destruction of the IC due to output short circuits
- 6) Built-in thermal Shutdown circuit for protecting the IC from thermal damage due to overloading
- 7) Low ESR Capacitor
- 8) TO252-3/5, HRP5, TO263-3(F)/5 package
- 9) AEC-Q100 Qualified (Note 1)  
(Note 1: Grade 1)

### Key Specifications

- Supply Voltage(Vo ≥ 3.0V):                   Vo+1.0V to 26.5V
- Supply Voltage(Vo < 3.0V):                4.0V to 26.5V
- Output Voltage(BD00C0AW):               1.0V to 15.0V
- Output Current:                                1A
- Output Voltage Precision  
(Ta=25°C): ±1% (TO252-3/5, HRP5)  
(-40°C ≤ Ta ≤ +125°C):                   ±3%
- Operating Temperature Range:           -40°C ≤ Ta ≤ +125°C

### Applications

Automotive  
(body, audio system, navigation system, etc.)

### Ordering part number

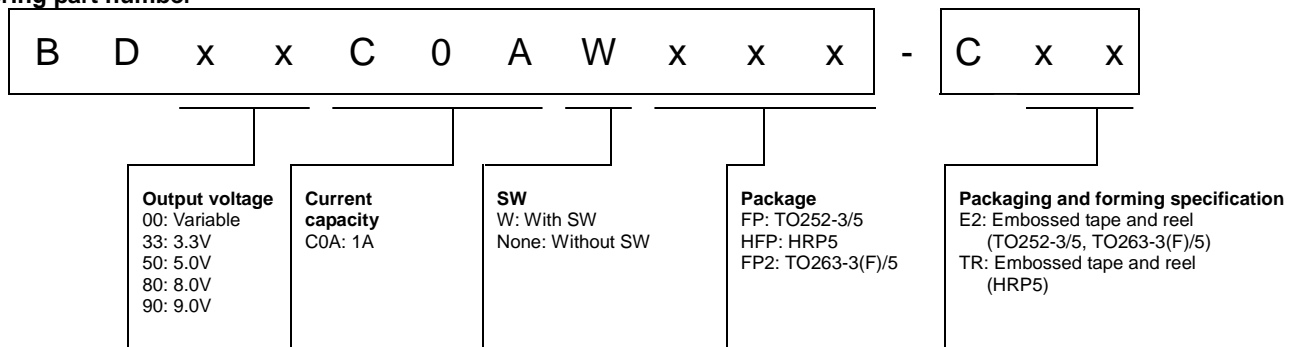

Lineup

Articles	Variable	3.3	5.0	8.0	9.0	Package	
BDxxC0AWFP-CE2	○	○	○	○	○	TO252-5	Reel of 2000
BDxxC0AFP-CE2	-	○	○	○	○	TO252-3	Reel of 2000
BDxxC0AWHFP-CTR	○	○	○	○	○	HRP5	Reel of 2000
BDxxC0AHFP-CTR	-	○	○	○	○	HRP5	Reel of 2000
BDxxC0AWFP2-CE2	○	○	○	○	○	TO263-5	Reel of 500
BDxxC0AFP2-CE2	-	○	○	○	○	TO263-3(F)	Reel of 500

Typical Application Circuits

〈Output Voltage Variable Type (With SW)〉

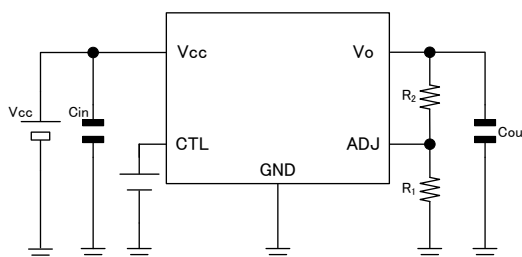

Figure 1. Typical Application Circuit Output Voltage Variable Type (With SW)

〈Output Voltage Fixation Type (With SW)〉

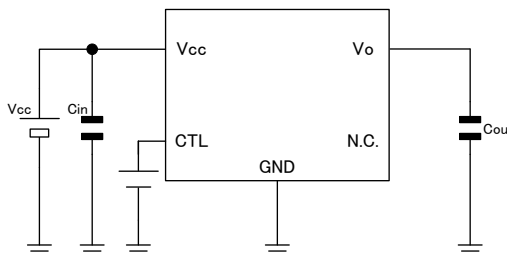

Figure 2. Typical Application Circuit Output Voltage Fixation Type (With SW)

〈Output Voltage Fixation Type (Without SW)〉

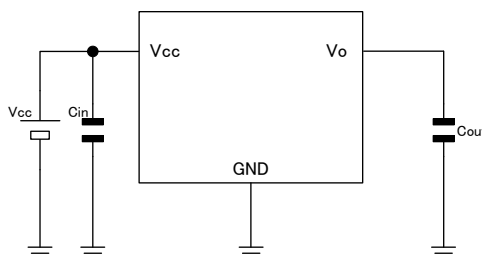

Figure 3. Typical Application Circuit Output Voltage Fixation Type (Without SW)

Pin Configurations/Pin Descriptions

⟨With SW (TO252-5/HRP5/TO263-5)⟩

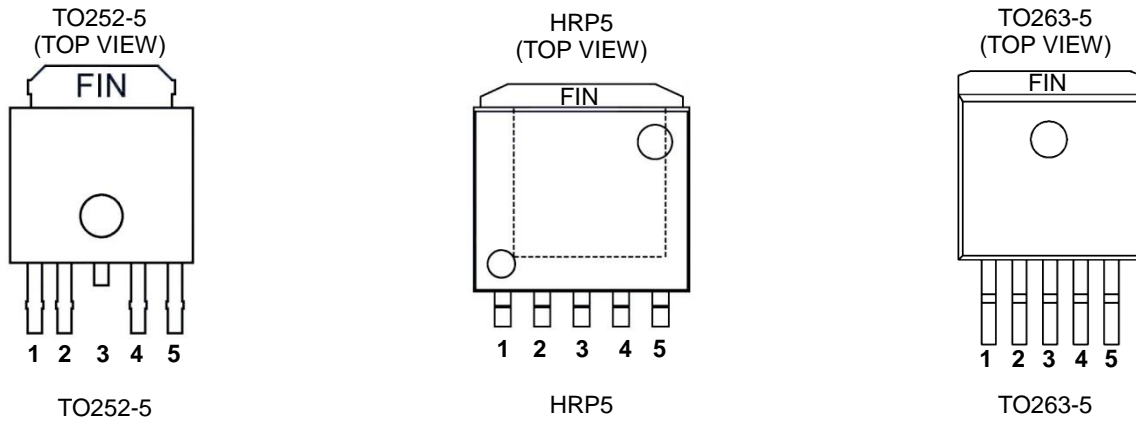

Figure 4. Pin Configurations (With SW)

Pin No.	Pin Name	Function
1	CTL	Output Control Pin
2	Vcc	Power Supply Pin
3	N.C. (Note 1) GND	N.C. Pin (TO252-5) GND (HRP5/TO263-5)
4	Vo	Output Pin
5	ADJ N.C. (Note 1)	Variable Pin (BD00C0AW) N.C. Pin (BD33/50/80/90C0AW)
FIN	GND	GND

(Note 1) N.C.Pin can be open. Because it isn't connect it inside of IC.

⟨Without SW (TO252-3/TO263-3(F))⟩

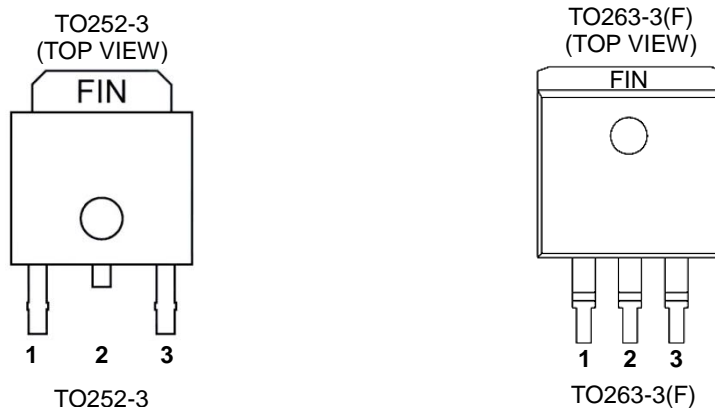

Figure 5. Pin Descriptions (Without SW)

Pin No.	Pin Name	Function
1	Vcc	Power Supply Pin
2	N.C. (Note 1) GND	N.C. Pin (TO252-3) GND (TO263-3(F))
3	Vo	Output Pin
FIN	GND	GND

(Note 1) N.C.Pin can be open. Because it isn't connect it inside of IC.

〈Without SW (HRP5)〉

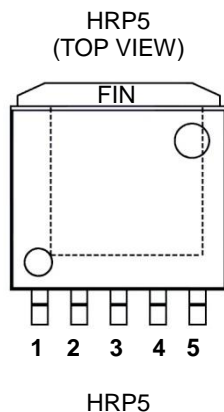

Figure 6. Pin Descriptions (Without SW) (HRP5)

Pin No.	Pin Name	Function
1	Vcc	Power Supply Pin
2	N.C. (Note 1)	N.C. Pin
3	GND	GND
4	N.C.	N.C. Pin
5	Vo	Output Pin
FIN	GND	GND

(Note 1) N.C.Pin can be open. Because it isn't connect it inside of IC.

Block Diagrams

<BD00C0AWFP/WHFP/WFP2-C (Output Voltage Variable Type, With SW) >

■ TO252-5/HRP5/TO263-5

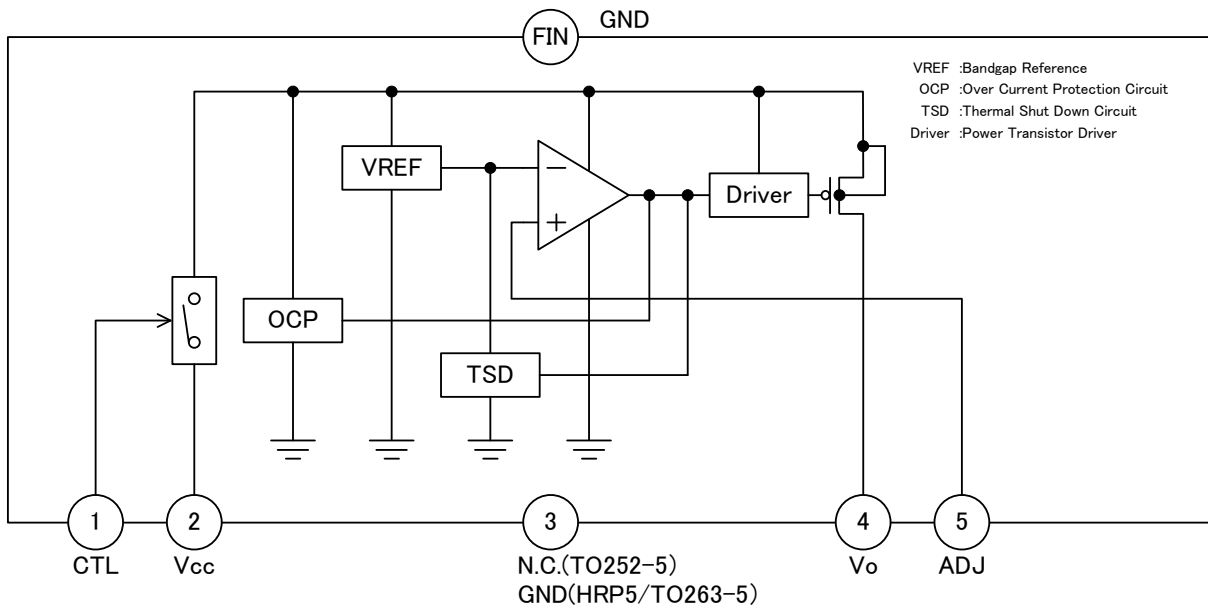

Figure 7. Block diagram  
 BD00C0AWFP/WHFP/WFP2-C (Output Voltage Variable Type, With SW)

<BDxxC0AWFP/WHFP/WFP2-C (Output Voltage Fixation Type, With SW) >

■ TO252-5/HRP5/TO263-5

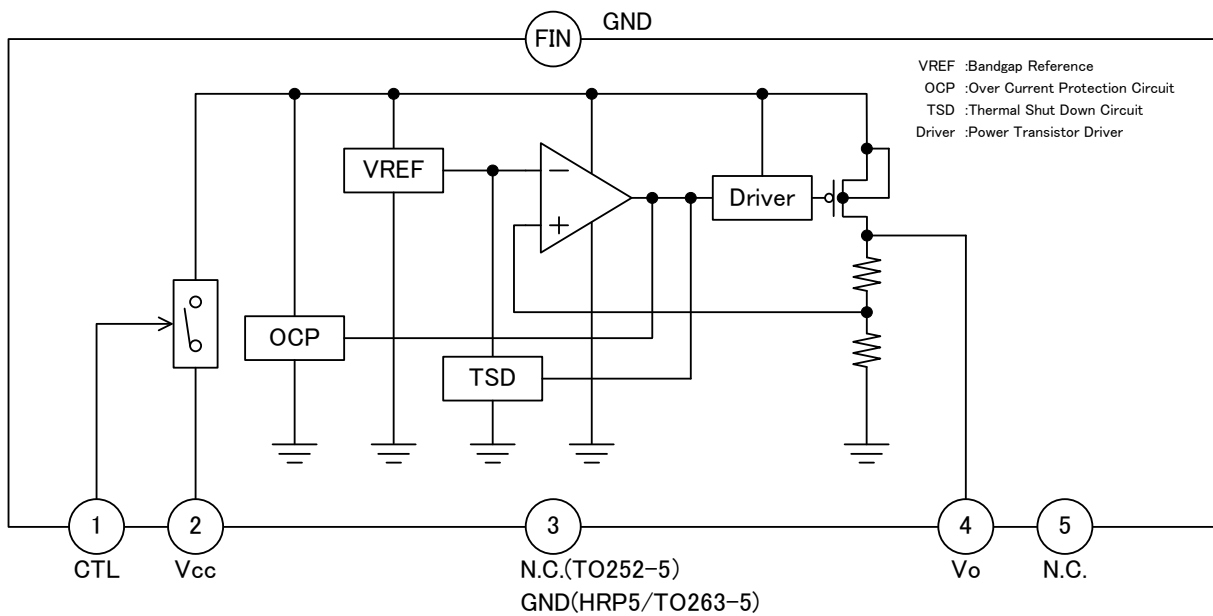

Figure 8. Block diagram  
 BDxxC0AWFP/WHFP/WFP2-C (Output Voltage Fixation Type, With SW)

<BDxxC0AFP/HFP/FP2-C (Output Voltage Fixation Type, Without SW) >

■TO252-3/TO263-3(F)

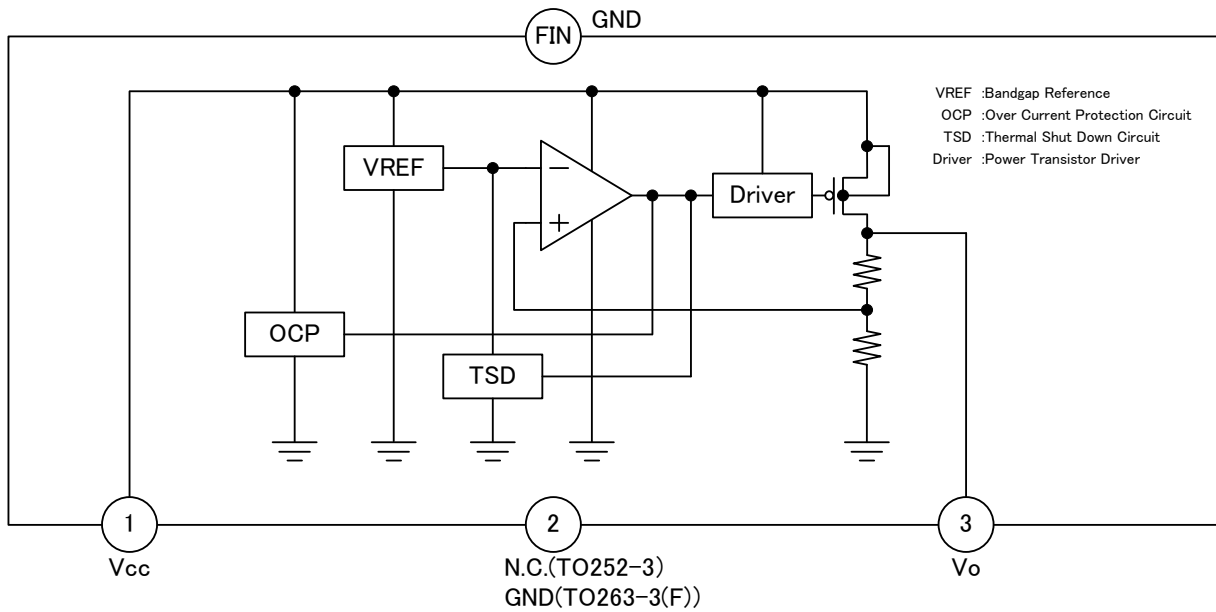

Figure 9. Block diagram  
 BDxxC0AFP/FP2-C (Output Voltage Fixation Type, Without SW)

■HRP5

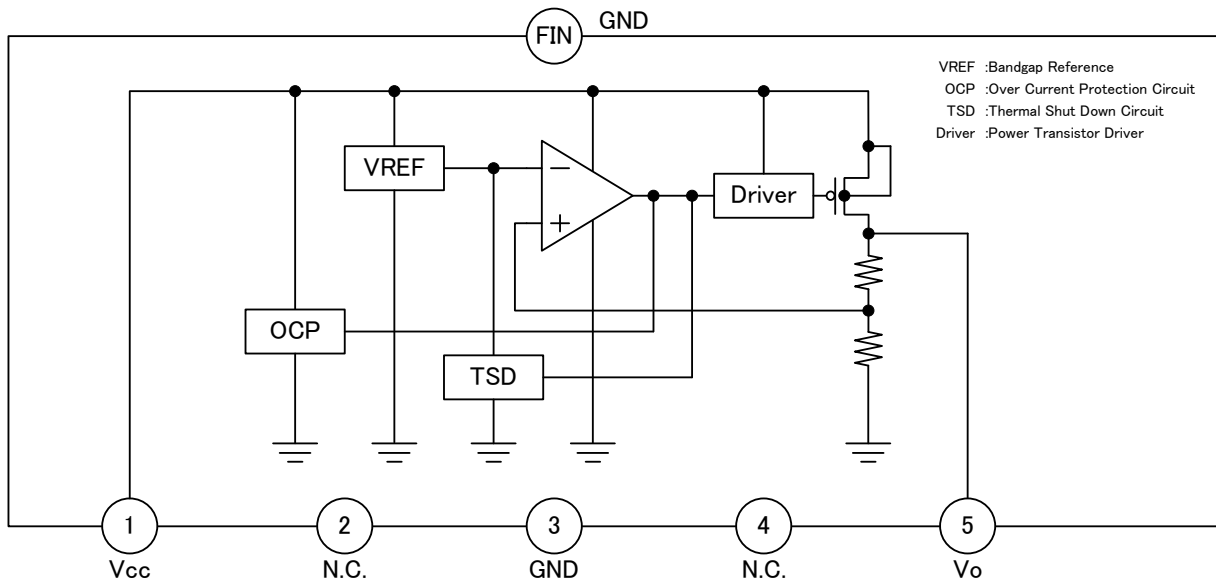

Figure 10. Block diagram  
 BDxxC0AHFP-C (Output Voltage Fixation Type, Without SW)

## Absolute Maximum Ratings (Ta= 25°C)

Parameter	Symbol	Ratings	Unit
Supply Voltage (Note 1)	Vcc	-0.3 to +35.0	V
Output Control Voltage (With SW) (Note 2)	V <sub>CTL</sub>	-0.3 to +35.0	V
Operating Temperature Range	T <sub>opr</sub>	-40 to +125	°C
Storage Temperature Range	T <sub>stg</sub>	-55 to +150	°C
Maximum Junction Temperature	T <sub>jmax</sub>	150	°C

(Note 1) Do not exceed Pd (Please refer to Power Dissipation in P.27-29).

(Note 2) The order of starting up power supply (Vcc) and CTL pin doesn't have either in the problem within the range of the operation power-supply voltage ahead.

**Caution:** Operating the IC over the absolute maximum ratings may damage the IC. The damage can either be a short circuit between pins or an open circuit between pins and the internal circuitry. Therefore, it is important to consider circuit protection measures, such as adding a fuse, in case the IC is operated over the absolute maximum ratings.

## Recommended Operating Conditions (-40°C ≤ Ta ≤ +125°C)

Parameter	Symbol	Min	Max.	Unit
Supply Voltage (Vo ≥ 3.0V)	Vcc	Vo+1	26.5	V
Supply Voltage (Vo < 3.0V)	Vcc	4.0	26.5	V
Startup Voltage (Io=0mA)	Vcc	-	3.8	V
Output Control Voltage (With SW)	V <sub>CTL</sub>	0	26.5	V
Output Current	I <sub>o</sub>	0	1.0	A
Output Voltage (BD00C0AW) (Note 1)	Vo	1.0	15.0	V

(Note 1) Please refer to Notes15 for use when you use BD00C0AW by output voltage  $1.0V \leq V_o < 3.0V$ .

## Thermal Resistance (Note 1)

Parameter	Symbol	Thermal Resistance (Typ)		Unit
		1s <sup>(Note 3)</sup>	2s2p <sup>(Note 4)</sup>	
TO252-3, TO252-5				
Junction to Ambient	$\theta_{JA}$	136	23	°C/W
Junction to Top Characterization Parameter <sup>(Note 2)</sup>	$\Psi_{JT}$	17	3	°C/W
HRP5				
Junction to Ambient	$\theta_{JA}$	120	22	°C/W
Junction to Top Characterization Parameter <sup>(Note 2)</sup>	$\Psi_{JT}$	8	3	°C/W
TO263-3(F), TO263-5				
Junction to Ambient	$\theta_{JA}$	81	21	°C/W
Junction to Top Characterization Parameter <sup>(Note 2)</sup>	$\Psi_{JT}$	8	2	°C/W

(Note 1)Based on JESD51-2A (Still-Air)

(Note 2)The thermal characterization parameter to report the difference between junction temperature and the temperature at the top center of the outside surface of the component package.

(Note 3)Using a PCB board based on JESD51-3.

Layer Number of Measurement Board	Material	Board Size
Single	FR-4	114.3mm x 76.2mm x 1.57mm

Top	
Copper Pattern	Thickness
Footprints and Traces	70μm

(Note 4)Using a PCB board based on JESD51-5, 7.

Layer Number of Measurement Board	Material	Board Size	Thermal Via <sup>(Note 5)</sup>	
			Pitch	Diameter
4 Layers	FR-4	114.3mm x 76.2mm x 1.6mm	1.20mm	Φ0.30mm

Top		2 Internal Layers		Bottom	
Copper Pattern	Thickness	Copper Pattern	Thickness	Copper Pattern	Thickness
Footprints and Traces	70μm	74.2mm x 74.2mm	35μm	74.2mm x 74.2mm	70μm

(Note 5) This thermal via connects with the copper pattern of all layers. The placement and dimensions obey a land pattern.

## Electrical Characteristics

Unless otherwise specified,  $-40^{\circ}\text{C} \leq T_a \leq +125^{\circ}\text{C}$ ,  $V_{CC}=13.5\text{V}$ ,  $I_o=0\text{mA}$ ,  $V_{CTL}=5.0\text{V}$  (With SW)

The resistor of between ADJ and  $V_o = 56.7\text{k}\Omega$ , ADJ and GND =  $10\text{k}\Omega$  (BD00C0AW)

Parameter	Symbol	Guaranteed Limit			Unit	Conditions
		Min.	Typ.	Max.		
Shutdown Current (With SW)	I <sub>sd</sub>	-	0	5	μA	V <sub>CTL</sub> =0V
Circuit Current	I <sub>b</sub>	-	0.5	2.5	mA	
ADJ Terminal Voltage (BD00C0AWFP/WHFP)	V <sub>ADJ</sub>	0.742	0.750	0.758	V	I <sub>o</sub> =50mA, T <sub>a</sub> =25°C
ADJ Terminal Voltage (BD00C0AW)	V <sub>ADJ</sub>	0.727	0.750	0.773	V	I <sub>o</sub> =50mA
Output Voltage (BD33/50C0A(W9FP/(W)HFP)	V <sub>o</sub>	V <sub>o</sub> ×0.99	V <sub>o</sub>	V <sub>o</sub> ×1.01	V	I <sub>o</sub> =200mA, T <sub>a</sub> =25°C
Output Voltage (BD33/50C0A(W))	V <sub>o</sub>	V <sub>o</sub> ×0.97	V <sub>o</sub>	V <sub>o</sub> ×1.03	V	I <sub>o</sub> =200mA
Output Voltage (BD80/90C0A(W)FP/(W)HFP)	V <sub>o</sub>	V <sub>o</sub> ×0.99	V <sub>o</sub>	V <sub>o</sub> ×1.01	V	I <sub>o</sub> =500mA, T <sub>a</sub> =25°C
Output Voltage (BD80/90C0A(W))	V <sub>o</sub>	V <sub>o</sub> ×0.97	V <sub>o</sub>	V <sub>o</sub> ×1.03	V	I <sub>o</sub> =500mA
Dropout Voltage (BD00/50/80/90C0A(W))	ΔV <sub>d</sub>	-	0.3	0.5	V	V <sub>CC</sub> =V <sub>o</sub> ×0.95, I <sub>o</sub> =500mA
Ripple Rejection (BD00/33/50C0A(W))	R.R.	45	55	-	dB	f=120Hz, Input Voltage Ripple =1Vms, I <sub>o</sub> =100mA
Ripple Rejection (BD80/90C0A(W))	R.R.	40	50	-	dB	f=120Hz, Input Voltage Ripple =1Vms, I <sub>o</sub> =100mA
Line Regulation	Reg.I	-	20	80	mV	V <sub>o</sub> +1.0V ≤ V <sub>CC</sub> ≤ 26.5V
Load Regulation	Reg.L	-	$\frac{V_o}{\times 0.010}$	$\frac{V_o}{\times 0.020}$	V	5mA ≤ I <sub>o</sub> ≤ 1A
CTL ON Mode Voltage (With SW)	V <sub>thH</sub>	2.0	—	—	V	ACTIVE MODE
CTL OFF Mode Voltage (With SW)	V <sub>thL</sub>	—	—	0.8	V	OFF MODE
CTL Bias Current (With SW)	I <sub>CTL</sub>	—	25	50	μA	

Reference Data

■ BD00C0AW-C series (Vo=5.0V)

Unless otherwise specified,  $-40^{\circ}\text{C} \leq T_a \leq +125^{\circ}\text{C}$ ,  $V_{CC}=13.5\text{V}$ ,  $V_{CTL}=5.0\text{V}$ ,  $I_o=0\text{mA}$ ,  $V_o=5.0\text{V}$

(The resistor of between ADJ and Vo =56.7kΩ, ADJ and GND =10kΩ)

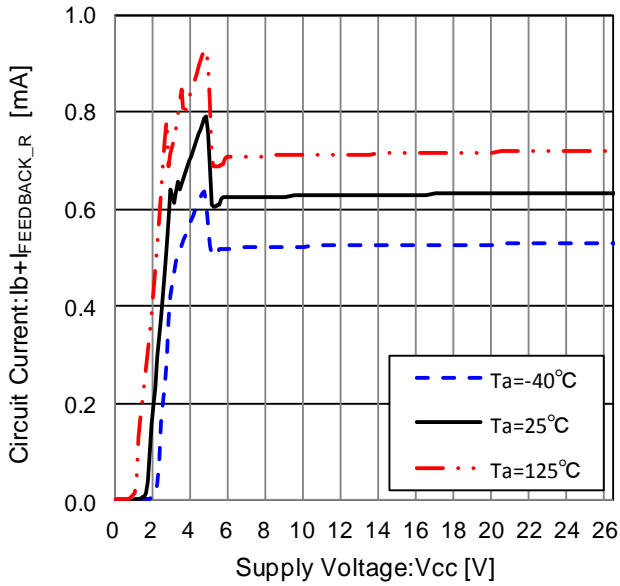

Figure 11. Circuit Current  
( $I_{FEEDBACK\_R}(\text{Note 1}) \approx 75\mu\text{A}$ )  
(Note 1)  $I_{FEEDBACK\_R}$  is the current flowing into external feedback resistance.

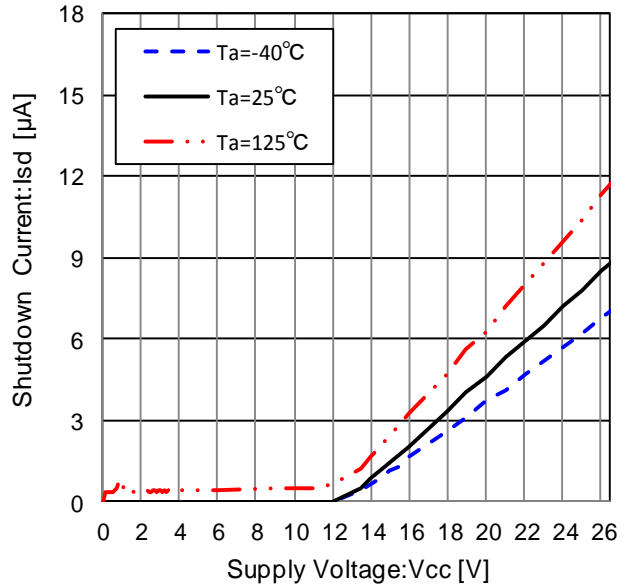

Figure 12. Shutdown Current  
( $V_{CTL}=0\text{V}$ )

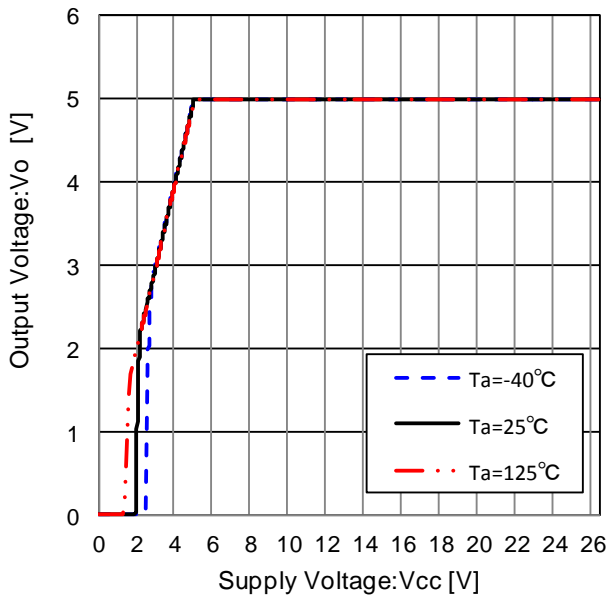

Figure 13. Line Regulation  
( $I_o=0\text{mA}$ )

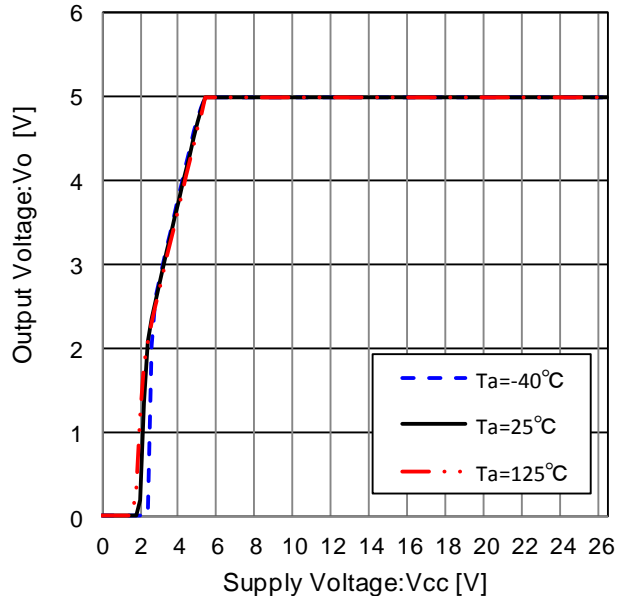

Figure 14. Line Regulation  
( $I_o=500\text{mA}$ )

Reference Data - continued

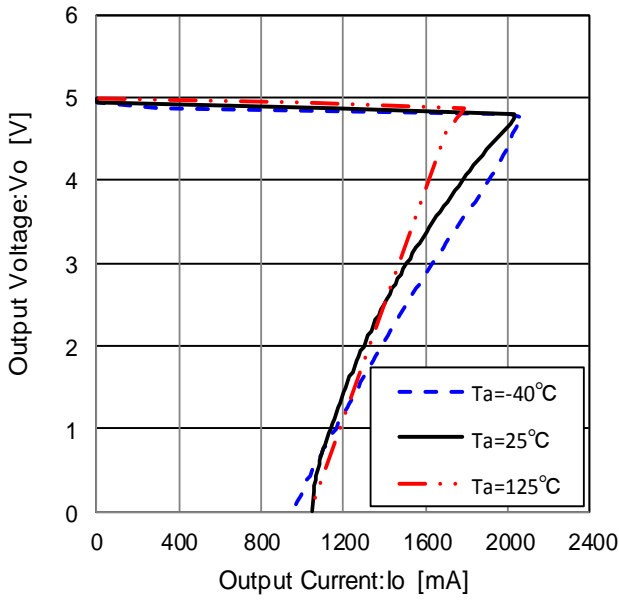

Figure 15. Load Regulation

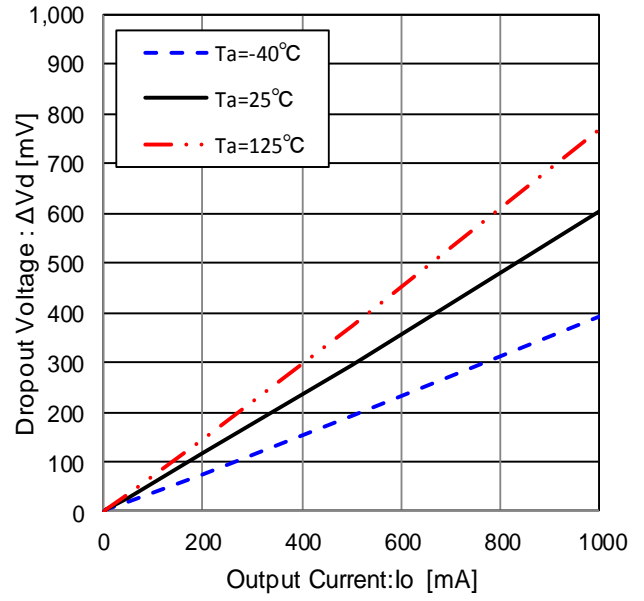

Figure 16. Dropout Voltage  
(Vcc=Vox0.95=4.75V)

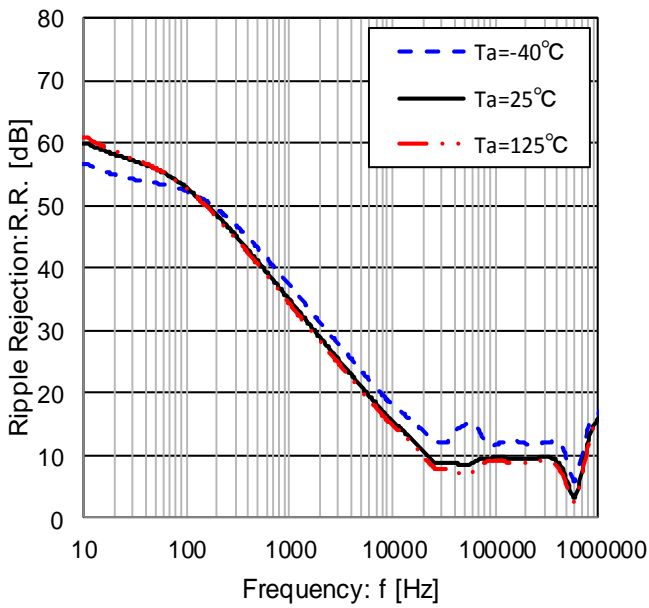

Figure 17. Ripple Rejection  
(Io=100mA)

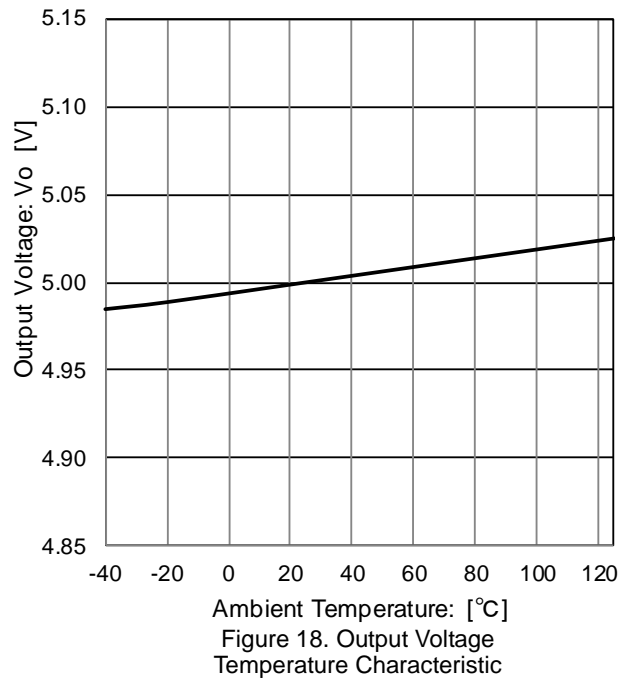

Figure 18. Output Voltage  
Temperature Characteristic

Reference Data - continued

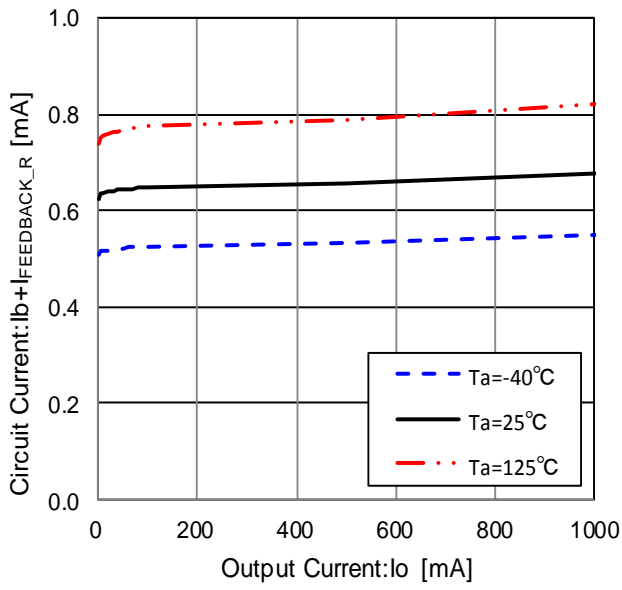

Figure 19. Circuit Current  
( $0\text{mA} \leq I_o \leq 1000\text{mA}$ ,  $I_{FEEDBACK\_R} \approx 75\mu\text{A}$ )

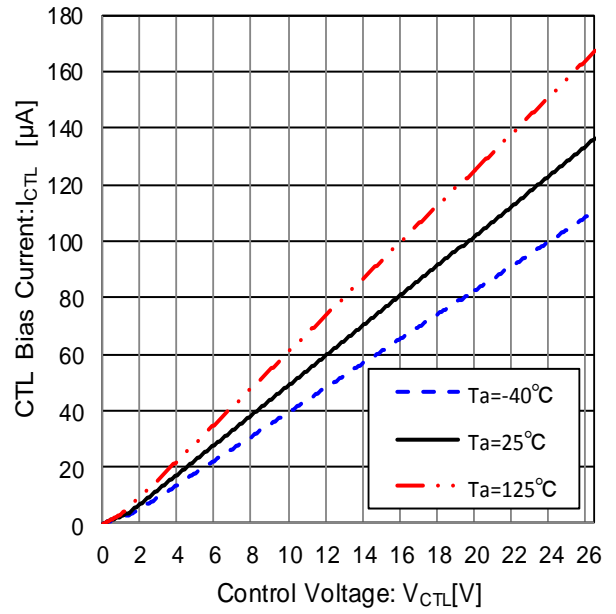

Figure 20. CTL Current vs CTL Voltage

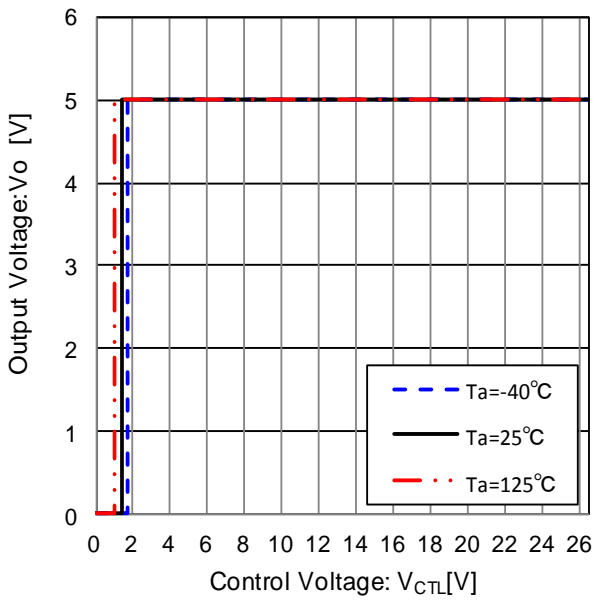

Figure 21. Output Voltage vs CTL Voltage

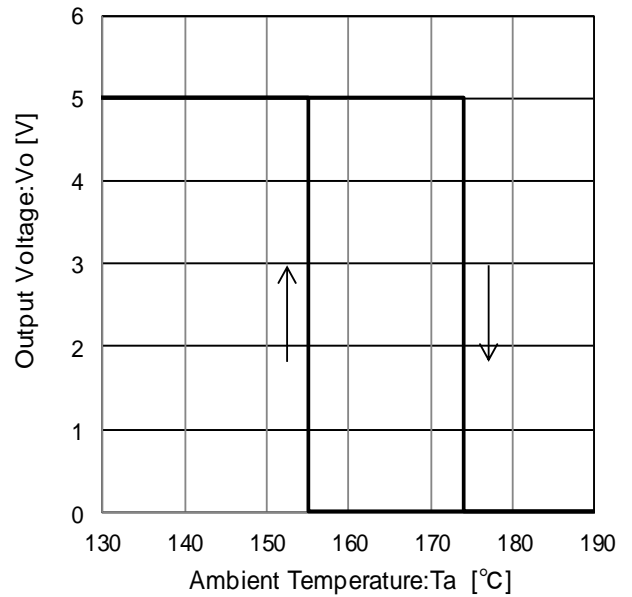
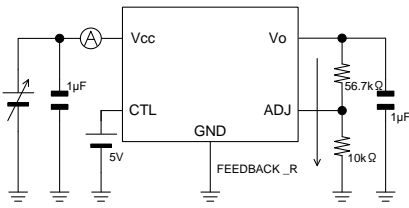

Figure 22. Thermal Shutdown  
Circuit Characteristic

Measurement setup for reference data

■ BD00C0AW-C series (Vo=5.0V)



Measurement setup for Figure 11

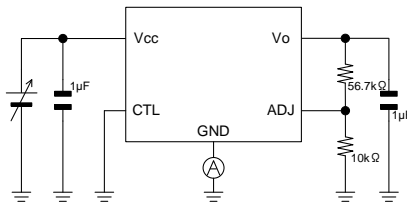

Measurement setup for Figure 12

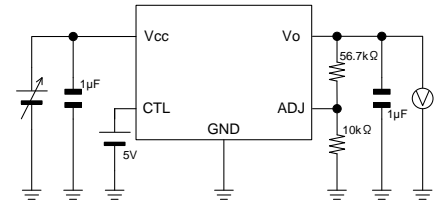

Measurement setup for Figure 13

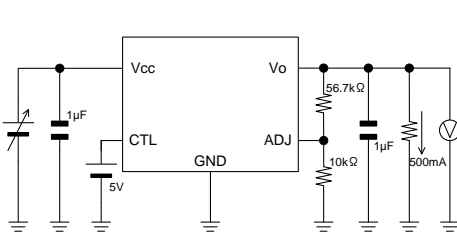

Measurement setup for Figure 14

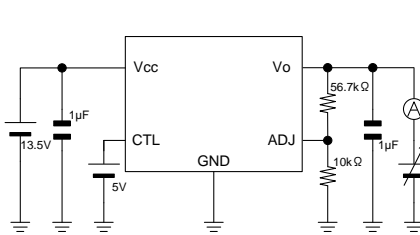

Measurement setup for Figure 15

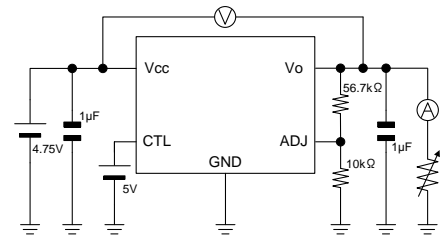

Measurement setup for Figure 16

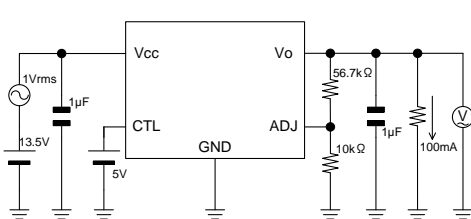

Measurement setup for Figure 17

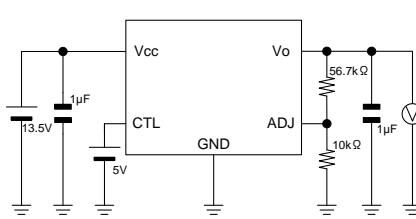

Measurement setup for Figure 18

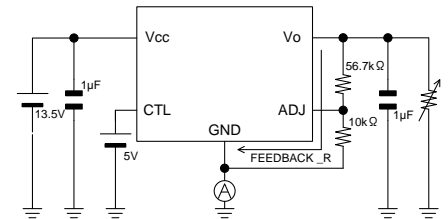

Measurement setup for Figure 19

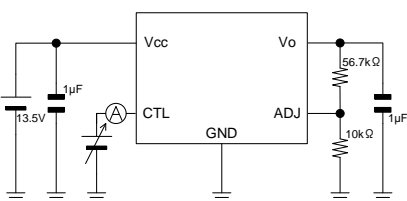

Measurement setup for Figure 20

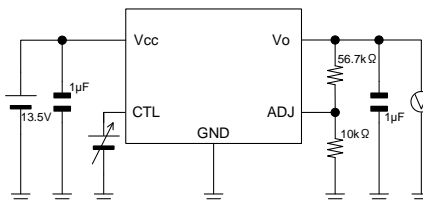

Measurement setup for Figure 21

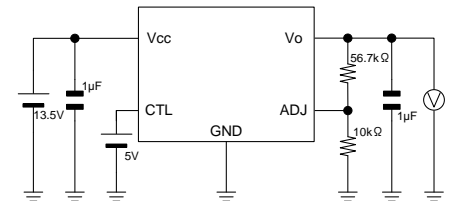

Measurement setup for Figure 22

Reference Data

■ BD33C0A-C/ BD33C0AW-C series

Unless otherwise specified,  $-40^{\circ}\text{C} \leq T_a \leq +125^{\circ}\text{C}$ ,  $V_{CC}=13.5\text{V}$ ,  $V_{CTL}=5.0\text{V}$  (With SW),  $I_o=0\text{mA}$

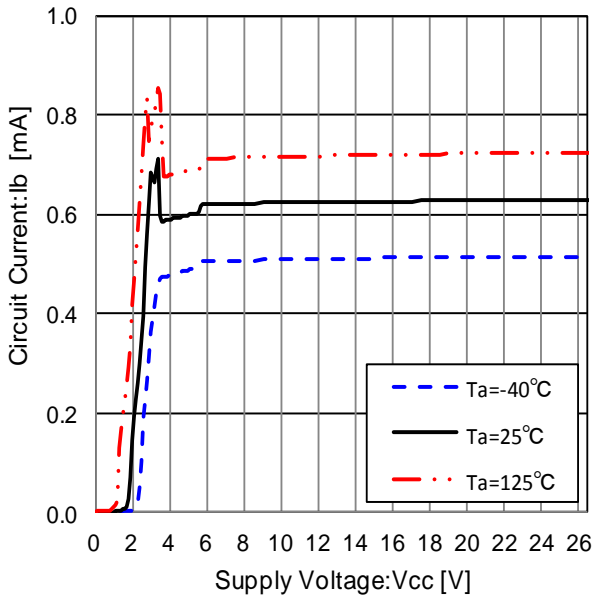

Figure 23. Circuit Current

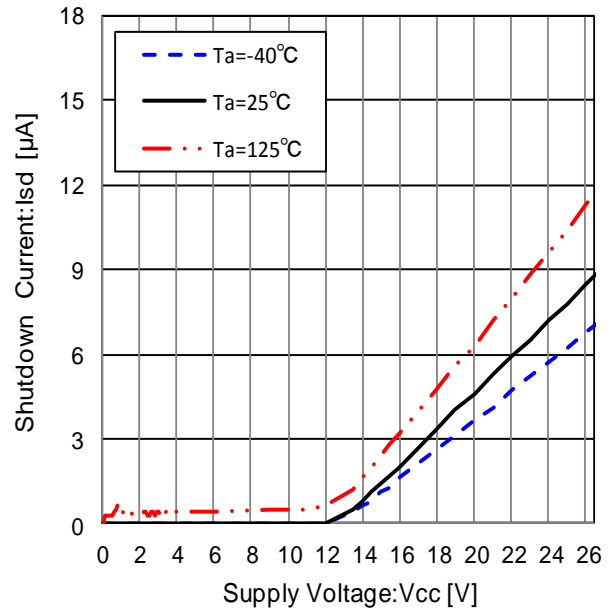

Figure 24. Shutdown Current ( $V_{CTL}=0\text{V}$ )

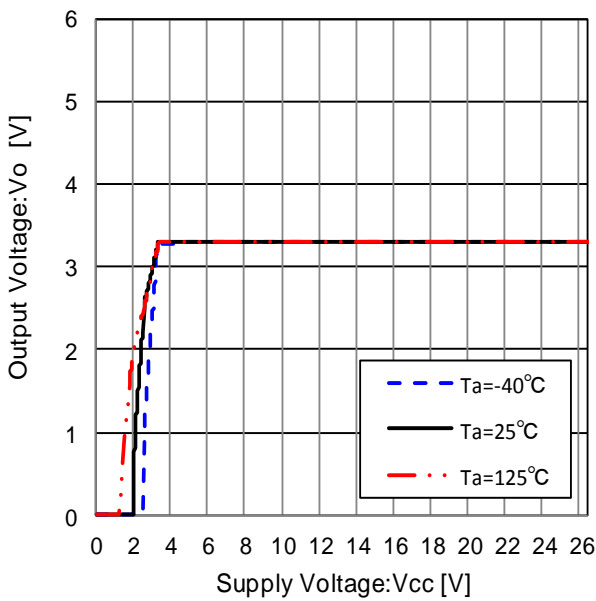

Figure 25. Line Regulation ( $I_o=0\text{mA}$ )

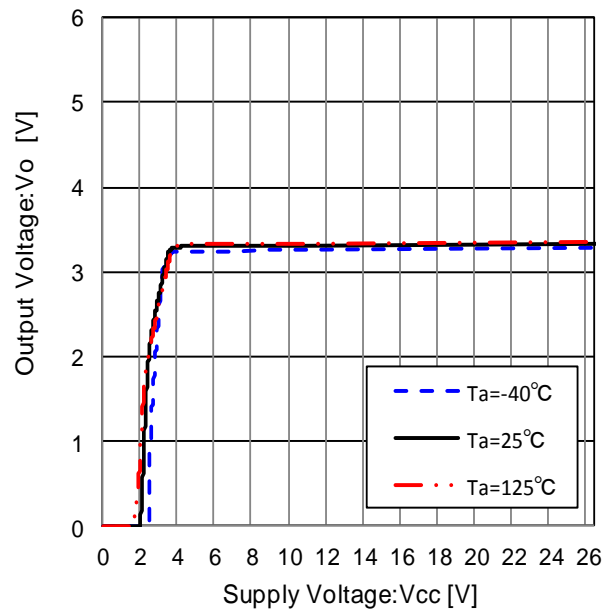

Figure 26. Line Regulation ( $I_o=500\text{mA}$ )

Reference Data - continued

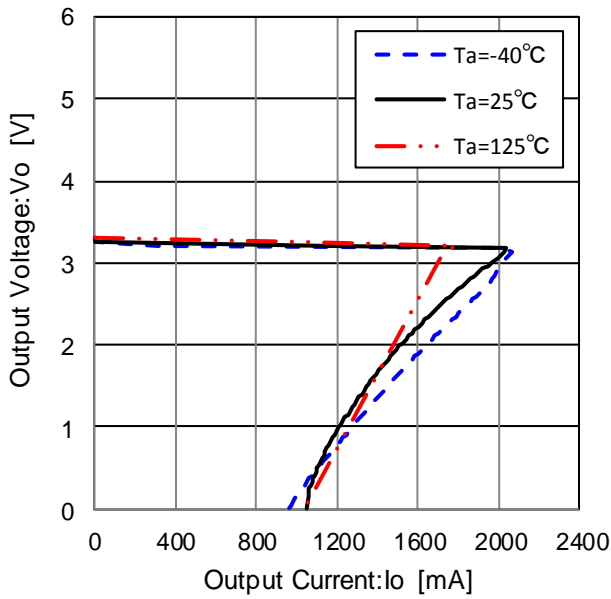

Figure 27. Load Regulation

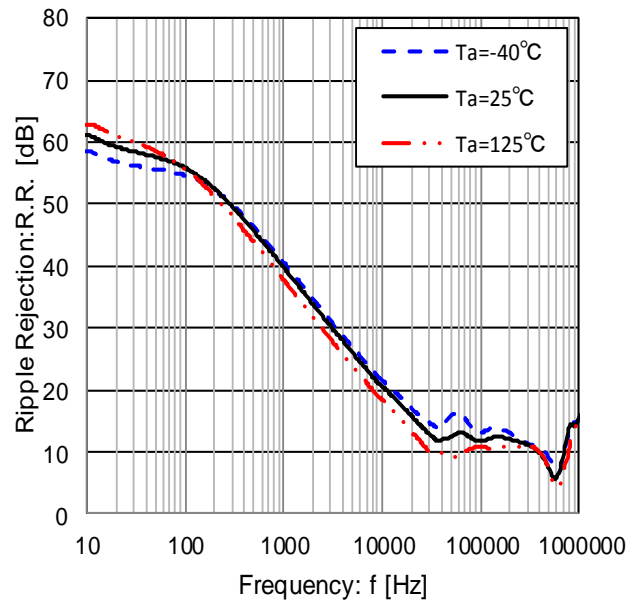

Figure 28. Ripple Rejection (I\_o=100mA)

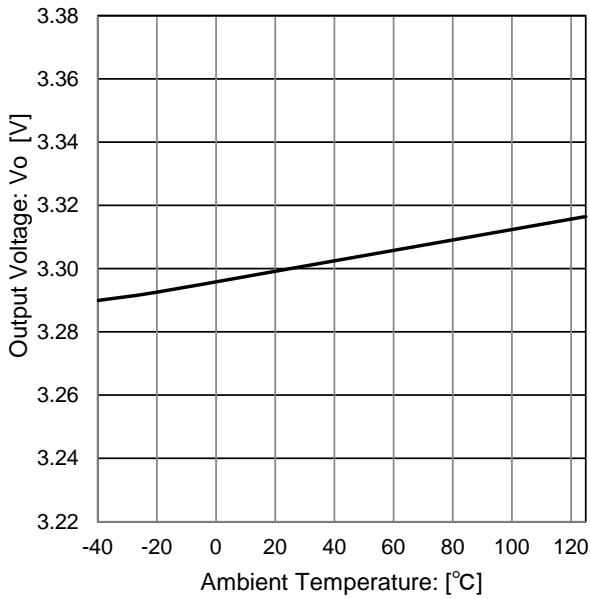

Figure 29. Output Voltage Temperature Characteristic

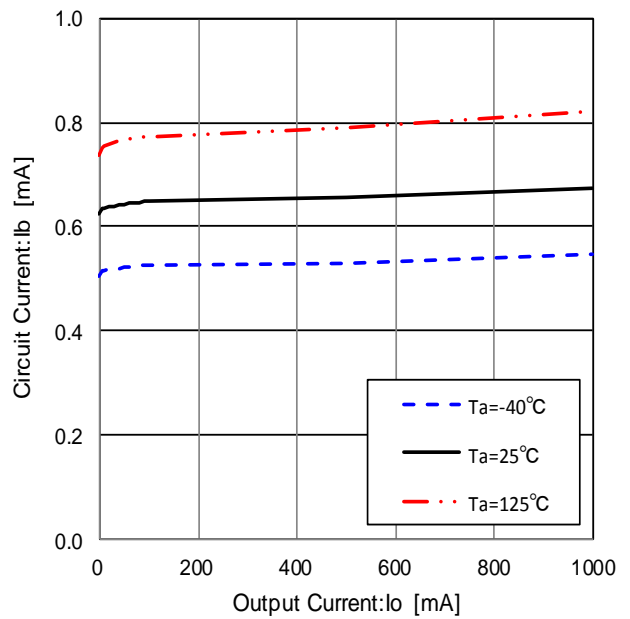

Figure 30. Circuit Current

Reference Data - continued

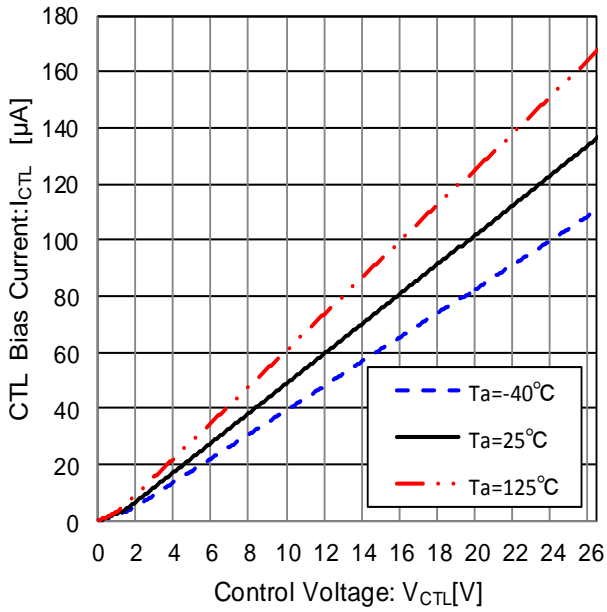

Figure 31. CTL Current vs CTL Voltage

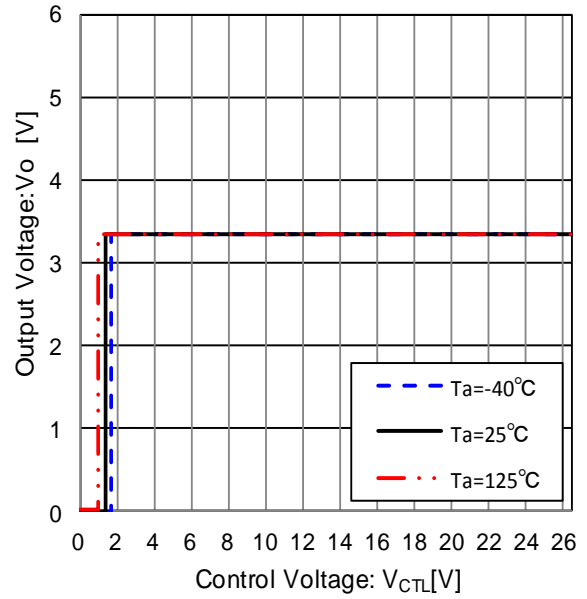

Figure 32. Output Voltage vs CTL Voltage

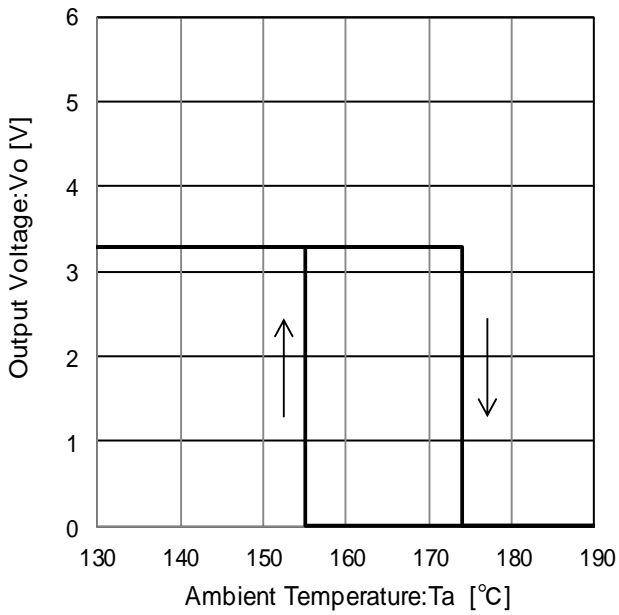

Figure 33. Thermal Shutdown Circuit Characteristic

Reference Data

■ BD50C0A-C/ BD50C0AW-C series

Unless otherwise specified,  $-40^{\circ}\text{C} \leq T_a \leq +125^{\circ}\text{C}$ ,  $V_{CC}=13.5\text{V}$ ,  $V_{CTL}=5.0\text{V}$  (With SW),  $I_o=0\text{mA}$

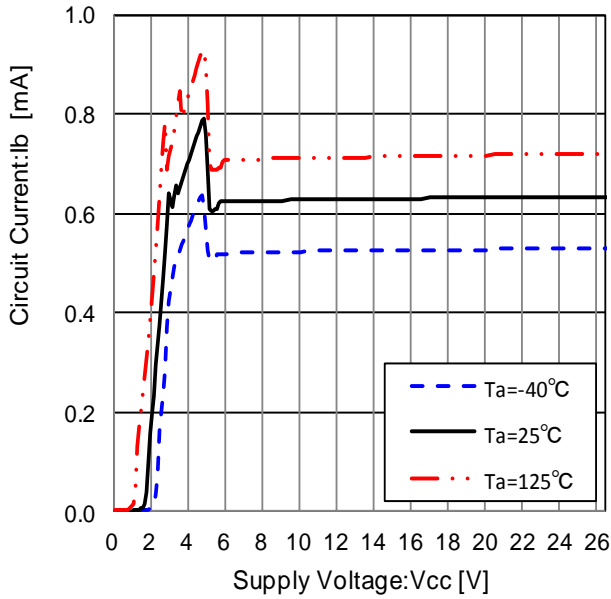

Figure 34. Circuit Current

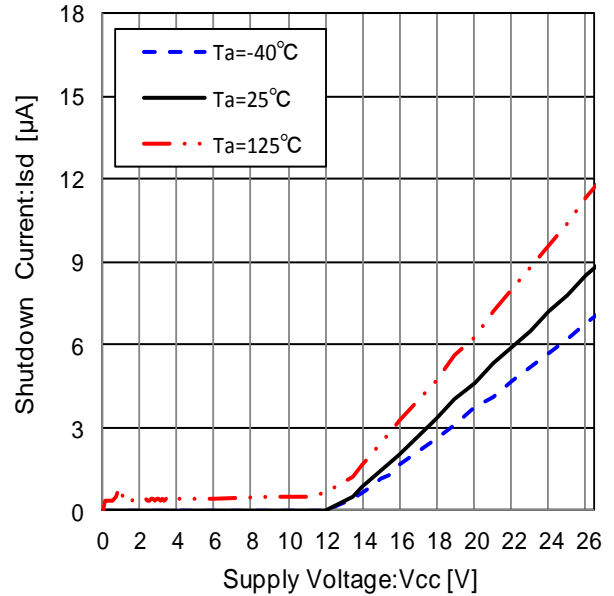

Figure 35. Shutdown Current ( $V_{CTL}=0\text{V}$ )

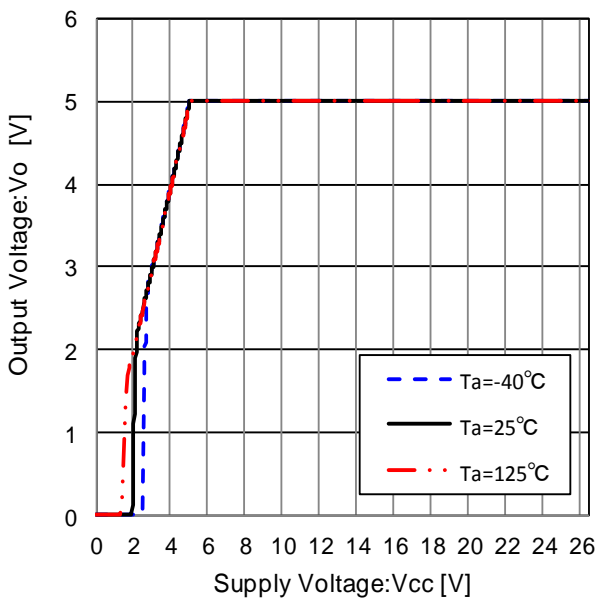

Figure 36. Line Regulation ( $I_o=0\text{mA}$ )

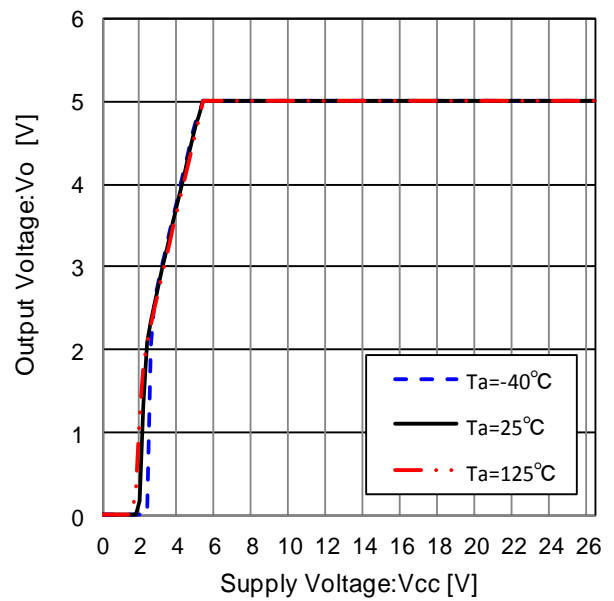

Figure 37. Line Regulation ( $I_o=500\text{mA}$ )

Reference Data - continued

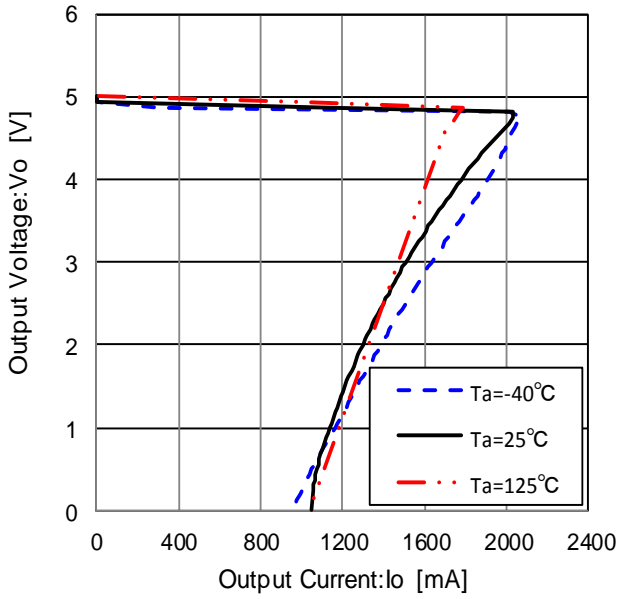

Figure 38. Load Regulation

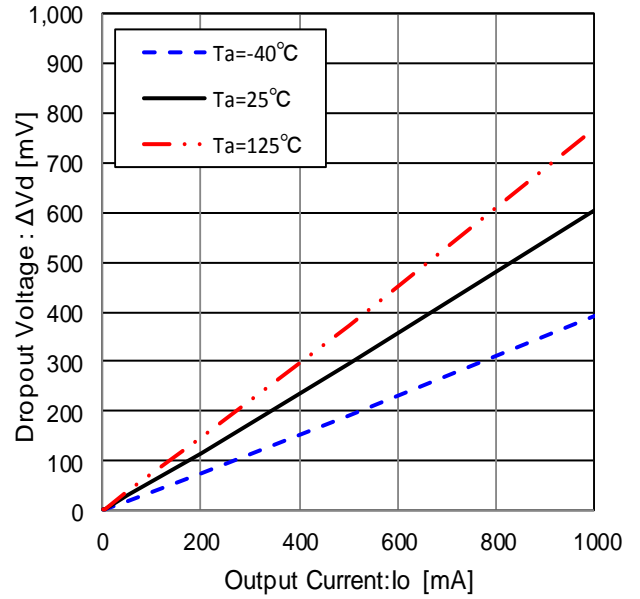

Figure 39. Dropout Voltage  
(Vcc=Vo×0.95V=4.75V)

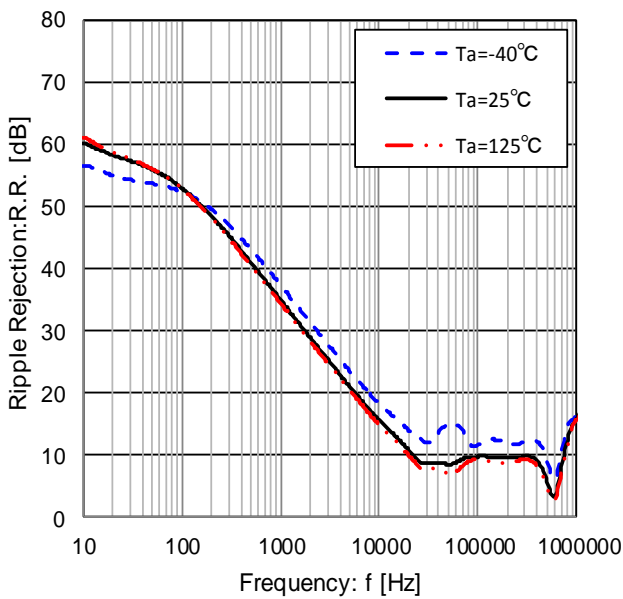

Figure 40. Ripple Rejection  
(Io=100mA)

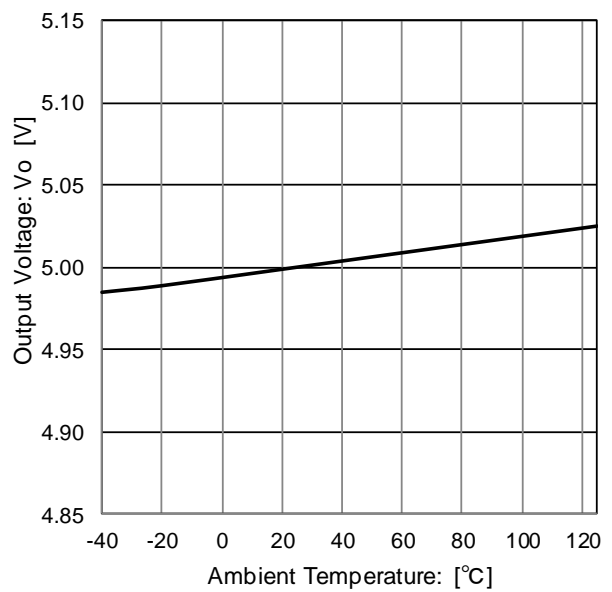

Figure 41. Output Voltage  
Temperature Characteristic

Reference Data - continued

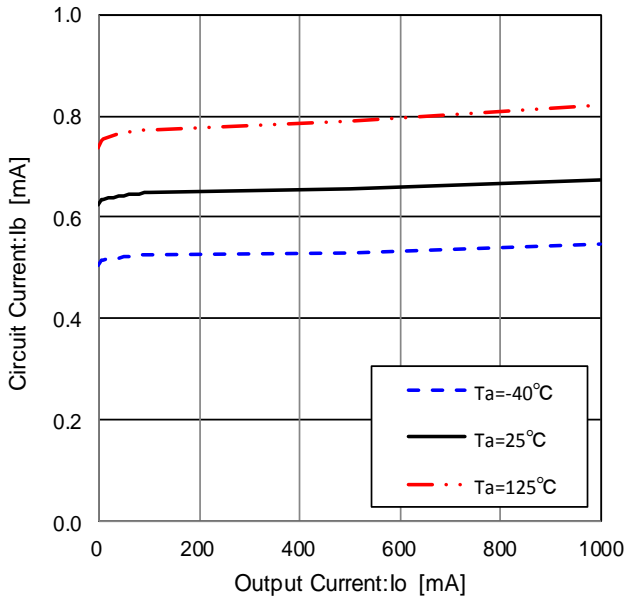

Figure 42. Circuit Current

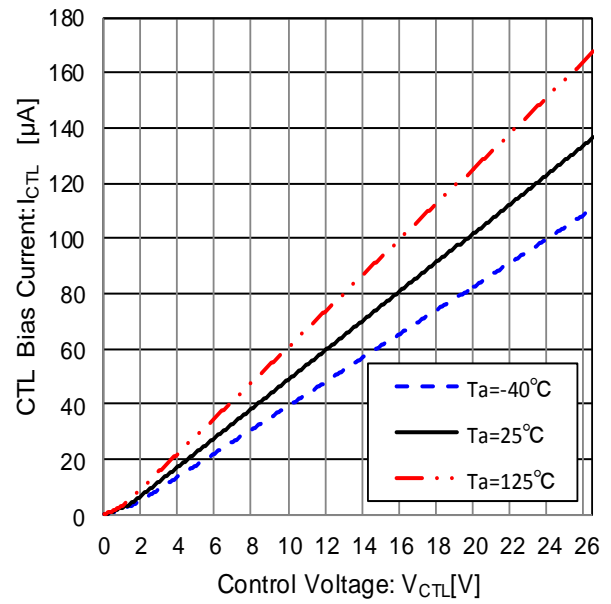

Figure 43. CTL Current vs CTL Voltage

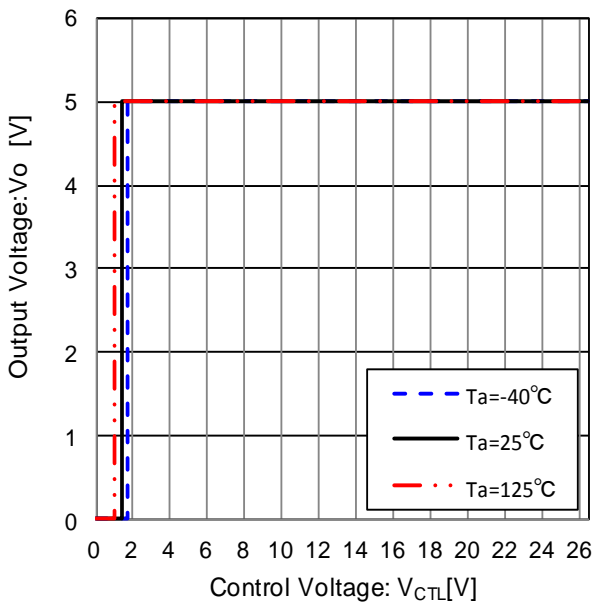

Figure 44. Output Voltage vs CTL Voltage

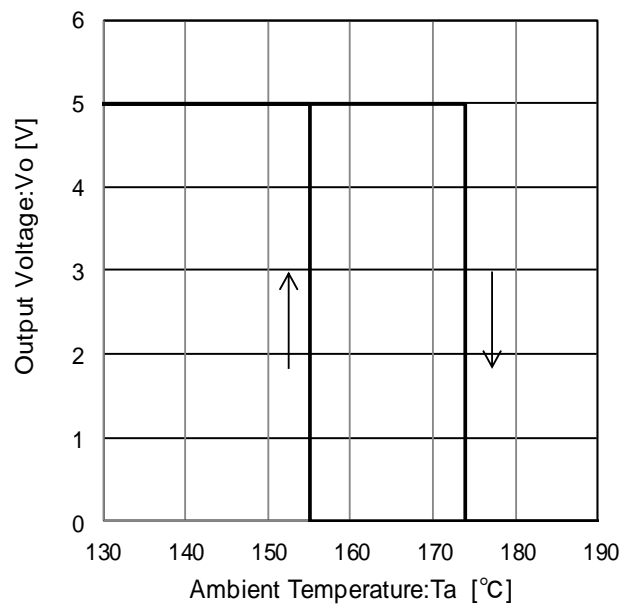

Figure 45. Thermal Shutdown Circuit Characteristic

Reference Data

■ BD80C0A-C/ BD80C0AW-C series

Unless otherwise specified,  $-40^{\circ}\text{C} \leq T_a \leq +125^{\circ}\text{C}$ ,  $V_{CC}=13.5\text{V}$ ,  $V_{CTL}=5.0\text{V}$  (With SW),  $I_o=0\text{mA}$

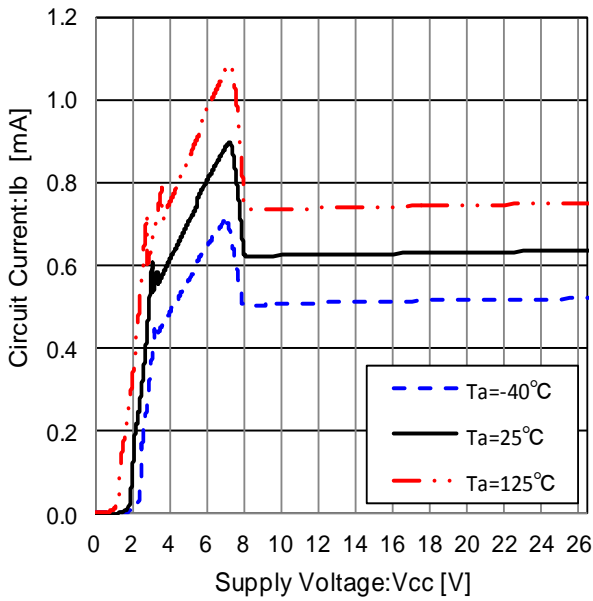

Figure 46. Circuit Current

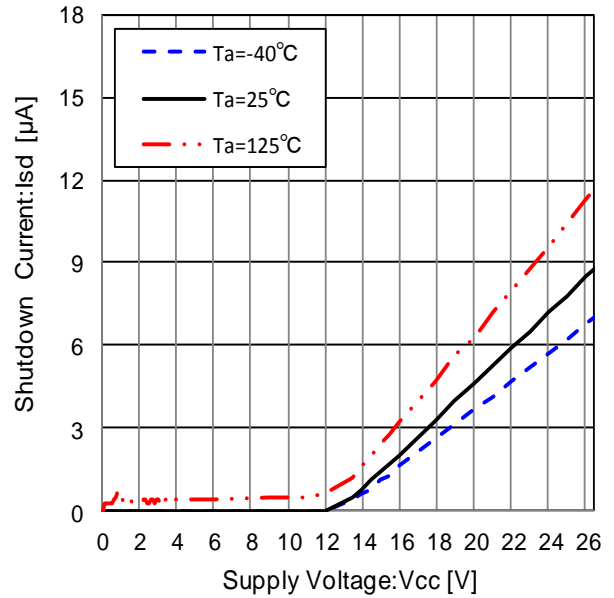

Figure 47. Shutdown Current ( $V_{CTL}=0\text{V}$ )

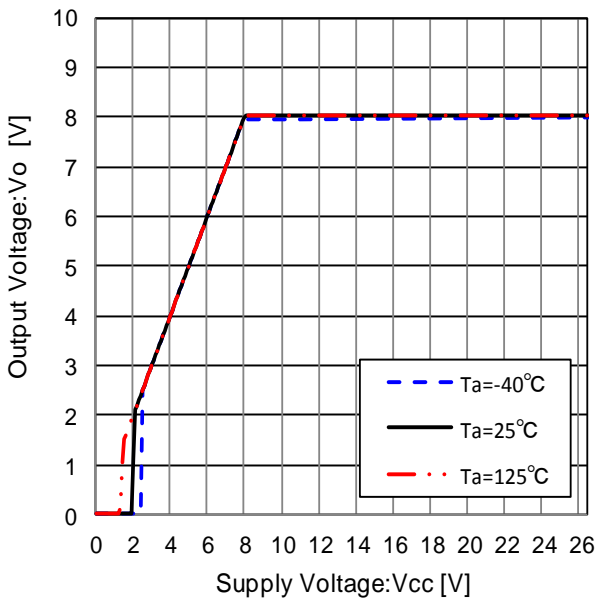

Figure 48. Line Regulation ( $I_o=0\text{mA}$ )

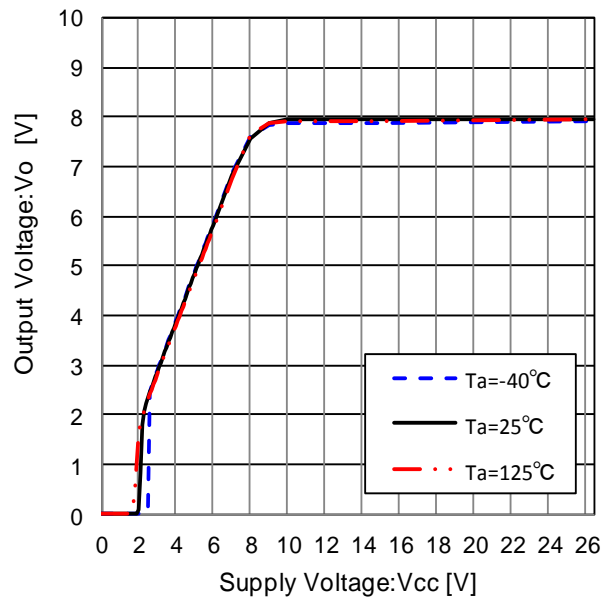

Figure 49. Line Regulation ( $I_o=500\text{mA}$ )

Reference Data - continued

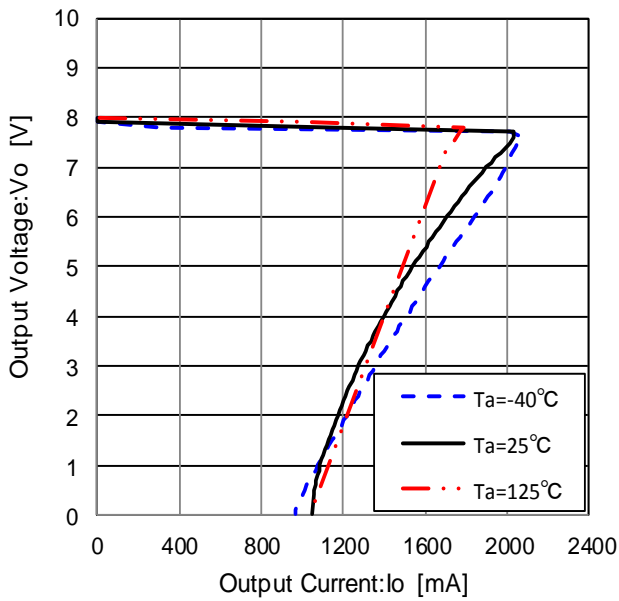

Figure 50. Load Regulation

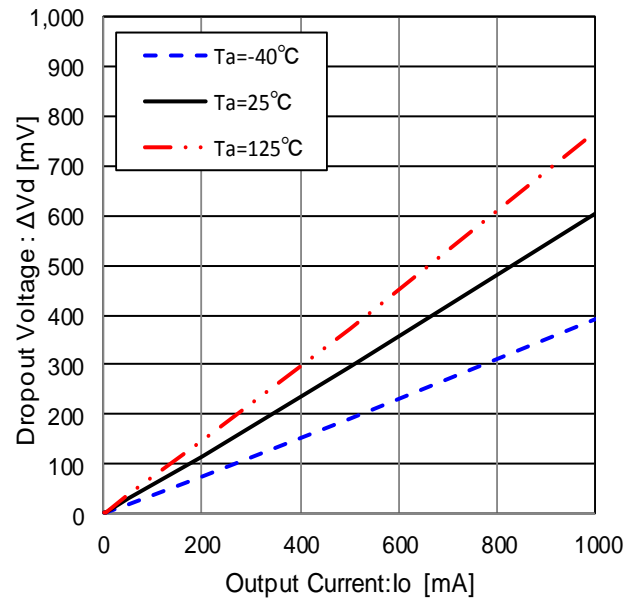

Figure 51. Dropout Voltage  
(Vcc=Vo×0.95V=7.6V)

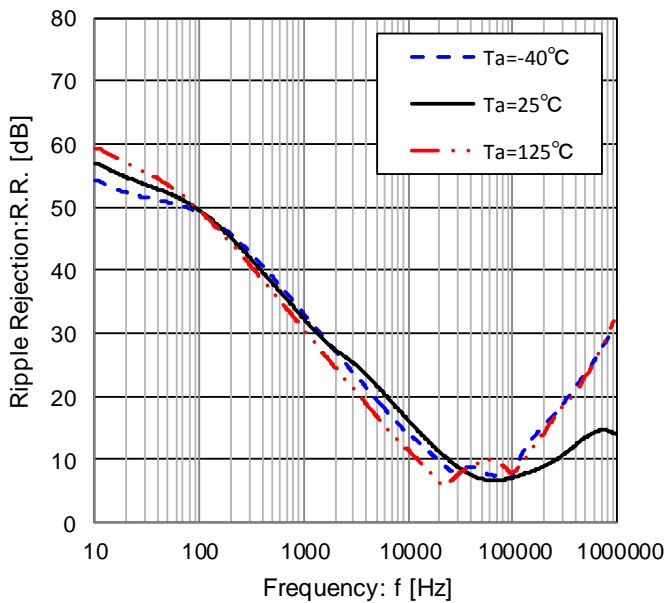

Figure 52. Ripple Rejection  
(Io=100mA)

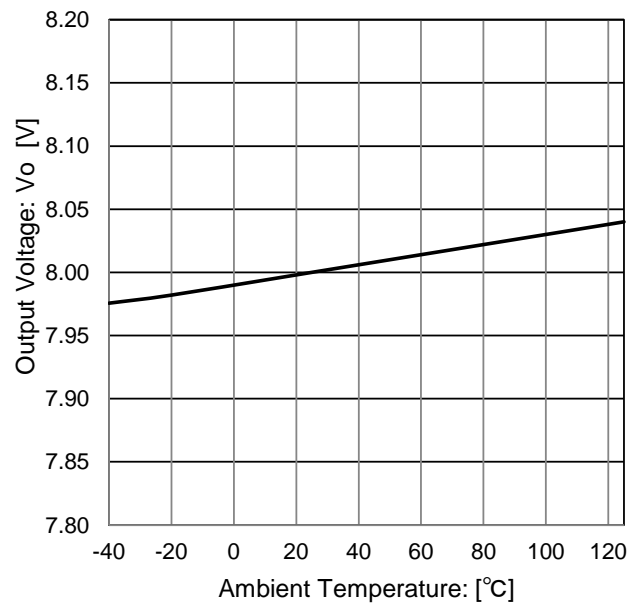

Figure 53. Output Voltage Temperature Characteristic

Reference Data - continued

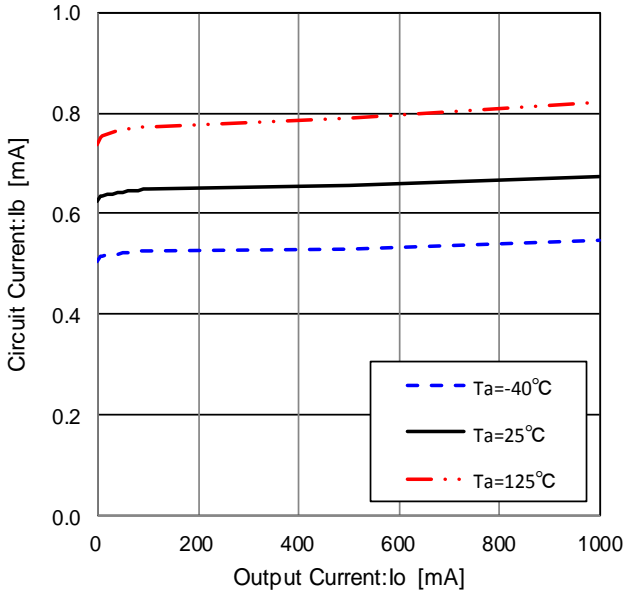

Figure 54. Circuit Current

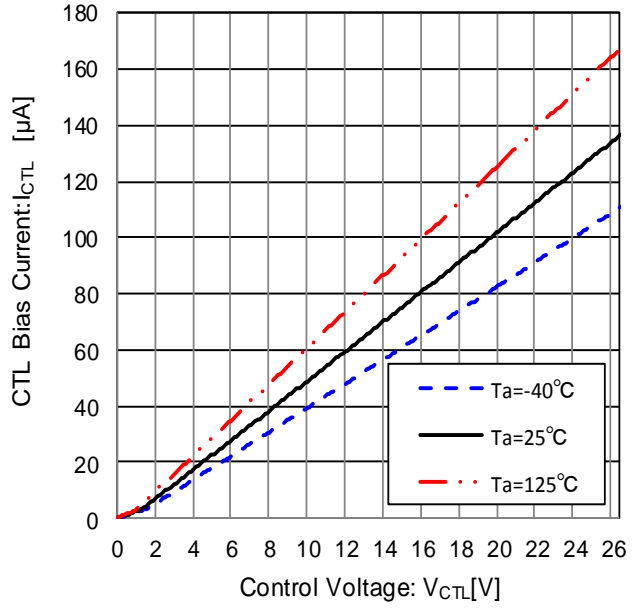

Figure 55. CTL Current vs CTL Voltage

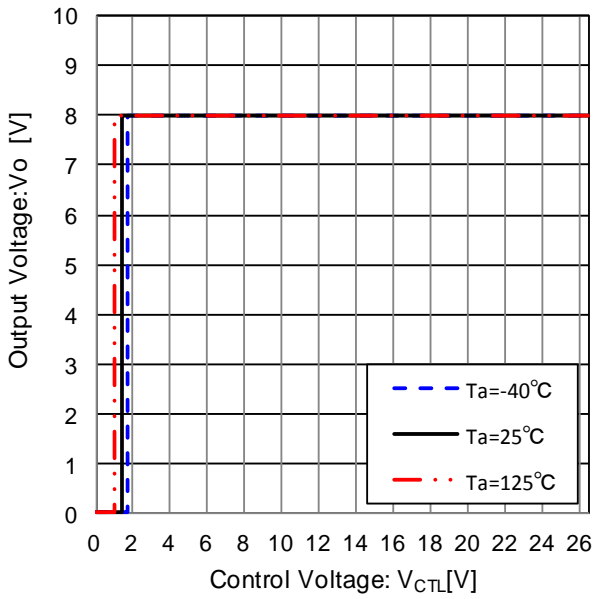

Figure 56. Output Voltage vs CTL Voltage

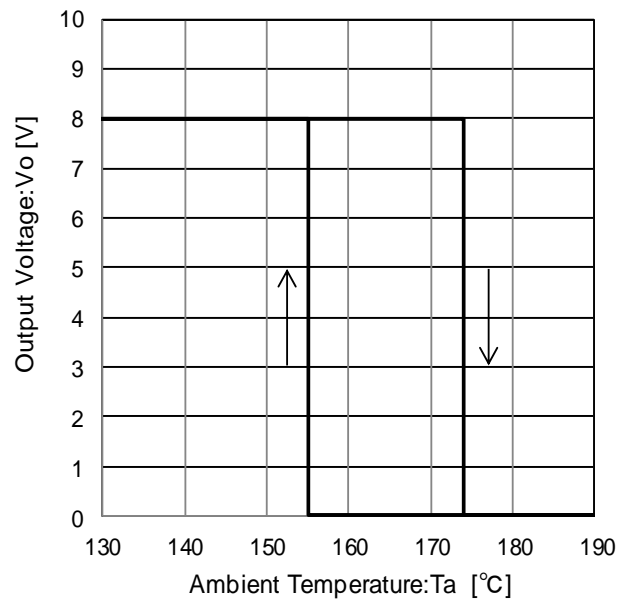

Figure 57. Thermal Shutdown Circuit Characteristic

Reference Data

■ BD90C0A-C/ BD90C0AW-C series

Unless otherwise specified,  $-40^{\circ}\text{C} \leq T_a \leq +125^{\circ}\text{C}$ ,  $V_{CC}=13.5\text{V}$ ,  $V_{CTL}=5.0\text{V}$  (With SW),  $I_o=0\text{mA}$

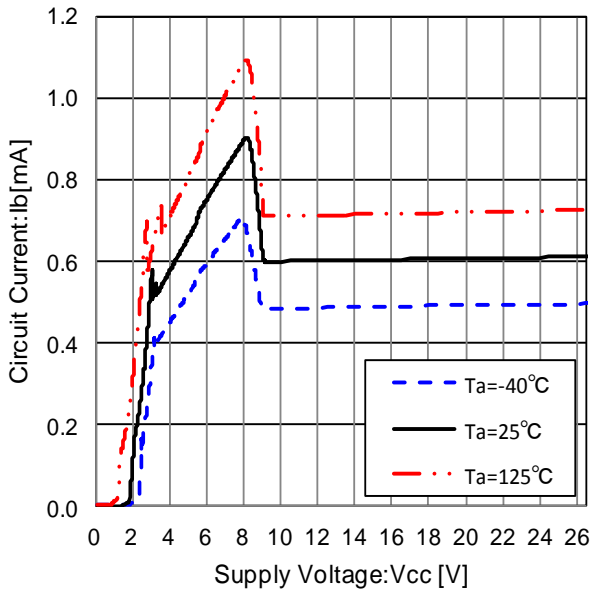

Figure 58. Circuit Current

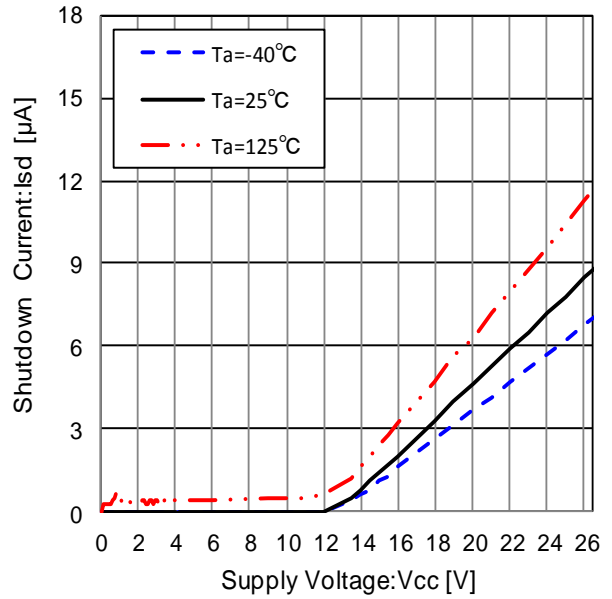

Figure 59. Shutdown Current ( $V_{CTL}=0\text{V}$ )

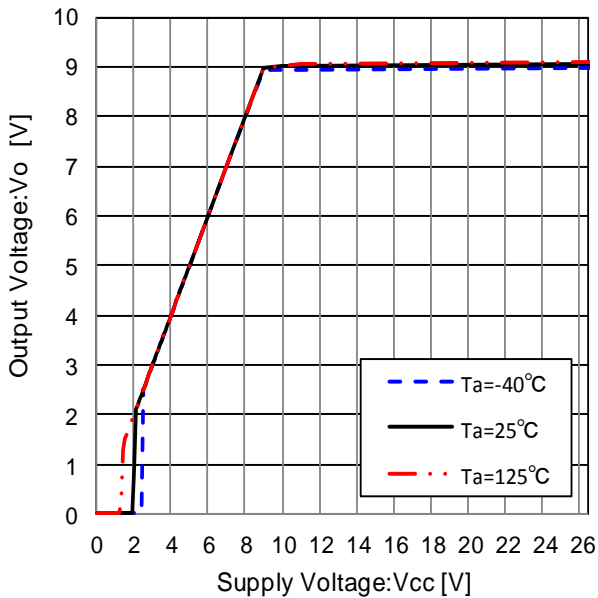

Figure 60. Line Regulation ( $I_o=0\text{mA}$ )

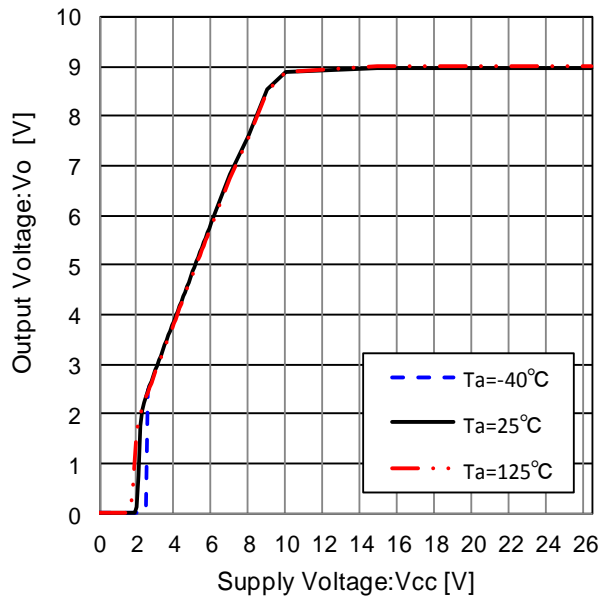

Figure 61. Line Regulation ( $I_o=500\text{mA}$ )

Reference Data - continued

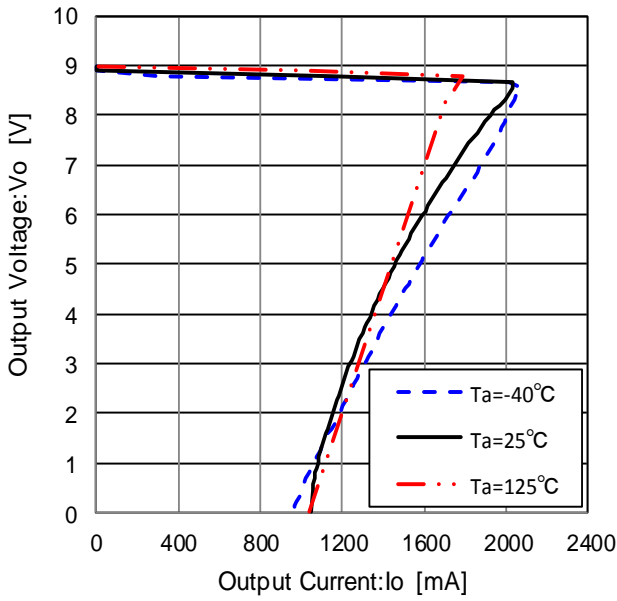

Figure 62. Load Regulation

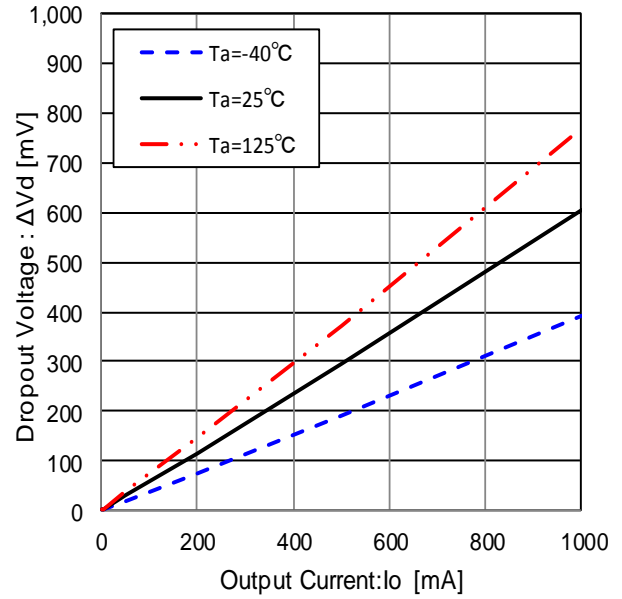

Figure 63. Dropout Voltage (Vcc=Vox0.95V=8.55V)

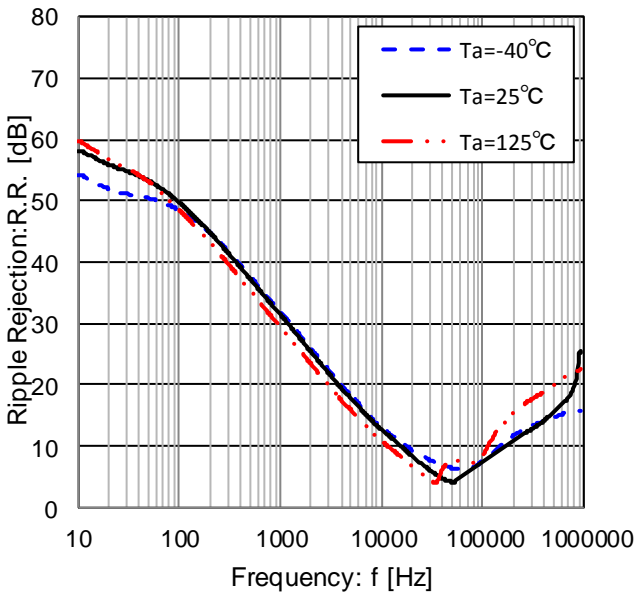

Figure 64. Ripple Rejection (Io=100mA)

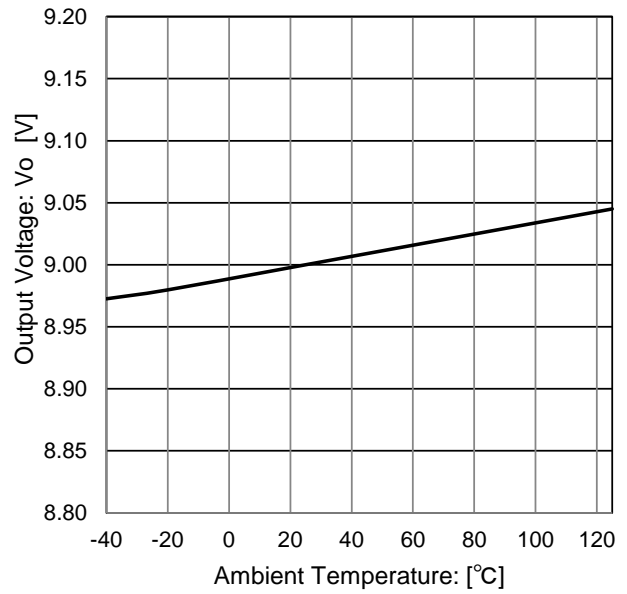

Figure 65. Output Voltage Temperature Characteristic

Reference Data - continued

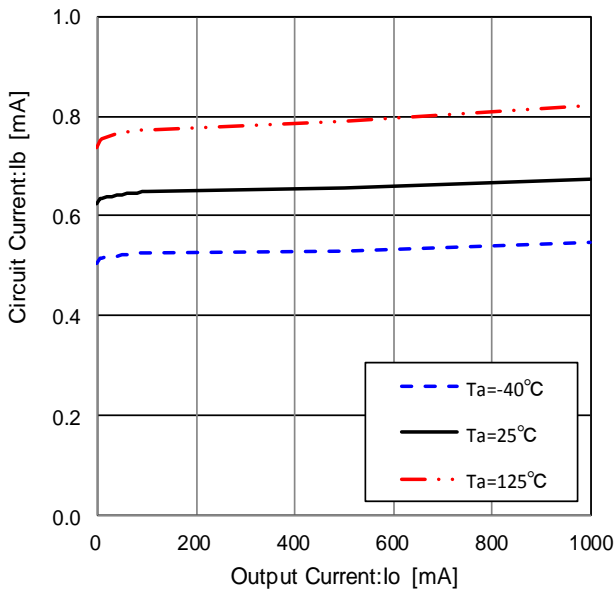

Figure 66. Circuit Current

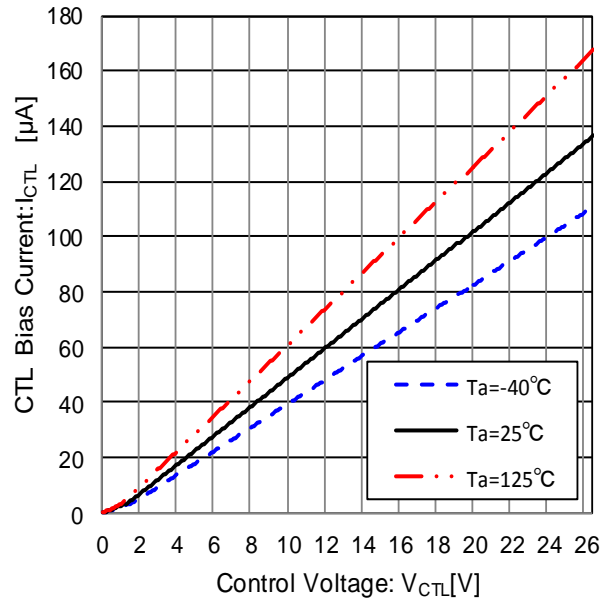

Figure 67. CTL Current vs CTL Voltage

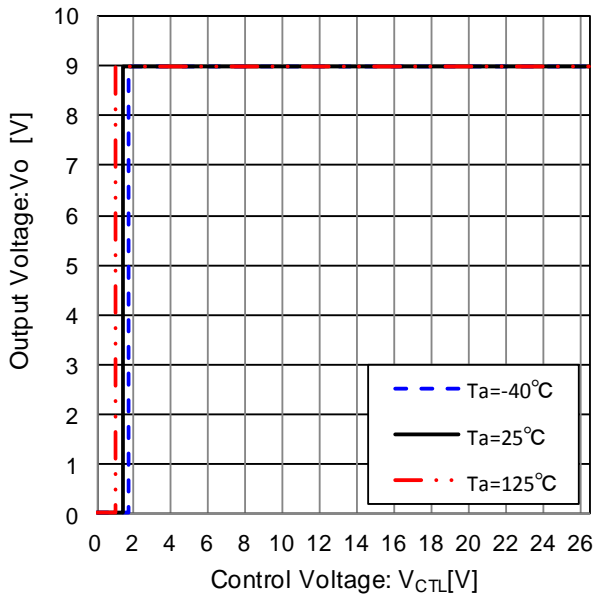

Figure 68. Output Voltage vs CTL Voltage

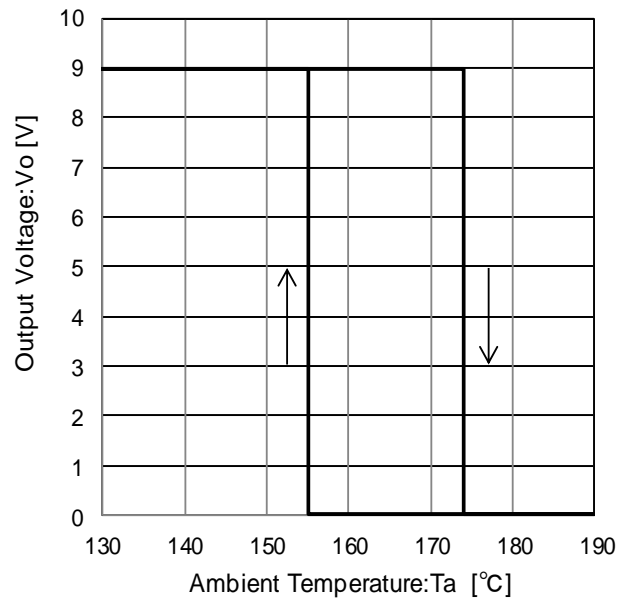
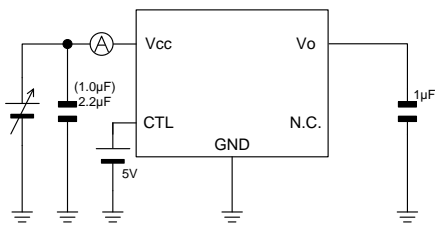

Figure 69. Thermal Shutdown Circuit Characteristic

Measurement setup for reference data

■ BDxxC0AW-C series(Output Voltage Fixation Type)



Measurement setup for Figure 23, 34, 46 and 58

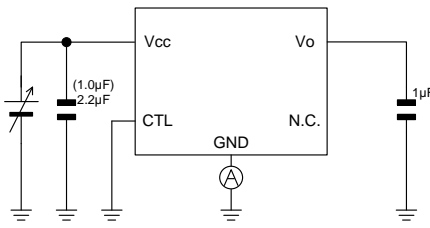

Measurement setup for Figure 24, 35, 47 and 59

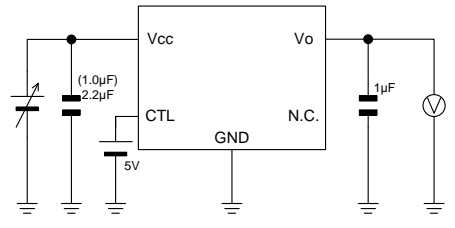

Measurement setup for Figure 25, 36, 48 and 60

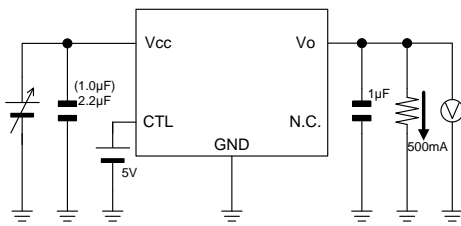

Measurement setup for Figure 26, 37, 49 and 61

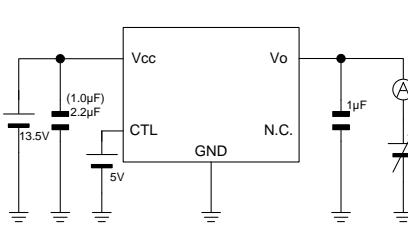

Measurement setup for Figure 27, 38, 50 and 62

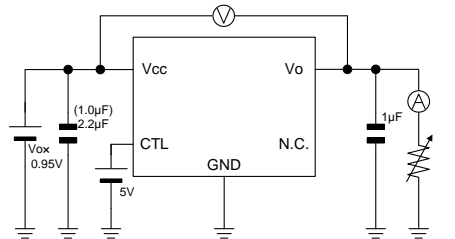

Measurement setup for Figure 39, 51 and 63

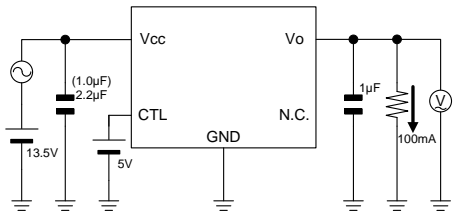

Measurement setup for Figure 28, 40, 52 and 64

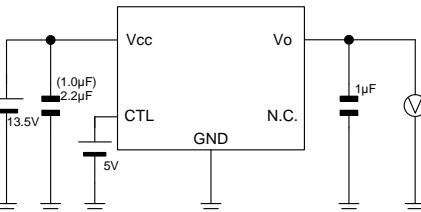

Measurement setup for Figure 29, 41, 53 and 65

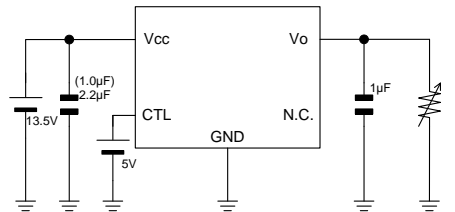

Measurement setup for Figure 30, 42, 54 and 66

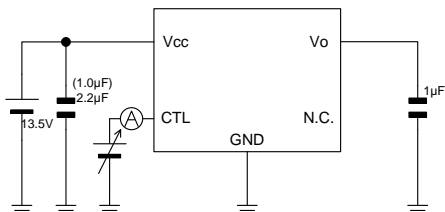

Measurement setup for Figure 31, 43, 55 and 67

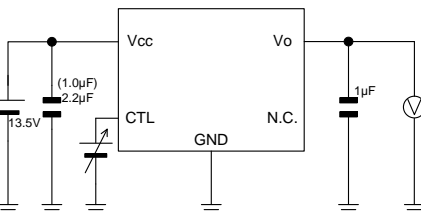

Measurement setup for Figure 32, 44, 56 and 68

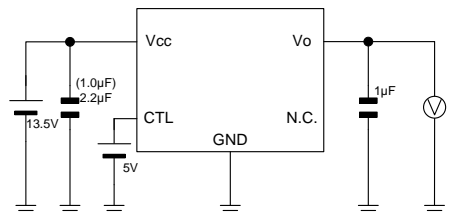

Measurement setup for Figure 33, 45, 57 and 69

**Application Examples**

- Applying positive surge to the Vcc pin  
 If the possibility exists that surges higher than 35.0V will be applied to the Vcc pin, a zenar diode should be placed between the Vcc pin and GND pin as shown in the Figure below.

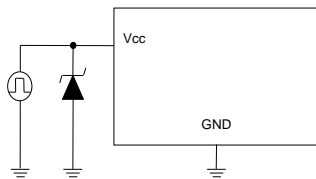

Figure 70

- Applying negative surge to the Vcc pin  
 If the possibility exists that negative surges lower than the GND are applied to the Vcc pin, a schottky diode should be placed between the Vcc pin and GND pin as shown in the Figure below.

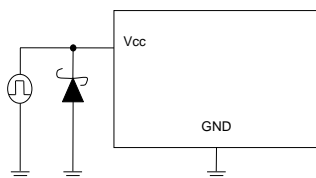

Figure 71

- Implementing a protection diode  
 If the possibility exists that a large inductive load is connected to the output pin resulting in back-EMF at time of startup and Shutdown, a protection diode should be placed as shown in the Figure below.

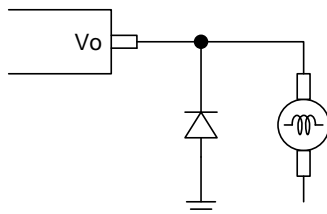

Figure 72

Thermal Design

■ TO252-3

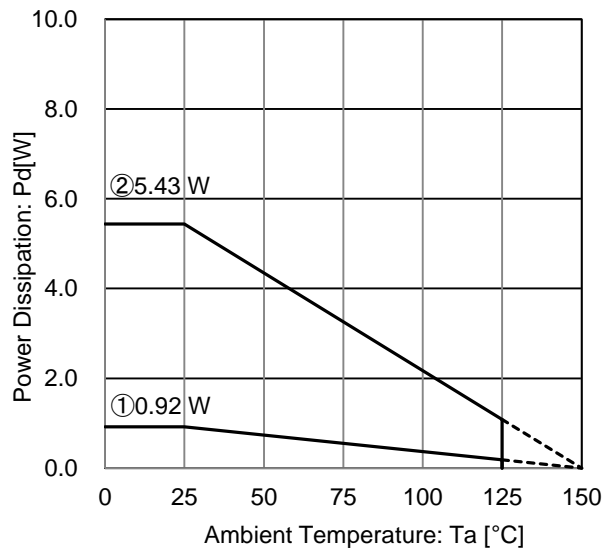

Figure 73. TO252-3 Package Data

IC mounted on ROHM standard board based on JEDEC.

- ① : 1 - layer PCB  
 (Copper foil area on the reverse side of PCB: 0 mm x 0 mm)  
 Board material: FR4  
 Board size: 114.3 mm x 76.2 mm x 1.57 mm  
 Mount condition: PCB and exposed pad are soldered.  
 Top copper foil: ROHM recommended footprint + wiring to measure, 2 oz. copper.
- ② : 4 - layer PCB  
 (2 inner layers and Copper foil area on the reverse side of PCB: 74.2 mm x 74.2 mm)  
 Board material: FR4  
 Board size: 114.3 mm x 76.2 mm x 1.60 mm  
 Mount condition: PCB and exposed pad are soldered.  
 Top copper foil: ROHM recommended footprint + wiring to measure, 2 oz. copper.  
 2 inner layers copper foil area of PCB : 74.2 mm x 74.2 mm, 1 oz. copper.  
 Copper foil area on the reverse side of PCB : 74.2 mm x 74.2 mm, 2 oz. copper.

Condition①:  $\theta_{JA} = 81 \text{ }^\circ\text{C} / \text{W}$ ,  $\Psi_{JT}$  (top center) =  $8 \text{ }^\circ\text{C} / \text{W}$   
 Condition②:  $\theta_{JA} = 21 \text{ }^\circ\text{C} / \text{W}$ ,  $\Psi_{JT}$  (top center) =  $2 \text{ }^\circ\text{C} / \text{W}$

■ TO252-5

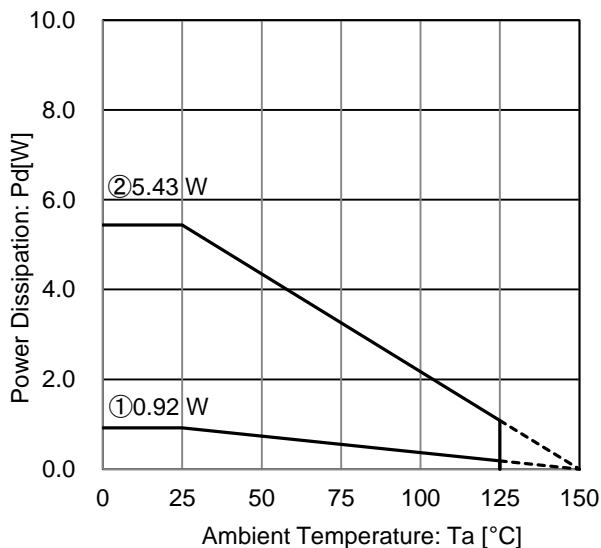

Figure 74. TO252-5 Package Data

IC mounted on ROHM standard board based on JEDEC.

- ① : 1 - layer PCB  
 (Copper foil area on the reverse side of PCB: 0 mm x 0 mm)  
 Board material: FR4  
 Board size: 114.3 mm x 76.2 mm x 1.57 mm  
 Mount condition: PCB and exposed pad are soldered.  
 Top copper foil: ROHM recommended footprint + wiring to measure, 2 oz. copper.
- ② : 4 - layer PCB  
 (2 inner layers and Copper foil area on the reverse side of PCB: 74.2 mm x 74.2 mm)  
 Board material: FR4  
 Board size: 114.3 mm x 76.2 mm x 1.60 mm  
 Mount condition: PCB and exposed pad are soldered.  
 Top copper foil: ROHM recommended footprint + wiring to measure, 2 oz. copper.  
 2 inner layers copper foil area of PCB : 74.2 mm x 74.2 mm, 1 oz. copper.  
 Copper foil area on the reverse side of PCB : 74.2 mm x 74.2 mm, 2 oz. copper.

Condition①:  $\theta_{JA} = 136 \text{ }^\circ\text{C} / \text{W}$ ,  $\Psi_{JT}$  (top center) =  $17 \text{ }^\circ\text{C} / \text{W}$   
 Condition②:  $\theta_{JA} = 23 \text{ }^\circ\text{C} / \text{W}$ ,  $\Psi_{JT}$  (top center) =  $3 \text{ }^\circ\text{C} / \text{W}$

Thermal Design – continued

■ HRP5

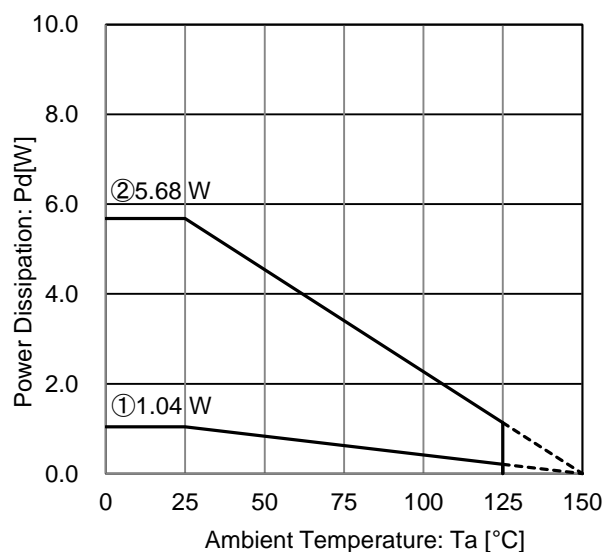

Figure 75. HRP5 Package Data

IC mounted on ROHM standard board based on JEDEC.

① : 1 - layer PCB  
 (Copper foil area on the reverse side of PCB: 0 mm x 0 mm)  
 Board material: FR4  
 Board size: 114.3 mm x 76.2 mm x 1.57 mm  
 Mount condition: PCB and exposed pad are soldered.  
 Top copper foil: ROHM recommended footprint + wiring to measure, 2 oz. copper.

② : 4 - layer PCB  
 (2 inner layers and Copper foil area on the reverse side of PCB: 74.2 mm x 74.2 mm)  
 Board material: FR4  
 Board size: 114.3 mm x 76.2 mm x 1.60 mm  
 Mount condition: PCB and exposed pad are soldered.  
 Top copper foil: ROHM recommended footprint + wiring to measure, 2 oz. copper.  
 2 inner layers copper foil area of PCB : 74.2 mm x 74.2 mm, 1 oz. copper.  
 Copper foil area on the reverse side of PCB : 74.2 mm x 74.2 mm, 2 oz. copper.

Condition①:  $\theta_{JA} = 120 \text{ }^\circ\text{C} / \text{W}$ ,  $\Psi_{JT} \text{ (top center)} = 8 \text{ }^\circ\text{C} / \text{W}$

Condition②:  $\theta_{JA} = 22 \text{ }^\circ\text{C} / \text{W}$ ,  $\Psi_{JT} \text{ (top center)} = 3 \text{ }^\circ\text{C} / \text{W}$

Thermal Design – continued

■ TO263-3(F)

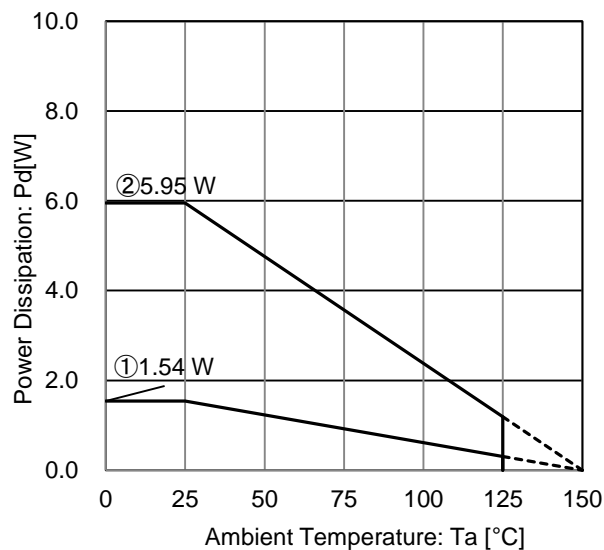

Figure 76. TO263-3 Package Data

IC mounted on ROHM standard board based on JEDEC.

① : 1 - layer PCB  
 (Copper foil area on the reverse side of PCB: 0 mm x 0 mm)  
 Board material: FR4  
 Board size: 114.3 mm x 76.2 mm x 1.57 mm  
 Mount condition: PCB and exposed pad are soldered.  
 Top copper foil: ROHM recommended footprint + wiring to measure, 2 oz. copper.

② : 4 - layer PCB  
 (2 inner layers and Copper foil area on the reverse side of PCB: 74.2 mm x 74.2 mm)  
 Board material: FR4  
 Board size: 114.3 mm x 76.2 mm x 1.60 mm  
 Mount condition: PCB and exposed pad are soldered.  
 Top copper foil: ROHM recommended footprint + wiring to measure, 2 oz. copper.  
 2 inner layers copper foil area of PCB : 74.2 mm x 74.2 mm, 1 oz. copper.  
 Copper foil area on the reverse side of PCB : 74.2 mm x 74.2 mm, 2 oz. copper.

Condition①:  $\theta_{JA} = 81 \text{ }^\circ\text{C} / \text{W}$ ,  $\Psi_{JT}$  (top center) =  $8 \text{ }^\circ\text{C} / \text{W}$

Condition②:  $\theta_{JA} = 21 \text{ }^\circ\text{C} / \text{W}$ ,  $\Psi_{JT}$  (top center) =  $2 \text{ }^\circ\text{C} / \text{W}$

■ TO263-5

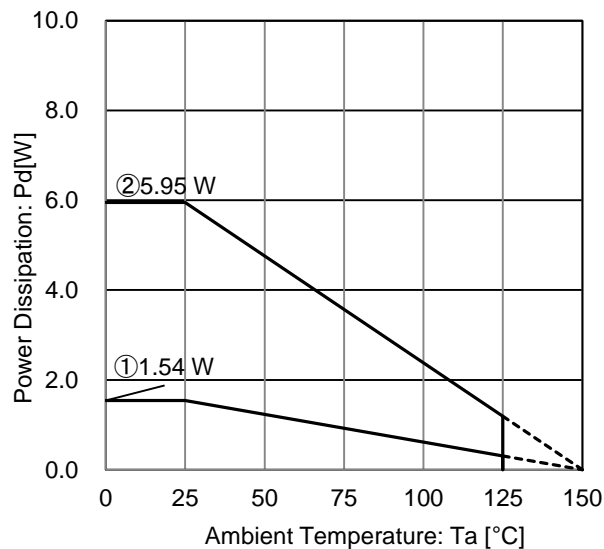

Figure 77. TO263-5 Package Data

IC mounted on ROHM standard board based on JEDEC.

① : 1 - layer PCB  
 (Copper foil area on the reverse side of PCB: 0 mm x 0 mm)  
 Board material: FR4  
 Board size: 114.3 mm x 76.2 mm x 1.57 mm  
 Mount condition: PCB and exposed pad are soldered.  
 Top copper foil: ROHM recommended footprint + wiring to measure, 2 oz. copper.

② : 4 - layer PCB  
 (2 inner layers and Copper foil area on the reverse side of PCB: 74.2 mm x 74.2 mm)  
 Board material: FR4  
 Board size: 114.3 mm x 76.2 mm x 1.60 mm  
 Mount condition: PCB and exposed pad are soldered.  
 Top copper foil: ROHM recommended footprint + wiring to measure, 2 oz. copper.  
 2 inner layers copper foil area of PCB : 74.2 mm x 74.2 mm, 1 oz. copper.  
 Copper foil area on the reverse side of PCB : 74.2 mm x 74.2 mm, 2 oz. copper.

Condition①:  $\theta_{JA} = 81 \text{ }^\circ\text{C} / \text{W}$ ,  $\Psi_{JT}$  (top center) =  $8 \text{ }^\circ\text{C} / \text{W}$

Condition②:  $\theta_{JA} = 21 \text{ }^\circ\text{C} / \text{W}$ ,  $\Psi_{JT}$  (top center) =  $2 \text{ }^\circ\text{C} / \text{W}$

When operating at temperature more than  $T_a=25^{\circ}\text{C}$ , please refer to the power dissipation characteristic curve shown in Figure 73 to 77.

The IC characteristics are closely related to the temperature at which the IC is used, so it is necessary to operate the IC at temperatures less than the maximum junction temperature  $T_{j\text{max}}$ .

Figure. 73 to 77 shows the acceptable power dissipation characteristic curves of the TO252-3/5, HRP5 and TO263-3(F)/5 packages. Even when the ambient temperature ( $T_a$ ) is at normal temperature ( $25^{\circ}\text{C}$ ), the chip junction temperature ( $T_j$ ) may be quite high so please operate the IC at temperatures less than the acceptable power dissipation.

The calculation method for power consumption  $P_c(\text{W})$  is as follows

$$P_c = (V_{cc} - V_o) \times I_o + V_{cc} \times I_b$$

$$\text{Acceptable loss } P_d \geq P_c$$

Solving this for load current  $I_o$  in order to operate within the acceptable loss

$V_{cc}$  : Input voltage  
 $V_o$  : Output voltage  
 $I_o$  : Load current  
 $I_b$  : Circuit current

$$I_o \leq \frac{P_d - V_{cc} \times I_b}{V_{cc} - V_o} \quad (\text{Please refer to 19, 30, 42, 54 and 66 about } I_b.)$$

It is then possible to find the maximum load current  $I_{o\text{max}}$  with respect to the applied voltage  $V_{cc}$  at the time of thermal design.

Calculation Example) When TO252-3 / TO252-5, 4-layer PCB,  $T_a=85^{\circ}\text{C}$ ,  $V_{cc}=13.5\text{V}$ ,  $V_o=5.0\text{V}$

$$I_o \leq \frac{2.824 - 13.5 \times I_b}{8.5} \quad \left( \begin{array}{l} \text{Figure 73, 74 } @\theta_{ja}=23^{\circ}\text{C/W} \rightarrow -43.5\text{mW}/^{\circ}\text{C} \\ 25^{\circ}\text{C} = 5.43\text{W} \rightarrow 85^{\circ}\text{C} = 2.824\text{W} \end{array} \right)$$

$$I_o \leq 331.3\text{mA} \quad (I_b : 0.6\text{mA})$$

Calculation Example) When HRP5, 4-layer PCB,  $T_a=85^{\circ}\text{C}$ ,  $V_{cc}=13.5\text{V}$ ,  $V_o=5.0\text{V}$

$$I_o \leq \frac{2.954 - 13.5 \times I_b}{8.5} \quad \left( \begin{array}{l} \text{Figure 75 } @\theta_{ja}=22^{\circ}\text{C/W} \rightarrow -45.5\text{mW}/^{\circ}\text{C} \\ 25^{\circ}\text{C} = 5.68\text{W} \rightarrow 85^{\circ}\text{C} = 2.954\text{W} \end{array} \right)$$

$$I_o \leq 346.6\text{mA} \quad (I_b : 0.6\text{mA})$$

Calculation Example) When TO263-3(F) / TO263-5, 4-layer PCB,  $T_a=85^{\circ}\text{C}$ ,  $V_{cc}=13.5\text{V}$ ,  $V_o=5.0\text{V}$

$$I_o \leq \frac{3.094 - 13.5 \times I_b}{8.5} \quad \left( \begin{array}{l} \text{Figure 76, 77 } @\theta_{ja}=21^{\circ}\text{C/W} \rightarrow -47.6\text{mW}/^{\circ}\text{C} \\ 25^{\circ}\text{C} = 5.95\text{W} \rightarrow 85^{\circ}\text{C} = 3.094\text{W} \end{array} \right)$$

$$I_o \leq 363\text{mA} \quad (I_b : 0.6\text{mA})$$

Please refer to the above information and keep thermal designs within the scope of acceptable loss for all operating temperature ranges.

I/O equivalence circuit

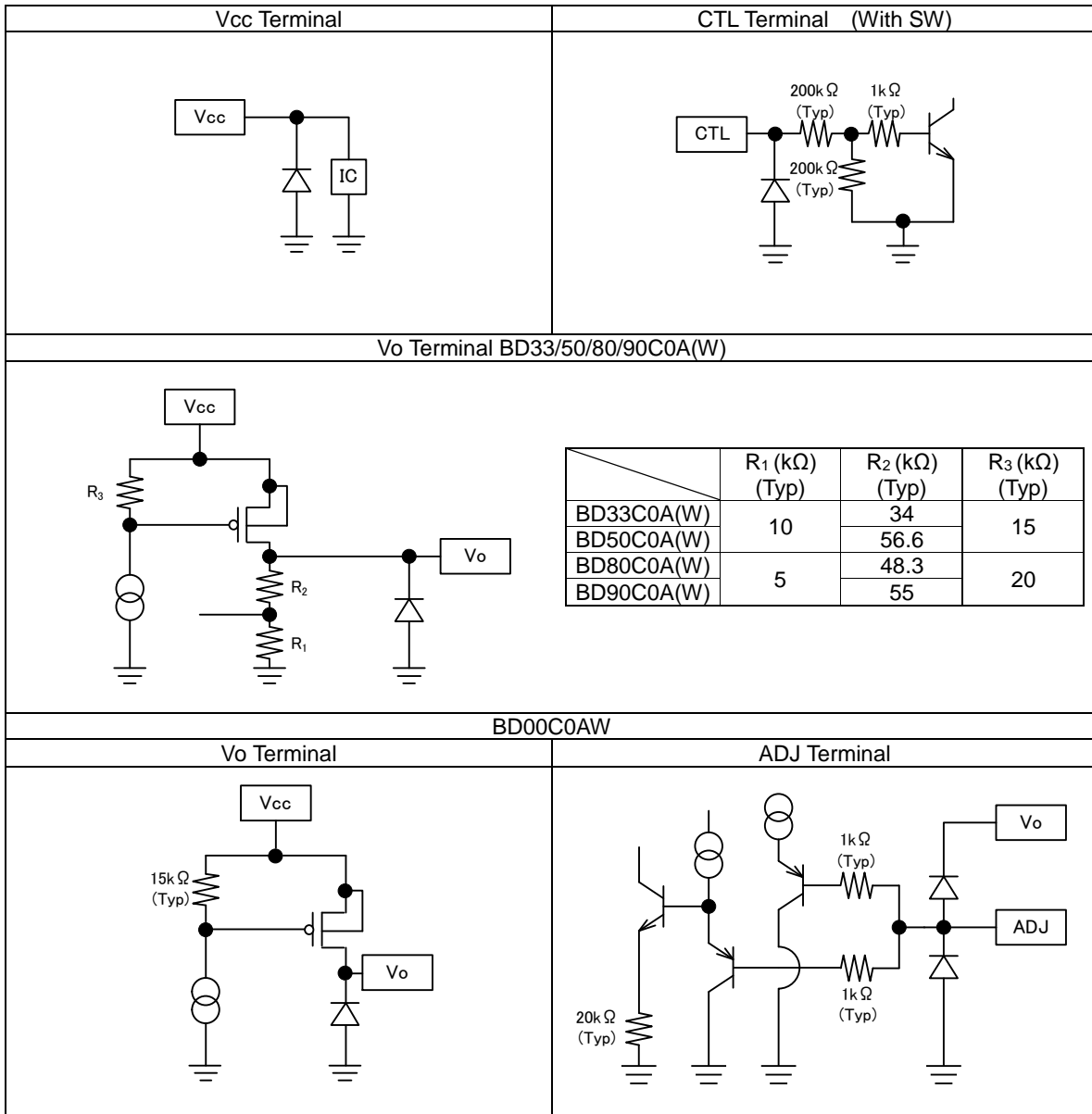
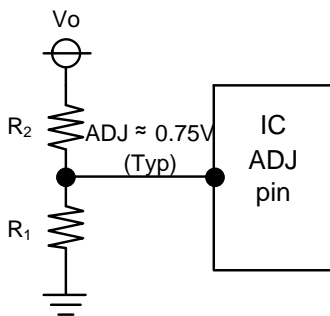

Figure 78

Output Voltage Configuration Method (BD00C0AW)

Please connect resistors R<sub>1</sub> and R<sub>2</sub> (which determines the output voltage) as shown in Figure 79.

Please be aware that the offset due to the current that flows from the ADJ terminal becomes large when resistor values are large. Due to this, resistance ranging from 5kΩ to 10kΩ is highly recommended for R<sub>1</sub>.



$$V_o \approx \text{ADJ} \times (R_1 + R_2) / R_1$$

The circuit current depends on the resistance value of R<sub>1</sub> and R<sub>2</sub>. Please determine the constant considering the actual application.

Figure 79

## Operational Notes

### 1. Reverse Connection of Power Supply

Connecting the power supply in reverse polarity can damage the IC. Take precautions against reverse polarity when connecting the power supply, such as mounting an external diode between the power supply and the IC's power supply pins.

### 2. Power Supply Lines

Design the PCB layout pattern to provide low impedance supply lines. Separate the ground and supply lines of the digital and analog blocks to prevent noise in the ground and supply lines of the digital block from affecting the analog block. Furthermore, connect a capacitor to ground at all power supply pins. Consider the effect of temperature and aging on the capacitance value when using electrolytic capacitors.

### 3. Ground Voltage

Ensure that no pins are at a voltage below that of the ground pin at any time, even during transient condition.

### 4. Ground Wiring Pattern

When using both small-signal and large-current ground traces, the two ground traces should be routed separately but connected to a single ground at the reference point of the application board to avoid fluctuations in the small-signal ground caused by large currents. Also ensure that the ground traces of external components do not cause variations on the ground voltage. The ground lines must be as short and thick as possible to reduce line impedance.

### 5. Thermal Consideration

Should by any chance the power dissipation rating be exceeded the rise in temperature of the chip may result in deterioration of the properties of the chip. Power dissipation in the Thermal Design is the value when the IC is mounted on a 114.3mm x 76.2mm x 1.57mm/1.6mm glass epoxy board. And in case this exceeds, take the measures like enlarge the size of board; make copper foil area for heat dissipation big; and do not exceed the power dissipation.

### 6. Inrush Current

When power is first supplied to the IC, it is possible that the internal logic may be unstable and inrush current may flow instantaneously due to the internal powering sequence and delays, especially if the IC has more than one power supply. Therefore, give special consideration to power coupling capacitance, power wiring, width of ground wiring, and routing of connections.

### 7. Testing on Application Boards

When testing the IC on an application board, connecting a capacitor directly to a low-impedance output pin may subject the IC to stress. Always discharge capacitors completely after each process or step. The IC's power supply should always be turned off completely before connecting or removing it from the test setup during the inspection process. To prevent damage from static discharge, ground the IC during assembly and use similar precautions during transport and storage.

### 8. Inter-pin Short and Mounting Errors

Ensure that the direction and position are correct when mounting the IC on the PCB. Incorrect mounting may result in damaging the IC. Avoid nearby pins being shorted to each other especially to ground, power supply and output pin. Inter-pin shorts could be due to many reasons such as metal particles, water droplets (in very humid environment) and unintentional solder bridge deposited in between pins during assembly to name a few.

### 9. Unused Input Pins

Input pins of an IC are often connected to the gate of a MOS transistor. The gate has extremely high impedance and extremely low capacitance. If left unconnected, the electric field from the outside can easily charge it. The small charge acquired in this way is enough to produce a significant effect on the conduction through the transistor and cause unexpected operation of the IC. So unless otherwise specified, unused input pins should be connected to the power supply or ground line.

Operational Notes – continued

10. Regarding the Input Pin of the IC

This monolithic IC contains P+ isolation and P substrate layers between adjacent elements in order to keep them isolated. P-N junctions are formed at the intersection of the P layers with the N layers of other elements, creating a parasitic diode or transistor. For example (refer to figure below):

When GND > Pin A and GND > Pin B, the P-N junction operates as a parasitic diode.  
 When GND > Pin B, the P-N junction operates as a parasitic transistor.

Parasitic diodes inevitably occur in the structure of the IC. The operation of parasitic diodes can result in mutual interference among circuits, operational faults, or physical damage. Therefore, conditions that cause these diodes to operate, such as applying a voltage lower than the GND voltage to an input pin (and thus to the P substrate) should be avoided.

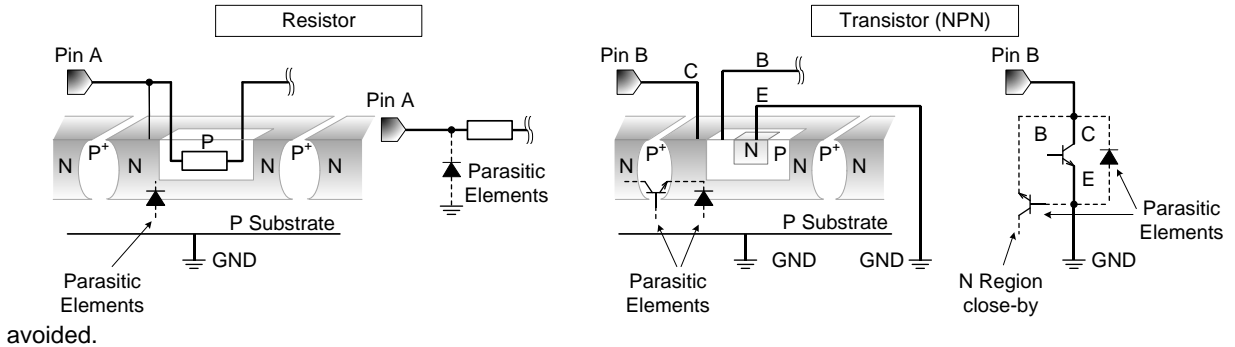

11. Ceramic Capacitor

When using a ceramic capacitor, determine the dielectric constant considering the change of capacitance with temperature and the decrease in nominal capacitance due to DC bias and others.

12. Thermal Shutdown Circuit(TSD)

This IC has a built-in thermal shutdown circuit that prevents heat damage to the IC. Normal operation should always be within the IC's power dissipation rating. If however the rating is exceeded for a continued period, the junction temperature (Tj) will rise which will activate the TSD circuit that will turn OFF all output pins. When the Tj falls below the TSD threshold, the circuits are automatically restored to normal operation.

Note that the TSD circuit operates in a situation that exceeds the absolute maximum ratings and therefore, under no circumstances, should the TSD circuit be used in a set design or for any purpose other than protecting the IC from heat damage.

13. Over Current Protection Circuit (OCP)

This IC incorporates an integrated overcurrent protection circuit that is activated when the load is shorted. This protection circuit is effective in preventing damage due to sudden and unexpected incidents. However, the IC should not be used in applications characterized by continuous operation or transitioning of the protection circuit.

14. Vcc Pin

Insert a capacitor (Vo ≥ 5.0V:capacitor ≥ 1μF, 1.0 ≤ Vo < 5.0V:capacitor ≥ 2.2μF) between the Vcc and GND pins. Choose the capacitance according to the line between the power smoothing circuit and the Vcc pin. Selection of the capacitance also depends on the application. Verify the application and allow for sufficient margins in the design. We recommend using a capacitor with excellent voltage and temperature characteristics.

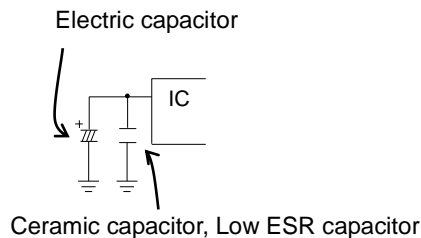

Operational Notes – continued

15. Output Pin

In order to prevent oscillation, a capacitor needs to be placed between the output pin and GND pin. We recommend a capacitor with a capacitance of more than 1µF(3.0V ≤ Vo ≤ 15.0V). Electrolytic, tantalum and ceramic capacitors can be used. We recommend a capacitor with a capacitance of more than 4.7µF(1.0V ≤ Vo < 3.0V). Ceramic capacitors can be used. If electrolytic and tantalum capacitors of more than 4.7µF with a high ESR characteristic are used(1.0V ≤ Vo < 3.0V), 10 µF ceramic capacitor needs to be connected in parallel. When selecting the capacitor ensure that the capacitance of more than 1µF(3.0V ≤ Vo ≤ 15.0V) or more than 4.7µF(1.0V ≤ Vo < 3.0V) is maintained at the intended applied voltage and temperature range. Due to changes in temperature, the capacitance can fluctuate possibly resulting in oscillation. For selection of the capacitor refer to the Cout\_ESR vs Io data. The stable operation range given in the reference data is based on the standalone IC and resistive load. For actual applications the stable operating range is influenced by the PCB impedance, input supply impedance and load impedance. Therefore verification of the final operating environment is needed.

When selecting a ceramic type capacitor, we recommend using X5R, X7R or better with excellent temperature and DC-biasing characteristics and high voltage tolerance.

Also, in case of rapidly changing input voltage and load current, select the capacitance in accordance with verifying that the actual application meets with the required specification.

$4.0V \leq V_{CC} \leq 26.5V$

$3.0V \leq V_o \leq 15.0V$

$-40^{\circ}C \leq T_a \leq +125^{\circ}C$

$5k\Omega \leq R_1 \leq 10k\Omega$  (BD00C0AW)

$C_{in} = 2.2\mu F \leq C_{in} \leq 100\mu F$

$1\mu F \leq C_{out} \leq 100\mu F$

$4.0V \leq V_{CC} \leq 26.5V$

$3.0V \leq V_o \leq 15.0V$

$-40^{\circ}C \leq T_a \leq +125^{\circ}C$

$0A \leq I_o \leq 1A$

$5k\Omega \leq R_1 \leq 10k\Omega$  (BD00C0AW)

$6.0V \leq V_{CC} \leq 26.5V$

$5.0V \leq V_o \leq 15.0V$

$-40^{\circ}C \leq T_a \leq +125^{\circ}C$

$0A \leq I_o \leq 1A$

$5k\Omega \leq R_1 \leq 10k\Omega$  (BD00C0AW)

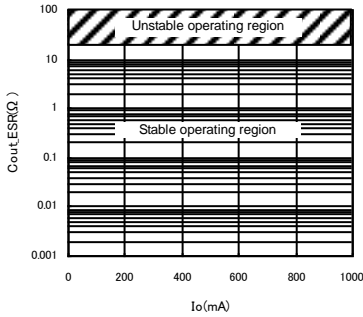

Cout\_ESR vs Io  
3.0V ≤ Vo ≤ 15.0V  
(Reference data)

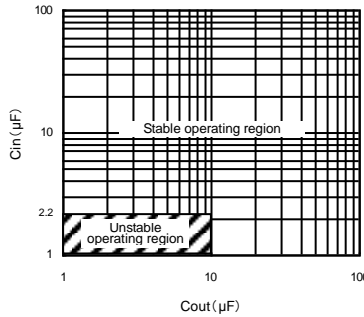

Cin vs Cout  
3.0V ≤ Vo ≤ 15.0V  
(Reference data)

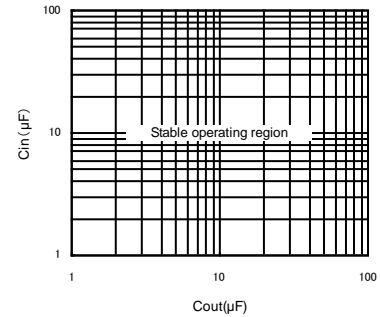

$4.0V \leq V_{CC} \leq 26.5V$

$1.0V \leq V_o < 3.0V$

$-40^{\circ}C \leq T_a \leq +125^{\circ}C$

$5k\Omega \leq R_1 \leq 10k\Omega$  (BD00C0AW)

$2.2\mu F \leq C_{in} \leq 100\mu F$

$4.7\mu F \leq C_{out} \leq 100\mu F$

$4.0V \leq V_{CC} \leq 26.5V$

$1.5V \leq V_o < 3.0V$

$-40^{\circ}C \leq T_a \leq +125^{\circ}C$

$5k\Omega \leq R_1 \leq 10k\Omega$  (BD00C0AW)

$2.2\mu F \leq C_{in} \leq 100\mu F$

$4.7\mu F \leq C_{out} \leq 100\mu F$

$4.0V \leq V_{CC} \leq 26.5V$

$1.0V \leq V_o < 3.0V$

$-40^{\circ}C \leq T_a \leq +125^{\circ}C$

$0A \leq I_o \leq 1A$

$5k\Omega \leq R_1 \leq 10k\Omega$  (BD00C0AW)

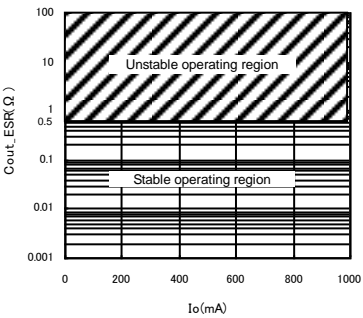

Cout\_ESR vs Io  
1.0V ≤ Vo < 3.0V  
(Reference data)

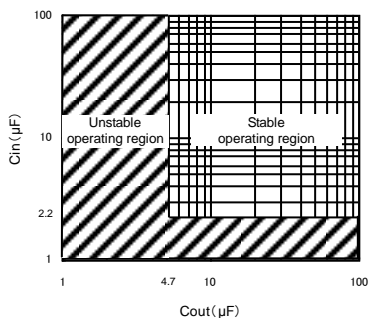
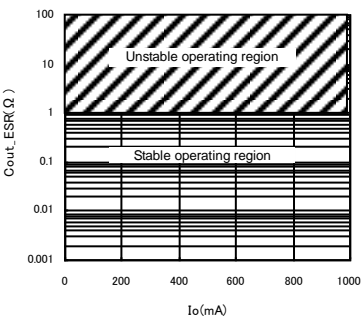

Cin vs Cout  
1.0V ≤ Vo < 3.0V  
(Reference data)

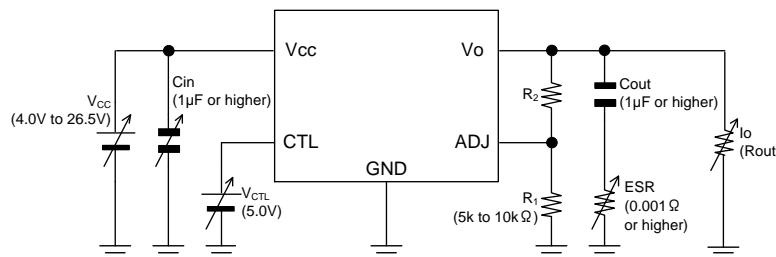

Operation Note 15 Measurement circuit (BD00C0AW)

Operational Notes – continued

4.0V ≤ Vcc ≤ 26.5V  
 1.0V ≤ Vo < 3.0V  
 (Cout and Ceramic capacitor 10μF is connected in parallel.)  
 -40°C ≤ Ta ≤ +125°C  
 5kΩ ≤ R1 ≤ 10kΩ (BD00C0AW)  
 2.2μF ≤ Cin ≤ 100μF  
 1μF ≤ Cout ≤ 100μF

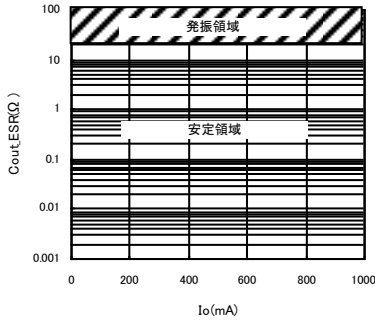

Cout\_ESR vs Io  
 1.0V ≤ Vo < 3.0V  
 Cout and Ceramic capacitor 10μF is connected in parallel.  
 (Reference data)

4.0V ≤ Vcc ≤ 26.5V  
 1.0V ≤ Vo < 3.0V  
 (Cout and Ceramic capacitor 10μF is connected in parallel.)  
 -40°C ≤ Ta ≤ +125°C  
 0A ≤ Io ≤ 1A  
 5kΩ ≤ R1 ≤ 10kΩ (BD00C0AW)

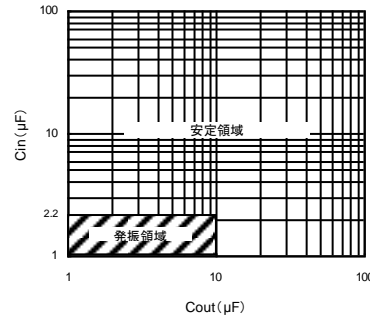

Cin vs Cout  
 1.0V ≤ Vo < 3.0V  
 Cout and Ceramic capacitor 10μF is connected in parallel.  
 (Reference data)

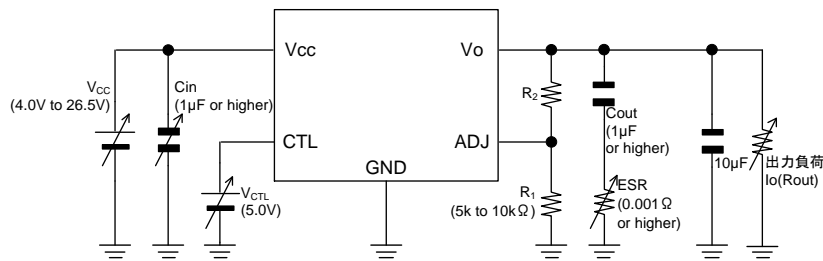

Operation Note 15 Measurement circuit (BD00C0AW)

16. CTL Pin

Do not set the voltage level on the IC's enable pin in between VthH and VthL. Do not leave it floating or unconnected, otherwise, the output voltage would be unstable.

17. Rapid variation in Vcc Voltage and load Current CTL Pin

In case of a rapidly changing input voltage, transients in the output voltage might occur due to the use of a MOSFET as output transistor. Although the actual application might be the cause of the transients, the IC input voltage, output current and temperature are also possible causes. In case problems arise within the actual operating range, use countermeasures such as adjusting the output capacitance.

18. Minute variation in output voltage

In case of using an application susceptible to minute changes to the output voltage due to noise, changes in input and load current, etc., use countermeasures such as implementing filters.

19. In some applications, the Vcc and pin potential might be reversed, possibly resulting in circuit internal damage or damage to the elements. For example, while the external capacitor is charged, the Vcc shorts to the GND. Use a capacitor with a capacitance with less than 1000μF. We also recommend using reverse polarity diodes in series or a bypass between all pins and the Vcc pin.

Physical Dimension, Tape and Reel Information

Package Name	TO252-3
--------------	---------

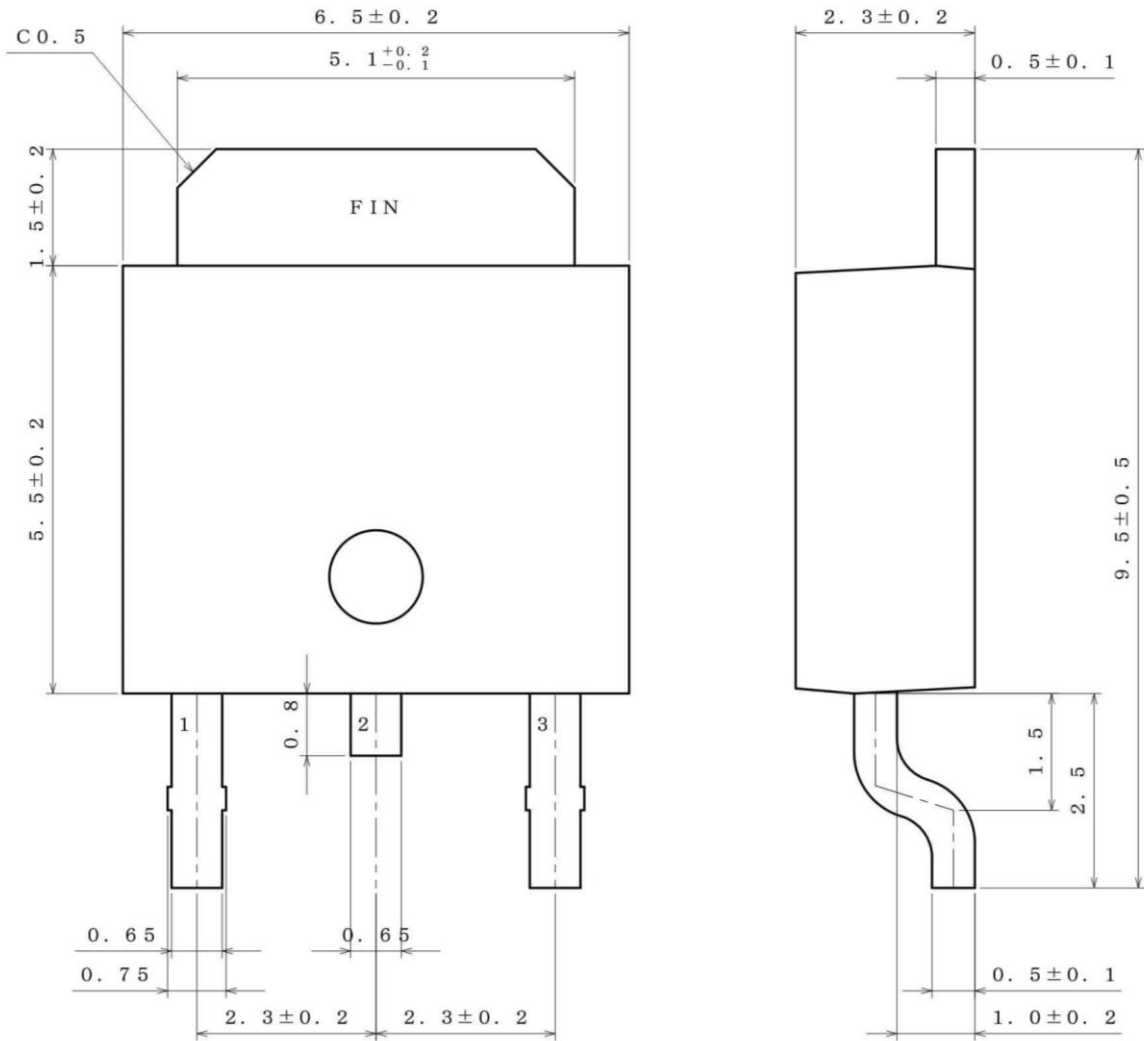

(UNITS ; mm)  
 PKG : TO252-3  
 Drawing No. EX535-5001-1

< Tape and Reel Information >

Tape	Embossed carrier tape
Quantity	2000pcs
Direction of feed	E2 The direction is the 1 pin of product is at the lower left when you hold reel on the left hand and you pull out the tape on the right hand

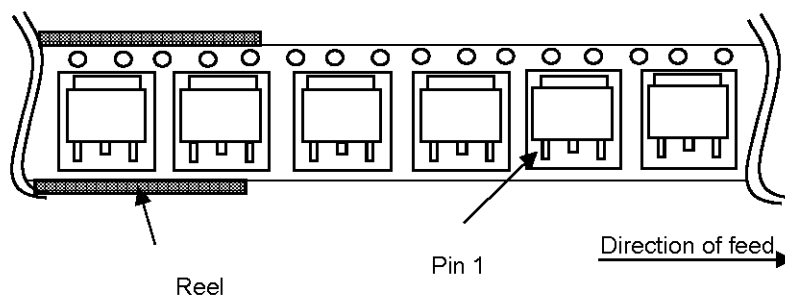

Physical Dimension, Tape and Reel Information

Package Name	TO252-5
--------------	---------

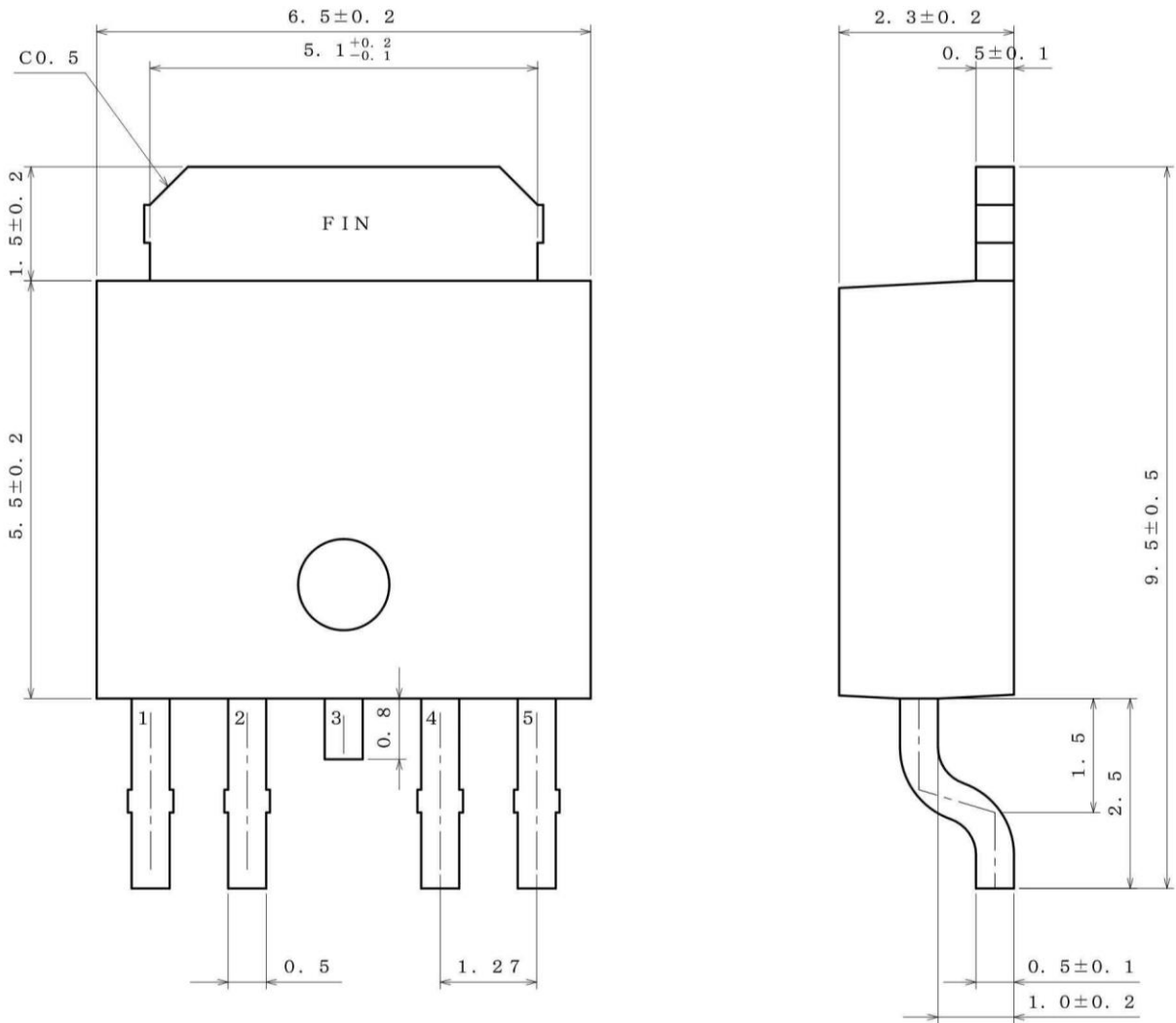

(UNIT : mm)  
 PKG : TO252-5  
 Drawing No. EX536-5001-1

< Tape and Reel Information >

Tape	Embossed carrier tape
Quantity	2000pcs
Direction of feed	E2 The direction is the 1pin of product is at the lower left when you hold reel on the left hand and you pull out the tape on the right hand

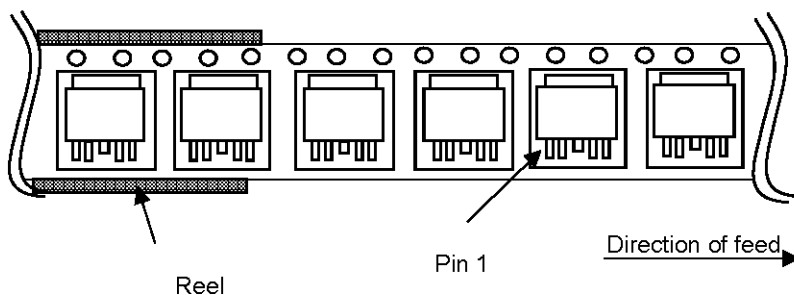

Physical Dimension, Tape and Reel Information

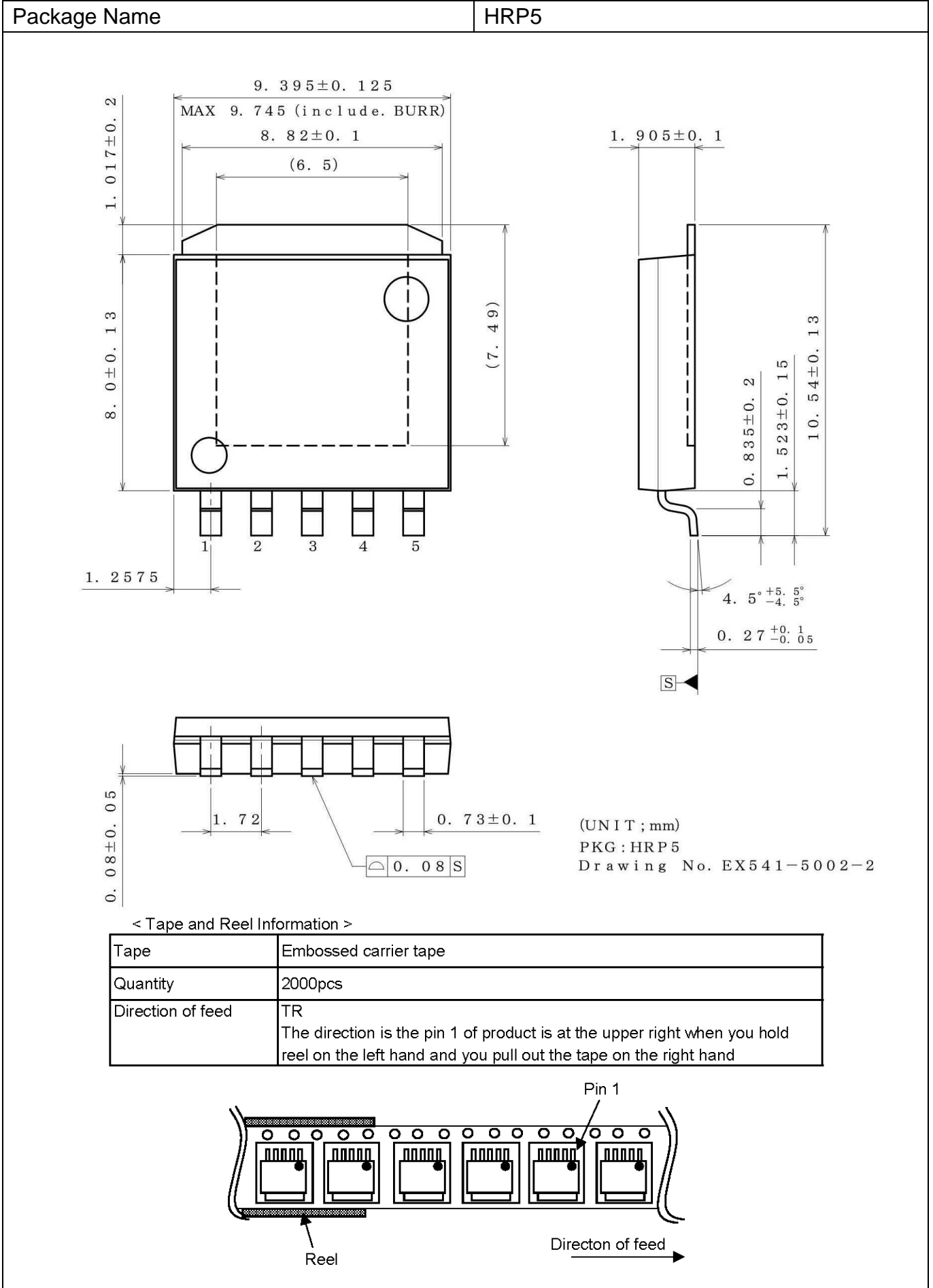

Physical Dimension, Tape and Reel Information

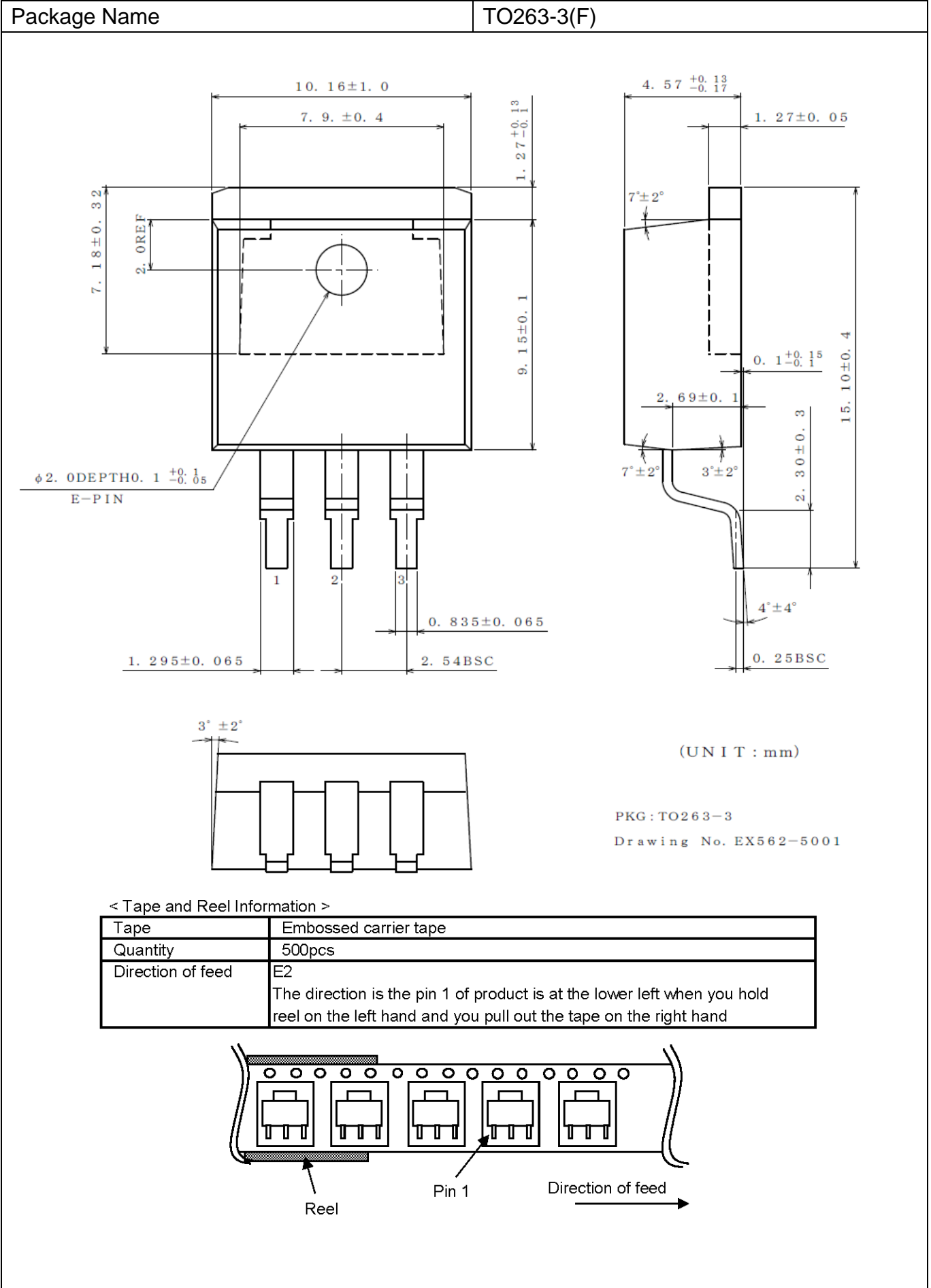

Physical Dimension, Tape and Reel Information

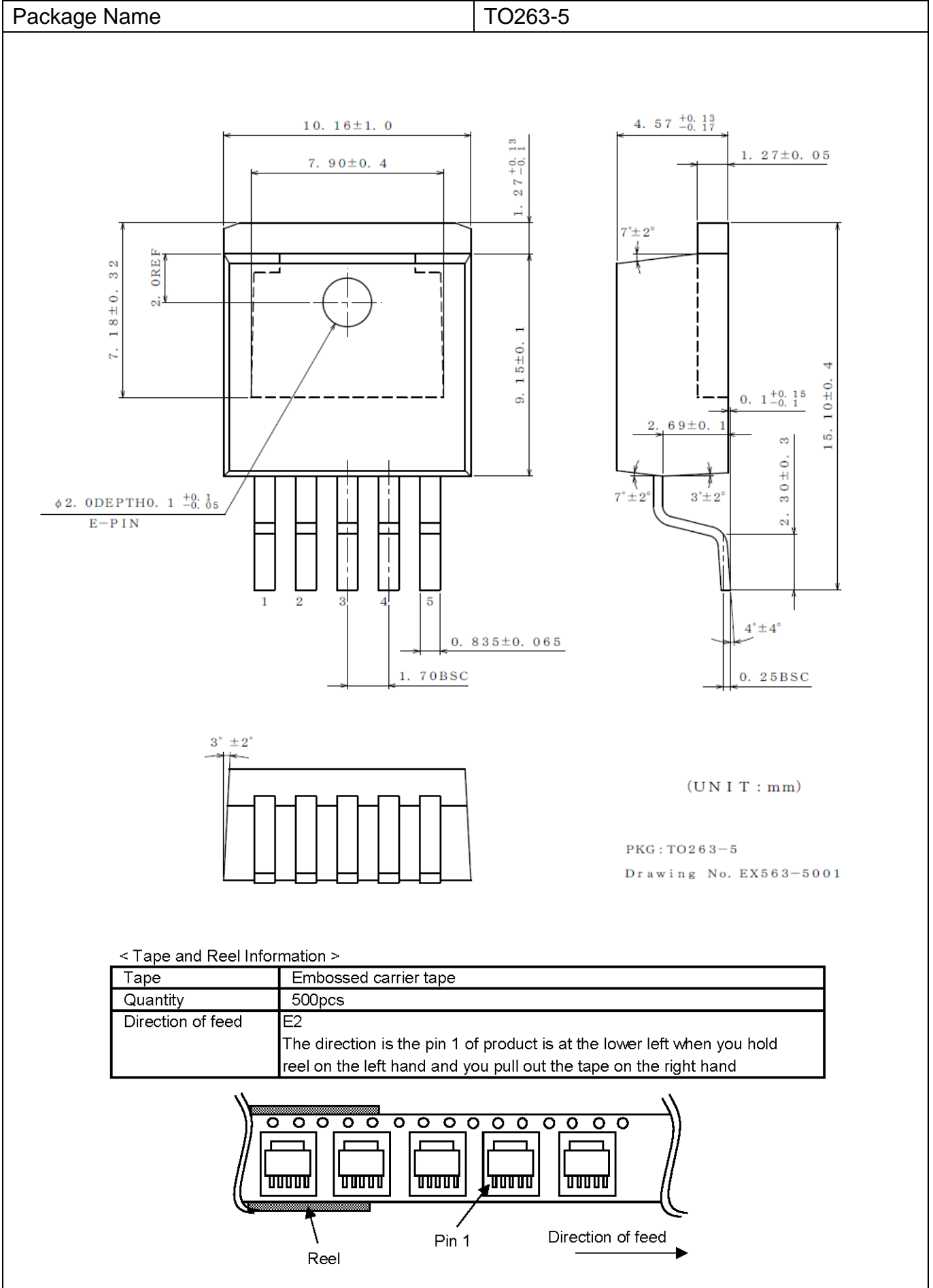

Marking Diagrams (TOP VIEW)

TO252-3

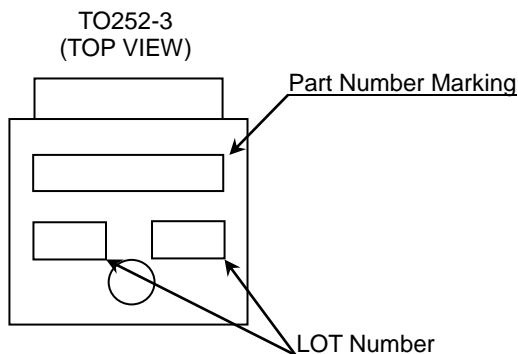

Output Voltage(V)	Part Number Marking
3.3	33C0AC
5.0	50C0AC
8.0	80C0AC
9.0	90C0AC

TO252-5

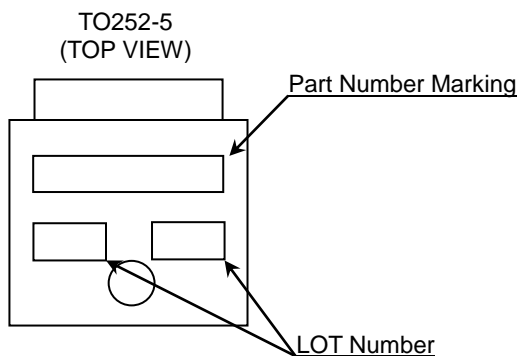

Output Voltage(V)	Part Number Marking
Variable	00C0AWC
3.3	33C0AWC
5.0	50C0AWC
8.0	80C0AWC
9.0	90C0AWC

HRP5

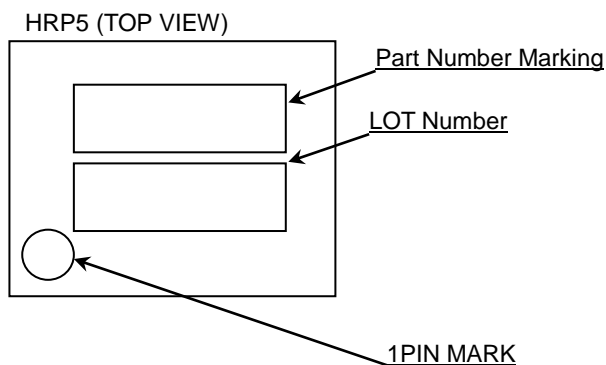

Output Voltage(V)	Output Control Pin	Part Number Marking
Variable	With SW	00C0AWHFPC
3.3	With SW	33C0AWHFPC
	Without SW	33C0AHFPC
5.0	With SW	50C0AWHFPC
	Without SW	50C0AHFPC
8.0	With SW	80C0AWHFPC
	Without SW	80C0AHFPC
9.0	With SW	90C0AWHFPC
	Without SW	90C0AHFPC

TO263-3(F)

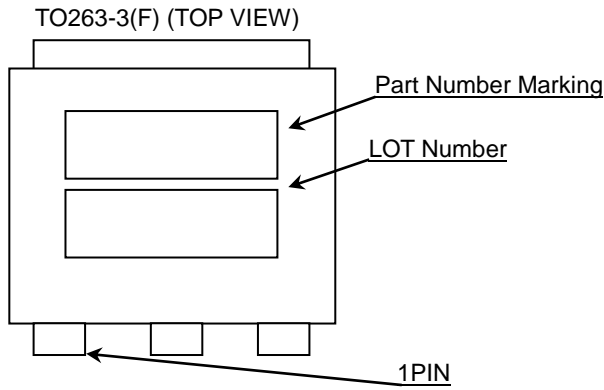

Output Voltage(V)	Part Number Marking
3.3	33C0AC
5.0	50C0AC
8.0	80C0AC
9.0	90C0AC

TO263-5

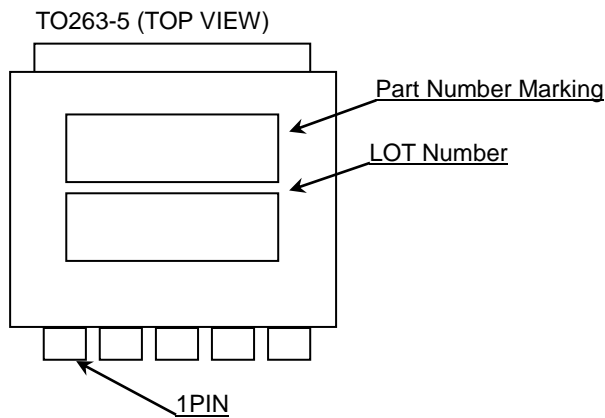

Output Voltage(V)	Part Number Marking
Variable	00C0AWC
3.3	33C0AWC
5.0	50C0AWC
8.0	80C0AWC
9.0	90C0AWC

## Revision History

Date	Revision	Changes
16.Nov.2012	001	New Release
07.Mar.2013	002	The condition of output pin is changed on Operational Note 11. The mention of "Status of this document" is removed.
2.Sep.2013	003	<ul style="list-style-type: none"> <li>▪ Error in writing were corrected</li> <li>▪ New release TO263-3F, TO263-5F, packages.</li> <li>▪ Thermal Resistance and Power Dissipation are changed to be compliant with JEDEC standard.</li> <li>▪ All characters were conformed to the Chicago manual.</li> <li>▪ The sign in the annotation part was changed from "※n" into "(Note n)."</li> <li>▪ NOTE under the absolute maximum rating of P.2 was deleted because it had overlapped with P.1.</li> <li>▪ Sentences of "Power consumption Pc of IC when short-circuited" that exists in P.30 are deleted.</li> <li>▪ "Operational Notes" were updated.</li> </ul>
11.Oct.2013	004	<ul style="list-style-type: none"> <li>▪ Page. 31 Error in writing were corrected</li> </ul>
27.Jan.2017	005	<ul style="list-style-type: none"> <li>▪ TO263-3 and TO263-5 were added.</li> <li>▪ The description method of thermal Resistance was changed to unify.</li> <li>▪ AEC-Q100 (Note1:Grade1) was appended.</li> <li>▪ Drop voltage figure was corrected. (P.12, 25)</li> <li>▪ Figure 78 I/O equivalent was corrected. (P.31)</li> <li>▪ Error in direction of feed was corrected. (P.39, 40)</li> </ul>

# Notice

## Precaution on using ROHM Products

1. If you intend to use our Products in devices requiring extremely high reliability (such as medical equipment <sup>(Note 1)</sup>, aircraft/spacecraft, nuclear power controllers, etc.) and whose malfunction or failure may cause loss of human life, bodily injury or serious damage to property ("Specific Applications"), please consult with the ROHM sales representative in advance. Unless otherwise agreed in writing by ROHM in advance, ROHM shall not be in any way responsible or liable for any damages, expenses or losses incurred by you or third parties arising from the use of any ROHM's Products for Specific Applications.

(Note1) Medical Equipment Classification of the Specific Applications

JAPAN	USA	EU	CHINA
CLASS III	CLASS III	CLASS II b	CLASS III
CLASS IV		CLASS III	

2. ROHM designs and manufactures its Products subject to strict quality control system. However, semiconductor products can fail or malfunction at a certain rate. Please be sure to implement, at your own responsibilities, adequate safety measures including but not limited to fail-safe design against the physical injury, damage to any property, which a failure or malfunction of our Products may cause. The following are examples of safety measures:
  - [a] Installation of protection circuits or other protective devices to improve system safety
  - [b] Installation of redundant circuits to reduce the impact of single or multiple circuit failure
3. Our Products are not designed under any special or extraordinary environments or conditions, as exemplified below. Accordingly, ROHM shall not be in any way responsible or liable for any damages, expenses or losses arising from the use of any ROHM's Products under any special or extraordinary environments or conditions. If you intend to use our Products under any special or extraordinary environments or conditions (as exemplified below), your independent verification and confirmation of product performance, reliability, etc. prior to use, must be necessary:
  - [a] Use of our Products in any types of liquid, including water, oils, chemicals, and organic solvents
  - [b] Use of our Products outdoors or in places where the Products are exposed to direct sunlight or dust
  - [c] Use of our Products in places where the Products are exposed to sea wind or corrosive gases, including Cl<sub>2</sub>, H<sub>2</sub>S, NH<sub>3</sub>, SO<sub>2</sub>, and NO<sub>2</sub>
  - [d] Use of our Products in places where the Products are exposed to static electricity or electromagnetic waves
  - [e] Use of our Products in proximity to heat-producing components, plastic cords, or other flammable items
  - [f] Sealing or coating our Products with resin or other coating materials
  - [g] Use of our Products without cleaning residue of flux (even if you use no-clean type fluxes, cleaning residue of flux is recommended); or Washing our Products by using water or water-soluble cleaning agents for cleaning residue after soldering
  - [h] Use of the Products in places subject to dew condensation
4. The Products are not subject to radiation-proof design.
5. Please verify and confirm characteristics of the final or mounted products in using the Products.
6. In particular, if a transient load (a large amount of load applied in a short period of time, such as pulse. is applied, confirmation of performance characteristics after on-board mounting is strongly recommended. Avoid applying power exceeding normal rated power; exceeding the power rating under steady-state loading condition may negatively affect product performance and reliability.
7. De-rate Power Dissipation depending on ambient temperature. When used in sealed area, confirm that it is the use in the range that does not exceed the maximum junction temperature.
8. Confirm that operation temperature is within the specified range described in the product specification.
9. ROHM shall not be in any way responsible or liable for failure induced under deviant condition from what is defined in this document.

## Precaution for Mounting / Circuit board design

1. When a highly active halogenous (chlorine, bromine, etc.) flux is used, the residue of flux may negatively affect product performance and reliability.
2. In principle, the reflow soldering method must be used on a surface-mount products, the flow soldering method must be used on a through hole mount products. If the flow soldering method is preferred on a surface-mount products, please consult with the ROHM representative in advance.

For details, please refer to ROHM Mounting specification

### Precautions Regarding Application Examples and External Circuits

1. If change is made to the constant of an external circuit, please allow a sufficient margin considering variations of the characteristics of the Products and external components, including transient characteristics, as well as static characteristics.
2. You agree that application notes, reference designs, and associated data and information contained in this document are presented only as guidance for Products use. Therefore, in case you use such information, you are solely responsible for it and you must exercise your own independent verification and judgment in the use of such information contained in this document. ROHM shall not be in any way responsible or liable for any damages, expenses or losses incurred by you or third parties arising from the use of such information.

### Precaution for Electrostatic

This Product is electrostatic sensitive product, which may be damaged due to electrostatic discharge. Please take proper caution in your manufacturing process and storage so that voltage exceeding the Products maximum rating will not be applied to Products. Please take special care under dry condition (e.g. Grounding of human body / equipment / solder iron, isolation from charged objects, setting of Ionizer, friction prevention and temperature / humidity control).

### Precaution for Storage / Transportation

1. Product performance and soldered connections may deteriorate if the Products are stored in the places where:
  - [a] the Products are exposed to sea winds or corrosive gases, including Cl<sub>2</sub>, H<sub>2</sub>S, NH<sub>3</sub>, SO<sub>2</sub>, and NO<sub>2</sub>
  - [b] the temperature or humidity exceeds those recommended by ROHM
  - [c] the Products are exposed to direct sunshine or condensation
  - [d] the Products are exposed to high Electrostatic
2. Even under ROHM recommended storage condition, solderability of products out of recommended storage time period may be degraded. It is strongly recommended to confirm solderability before using Products of which storage time is exceeding the recommended storage time period.
3. Store / transport cartons in the correct direction, which is indicated on a carton with a symbol. Otherwise bent leads may occur due to excessive stress applied when dropping of a carton.
4. Use Products within the specified time after opening a humidity barrier bag. Baking is required before using Products of which storage time is exceeding the recommended storage time period.

### Precaution for Product Label

A two-dimensional barcode printed on ROHM Products label is for ROHM's internal use only.

### Precaution for Disposition

When disposing Products please dispose them properly using an authorized industry waste company.

### Precaution for Foreign Exchange and Foreign Trade act

Since concerned goods might be fallen under listed items of export control prescribed by Foreign exchange and Foreign trade act, please consult with ROHM in case of export.

### Precaution Regarding Intellectual Property Rights

1. All information and data including but not limited to application example contained in this document is for reference only. ROHM does not warrant that foregoing information or data will not infringe any intellectual property rights or any other rights of any third party regarding such information or data.
2. ROHM shall not have any obligations where the claims, actions or demands arising from the combination of the Products with other articles such as components, circuits, systems or external equipment (including software).
3. No license, expressly or implied, is granted hereby under any intellectual property rights or other rights of ROHM or any third parties with respect to the Products or the information contained in this document. Provided, however, that ROHM will not assert its intellectual property rights or other rights against you or your customers to the extent necessary to manufacture or sell products containing the Products, subject to the terms and conditions herein.

### Other Precaution

1. This document may not be reprinted or reproduced, in whole or in part, without prior written consent of ROHM.
2. The Products may not be disassembled, converted, modified, reproduced or otherwise changed without prior written consent of ROHM.
3. In no event shall you use in any way whatsoever the Products and the related technical information contained in the Products or this document for any military purposes, including but not limited to, the development of mass-destruction weapons.
4. The proper names of companies or products described in this document are trademarks or registered trademarks of ROHM, its affiliated companies or third parties.

**General Precaution**

1. Before you use our Products, you are requested to carefully read this document and fully understand its contents. ROHM shall not be in any way responsible or liable for failure, malfunction or accident arising from the use of any ROHM's Products against warning, caution or note contained in this document.
2. All information contained in this document is current as of the issuing date and subject to change without any prior notice. Before purchasing or using ROHM's Products, please confirm the latest information with a ROHM sales representative.
3. The information contained in this document is provided on an "as is" basis and ROHM does not warrant that all information contained in this document is accurate and/or error-free. ROHM shall not be in any way responsible or liable for any damages, expenses or losses incurred by you or third parties resulting from inaccuracy or errors of or concerning such information.

## Looking for pricing, stock, or lifecycle information?

Click below to explore more details on WIN SOURCE:

- ⊖ [View BD00C0AWHFP-CTR on WIN SOURCE](#)
- ⊖ [Rohm Semiconductor](#) Information

## Optimize Your Supply Chain with WIN SOURCE Solutions

- ✓ Global Sourcing Solution
- ✓ Obsolete Management
- ✓ Cost Control Management
- ✓ Shortage Management
- ✓ Alternative Solution
- ✓ Excess Inventory Management