



**THE DATASHEET OF
BSC160N15NS5ATMA1**



MOSFET

OptiMOS™ 5 Power-Transistor, 150 V

Features

- N-channel, normal level
- Excellent gate charge x $R_{DS(on)}$ product (FOM)
- Very low on-resistance $R_{DS(on)}$
- Very low reverse recovery charge (Qrr)
- 150 °C operating temperature
- Pb-free lead plating; RoHS compliant
- Qualified according to JEDEC¹⁾ for target application
- Ideal for high-frequency switching and synchronous rectification

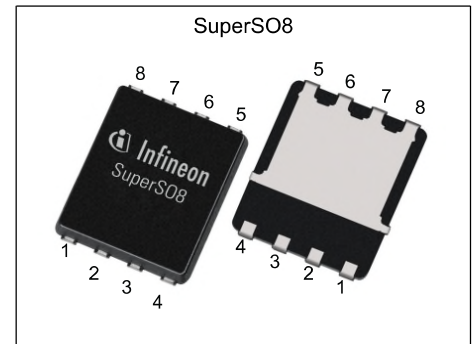
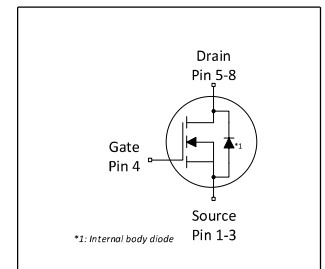

Table 1 Key Performance Parameters

Parameter	Value	Unit
V_{DS}	150	V
$R_{DS(on),max}$	16	m Ω
I_D	56	A
Q_{rr}	25.7	nC



RoHS

Type / Ordering Code	Package	Marking	Related Links
BSC160N15NS5	PG-TDSON-8	160N15NS	-

¹⁾ J-STD20 and JESD22

Table of Contents

Description	1
Maximum ratings	3
Thermal characteristics	3
Electrical characteristics	3
Electrical characteristics diagrams	5
Package Outlines	9
Revision History	12
Trademarks	12
Disclaimer	12

1 Maximum ratings

at $T_A=25\text{ °C}$, unless otherwise specified

Table 2 Maximum ratings

Parameter	Symbol	Values			Unit	Note / Test Condition
		Min.	Typ.	Max.		
Continuous drain current	I_D	-	-	56	A	$T_C=25\text{ °C}$ $T_C=100\text{ °C}$
Pulsed drain current ¹⁾	$I_{D,pulse}$	-	-	224	A	$T_C=25\text{ °C}$
Avalanche energy, single pulse ²⁾	E_{AS}	-	-	43	mJ	$I_D=50\text{ A}$, $R_{GS}=25\text{ }\Omega$
Gate source voltage	V_{GS}	-20	-	20	V	-
Power dissipation	P_{tot}	-	-	96	W	$T_C=25\text{ °C}$
Operating and storage temperature	T_j , T_{stg}	-55	-	150	°C	IEC climatic category; DIN IEC 68-1: 55/150/56

2 Thermal characteristics

Table 3 Thermal characteristics

Parameter	Symbol	Values			Unit	Note / Test Condition
		Min.	Typ.	Max.		
Thermal resistance, junction - case	R_{thJC}	-	0.78	1.3	K/W	-
Thermal resistance, junction - ambient (6 cm ² cooling area ³⁾)	R_{thJA}	-	-	50	K/W	-

3 Electrical characteristics

at $T_j=25\text{ °C}$, unless otherwise specified

Table 4 Static characteristics

Parameter	Symbol	Values			Unit	Note / Test Condition
		Min.	Typ.	Max.		
Drain-source breakdown voltage	$V_{(BR)DSS}$	150	-	-	V	$V_{GS}=0\text{ V}$, $I_D=1\text{ mA}$
Gate threshold voltage	$V_{GS(th)}$	3.0	3.8	4.6	V	$V_{DS}=V_{GS}$, $I_D=60\text{ }\mu\text{A}$
Zero gate voltage drain current	I_{DSS}	-	0.1	1	μA	$V_{DS}=120\text{ V}$, $V_{GS}=0\text{ V}$, $T_j=25\text{ °C}$ $V_{DS}=120\text{ V}$, $V_{GS}=0\text{ V}$, $T_j=125\text{ °C}$
Gate-source leakage current	I_{GSS}	-	1	100	nA	$V_{GS}=20\text{ V}$, $V_{DS}=0\text{ V}$
Drain-source on-state resistance	$R_{DS(on)}$	-	13.7	16	m Ω	$V_{GS}=10\text{ V}$, $I_D=28\text{ A}$, $V_{GS}=8\text{ V}$, $I_D=14\text{ A}$
Gate resistance ⁴⁾	R_G	-	1	1.5	Ω	-
Transconductance	g_{fs}	20	40	-	S	$ V_{DS} >2 I_D R_{DS(on)max}$, $I_D=28\text{ A}$

¹⁾ See Diagram 3 for more detailed information

²⁾ See Diagram 13 for more detailed information

³⁾ Device on 40 mm x 40 mm x 1.5 mm epoxy PCB FR4 with 6 cm² (one layer, 70 μm thick) copper area for drain connection. PCB is vertical in still air.

⁴⁾ Defined by design. Not subject to production test

Table 5 Dynamic characteristics

Parameter	Symbol	Values			Unit	Note / Test Condition
		Min.	Typ.	Max.		
Input capacitance ¹⁾	C_{iss}	-	1370	1820	pF	$V_{GS}=0\text{ V}$, $V_{DS}=75\text{ V}$, $f=1\text{ MHz}$
Output capacitance ¹⁾	C_{oss}	-	341	454	pF	$V_{GS}=0\text{ V}$, $V_{DS}=75\text{ V}$, $f=1\text{ MHz}$
Reverse transfer capacitance ¹⁾	C_{riss}	-	9.6	17	pF	$V_{GS}=0\text{ V}$, $V_{DS}=75\text{ V}$, $f=1\text{ MHz}$
Turn-on delay time	$t_{d(on)}$	-	9.6	-	ns	$V_{DD}=75\text{ V}$, $V_{GS}=10\text{ V}$, $I_D=28\text{ A}$, $R_{G,ext}=3\ \Omega$
Rise time	t_r	-	3	-	ns	$V_{DD}=75\text{ V}$, $V_{GS}=10\text{ V}$, $I_D=28\text{ A}$, $R_{G,ext}=3\ \Omega$
Turn-off delay time	$t_{d(off)}$	-	10.8	-	ns	$V_{DD}=75\text{ V}$, $V_{GS}=10\text{ V}$, $I_D=28\text{ A}$, $R_{G,ext}=3\ \Omega$
Fall time	t_f	-	2.6	-	ns	$V_{DD}=75\text{ V}$, $V_{GS}=10\text{ V}$, $I_D=28\text{ A}$, $R_{G,ext}=3\ \Omega$

Table 6 Gate charge characteristics²⁾

Parameter	Symbol	Values			Unit	Note / Test Condition
		Min.	Typ.	Max.		
Gate to source charge	Q_{GS}	-	8	-	nC	$V_{DD}=75\text{ V}$, $I_D=28\text{ A}$, $V_{GS}=0\text{ to }10\text{ V}$
Gate to drain charge ¹⁾	Q_{GD}	-	4	5.9	nC	$V_{DD}=75\text{ V}$, $I_D=28\text{ A}$, $V_{GS}=0\text{ to }10\text{ V}$
Switching charge	Q_{SW}	-	7.8	-	nC	$V_{DD}=75\text{ V}$, $I_D=28\text{ A}$, $V_{GS}=0\text{ to }10\text{ V}$
Gate charge total ¹⁾	Q_g	-	19	23.1	nC	$V_{DD}=75\text{ V}$, $I_D=28\text{ A}$, $V_{GS}=0\text{ to }10\text{ V}$
Gate plateau voltage	$V_{plateau}$	-	5.8	-	V	$V_{DD}=75\text{ V}$, $I_D=28\text{ A}$, $V_{GS}=0\text{ to }10\text{ V}$
Output charge ¹⁾	Q_{oss}	-	51	68.2	nC	$V_{DD}=75\text{ V}$, $V_{GS}=0\text{ V}$

Table 7 Reverse diode

Parameter	Symbol	Values			Unit	Note / Test Condition
		Min.	Typ.	Max.		
Diode continuous forward current	I_S	-	-	66	A	$T_C=25\text{ °C}$
Diode pulse current	$I_{S,pulse}$	-	-	224	A	$T_C=25\text{ °C}$
Diode forward voltage	V_{SD}	-	0.88	1.2	V	$V_{GS}=0\text{ V}$, $I_F=28\text{ A}$, $T_J=25\text{ °C}$
Reverse recovery time ¹⁾	t_{rr}	-	30.5	61	ns	$V_R=75\text{ V}$, $I_F=28$, $di_F/dt=100\text{ A}/\mu\text{s}$
Reverse recovery charge ¹⁾	Q_{rr}	-	25.7	51.4	nC	$V_R=75\text{ V}$, $I_F=28$, $di_F/dt=100\text{ A}/\mu\text{s}$

¹⁾ Defined by design. Not subject to production test

²⁾ See "Gate charge waveforms" for parameter definition

4 Electrical characteristics diagrams

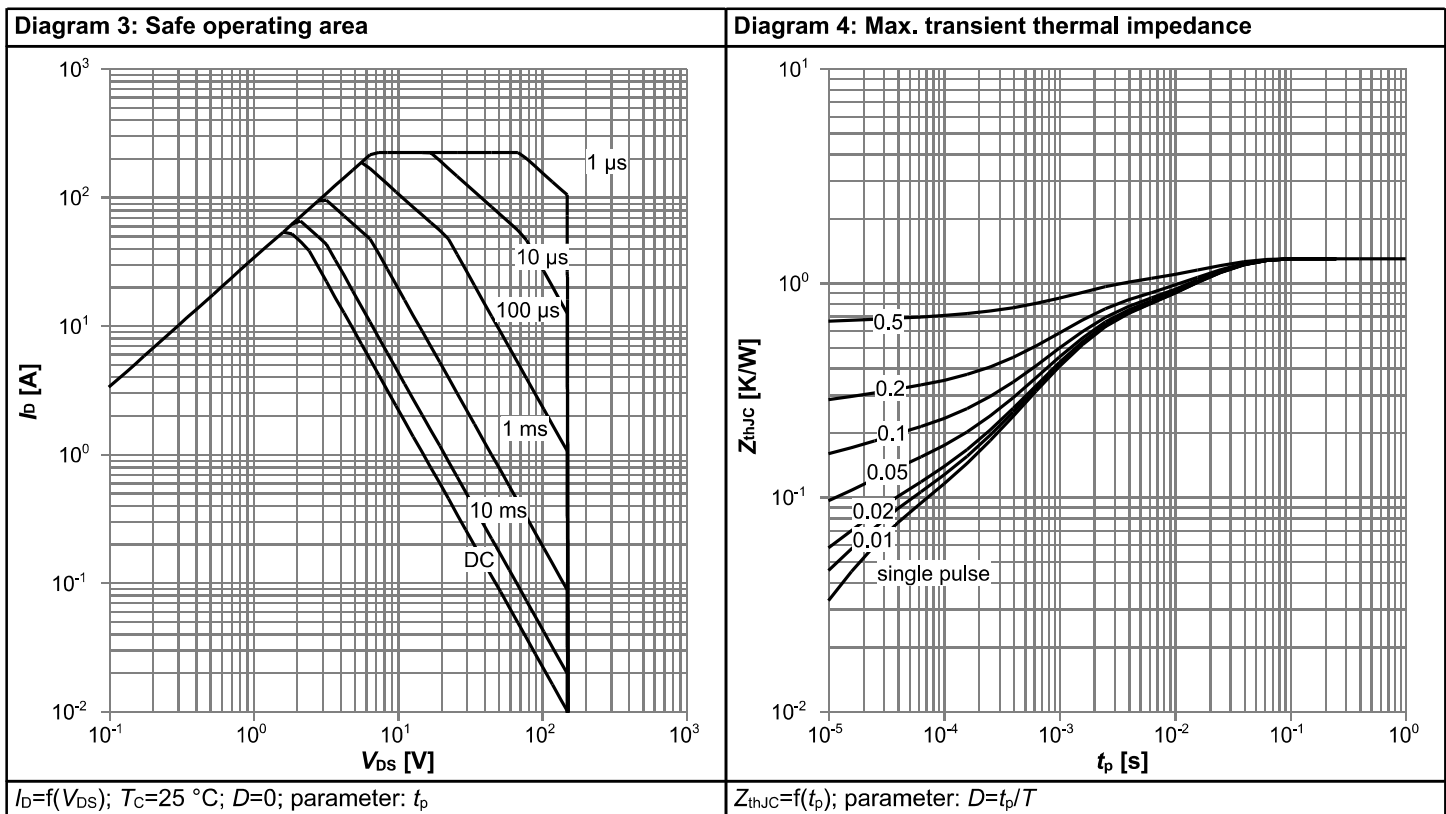
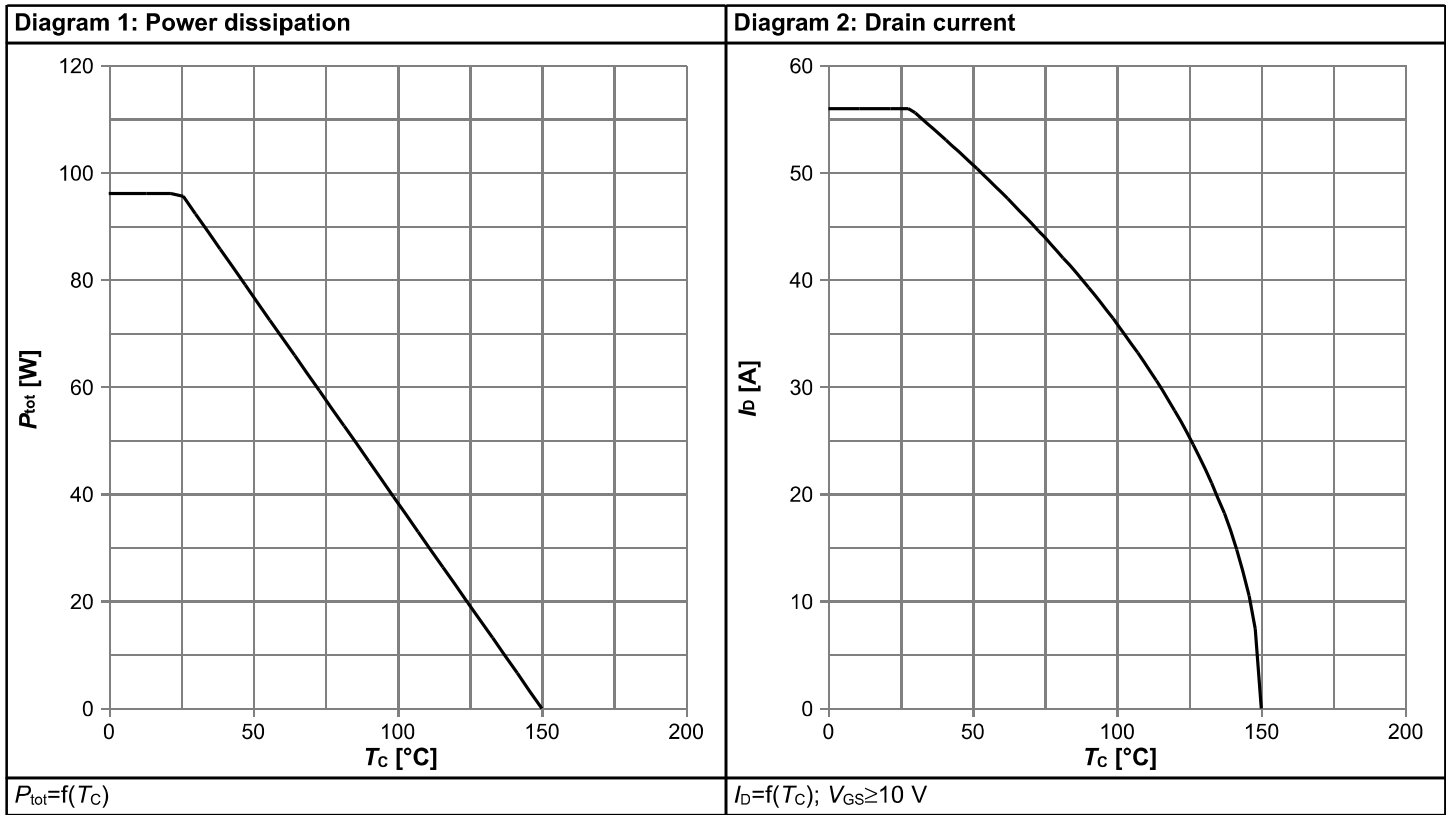
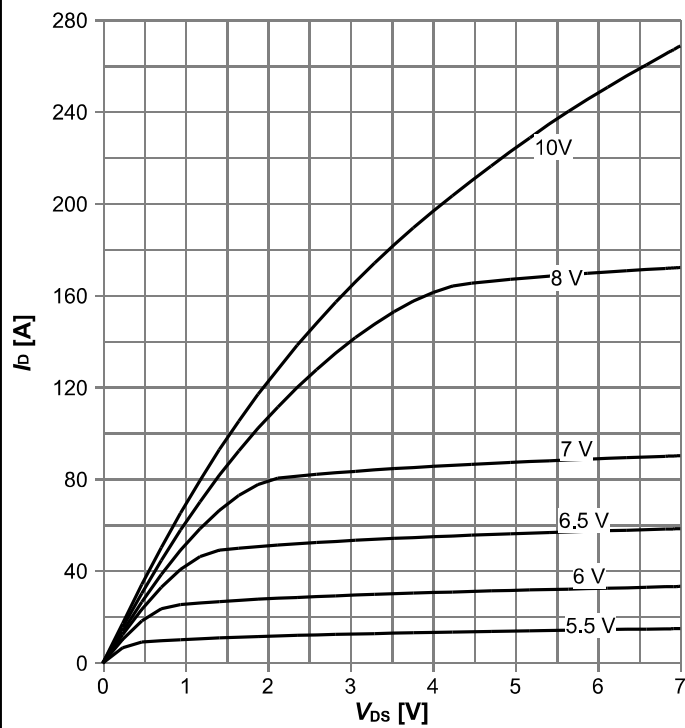
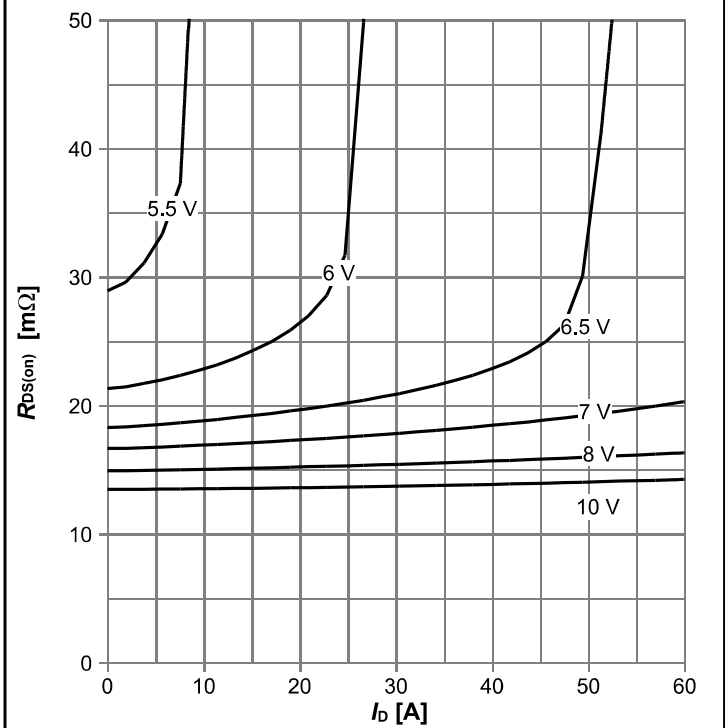

Diagram 5: Typ. output characteristics



$I_D = f(V_{DS}); T_J = 25\text{ °C};$ parameter: V_{GS}

Diagram 6: Typ. drain-source on resistance



$R_{DS(on)} = f(I_D); T_J = 25\text{ °C};$ parameter: V_{GS}

Diagram 7: Typ. transfer characteristics

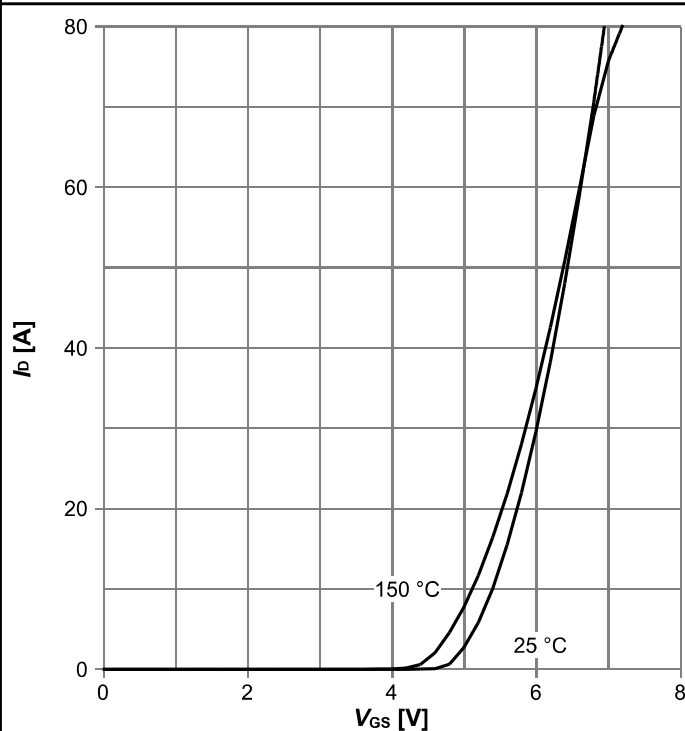

$I_D = f(V_{GS}); |V_{DS}| > 2|I_D|R_{DS(on)max};$ parameter: T_J

Diagram 8: Typ. forward transconductance

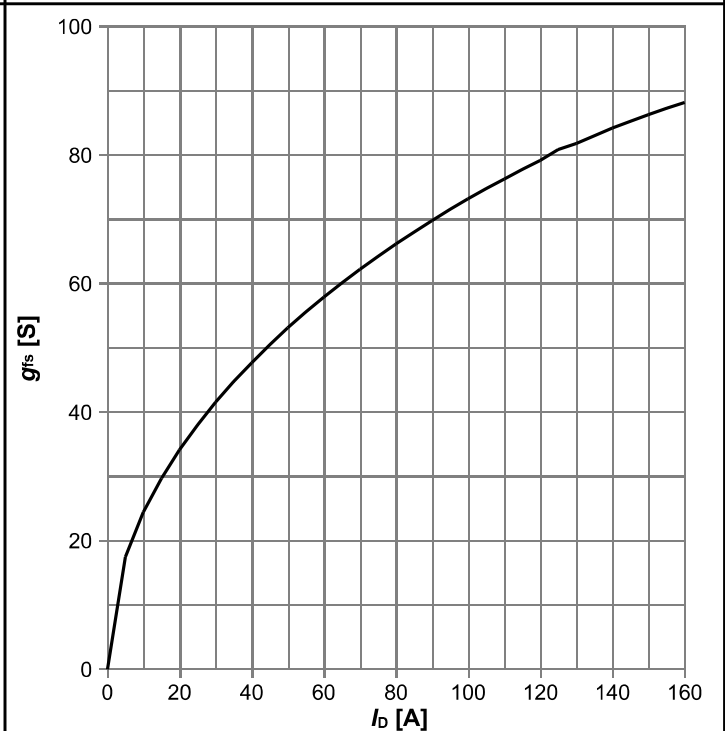

$g_{fs} = f(I_D); T_J = 25\text{ °C}$

Diagram 9: Drain-source on-state resistance

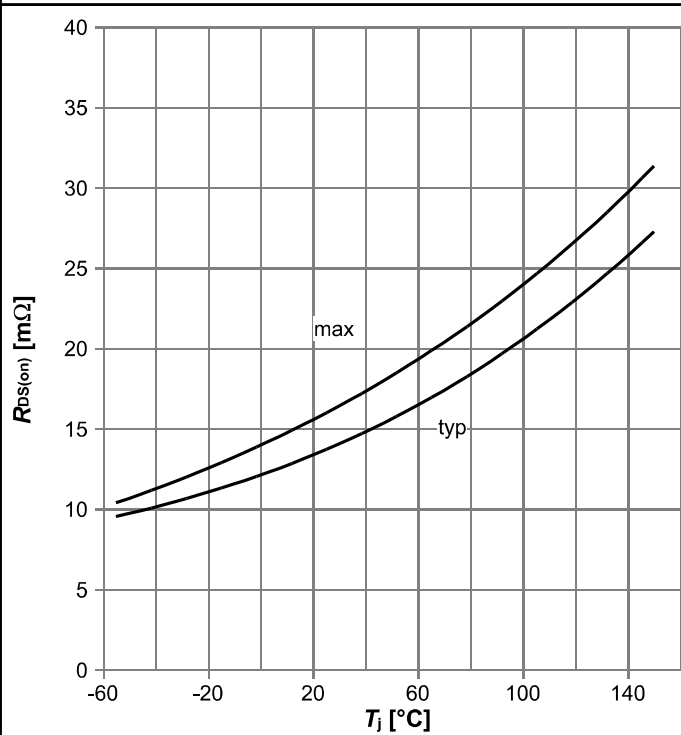

$R_{DS(on)}=f(T_j)$; $I_D=28$ A; $V_{GS}=10$ V

Diagram 10: Typ. gate threshold voltage

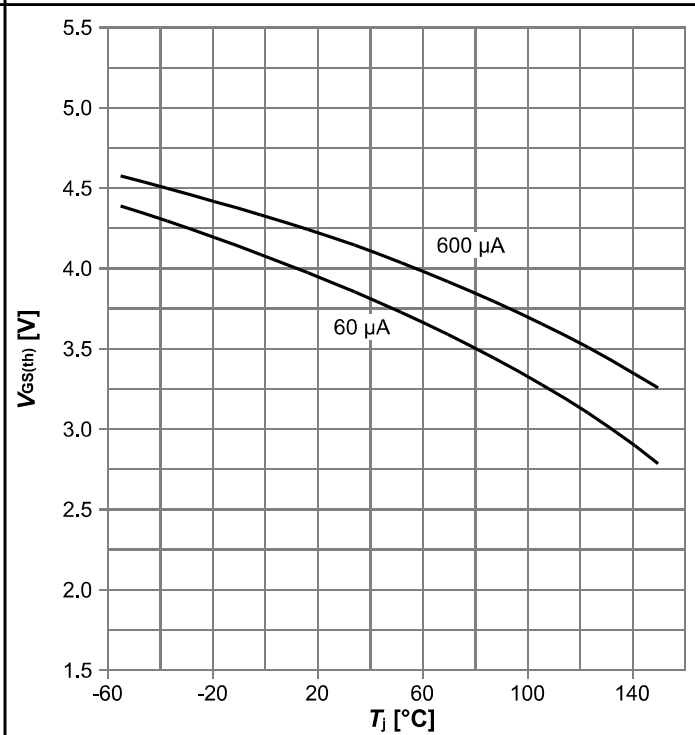

$V_{GS(th)}=f(T_j)$; $V_{GS}=V_{DS}$; parameter: I_D

Diagram 11: Typ. capacitances

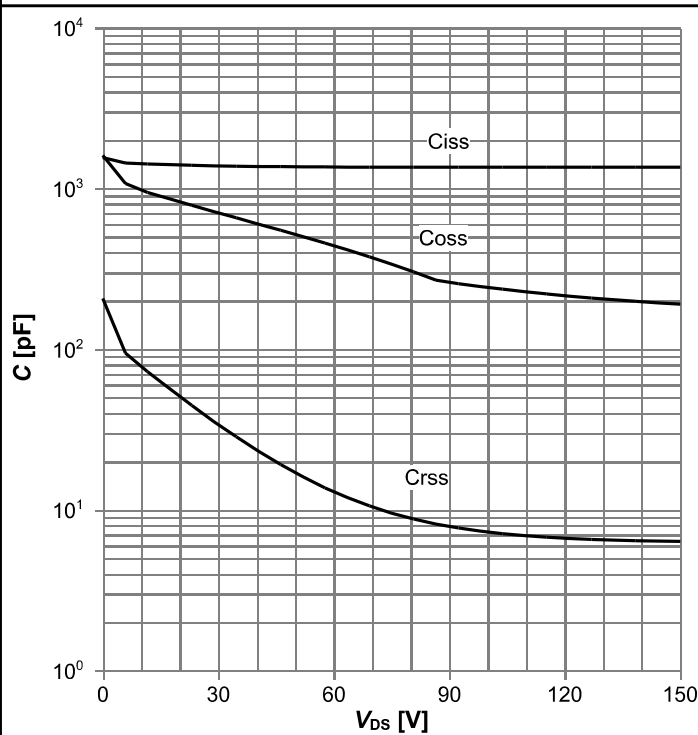

$C=f(V_{DS})$; $V_{GS}=0$ V; $f=1$ MHz

Diagram 12: Forward characteristics of reverse diode

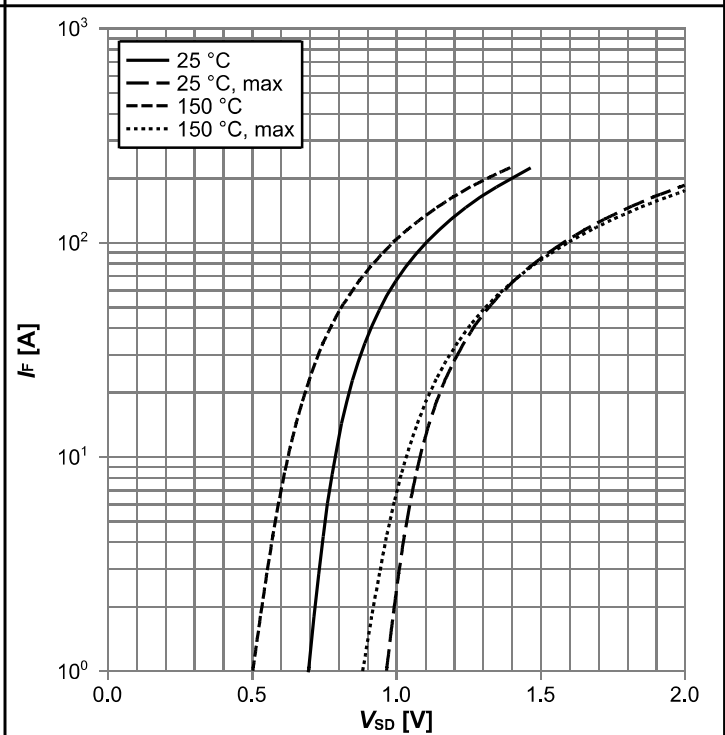

$I_F=f(V_{SD})$; parameter: T_j

Diagram 13: Avalanche characteristics

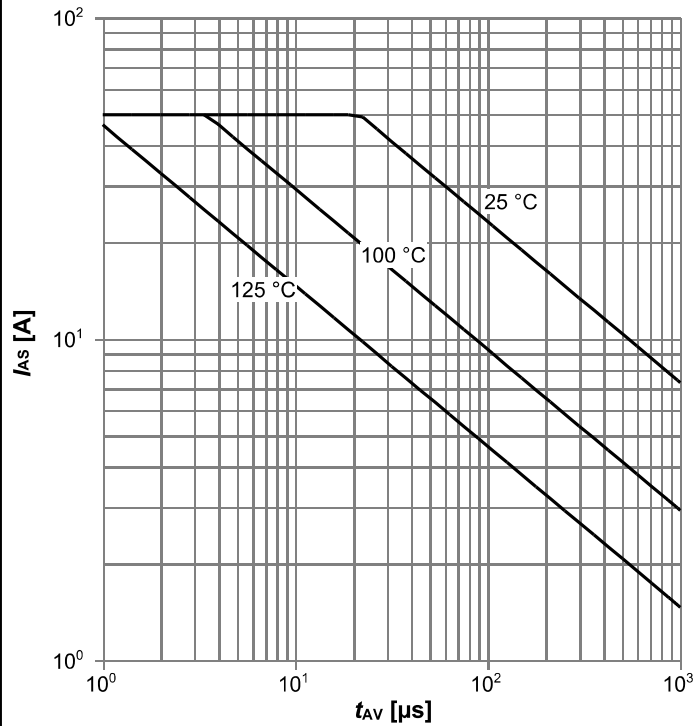

$I_{AS}=f(t_{AV}); R_{GS}=25 \Omega$; parameter: $T_{j(start)}$

Diagram 14: Typ. gate charge

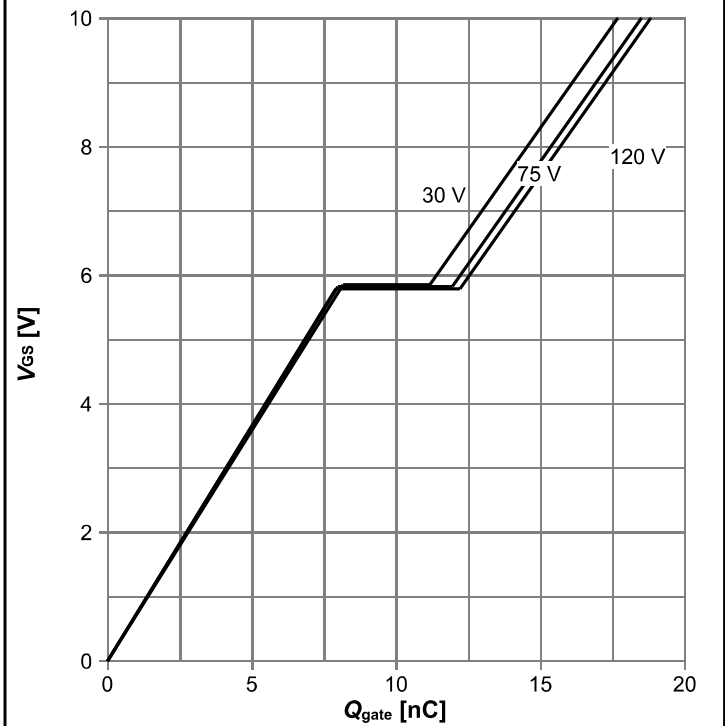

$V_{GS}=f(Q_{gate}); I_D=28A$ pulsed; parameter: V_{DD}

Diagram 15: Drain-source breakdown voltage

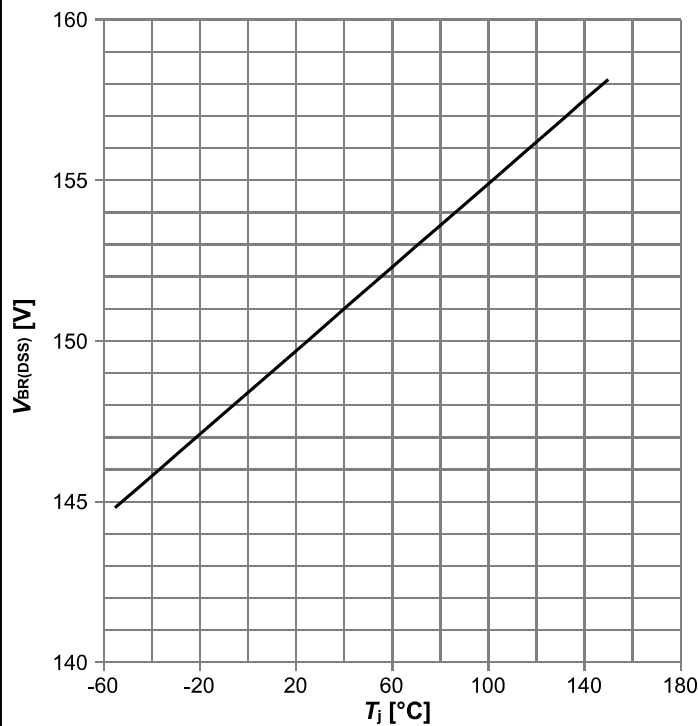

$V_{BR(DSS)}=f(T_j); I_D=1 \text{ mA}$

Diagram Gate charge waveforms

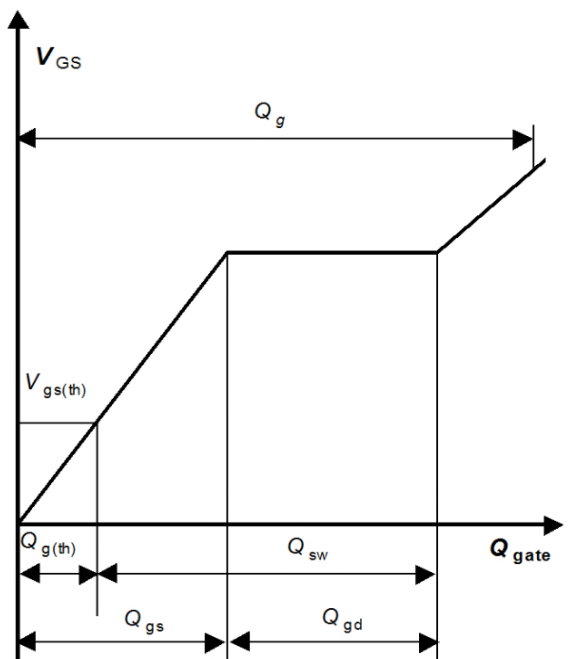

5 Package Outlines

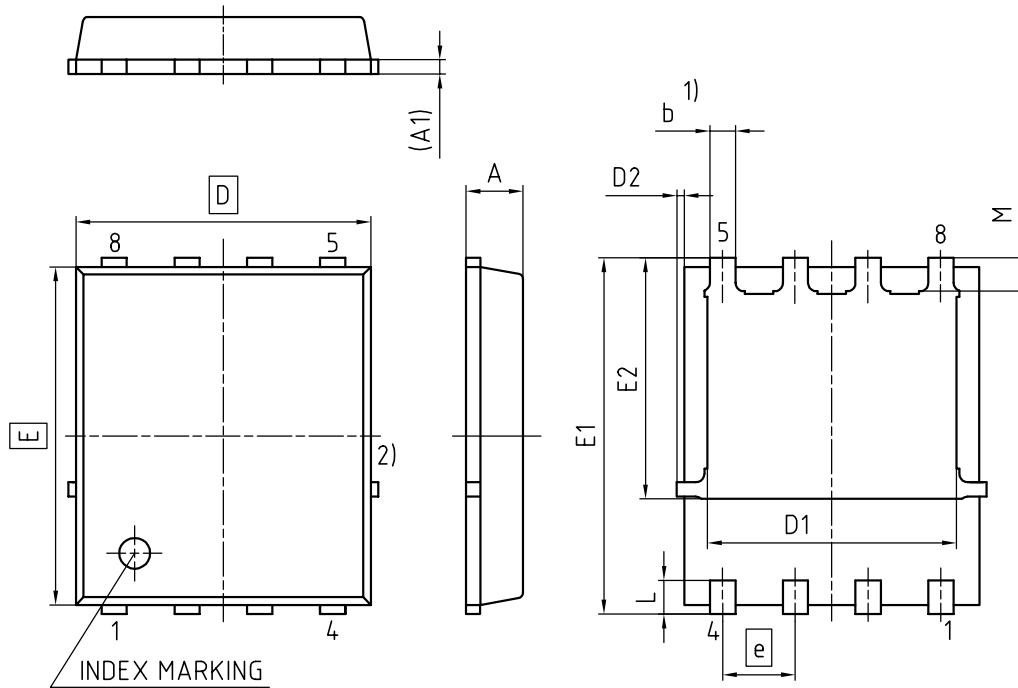

- 1) EXCLUDING MOLD FLASH
 2) REMOVAL ON MOLD GATE
 INTRUSION 0.1 MM
 PROTRUSION 0.1 MM
 LEAD LENGTH UP TO ANTI FLASH LINE
 ALL METAL SURFACES ARE PLATED, EXCEPT AREA OF CUT

DIMENSION	MILLIMETERS	
	MIN.	MAX.
A	0.90	1.20
A1	0.15	0.35
b	0.34	0.54
D	4.80	5.35
D1	3.90	4.40
D2	0.03	0.23
E	5.70	6.10
E1	5.90	6.42
E2	3.88	4.31
e	1.27	
L	0.45	0.71
M	0.45	0.69

DOCUMENT NO. Z8B00003332
REVISION 07
SCALE 10:1 0 1 2 3mm
EUROPEAN PROJECTION
ISSUE DATE 06.06.2019

Figure 1 Outline PG-TDSON-8, dimensions in mm

PG-TDSON-8: Recommended Boardpads & Apertures

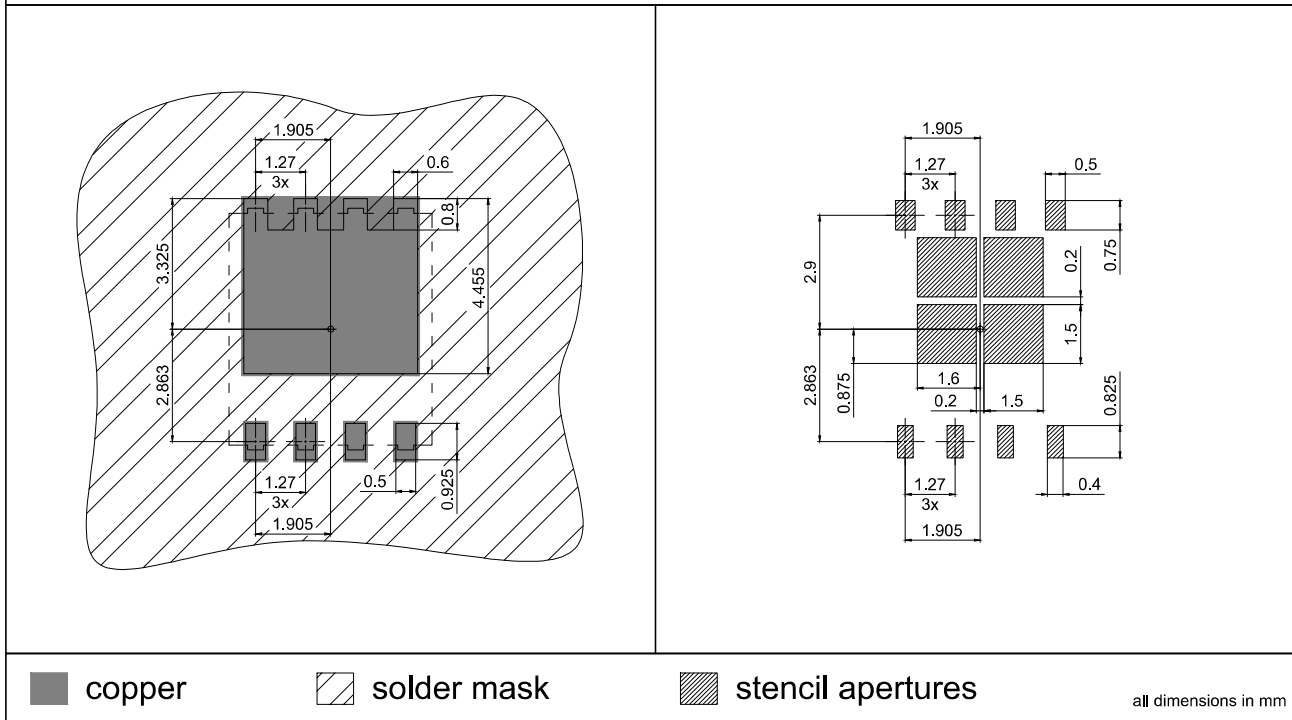

Figure 2 Outline Boardpads (TDSON-8), dimensions in mm

Revision History

BSC160N15NS5

Revision: 2021-05-20, Rev. 2.4

Previous Revision

Revision	Date	Subjects (major changes since last revision)
2.0	2015-09-23	Release of final version
2.1	2015-10-12	Rev. 2.1
2.2	2016-01-22	Update Diagram 13
2.3	2020-02-19	Update package drawings
2.4	2021-05-20	Update Diagram 11 and forward current

Trademarks

All referenced product or service names and trademarks are the property of their respective owners.

We Listen to Your Comments

Any information within this document that you feel is wrong, unclear or missing at all? Your feedback will help us to continuously improve the quality of this document. Please send your proposal (including a reference to this document) to: erratum@infineon.com

Published by

Infineon Technologies AG
81726 München, Germany
© 2020 Infineon Technologies AG
All Rights Reserved.

Legal Disclaimer

The information given in this document shall in no event be regarded as a guarantee of conditions or characteristics ("Beschaffheitsgarantie").

With respect to any examples, hints or any typical values stated herein and/or any information regarding the application of the product, Infineon Technologies hereby disclaims any and all warranties and liabilities of any kind, including without limitation warranties of non-infringement of intellectual property rights of any third party.

In addition, any information given in this document is subject to customer's compliance with its obligations stated in this document and any applicable legal requirements, norms and standards concerning customer's products and any use of the product of Infineon Technologies in customer's applications.

The data contained in this document is exclusively intended for technically trained staff. It is the responsibility of customer's technical departments to evaluate the suitability of the product for the intended application and the completeness of the product information given in this document with respect to such application.

Information

For further information on technology, delivery terms and conditions and prices please contact your nearest Infineon Technologies Office (www.infineon.com).

Warnings

Due to technical requirements, components may contain dangerous substances. For information on the types in question, please contact the nearest Infineon Technologies Office.

The Infineon Technologies component described in this Data Sheet may be used in life-support devices or systems and/or automotive, aviation and aerospace applications or systems only with the express written approval of Infineon Technologies, if a failure of such components can reasonably be expected to cause the failure of that life-support, automotive, aviation and aerospace device or system or to affect the safety or effectiveness of that device or system. Life support devices or systems are intended to be implanted in the human body or to support and/or maintain and sustain and/or protect human life. If they fail, it is reasonable to assume that the health of the user or other persons may be endangered.

Looking for pricing, stock, or lifecycle information?

Click below to explore more details on WIN SOURCE:

- ⊖ [View BSC160N15NS5ATMA1 on WIN SOURCE](#)
- ⊖ [Infineon Technologies Information](#)

Optimize Your Supply Chain with WIN SOURCE Solutions

- ✓ Global Sourcing Solution
- ✓ Obsolete Management
- ✓ Cost Control Management
- ✓ Shortage Management
- ✓ Alternative Solution
- ✓ Excess Inventory Management