



**THE DATASHEET OF
CDBHM250L-HF**



CDBHM220L-HF Thru. CDBHM2100L-HF

Reverse Voltage: 20 to 100 Volts

Forward Current: 2.0 Amp

RoHS Device

Halogen free

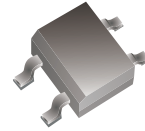

Features

- For surface mounted applications..
- Metal-Semiconductor junction with guarding.
- Epitaxial construction.
- Very low forward Voltage drop .
- High current capability
- Plastic material has UL flammability classification 94V-0
- For use in low voltage,high frequency inverters, free wheeling , and polarity protection applications.
- Pb free product.

Mechanical data

- Case: molded plastic.
- Polarity: Indicated by cathode band.
- Weight: 0.125 gram(approx.).

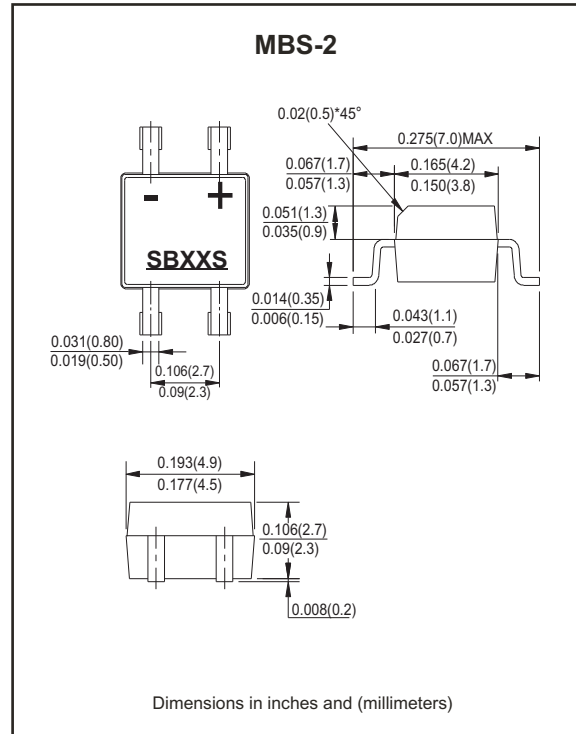

Maximum Ratings And Electrical Characteristics

Rating at $T_A=25^{\circ}\text{C}$, unless otherwise noted.
Single phase, half wave, 60Hz, resistive or inductive load.
For capacitive load, derate current by 20%.

| Parameter | Symbol | CDBHM 220L-HF | CDBHM 230L-HF | CDBHM 240L-HF | CDBHM 250L-HF | CDBHM 260L-HF | CDBHM 280L-HF | CDBHM 290L-HF | CDBHM 2100L-HF | Unit | |
|-------------------------------------------------------------------------------------------------------------------------|-----------------|---------------|---------------|---------------|---------------|---------------|---------------|---------------|----------------|-----------------------------|----|
| | Marking | SB22S | SB23S | SB24S | SB25S | SB26S | SB28S | SB29S | SB210S | | |
| Maximum Recurrent Peak Reverse Voltage | V_{RRM} | 20 | 30 | 40 | 50 | 60 | 80 | 90 | 100 | V | |
| Maximum RMS Voltage | V_{RMS} | 14 | 21 | 28 | 35 | 42 | 56 | 63 | 70 | V | |
| Maximum DC Blocking Voltage | V_{DC} | 20 | 30 | 40 | 50 | 60 | 80 | 90 | 100 | V | |
| Maximum Average Forward Rectified Current @ $T_L=100^{\circ}\text{C}$ | $I_{(AV)}$ | 2.0 | | | | | | | | A | |
| Peak Forward Surge Current, 8.3mS single half sine-wave, superimposed on rated load (JEDEC Method) | I_{FSM} | 50 | | | | | | | | A | |
| Maximum Forward Voltage at 2.0A DC | V_F | 0.55 | | | 0.70 | | 0.85 | | | V | |
| Maximum DC Reverse Current at Rated DC Blocking Voltage @ $T_J=25^{\circ}\text{C}$ @ $T_J=100^{\circ}\text{C}$ | I_R | | | | | 1.0 20 | | | | | mA |
| Typical Junction Capacitance (Note 1) | C_J | 125 | | | | | | | | pF | |
| Typical Thermal Resistance (Note 2) | $R_{\theta JA}$ | 20 | | | | | | | | $^{\circ}\text{C}/\text{W}$ | |
| Operating Temperature Range | T_J | -55 to +125 | | | | | | | | $^{\circ}\text{C}$ | |
| Storage Temperature Range | T_{STG} | -55 to +150 | | | | | | | | $^{\circ}\text{C}$ | |

Notes: 1. Measured at 1.0MHz and applied reverse voltage of 4.0V DC.
2. Thermal resistance Junction to lead.

Company reserves the right to improve product design , functions and reliability without notice.

REV: B

Low Vf SMD Schottky Bridge Rectifiers

RATING AND CHARACTERISTIC CURVES (CDBHM220L-HF Thru. CDBHM2100L-HF)

FIG. 1 - FORWARD CURRENT DERATING CURVE

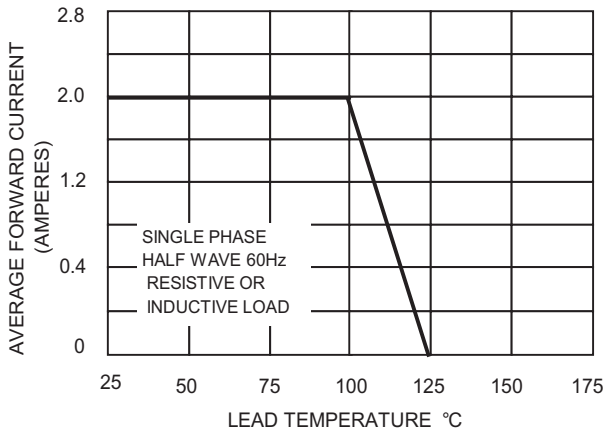

FIG. 2 - MAXIMUM NON-REPETITIVE SURGE CURRENT

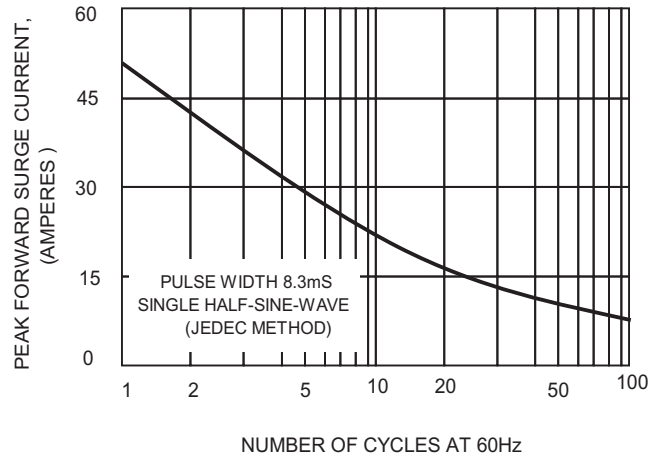

FIG.3-TYPICAL FORWARD CHARACTERISTICS

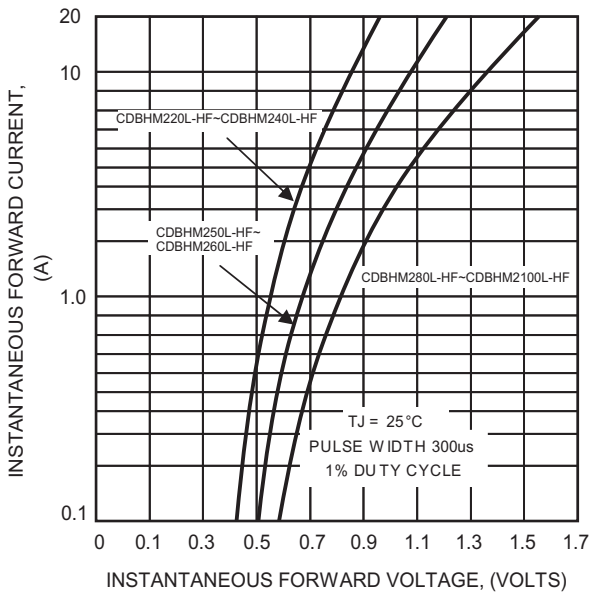

FIG.4-TYPICAL JUNCTION CAPACITANCE

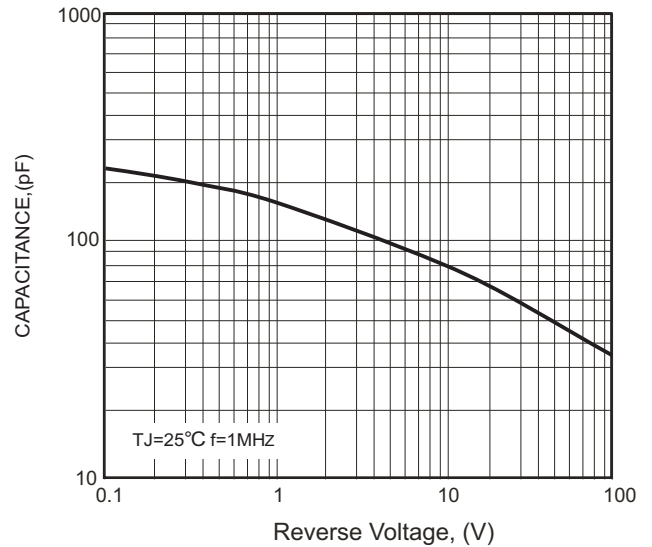
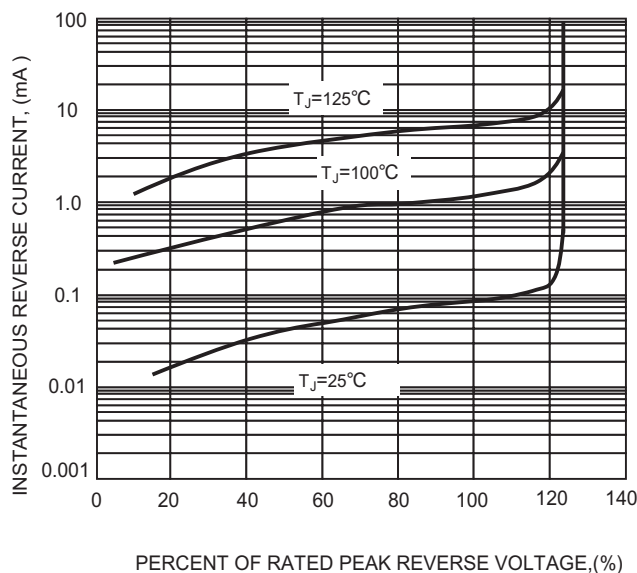
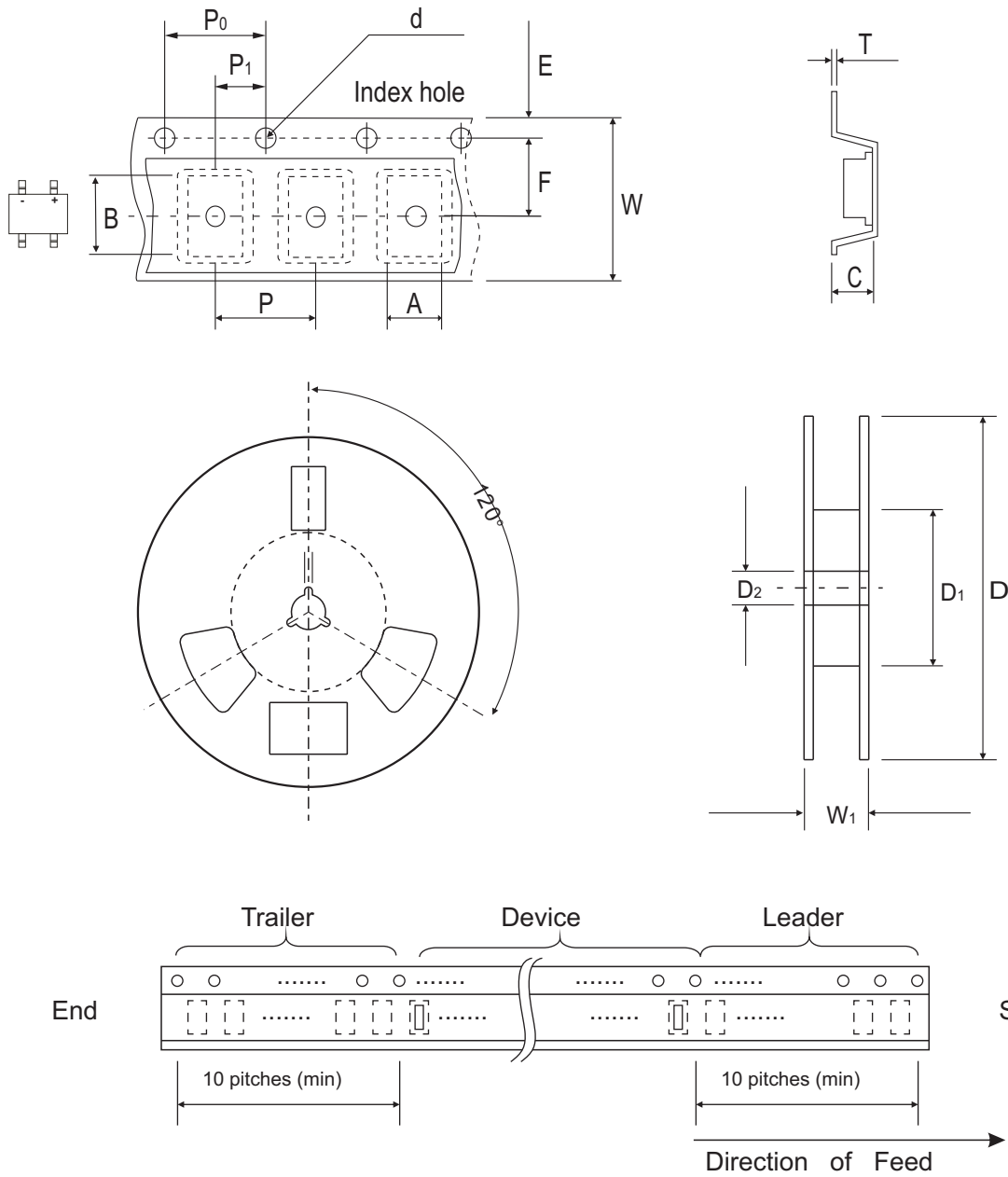

FIG.5-TYPICAL REVERSE CHARACTERISTICS



Reel Taping Specification



| MBS-2 | SYMBOL | A | B | C | d | D | D ₁ | D ₂ |
|-------|--------|--------------|---------------|---------------|----------------|-------|----------------|----------------|
| | (mm) | 4.90 ± 0.01 | 7.24 ± 0.10 | 3.33 ± 0.10 | 1.55 ± 0.10 | 330.0 | 50.0 MIN. | 13.0 ± 0.20 |
| | (inch) | 0.93 ± 0.004 | 0.285 ± 0.004 | 0.131 ± 0.004 | 0.0610 ± 0.004 | 13.00 | 1.969 MIN. | 0.512 ± 0.008 |

| MBS-2 | SYMBOL | E | F | P | P ₀ | P ₁ | W | W ₁ |
|-------|--------|---------------|---------------|---------------|----------------|----------------|---------------|----------------|
| | (mm) | 1.75 ± 0.10 | 5.50 ± 0.05 | 8.00 ± 0.10 | 4.00 ± 0.10 | 2.00 ± 0.05 | 12.00 ± 0.30 | 12.0~14.40 |
| | (inch) | 0.069 ± 0.004 | 0.217 ± 0.002 | 0.315 ± 0.004 | 0.157 ± 0.004 | 0.079 ± 0.002 | 0.472 ± 0.012 | 0.472~0.657 |

Suggested PAD Layout

| SIZE | MBS-2 | |
|------|----------|-----------|
| | (mm) | (inch) |
| A | 2.55 REF | 0.100 REF |
| B | 0.82 MIN | 0.032MIN |
| C | 0.92 MIN | 0.036 MIN |
| D | 7.00 MAX | 0.276MAX |

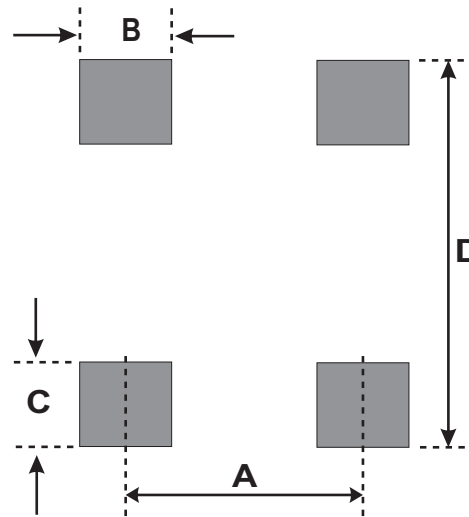



Standard Packaging

| Case Type | REEL PACK | |
|-----------|--------------|------------------|
| | REEL (pcs) | Reel Size (inch) |
| MBS-2 | 3,000 | 13 |

Looking for pricing, stock, or lifecycle information?

Click below to explore more details on WIN SOURCE:

-  [View CDBHM250L-HF on WIN SOURCE](#)
-  [Comchip Technology Information](#)

Optimize Your Supply Chain with WIN SOURCE Solutions

-  Global Sourcing Solution
-  Obsolete Management
-  Cost Control Management
-  Shortage Management
-  Alternative Solution
-  Excess Inventory Management