



**THE DATASHEET OF
ACGRKM4003-HF**



ACGRKM4001-HF Thru. ACGRKM4007-HF

Reverse Voltage: 50 to 1000 Volts

Forward Current: 1.0 Amp

RoHS Device

Halogen Free

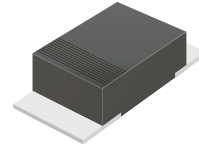

Features

- Ideal for surface mount applications
- Easy pick and place
- Exceeds environmental standard MIL-STD-19500/228
- Low leakage current
- Comply with AEC-Q101

Mechanical data

- Epoxy: UL94V-0 rated flame retardant
- Case: Molded plastic, SOD-123F
- Terminals: Solderable per MIL-STD-750, method 2026
- Polarity: Indicated by cathode band
- Weight: 0.027 grams approx.

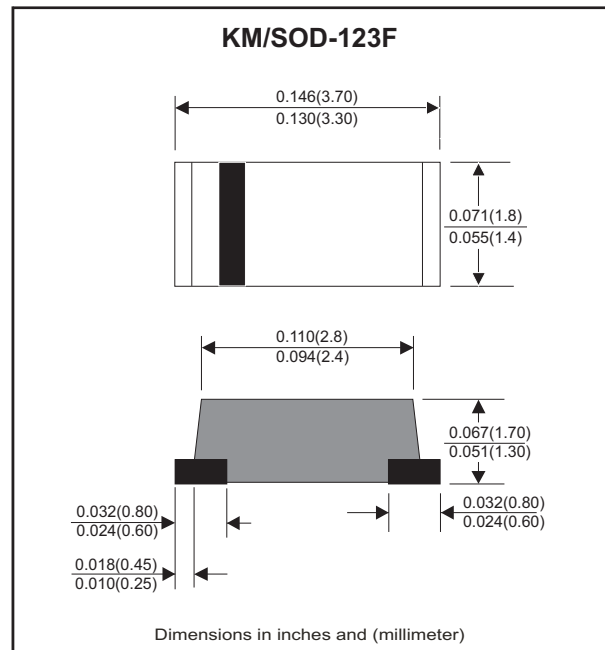

Circuit diagram



Maximum Ratings (at T_A=25°C unless otherwise noted)

Parameter	Symbol	ACGRKM 4001-HF	ACGRKM 4002-HF	ACGRKM 4003-HF	ACGRKM 4004-HF	ACGRKM 4005-HF	ACGRKM 4006-HF	ACGRKM 4007-HF	Unit	
Maximum repetitive peak reverse voltage	V _{RRM}	50	100	200	400	600	800	1000	V	
Maximum DC blocking voltage	V _{DC}	50	100	200	400	600	800	1000	V	
Maximum RMS voltage	V _{RMS}	35	70	140	280	420	560	700	V	
Maximum averaged forward current	I _O	1.0								A
Maximum Instantaneous forward voltage at I _F =1.0A	V _F	1.1				1.0	1.1		V	
Forward surge current, 8.3ms single half sine-wave superimposed on rated load (JEDEC method)	I _{FSM}	30							A	
Reverse current at rated DC blocking voltage	I _R	@T _A =25°C	5							μA
		@T _A =100°C	50							
Thermal resistance, junction to ambient air	R _{θJA}	60							°C/W	
Operating junction temperature	T _J	-55 to +150							°C	
Storage temperature range	T _{STG}	-65 to +170							°C	
Junction capacitance f=1MHz and applied 4V DC reverse voltage	C _J	15							pF	

Company reserves the right to improve product design, functions and reliability without notice.

REV:C

Rating and Characteristic Curves (ACGRKM4001-HF Thru. ACGRKM4007-HF)

Fig.1- Current Derating Curve

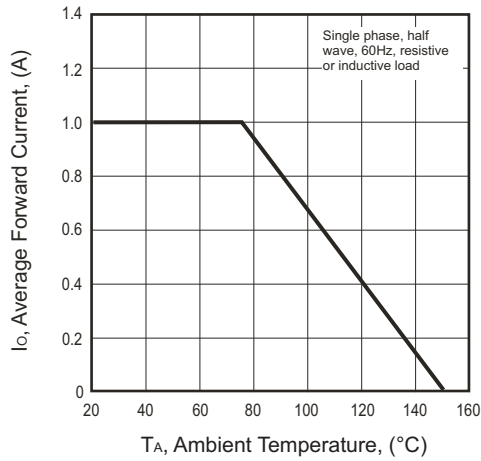

Fig.2- Forward Characteristics

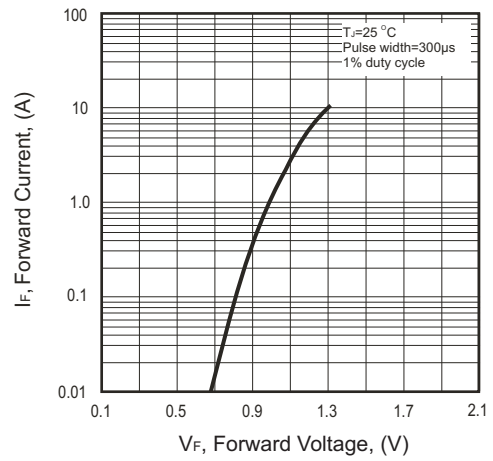

Fig.3- Non-repetitive Forward Surge Current

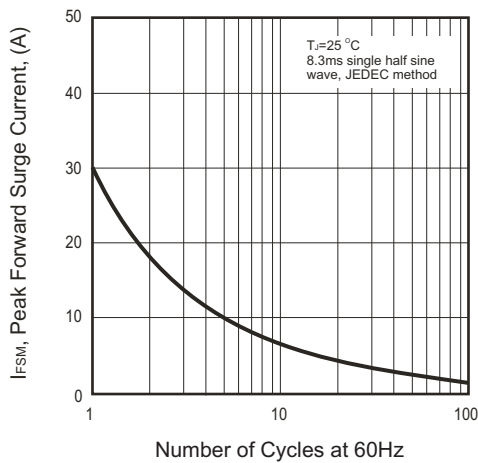

Fig.4- Reverse Characteristics

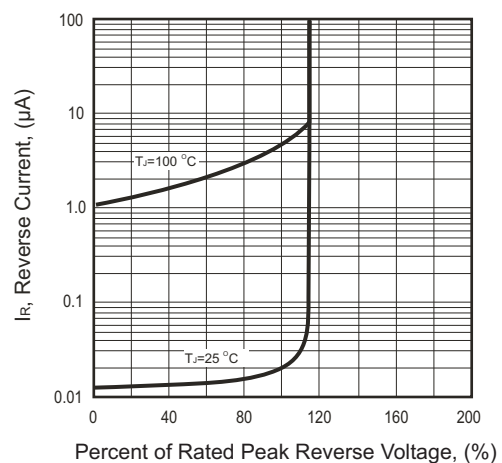
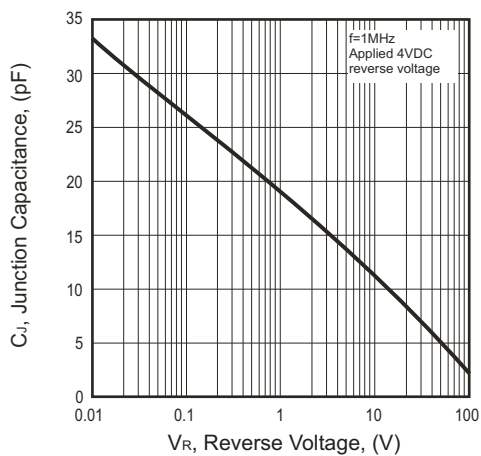

Fig.5- Junction Capacitance



Company reserves the right to improve product design, functions and reliability without notice.

REV:C

Reel Taping Specification

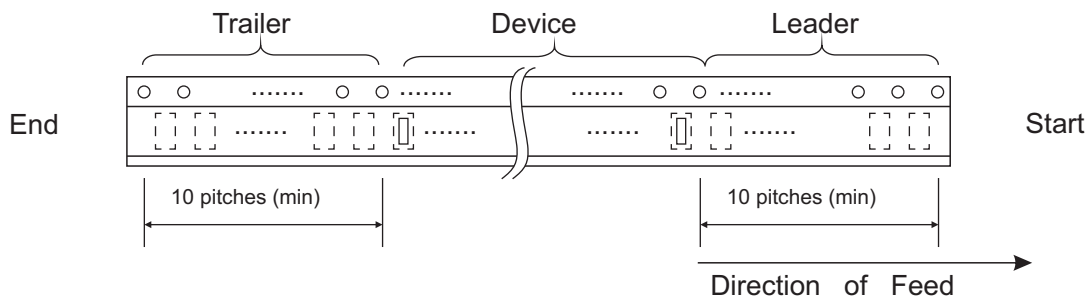
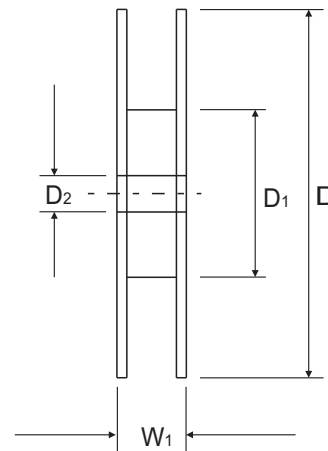
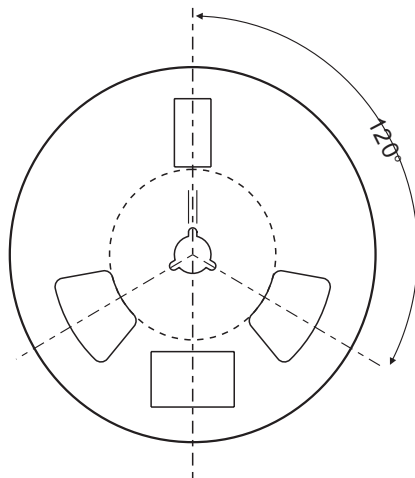
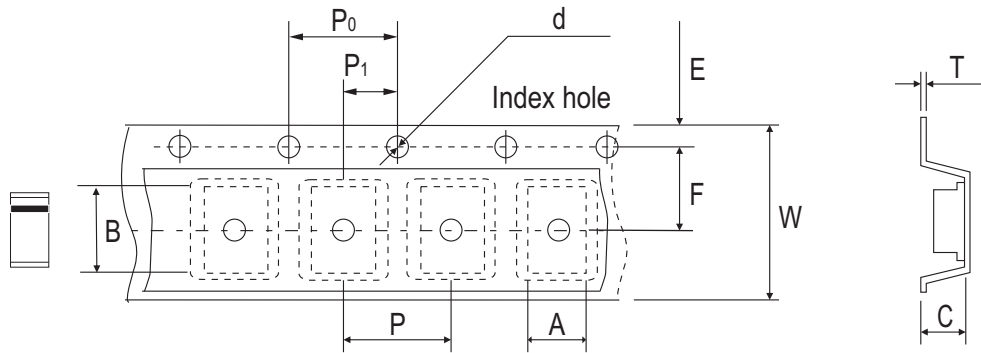

KM/ SOD-123F	SYMBOL	A	B	C	d	D	D1	D2
	(mm)	1.90 ± 0.10	3.90 ± 0.10	1.68 ± 0.10	1.50 ± 0.10	178 ± 2.00	62.0 MIN.	13.0 ± 0.50
	(inch)	0.075 ± 0.04	0.154 ± 0.04	0.066 ± 0.04	0.059 ± 0.004	7.00 ± 0.079	2.440 MIN.	0.512 ± 0.020

KM/ SOD-123F	SYMBOL	E	F	P	P0	P1	T	W	W1
	(mm)	1.75 ± 0.10	3.50 ± 0.10	4.00 ± 0.10	4.00 ± 0.10	2.00 ± 0.10	0.23 ± 0.10	8.00 ± 0.30	11.40 ± 1.0
	(inch)	0.069 ± 0.004	0.138 ± 0.004	0.157 ± 0.004	0.157 ± 0.004	0.079 ± 0.004	0.009 ± 0.004	0.315 ± 0.012	0.449 ± 0.004

Company reserves the right to improve product design, functions and reliability without notice. REV:C

Marking Code

Part Number	Marking Code
ACGRKM4001(T)-HF	A1
ACGRKM4002(T)-HF	A2
ACGRKM4003(T)-HF	A3
ACGRKM4004(T)-HF	A4
ACGRKM4005(T)-HF	A5
ACGRKM4006(T)-HF	A6
ACGRKM4007(T)-HF	A7

Note:

1) Suffix code after part number to specify packaging item .

Packaging	Code
REEL PACK 7"	NA
REEL PACK 13"	T

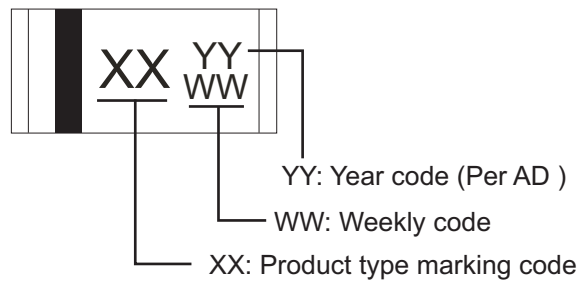

- Year Code: The last two number, AD 2016=16
- Weekly Code: 01~xx(The fast week~final week)

Product code printed

For example as follows:

P/N: ACGRKM4005-HF

Manufacture date_ Year: 2016 / Weekly:01

Product code printed:

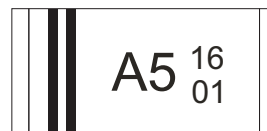

Suggested PAD Layout

SIZE	KM/SOD-123F	
	(mm)	(inch)
A	3.30	0.130
B	1.40	0.055
C	1.90	0.075
D	4.70	0.185
E	1.90	0.075

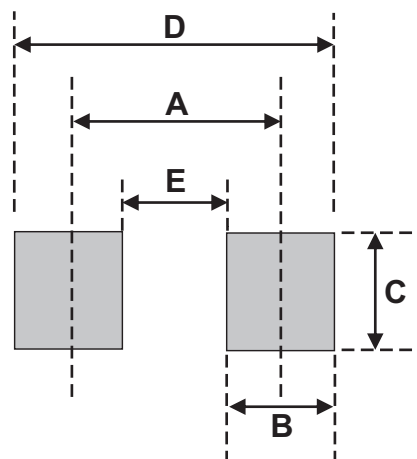

Standard Packaging

Case Type	REEL PACK	
	REEL (pcs)	Reel Size (inch)
KM/ SOD-123F	2,500	7
	10,000	13

Looking for pricing, stock, or lifecycle information?

Click below to explore more details on WIN SOURCE:

- ⊖ [View ACGRKM4003-HF](#) on WIN SOURCE
- ⊖ [Comchip Technology](#) Information

Optimize Your Supply Chain with WIN SOURCE Solutions

- ✓ Global Sourcing Solution
- ✓ Obsolete Management
- ✓ Cost Control Management
- ✓ Shortage Management
- ✓ Alternative Solution
- ✓ Excess Inventory Management