



**THE DATASHEET OF
BAW56E6433**



Silicon Switching Diode

- For high-speed switching applications
- Common anode configuration
- BAW56S / U: For orientation in reel see package information below
- Pb-free (RoHS compliant) package¹⁾
- Qualified according AEC Q101

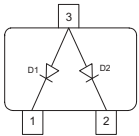
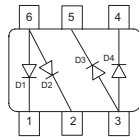
BAW56
BAW56W

BAW56S
BAW56U

Type	Package	Configuration	Marking
BAW56	SOT23	common anode	A1s
BAW56S	SOT363	double common anode	A1s
BAW56U	SC74	double common anode	A1s
BAW56W	SOT323	common anode	A1s

¹Pb-containing package may be available upon special request

Maximum Ratings at $T_A = 25^\circ\text{C}$, unless otherwise specified

Parameter	Symbol	Value	Unit
Diode reverse voltage	V_R	80	V
Peak reverse voltage	V_{RM}	85	
Forward current	I_F	200	mA
Non-repetitive peak surge forward current	I_{FSM}		A
$t = 1 \mu\text{s}$		4.5	
$t = 1 \text{ ms}$		1	
$t = 1 \text{ s, single}$		0.5	
$t = 1 \text{ s, double}$		0.75	
Total power dissipation	P_{tot}		mW
BAW56, $T_S \leq 28^\circ\text{C}$		330	
BAW56S, $T_S \leq 85^\circ\text{C}$		250	
BAW56U, $T_S \leq 90^\circ\text{C}$		250	
BAW56W, $T_S \leq 103^\circ\text{C}$		250	
Junction temperature	T_j	150	$^\circ\text{C}$
Storage temperature	T_{stg}	-65 ... 150	

Thermal Resistance

Parameter	Symbol	Value	Unit
Junction - soldering point ¹⁾	R_{thJS}		K/W
BAW56		360	
BAW56S		260	
BAW56U		240	
BAW56W		190	

¹⁾For calculation of R_{thJA} please refer to Application Note Thermal Resistance

Electrical Characteristics at $T_A = 25^\circ\text{C}$, unless otherwise specified

Parameter	Symbol	Values			Unit
		min.	typ.	max.	
DC Characteristics					
Breakdown voltage $I_{(BR)} = 100 \mu\text{A}$	$V_{(BR)}$	85	-	-	V
Reverse current $V_R = 70 \text{ V}$ $V_R = 25 \text{ V}, T_A = 150^\circ\text{C}$ $V_R = 70 \text{ V}, T_A = 150^\circ\text{C}$	I_R	-	-	0.15 30 50	μA
Forward voltage $I_F = 1 \text{ mA}$ $I_F = 10 \text{ mA}$ $I_F = 50 \text{ mA}$ $I_F = 100 \text{ mA}$ $I_F = 150 \text{ mA}$	V_F	-	-	715 855 1000 1200 1250	mV

AC Characteristics

Diode capacitance $V_R = 0 \text{ V}, f = 1 \text{ MHz}$	C_T	-	-	2	pF
Reverse recovery time $I_F = 10 \text{ mA}, I_R = 10 \text{ mA}$, measured at $I_R = 1 \text{ mA}$, $R_L = 100 \Omega$	t_{rr}	-	-	4	ns

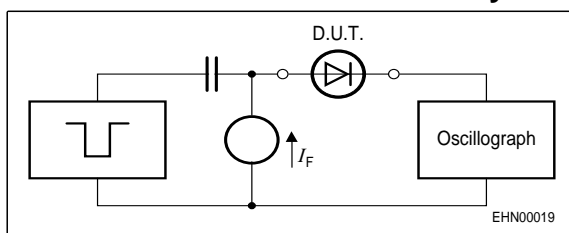
Test circuit for reverse recovery time

Pulse generator: $t_p = 100\text{ns}$, $D = 0.05$, $t_r = 0.6\text{ns}$,
 $R_i = 50\Omega$

Oscilloscope: $R = 50\Omega$, $t_r = 0.35\text{ns}$, $C \leq 1\text{pF}$

Reverse current $I_R = f(T_A)$

$V_R = \text{Parameter}$

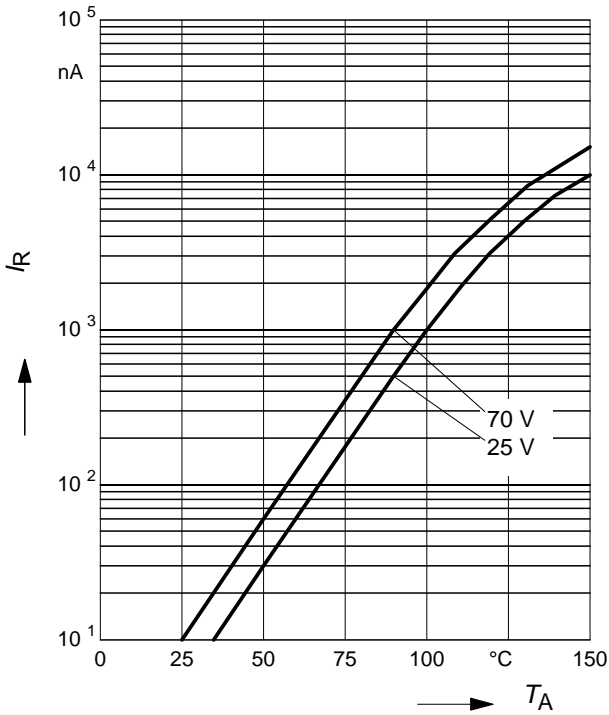

Forward Voltage $V_F = f(T_A)$

$I_F = \text{Parameter}$

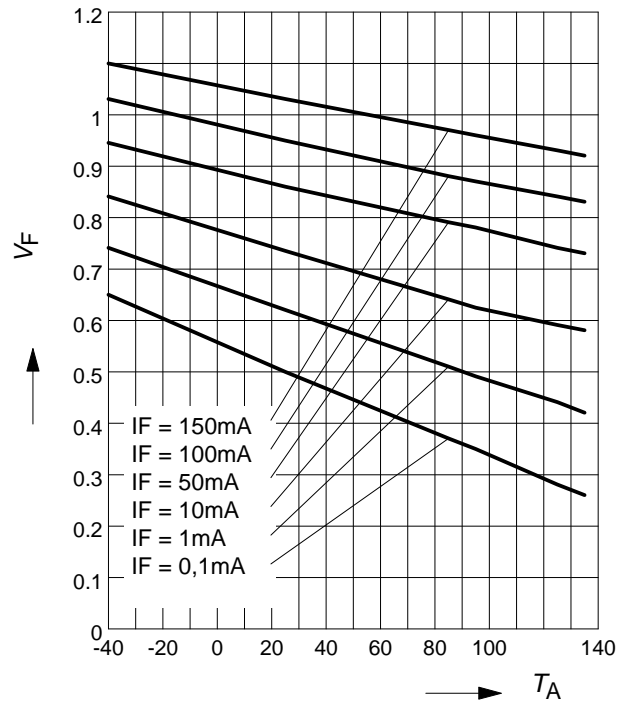

Forward current $I_F = f(V_F)$

$T_A = 25^\circ\text{C}$

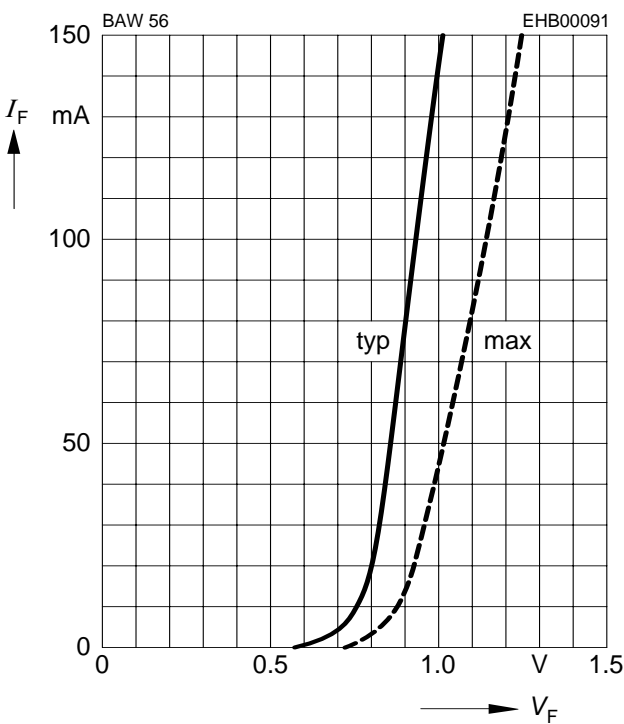

Forward current $I_F = f(T_S)$

BAW56

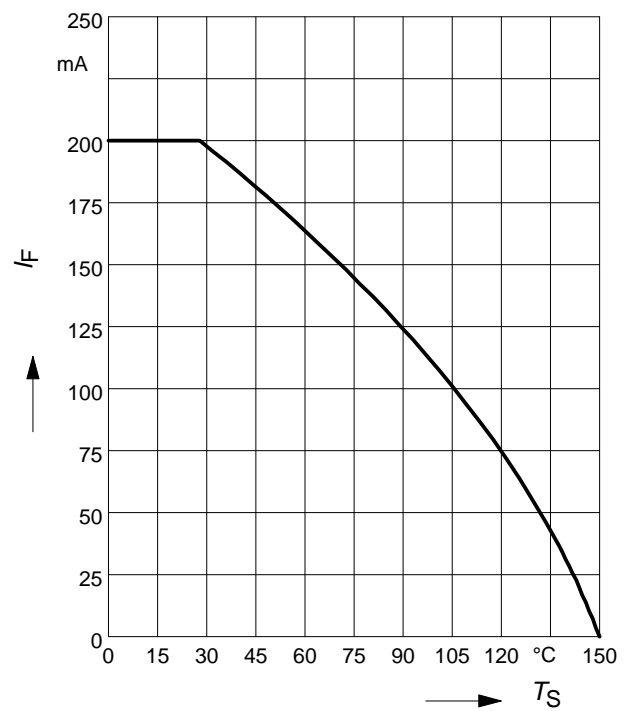

Forward current $I_F = f(T_S)$

BAW56S

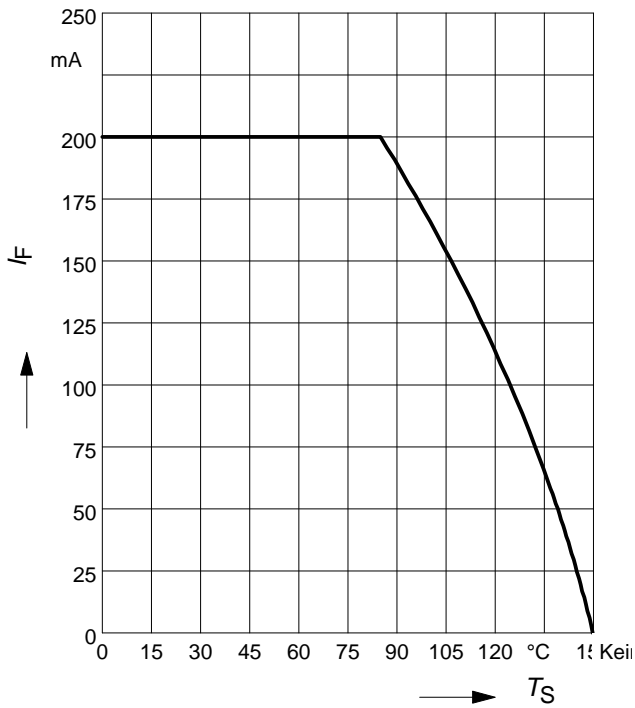

Forward current $I_F = f(T_S)$

BAW56U

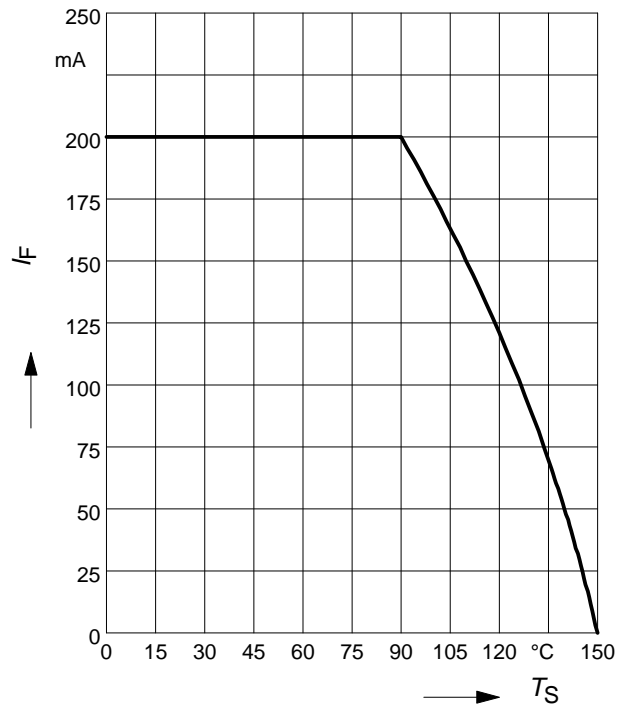

Forward current $I_F = f(T_S)$

BAW56W

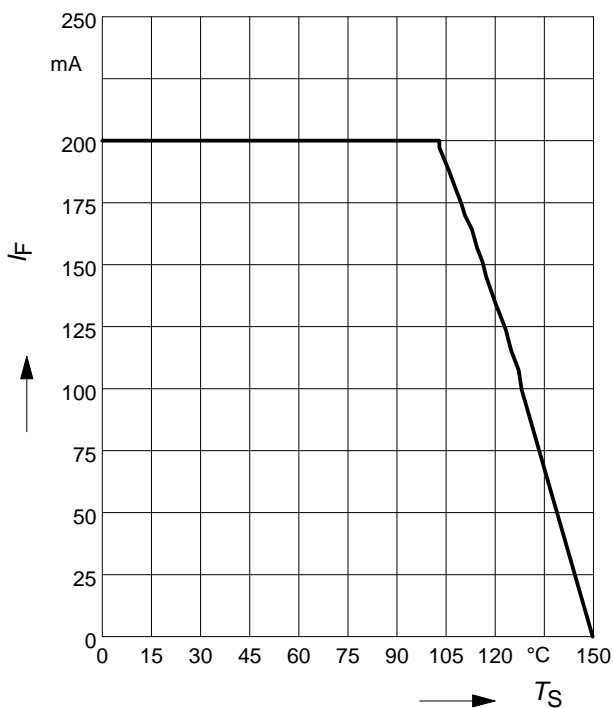

Permissible Puls Load $R_{thJS} = f(t_p)$

BAW56

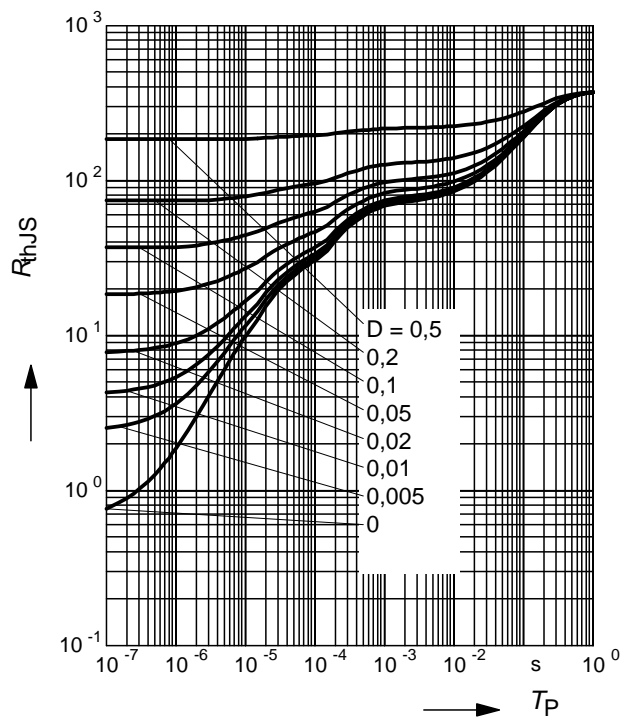

Permissible Pulse Load

$I_{Fmax} / I_{FDC} = f(t_p)$

BAW56

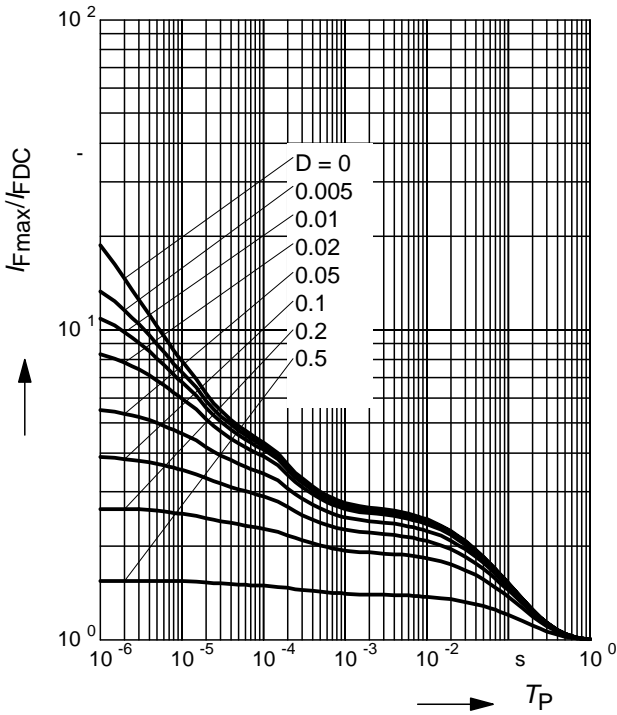

Permissible Puls Load $R_{thJS} = f(t_p)$

BAW56S

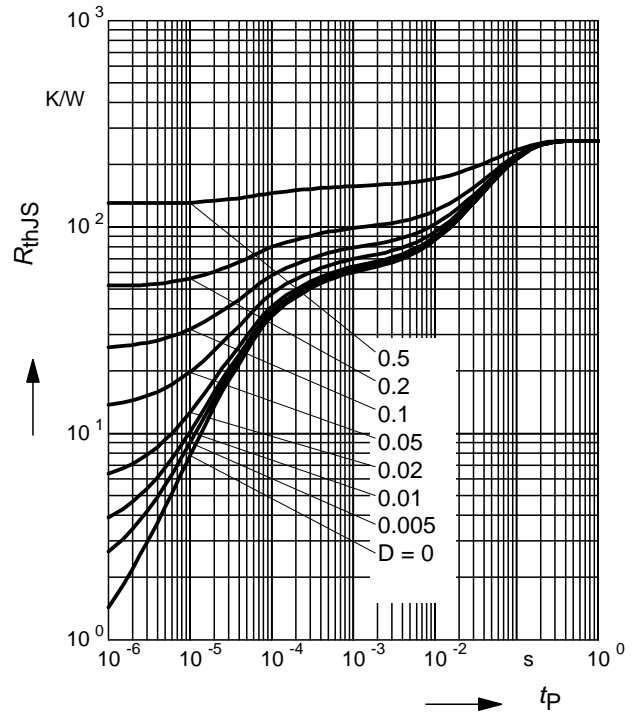

Permissible Pulse Load

$I_{Fmax} / I_{FDC} = f(t_p)$

BAW56S

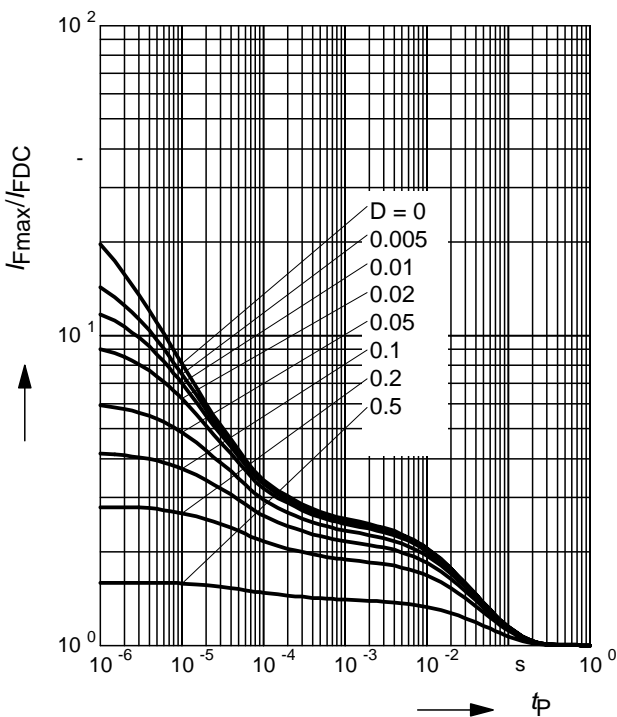

Permissible Puls Load $R_{thJS} = f(t_p)$

BAW56U

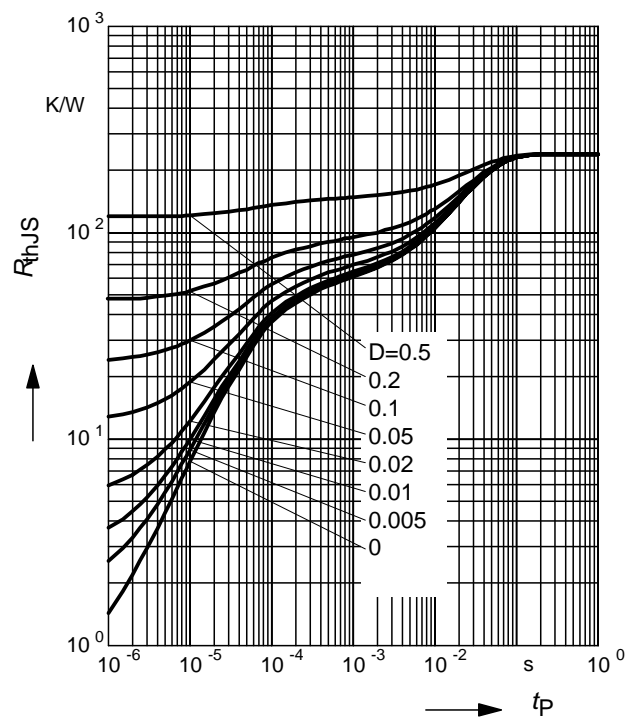

Permissible Pulse Load

$$I_{Fmax} / I_{FDC} = f(t_p)$$

BAW56U

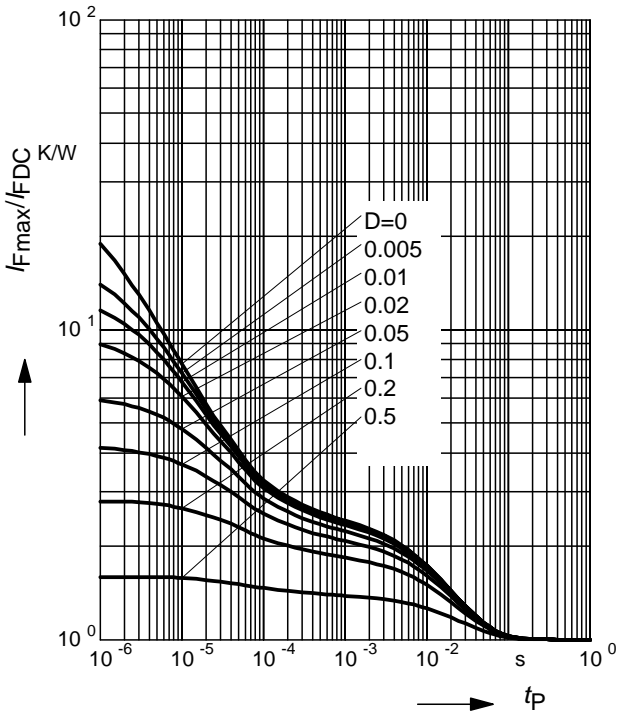

Permissible Puls Load $R_{thJS} = f(t_p)$

BAW56W

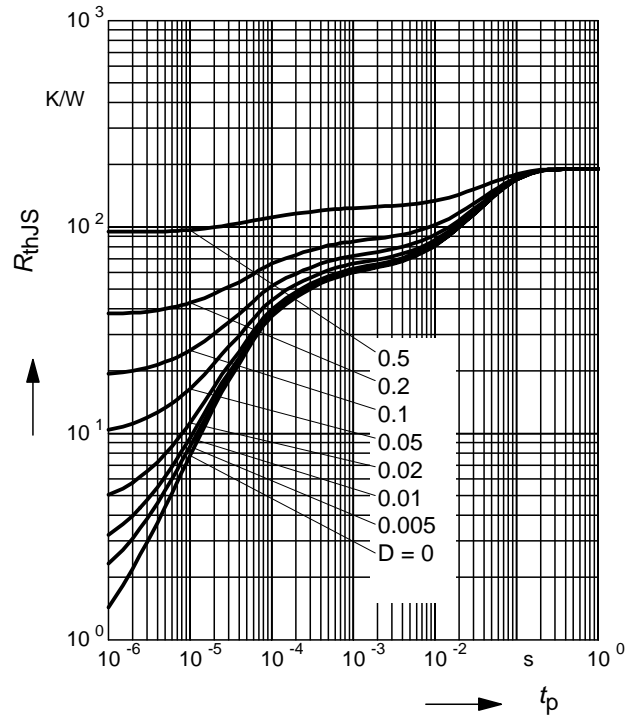

Permissible Pulse Load

$$I_{Fmax} / I_{FDC} = f(t_p)$$

BAW56W

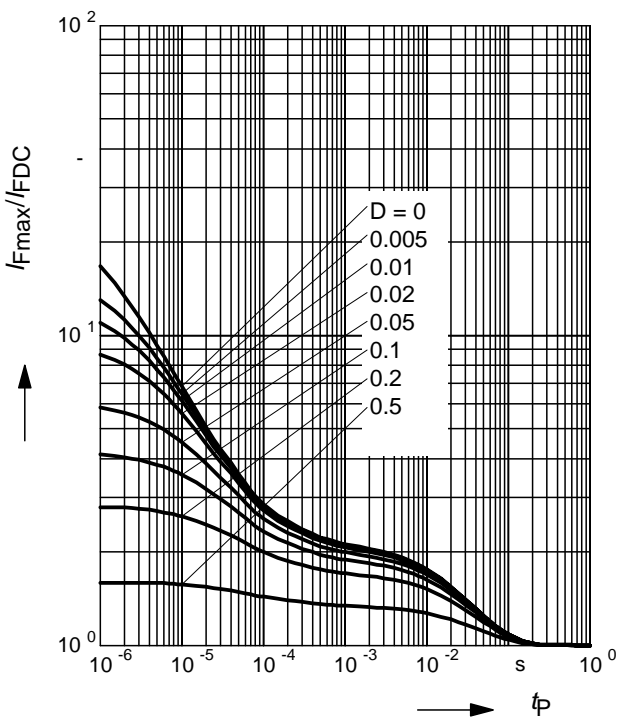

Package Outline



Foot Print



Marking Layout (Example)

Small variations in positioning of Date code, Type code and Manufacture are possible.



Standard Packing

Reel \varnothing 180 mm = 3.000 Pieces/Reel
 Reel \varnothing 330 mm = 10.000 Pieces/Reel

For symmetric types no defined Pin 1 orientation in reel.



Package Outline



1) Lead width can be 0.6 max. in dambar area

Foot Print

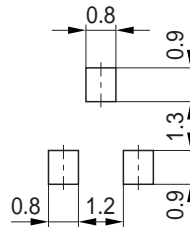

Marking Layout (Example)

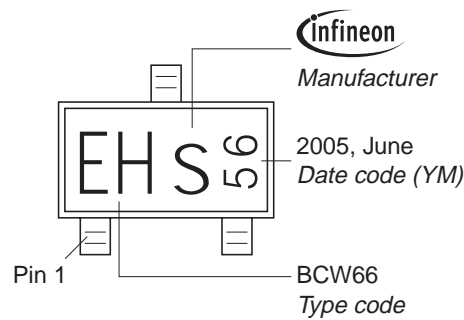

Standard Packing

Reel \varnothing 180 mm = 3.000 Pieces/Reel
 Reel \varnothing 330 mm = 10.000 Pieces/Reel

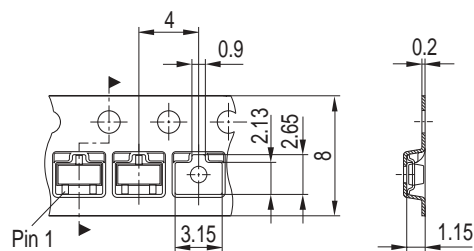

Package Outline

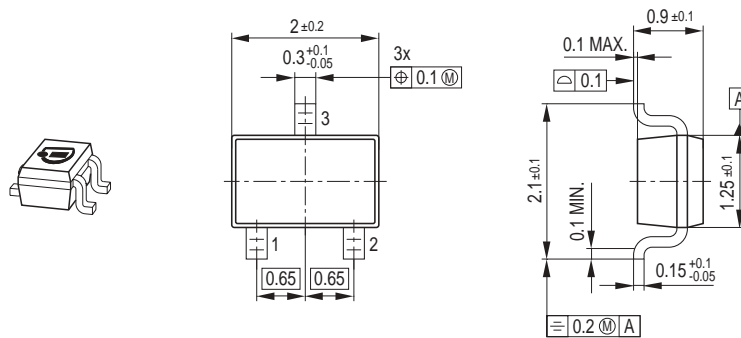

Foot Print



Marking Layout (Example)



Standard Packing

Reel \varnothing 180 mm = 3.000 Pieces/Reel
 Reel \varnothing 330 mm = 10.000 Pieces/Reel

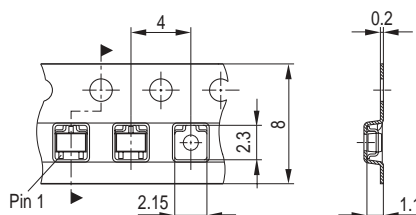

Package Outline

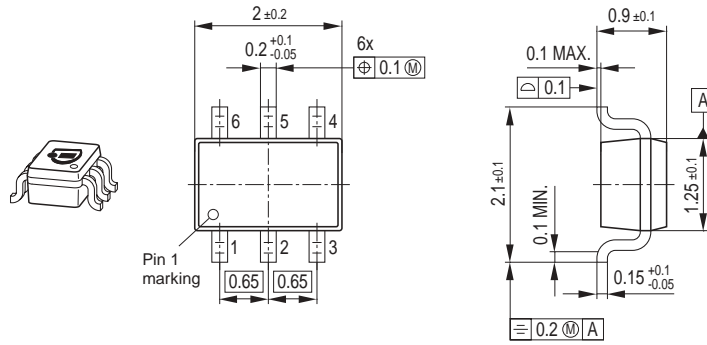

Foot Print

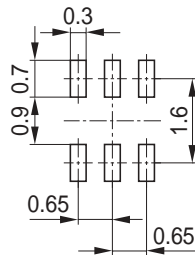

Marking Layout (Example)

Small variations in positioning of Date code, Type code and Manufacture are possible.

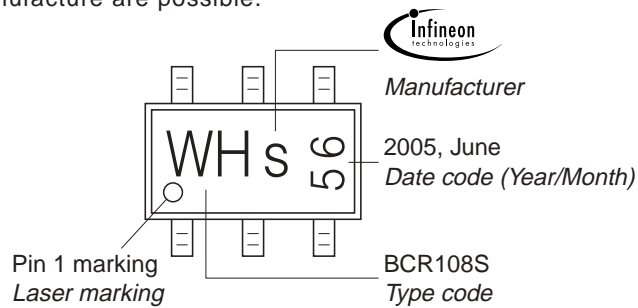

Standard Packing

Reel \varnothing 180 mm = 3.000 Pieces/Reel
 Reel \varnothing 330 mm = 10.000 Pieces/Reel

For symmetric types no defined Pin 1 orientation in reel.

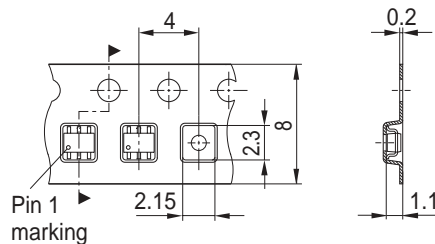

Edition 2006-02-01

Published by

Infineon Technologies AG

81726 München, Germany

© Infineon Technologies AG 2007.

All Rights Reserved.

Attention please!

The information given in this dokument shall in no event be regarded as a guarantee of conditions or characteristics ("Beschaffenheitsgarantie"). With respect to any examples or hints given herein, any typical values stated herein and/or any information regarding the application of the device, Infineon Technologies hereby disclaims any and all warranties and liabilities of any kind, including without limitation warranties of non-infringement of intellectual property rights of any third party.

Information

For further information on technology, delivery terms and conditions and prices please contact your nearest Infineon Technologies Office (www.infineon.com).

Warnings

Due to technical requirements components may contain dangerous substances. For information on the types in question please contact your nearest Infineon Technologies Office.

Infineon Technologies Components may only be used in life-support devices or systems with the express written approval of Infineon Technologies, if a failure of such components can reasonably be expected to cause the failure of that life-support device or system, or to affect the safety or effectiveness of that device or system.

Life support devices or systems are intended to be implanted in the human body, or to support and/or maintain and sustain and/or protect human life. If they fail, it is reasonable to assume that the health of the user or other persons may be endangered.

Looking for pricing, stock, or lifecycle information?

Click below to explore more details on WIN SOURCE:

- ⊖ [View BAW56E6433 on WIN SOURCE](#)
- ⊖ [Infineon Technologies Information](#)

Optimize Your Supply Chain with WIN SOURCE Solutions

- ✓ Global Sourcing Solution
- ✓ Obsolete Management
- ✓ Cost Control Management
- ✓ Shortage Management
- ✓ Alternative Solution
- ✓ Excess Inventory Management