



**THE DATASHEET OF
CY23FS04ZXC-2T**



Features

- Internal DCXO for Continuous Glitch-free Operation
- Zero Input-Output Propagation Delay
- Low-Jitter (35 ps max RMS) Outputs
- Low Output-to-Output Skew (200 ps max)
- 4.17 MHz to 50 MHz Reference Input
- Supports Industry Standard Input Crystals
- 4.17 MHz to 50 MHz Outputs
- 5V-Tolerant Inputs
- Phase-Locked Loop (PLL) Bypass Mode
- Dual Reference Inputs
- 16-Pin TSSOP
- 2.5V or 3.3V Output Power Supplies
- 3.3V Core Power Supply

Functional Description

The CY23FS04-2 is a FailSafe™ zero delay buffer with two reference clock inputs and four phase-aligned outputs. The device provides an optimum solution for applications where continuous operation is required in the event of a primary clock failure.

The continuous, glitch-free operation is achieved by using a DCXO, which serves as a redundant clock source in the event of a reference clock failure by maintaining the last frequency and phase information of the reference clock.

The unique feature of the CY23FS04-2 is that the DCXO is in fact the primary clocking source, which is synchronized (phase-aligned) to the external reference clock. When this external clock is restored, the DCXO automatically resynchronizes to the external clock.

The frequency of the crystal that is connected to the DCXO must be an integer factor of the frequency of the reference clock. This factor is set by two select lines: S[2:1], see [Table 2](#). The output power supply VDD can be connected to either 2.5V or 3.3V. VDDC is the power supply pin for internal circuits and must be connected to 3.3V.

Logic Block Diagram

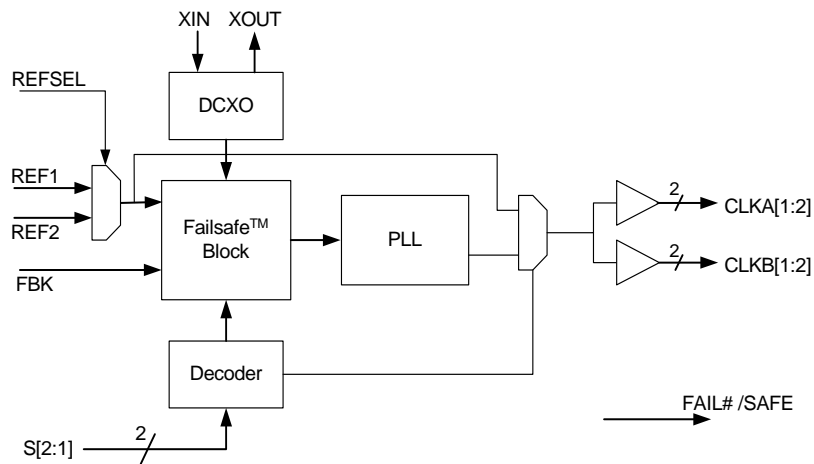

Contents

Features	1	Electrical Characteristics for FailSafe Devices	10
Functional Description	1	Switching Characteristics for FailSafe Devices	10
Logic Block Diagram	1	Ordering Information	10
Contents	2	Package Diagram	11
Pin Configuration	3	Document History Page	12
FailSafe Function	4	Sales, Solutions, and Legal Information	12
XTAL Selection Criteria and Application Example	7	Worldwide Sales and Design Support	12
Absolute Maximum Conditions	9	Products	12
Recommended Pullable Crystal Specifications	9	PSoC Solutions	12
Operating Conditions for FailSafe Devices	9		

Pin Configuration

Figure 1. 16-Pin TSSOP

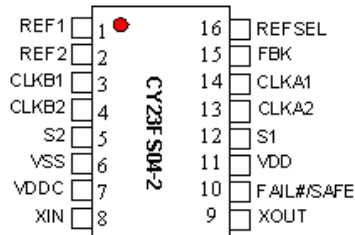

Table 1. Pin Definition

Pin No.	Pin Name	Description
1,2	REF[1:2]	Reference clock inputs. 5V-tolerant. ^[4]
3,4	CLKB[1:2]	Bank B clock outputs. ^[1,2]
14,13	CLKA[1:2]	Bank A clock outputs. ^[1,2]
15	FBK	Feedback input to the PLL. ^[1,4]
12,5	S[1:2]	Frequency select pins and PLL and DCXO bypass mode. ^[3]
8	XIN	Reference crystal input.
9	XOUT	Reference crystal output.
10	FAIL#/SAFE	Valid reference indicator. A high level indicates a valid reference input.
11	VDD	2.5V or 3.3V power supply.
7	VDDC	3.3V power supply.
6	VSS	Ground.
16	REFSEL	Reference select. Selects the active reference clock from either REF1 or REF2. REFSEL = 1, REF1 is selected; REFSEL = 0, REF2 is selected.

Table 2. Configuration Table

S[2:1]	XTAL (MHz)		REF (MHz)		OUT (MHz)		REF:OUT Ratio	REF:XTAL Ratio	Out:XTAL Ratio
	Min	Max	Min	Max	Min	Max			
00			PLL and DCXO Bypass Mode						
01	8.33	30.00	4.17	15.00	4.17	15.00	x1	1/2	1/2
10	8.00	25.00	16.00	50.00	16.00	50.00	x1	2	2
11	8.33	30.00	8.33	30.00	8.33	30.00	x1	1	1

Notes

1. For normal operation, connect either one of the four clock outputs to the FBK input.
2. Weak pull downs on all outputs.
3. Weak pull ups on these inputs.
4. Weak pull down on these inputs

FailSafe Function

The CY23FS04-2 is targeted at clock distribution applications that require continued operation should the main reference clock fail. Existing approaches to this requirement have used multiple reference clocks with either internal or external methods to switch between references. The problem with this technique is that it leads to interruptions (or glitches) when transitioning from one reference to another, often requiring complex external circuitry or software to maintain system stability. The technique implemented in this design completely eliminates any switching of references to the PLL, greatly simplifying system design.

The CY23FS04-2 PLL is driven by the crystal oscillator, which is phase-aligned to an external reference clock so that the output of the device is effectively phase-aligned to the reference via the external feedback loop. This is accomplished by using a digitally controlled capacitor array to pull the crystal frequency over an approximate range of ± 300 ppm from its nominal frequency.

In this mode, if the reference frequency fails (stop or disappear), the DCXO maintains its last setting and a flag signal (FAIL#/SAFE) is set to indicate failure of the reference clock.

The CY23FS04-2 provides two select bits, S1 and S2, to control the reference-to-crystal frequency ratio. The DCXO is internally tuned to the phase and frequency of the external reference only when the reference frequency divided by this ratio is within the DCXO capture range. If the frequency is out of range, a flag is set on the FAIL#/SAFE pin notifying the system that the selected reference is not valid. If the reference moves in range, then the flag is cleared, indicating to the system that the selected reference is valid.

Figure 2. Fail#/Safe Timing for Input Reference Failing Catastrophically

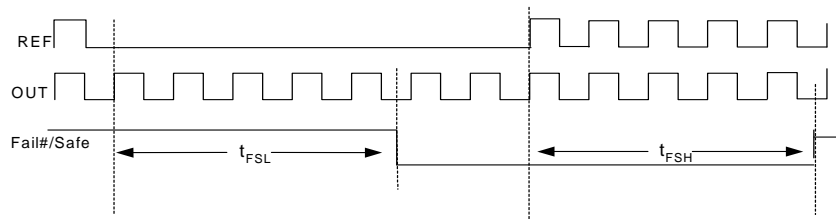

Figure 3. Fail#/Safe Timing Formula

$$t_{FSL(max)} = 2 (t_{REF} \times n) + 25 ns$$

$$n = \frac{F_{REF}}{F_{XTAL}} = 4 \text{ (in above example)}$$

$$t_{FSH(min)} = 12 (t_{REF} \times n) + 25 ns$$

Table 3. FailSafe Timing Table

Parameter	Description	Conditions	Min	Max	Unit
t _{FSL}	Fail#/Safe Assert Delay	Measured at 80% to 20%, Load = 15 pF		See Figure 3	ns
t _{FSH}	Fail#/Safe Deassert Delay	Measured at 80% to 20%, Load = 15 pF	See Figure 3		ns

Figure 4. FailSafe Timing Diagram: Input Reference Slowly Drifting Out of FailSafe Capture Range

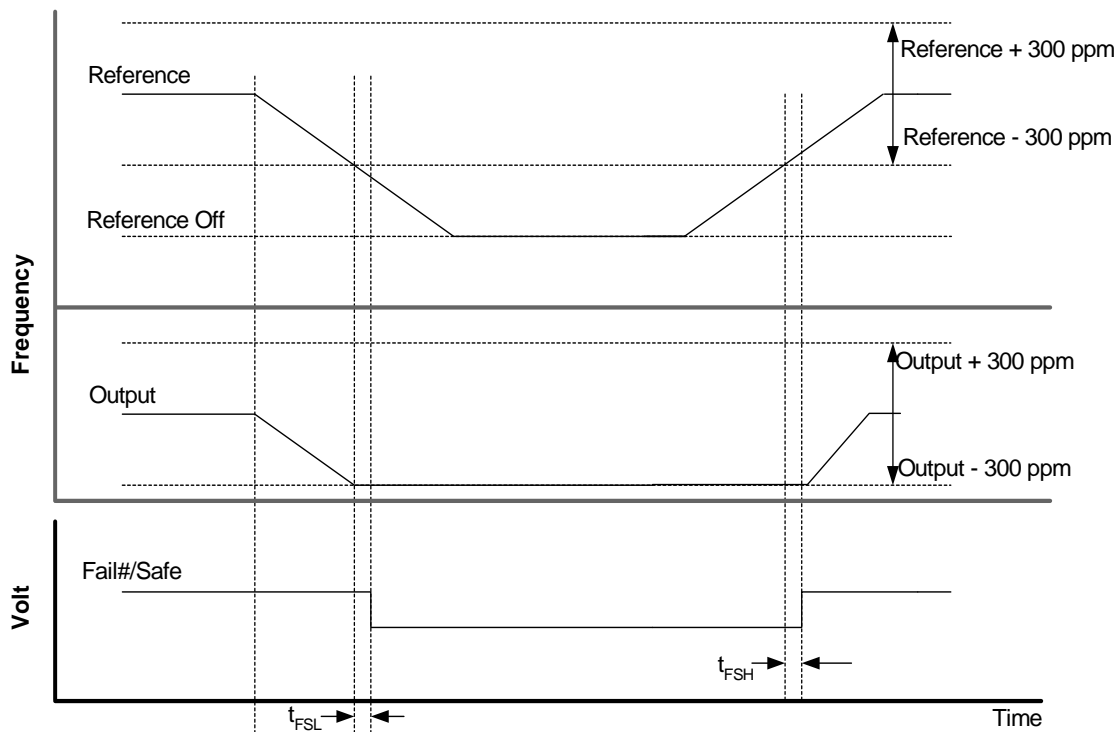
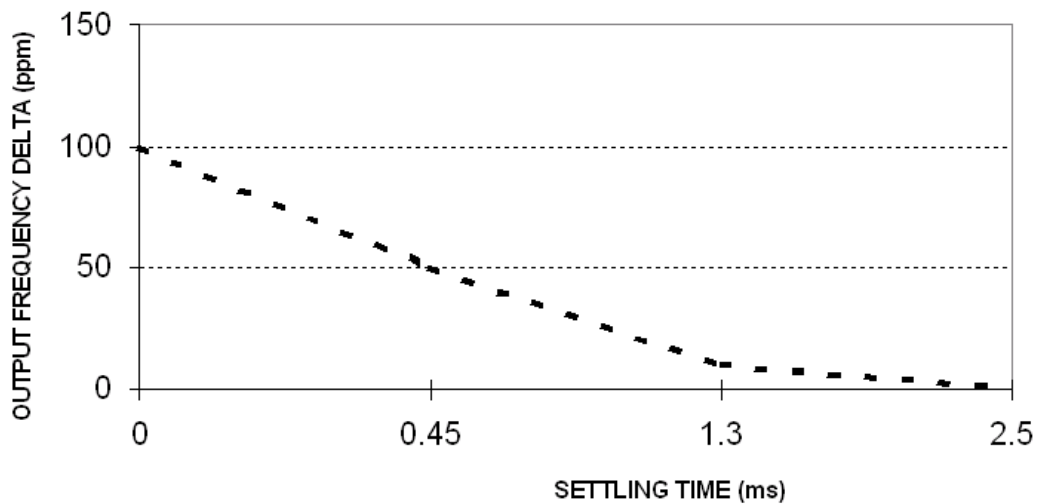

Figure 5. FailSafe Reference Switching Behavior

FailSafe typical frequency settling time

Initial valid Ref1=20MHz +100ppm,
then switching to REF2=20MHz



Because of the DCXO architecture, the CY23FS04-2 has a much lower bandwidth than a typical PLL-based clock generator. This is shown in Figure 6. This low bandwidth makes the CY23FS04-2 also useful as a jitter attenuator. The loop bandwidth curve is also known as the jitter transfer curve.

Figure 6. FailSafe Effective Loop Bandwidth (min)

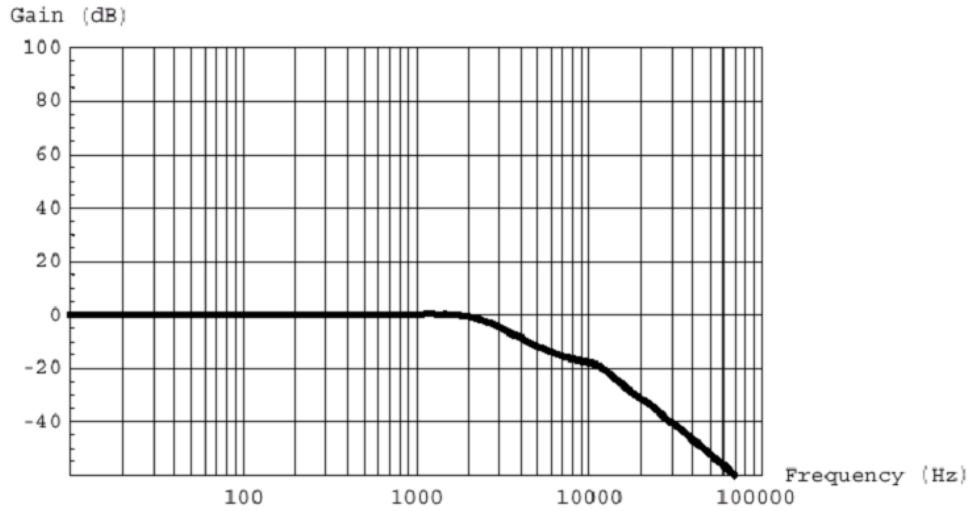

Figure 7. Duty Cycle

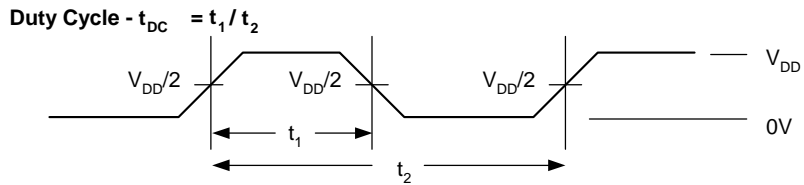

Figure 8. Input Slew Rate

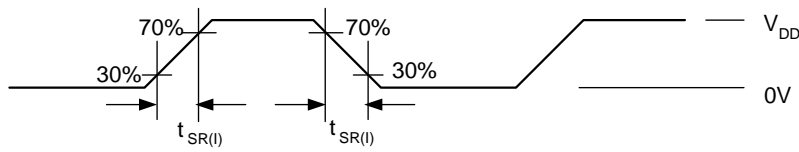

Figure 9. Output Slew Rate

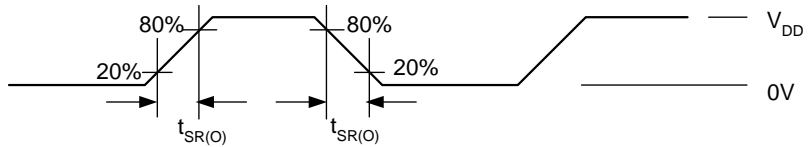

Figure 10. Output to Output Skew and Intrabank Skew

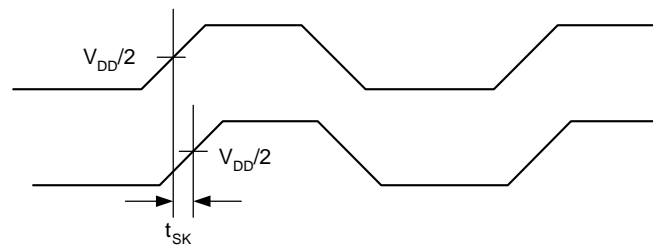

Figure 11. Part to Part Skew

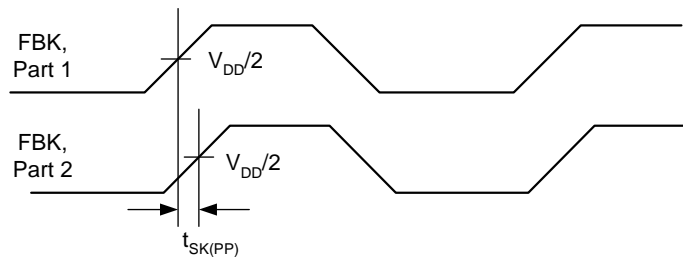
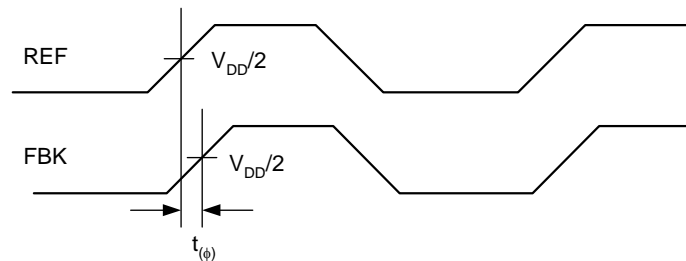

Figure 12. Phase Offset



XTAL Selection Criteria and Application Example

Choosing the appropriate XTAL ensures the FailSafe device is able to span an appropriate frequency of operation. Also, the XTAL parameters determine the holdover frequency stability. Critical parameters are given here. Cypress recommends that you choose:

- Low C0/C1 ratio (240 or less) so that the XTAL has enough range of pullability
- Low temperature frequency variation
- Low manufacturing frequency tolerance
- Low aging

Example:

$$C_{LOADMIN} = (12 \text{ pF IC input cap} + 0 \text{ pF pulling cap} + 6 \text{ pF trace cap on board}) / 2 = 9 \text{ pF}$$

$$C_{LOADMAX} = (12 \text{ pF IC input cap} + 48 \text{ pF pulling cap} + 6 \text{ pF trace cap on board}) / 2 = 33 \text{ pF}$$

$$\text{Pull Range} = (f_{C_{LOADMIN}} - f_{C_{LOADMAX}}) / f_{C_{LOADMIN}} = (C1 / 2) * [(1 / (C0 + C_{LOADMIN})) - (1 / (C0 + C_{LOADMAX}))]$$

$$\text{Pull Range in ppm} = (C1 / 2) * [(1 / (C0 + C_{LOADMIN})) - (1 / (C0 + C_{LOADMAX}))] * 10^6$$

C0 is the XTAL shunt capacitance (3 pF to 7 pF typ).

C1 is the XTAL motional capacitance (10 fF to 30 fF typ).

The capacitive load as “seen” by the XTAL is across its terminals. It is named C_{LOADMIN} (for minimum value), and C_{LOADMAX} (for maximum value). These are used to calculate the pull range.

Note that the C_{LOAD} range “center” is approximately 20 pF, but you may not want a XTAL calibrated to that load. This is because the pullability is not linear, as represented in the equation above. Plotting the pullability of the XTAL shows this expected behavior as shown in Figure 13. In this example, specifying a XTAL calibrated to 14 pF load provides a balanced ppm pullability range around the nominal frequency.

Figure 13. Frequency vs. C_{LOAD} Behavior for Example XTAL

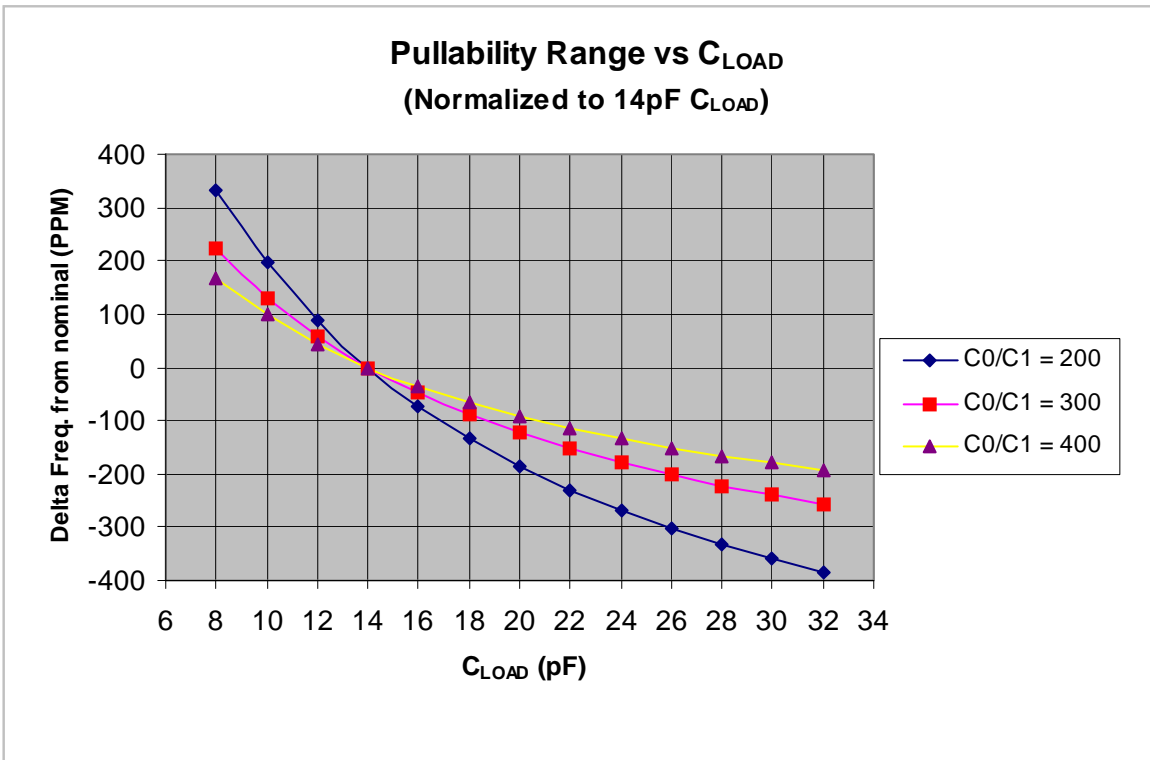

Table 4. Pullability Range of XTAL with Different C0/C1 Ratio

C0/C1 Ratio	C _{LOAD} (min)	C _{LOAD} (max)	Pullability Range	
200	8.0	32.0	-385	333
300	8.0	32.0	-256	222
400	8.0	32.0	-192	166

Calculated value of the pullability range for the XTAL with C0/C1 ratio of 200, 300, and 400 are shown in Table 4. For this calculation C_{LOAD}(min) = 8 pF and C_{LOAD}(max)= 32 pF is used. Using a XTAL that has a nominal frequency specified at load capacitance of 14 pF, almost symmetrical pullability range is obtained.

Next, it is important to calculate the pullability range including error tolerances. This is the capture range of the input reference frequency that the FailSafe device and XTAL combination can reliably span.

Calculating the capture range involves subtracting error tolerances as follows:

- Parameter.....f error (ppm)
- Manufacturing frequency tolerance15
- Temperature stability30
- Aging 3
- Board/trace variation 5
- Total53

Example: Capture Range for XTAL with C0/C1 Ratio of 200

Negative Capture Range= -385 ppm + 53 ppm = -332 ppm

Positive Capture Range = 333 ppm - 53 ppm = +280 ppm

It is important to note that the XTAL with lower C0/C1 ratio has wider pullability/capture range as compared to the higher C0/C1 ratio. This helps to select the appropriate XTAL for use in the FailSafe application.

Absolute Maximum Conditions

Exceeding maximum ratings may shorten the useful life of the device. User guidelines are not tested.

Parameter	Description	Condition	Min	Max	Unit
V _{DD}	Supply Voltage		-0.5	4.6	V
V _{IN}	Input Voltage	Relative to V _{SS}	-0.5	V _{DD} +0.5	VDC
T _S	Temperature, Storage	Non Functional	-65	150	°C
T _J	Temperature, Junction	Functional	-	125	°C
ESD _{HBM}	ESD Protection (Human Body Model)	MIL-STD-883, Method 3015	2000	-	V
∅ _{JC}	Dissipation, Junction to Case	Mil-Spec 883E Method 1012.1	29.87		°C/W
∅ _{JA}	Dissipation, Junction to Ambient	JEDEC (JESD 51)	120.11		°C/W
UL-94	Flammability Rating	At 1/8 in.	V-0		
MSL	Moisture Sensitivity Level		1		

Multiple Supplies: The voltage on any input or I/O pin cannot exceed the power pin during power up. Power supply sequencing is NOT required.

Recommended Pullable Crystal Specifications^[5]

Parameter	Name	Comments	Min	Typ	Max	Unit
F _{NOM}	Nominal crystal frequency	Parallel resonance, fundamental mode, AT cut	8.00	-	30.00	MHz
C _{LOADNOM}	Nominal load capacitance		-	14	-	pF
R ₁	Equivalent series resistance (ESR)	Fundamental mode	-	-	25	Ω
R ₃ /R ₁	Ratio of third overtone mode ESR to fundamental mode ESR	Ratio used because typical R ₁ values are much less than the maximum spec	3	-	-	
DL	Crystal drive level	No external series resistor assumed	-	0.5	2	mW
F _{3SEPLI}	Third overtone separation from 3*F _{NOM}	High side	300	-	-	ppm
F _{3SEPLO}	Third overtone separation from 3*F _{NOM}	Low side	-	-	-150	ppm
C ₀	Crystal shunt capacitance		-	-	7	pF
C ₀ / C ₁	Ratio of shunt to motional capacitance		180	-	250	
C ₁	Crystal motional capacitance		14.4	18	21.6	fF

Operating Conditions for FailSafe Devices

Parameter	Description	Min	Max	Unit
V _{DDC}	3.3V Supply Voltage	3.135	3.465	V
V _{DD}	2.5V Supply Voltage Range	2.375	2.625	V
	3.3V Supply Voltage Range	3.135	3.465	V
T _A	Ambient Operating Temperature, Commercial	0	70	°C
C _L	Output Load Capacitance	-	30	pF
C _{IN}	Input Capacitance (except XIN)	-	7	pF
C _{XIN}	Crystal Input Capacitance (all internal caps off)	10	13	pF
T _{PU}	Power up time for all VDDs to reach minimum specified voltage (power ramps must be monotonic)	0.05	500	ms

Note

5. Ecliptek ECX-5788-13.500M, ECX-5807-19.440M, ECX-5872-19.53125M, ECX-6362-18.432M, ECX-5808-27.000M, ECX-5884-17.664M, ECX-5883-16.384M, ECX-5882-19.200M, ECX-5880-24.576M meet these specifications.

Electrical Characteristics for FailSafe Devices

Parameter	Description	Test Conditions	Min	Typ	Max	Unit
V_{IL}	Input Low Voltage	CMOS Levels, 30% of V_{DD}	–	–	$0.3 \times V_{DD}$	V
V_{IH}	Input High Voltage	CMOS Levels, 70% of V_{DD}	$0.7 \times V_{DD}$	–	–	V
I_{IL}	Input Low Current	$V_{IN} = V_{SS}$ (100k pull up only)	–	–	50	μA
I_{IH}	Input High Current	$V_{IN} = V_{DD}$ (100k pull down only)	–	–	50	μA
I_{OL}	Output Low Current	$V_{OL} = 0.5V, V_{DD} = 2.5V$	–	18	–	mA
		$V_{OL} = 0.5V, V_{DD} = 3.3V$	–	20	–	mA
I_{OH}	Output High Current	$V_{OH} = V_{DD} - 0.5V, V_{DD} = 2.5V$	–	18	–	mA
		$V_{OH} = V_{DD} - 0.5V, V_{DD} = 3.3V$	–	20	–	mA
I_{DDQ}	Quiescent Current	All inputs grounded, PLL and DCXO in bypass mode, Reference Input = 0	–	–	250	μA

Switching Characteristics for FailSafe Devices

Parameter ^[7]	Description	Test Conditions	Min	Max	Unit
f_{REF}	Reference Frequency	Commercial/Industrial Grades	4.17	50	MHz
f_{OUT}	Output Frequency	30 pF Load, Commercial Grade	4.17	50	MHz
f_{XIN}	DCXO Frequency		8.0	30	MHz
t_{DC}	Duty Cycle	Measured at $V_{DD}/2$	47	53	%
$t_{SR(I)}$	Input Slew Rate	Measured on REF1 Input, 30% to 70% of V_{DD}	0.5	4.0	V/ns
$t_{SR(O)}$	Output Slew Rate	Measured from 20% to 80% of $V_{DD} = 3.3V, 15 pF$ Load	0.8	4.0	V/ns
		Measured from 20% to 80% of $V_{DD} = 2.5V, 15 pF$ Load	0.4	3.0	V/ns
$t_{SK(O)}$	Output to Output Skew	All outputs equally loaded, measured at $V_{DD}/2$	–	200	ps
$t_{SK(PP)}$	Part to Part Skew	Measured at $V_{DD}/2$	–	500	ps
$t_{(\phi)}$ ^[6]	Static Phase Offset	Measured at $V_{DD}/2$	–	250	ps
$t_{D(\phi)}$ ^[6]	Dynamic Phase Offset	Measured at $V_{DD}/2$	–	200	ps
$t_{J(CC)}$	Cycle-to-Cycle Jitter	Load = 15 pF, $f_{OUT} \geq 6.25$ MHz	–	200	ps
			–	35	ps _{RMS}

Ordering Information

Part Number	Package Type	Product Flow
Pb-free		
CY23FS04ZXC-2	16-Pin TSSOP	Commercial, 0°C to 70°C
CY23FS04ZXC-2T	16-Pin TSSOP – Tape and Reel	Commercial, 0°C to 70°C

Notes

- The $t_{(\phi)}$ reference feedback input delay is guaranteed for a maximum 4:1 input edge ratio between the two signals as long as $t_{SR(I)}$ is maintained.
- Parameters guaranteed by design and characterization, not 100% tested in production.

Package Diagram

Figure 14. 16-Pin TSSOP 4.40 mm Body

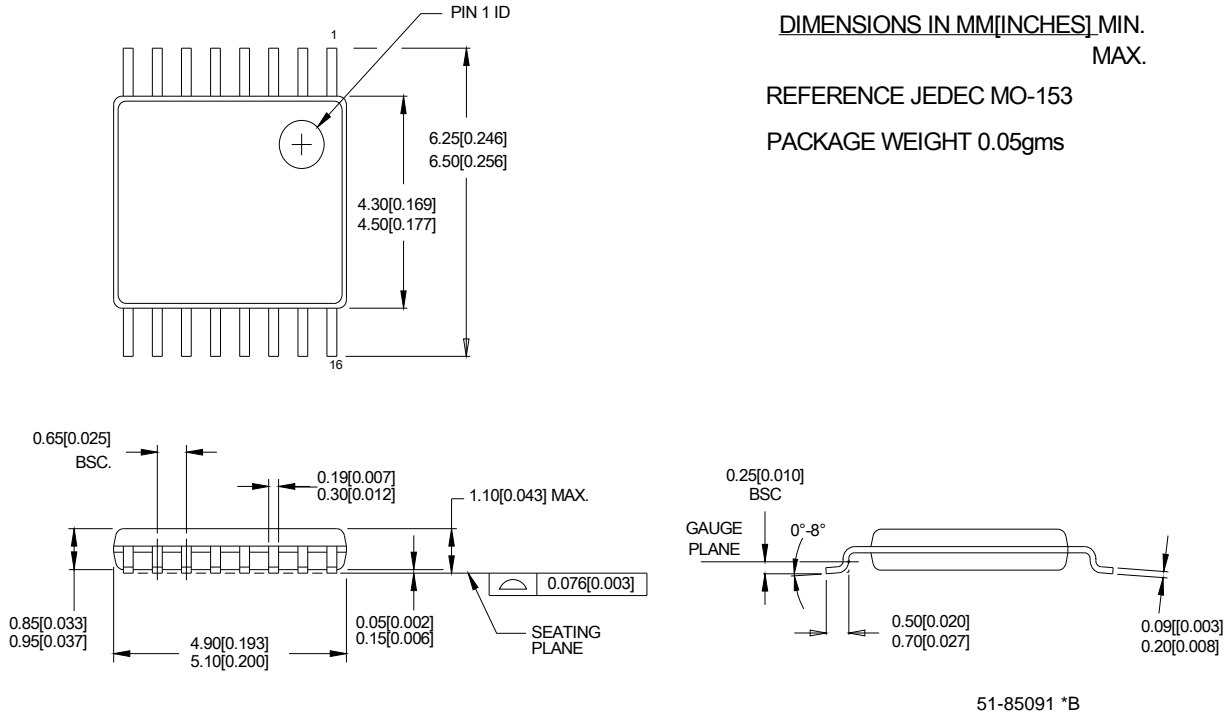

Document History Page

Document Title: CY23FS04-2 Failsafe™ 2.5V/3.3V Zero Delay Buffer Document Number: 38-07671				
Rev.	ECN No.	Submission Date	Orig. of Change	Description of Change
**	224423	See ECN	RGL	New data sheet
*A	276753	See ECN	RGL/ZJX	Removed (T _{LOCK}) Lock Time Specification
*B	2865337	01/25/2010	CXQ	Updated format. Added "Contents" section on page 2. Removed previous Figures 5 and 6. Added / separated Figures 7 through 12. Changed references of "CI" to "C _{LOAD} ". Removed extra T _A reference in Absolute Maximum Conditions. Removed industrial temperature range from T _A . Removed C _L spec for f _{OUT} > 100 MHz (f _{OUT} max is 50 MHz for -2 devices). Changed table captions for Tables 4, 5, and 6 to section headings. Removed note 5 regarding programming cap array. Replaced crystal ECX-5806-18.432M with ECX-6362-18.432M in Note 6. Changed test condition from 15 pF to 30 pF for f _{OUT} spec. Removed industrial temp range devices from Ordering Information. Removed unreferenced Note 9. Updated package drawing specification to rev *B.

Sales, Solutions, and Legal Information

Worldwide Sales and Design Support

Cypress maintains a worldwide network of offices, solution centers, manufacturer's representatives, and distributors. To find the office closest to you, visit us at [Cypress Locations](#).

Products

Automotive	cypress.com/go/automotive	PSoC	cypress.com/go/psoc
Clocks & Buffers	cypress.com/go/clocks	Touch Sensing	cypress.com/go/touch
Interface	cypress.com/go/interface	USB Controllers	cypress.com/go/USB
Lighting & Power Control	cypress.com/go/powerpsoc	Wireless/RF	cypress.com/go/wireless
	cypress.com/go/plc		
Memory	cypress.com/go/memory		
Optical & Image Sensing	cypress.com/go/image		

PSoC Solutions

psoc.cypress.com/solutions

PSoC 1 | PSoC 3 | PSoC 5

© Cypress Semiconductor Corporation, 2003-2010. The information contained herein is subject to change without notice. Cypress Semiconductor Corporation assumes no responsibility for the use of any circuitry other than circuitry embodied in a Cypress product. Nor does it convey or imply any license under patent or other rights. Cypress products are not warranted nor intended to be used for medical, life support, life saving, critical control or safety applications, unless pursuant to an express written agreement with Cypress. Furthermore, Cypress does not authorize its products for use as critical components in life-support systems where a malfunction or failure may reasonably be expected to result in significant injury to the user. The inclusion of Cypress products in life-support systems application implies that the manufacturer assumes all risk of such use and in doing so indemnifies Cypress against all charges.



Any Source Code (software and/or firmware) is owned by Cypress Semiconductor Corporation (Cypress) and is protected by and subject to worldwide patent protection (United States and foreign), United States copyright laws and international treaty provisions. Cypress hereby grants to licensee a personal, non-exclusive, non-transferable license to copy, use, modify, create derivative works of, and compile the Cypress Source Code and derivative works for the sole purpose of creating custom software and/or firmware in support of licensee product to be used only in conjunction with a Cypress integrated circuit as specified in the applicable agreement. Any reproduction, modification, translation, compilation, or representation of this Source Code except as specified above is prohibited without the express written permission of Cypress.

Disclaimer: CYPRESS MAKES NO WARRANTY OF ANY KIND, EXPRESS OR IMPLIED, WITH REGARD TO THIS MATERIAL, INCLUDING, BUT NOT LIMITED TO, THE IMPLIED WARRANTIES OF MERCHANTABILITY AND FITNESS FOR A PARTICULAR PURPOSE. Cypress reserves the right to make changes without further notice to the materials described herein. Cypress does not assume any liability arising out of the application or use of any product or circuit described herein. Cypress does not authorize its products for use as critical components in life-support systems where a malfunction or failure may reasonably be expected to result in significant injury to the user. The inclusion of Cypress' product in a life-support systems application implies that the manufacturer assumes all risk of such use and in doing so indemnifies Cypress against all charges.

Use may be limited by and subject to the applicable Cypress software license agreement.

Looking for pricing, stock, or lifecycle information?

Click below to explore more details on WIN SOURCE:

-  [View CY23FS04ZXC-2T on WIN SOURCE](#)
-  [Cypress Semiconductor Corp Information](#)

Optimize Your Supply Chain with WIN SOURCE Solutions

-  Global Sourcing Solution
-  Obsolete Management
-  Cost Control Management
-  Shortage Management
-  Alternative Solution
-  Excess Inventory Management