



**THE DATASHEET OF
D4S20G-400A5-A**



Technical Data Sheet

Rosenberger

Rosenberger
HSD®

RIGHT ANGLE PLUG
FOR PCB

D4S20G-400A5-Y

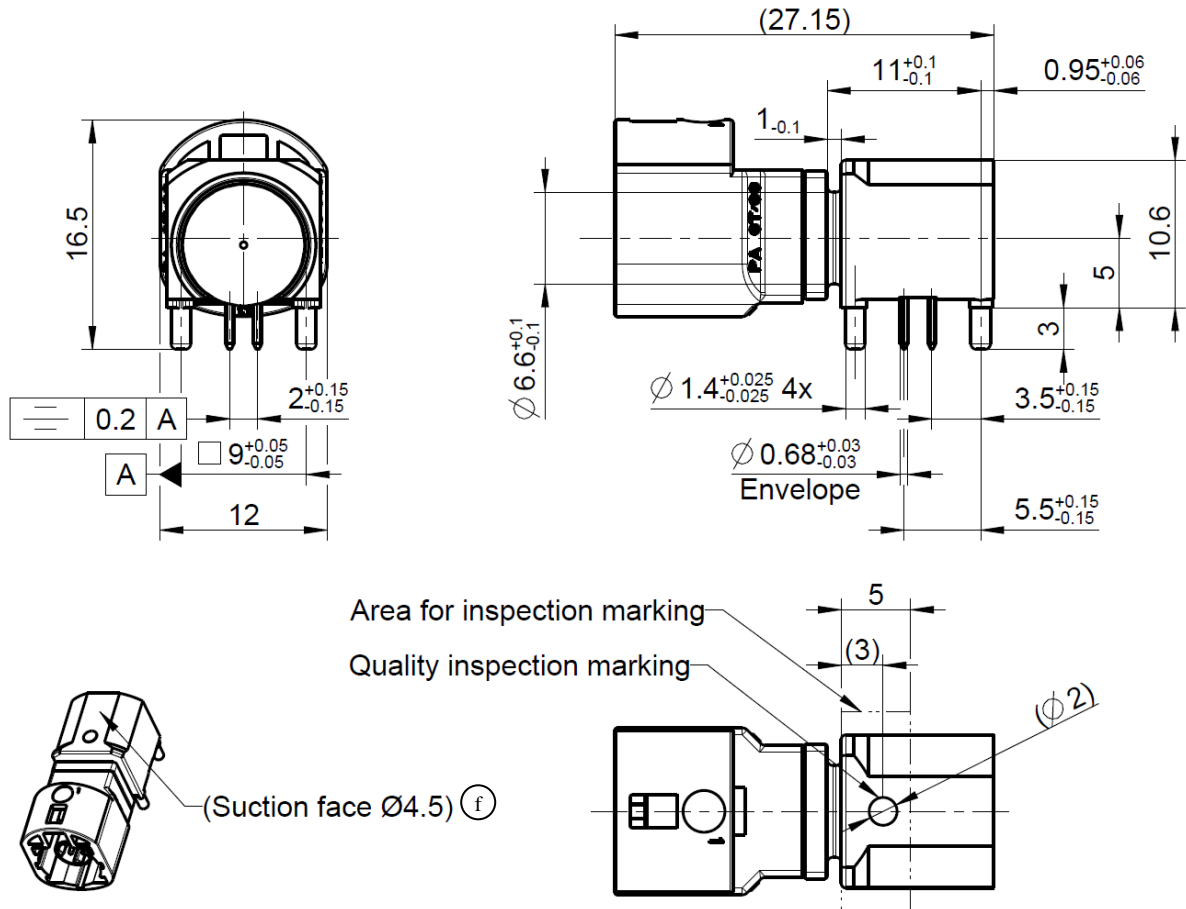

All dimensions are in mm; tolerances according to ISO 2768 m-H

EMC-screening must be assured by chassis compartment. Control box manufacturer is responsible for EMC-screening.

Interface

According to RN_059-01

Documents

Assembly instruction	D4V013
Panel piercing	MB_261
Pinning instruction	RN_053-01
Test specification	RN_061-01

Material and plating

Connector parts

Center contact

Outer contact (Interface)

Outer contact (PCB)

Cover

Dielectric

Housing

Material

Spring bronze

Brass

Zinc Alloy

Alpaca

LCP

PA 6T/66

Plating

Gold, 0.15 µm (Interface)

Tin, 0.5-2 µm (PCB)

Nickel, 3-6 µm

Tin, 2-5 µm, over nickel 1-5 µm

Electrical data

Impedance, differential mode

100 Ω differential signalling, for one pair or quad cable shielded

Frequency

DC to 2.0 GHz

Return loss

≥ 20 dB, DC to ≤ 1 GHz
≥ 17 dB, > 1 GHz to ≤ 2 GHz

Insertion loss

≤ 0.1 dB @ 1.0 GHz

Skew (between signal contacts)

≤ 5 psec

Nearend-Crosstalk

≤ 30 dB

Farend-Crosstalk

≤ 35 dB

Insulation resistance

≥ 1x10³ MΩ

Signal contact resistance

≤ 10 mΩ

Outer contact resistance

≤ 7.5 mΩ

Test voltage

250 V rms

Working voltage

100 V rms

Power current

≤ 1.5 A DC

RF-leakage (shielding effectiveness)

≥ 75 dB up to 1 GHz (IEC 62153-4-7)
≥ 65 dB up to 2 GHz (IEC 62153-4-7)

Mechanical data

Mating cycles

≥ 25

Engagement force

≤ 30 N

Disengagement force

≥ 5 N

Retention force latch

≥ 110 N

Coding efficiency

≥ 80 N

Environmental data

Temperature range

-40°C to +105°C

Thermal shock

DIN IEC 60068-2-14 Test NA

Temperature and humidity

USCar 2 – 4 5.6.2

Vibration (Random)

DIN IEC 60068-2-64

Mechanical shock

DIN IEC 60068-2-27

High-Temp. Exposure

DIN IEC 60068-2-2

Soldering profile

acc. to IEC 60068-2-58; Group 3&4

RoHS

compliant

Packing

Standard

175 pcs in tape & reel







1050 pcs (175 pcs in tape & reel, 6 reels in box) g

Weight

8.6 g

Coding

Part number has to be accomplished by codification

Coding	Plug	Colour	RAL	Part-Number
A		black	sim. 9005	D4S20G-400A5-A
B		white	sim. 9001	D4S20G-400A5-B
C		blue	sim. 5005	D4S20G-400A5-C
D		bordeaux	sim. 4004	D4S20G-400A5-D
E		green	sim. 6002	D4S20G-400A5-E
F		brown	sim. 8011	D4S20G-400A5-F
Z		waterblue	sim. 5021	D4S20G-400A5-Z

Coding for special use

Part number has to be accomplished by codification

Control box manufacturer is responsible for pinning

Coding	Plug	Colour	RAL	Part-Number
G		grey	sim. 7031	D4S20G-400A5-G
H		violet	sim. 4003	D4S20G-400A5-H
J		beige	sim. 1001	D4S20G-400A5-J
O		light green	sim. 6027	D4S20G-400A5-O

h

Change History

Rev.	Date	Change
f00	09.05.16	Note "Suction face Ø4.5" changed to "(Suction face Ø4.5)"
g00	02.06.16	Bundle size changed from "1200 pcs in box (6 X 200 pcs in blister tray)" To "1050 pcs in box (6 x 175 pcs/reel)"
h00	07.12.20	Coding J added

Dieses Dokument ist urheberrechtlich geschützt • This document is protected by copyright • Rosenberger Hochfrequenztechnik GmbH & Co. KG

While the information has been carefully compiled to the best of our knowledge, nothing is intended as representation or warranty on our part and no statement herein shall be construed as recommendation to infringe existing patents. In the effort to improve our products, we reserve the right to make changes judged to be necessary.



Draft	Date	Approved	Date	Rev.	Engineering change number	Name	Date
R. Bippus	11.06.07	T. Georg	07.12.20	h00	20-2333	M. Jacobs	07.12.20

Rosenberger Hochfrequenztechnik GmbH & Co. KG P.O.Box 1260 D-84526 Tittmoning Germany www.rosenberger.de	Tel. : +49 8684 18-0 Email : info@rosenberger.de	Page 4 / 4
--	--	---------------

RF_35/09_14/6.2

Looking for pricing, stock, or lifecycle information?

Click below to explore more details on WIN SOURCE:

-  [View D4S20G-400A5-A on WIN SOURCE](#)
-  [Rosenberger Information](#)

Optimize Your Supply Chain with WIN SOURCE Solutions

-  Global Sourcing Solution
-  Obsolete Management
-  Cost Control Management
-  Shortage Management
-  Alternative Solution
-  Excess Inventory Management