



**THE DATASHEET OF
F380J226MMA**



F38 Series

Conductive Polymer, Miniature, Undertab Solid Electrolytic Chip Capacitors

FEATURES

- Conductive Polymer Electrode
- Benign Failure Mode Under Recommended Use Conditions
- Compliant to the RoHS3 directive 2015/863/EU
- SMD Facedown
- Small and Low Profile
- High Volumetric Efficiency
- 100% Surge Current Tested

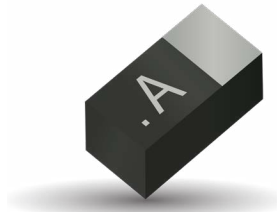

APPLICATIONS

- Smartphone
- Tablet PC
- Wireless Module
- Portable Game
- Bulk Decoupling of SoC (System on Chip)

CASE DIMENSIONS: millimeters (inches)

Code	Special Code	EIA Code	EIA Metric	L	W ₁	W ₂	H	S ₁	S ₂
M		0603	1608-09	1.60 ^{+0.20} _{-0.10} (0.063 ^{+0.008} _{-0.004})	0.85 ^{+0.20} _{-0.10} (0.033 ^{+0.008} _{-0.004})	0.65±0.10 (0.026±0.004)	0.80±0.10 (0.031±0.004)	0.50±0.10 (0.020±0.004)	0.60±0.10 (0.024±0.004)
M	AXE	0603	1608-10	1.60 ^{+0.20} _{-0.10} (0.063 ^{+0.008} _{-0.004})	0.85 ^{+0.20} _{-0.10} (0.033 ^{+0.008} _{-0.004})	0.65±0.10 (0.026±0.004)	1.00 Max. (0.039 Max.)	0.50±0.10 (0.020±0.004)	0.60±0.10 (0.024±0.004)
S		0805	2012-09	2.00 ^{+0.20} _{-0.10} (0.079 ^{+0.008} _{-0.004})	1.25 ^{+0.20} _{-0.10} (0.049 ^{+0.008} _{-0.004})	0.90±0.10 (0.035±0.004)	0.80±0.10 (0.031±0.004)	0.50±0.10 (0.020±0.004)	1.00±0.10 (0.039±0.004)
S	H8Z	0805	2012-08	2.00 ^{+0.20} _{-0.10} (0.079 ^{+0.008} _{-0.004})	1.25 ^{+0.20} _{-0.10} (0.049 ^{+0.008} _{-0.004})	0.90±0.10 (0.035±0.004)	0.80 Max. (0.031 Max.)	0.50±0.10 (0.020±0.004)	1.00±0.10 (0.039±0.004)
U		0402	1106-06	1.10±0.05 (0.043±0.002)	0.60±0.05 (0.024±0.002)	0.35±0.05 (0.014±0.002)	0.55±0.05 (0.022±0.002)	0.30±0.05 (0.012±0.002)	0.50±0.05 (0.020±0.002)

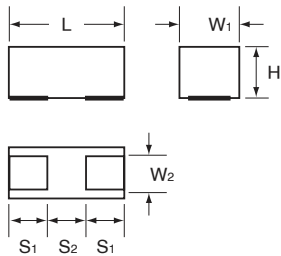

MARKING

U CASE



M CASE



Rated Voltage Code

S CASE

*Capacitance Code



Rated Voltage Code

HOW TO ORDER

F38	1A	225	M	M						
Type	Rated Voltage	Capacitance Code	Tolerance	Case Size	Packaging	Special Code				
		pF code: 1st two digits represent significant figures, 3rd digit represents multiplier (number of zeros to follow)	M=±20%	See table above	<table border="1"> <tr> <td>Reel Dia (φ180)</td> <td>Tape Width (mm)</td> </tr> <tr> <td>A</td> <td>8</td> </tr> </table>	Reel Dia (φ180)	Tape Width (mm)	A	8	AXE = Rated temperature 60°C and H dimension 1.0mm Max. AXEH3 = Rated temperature 60°C and H dimension 1.0mm Max., Low ESR LZT = Rated temperature 60°C LZTH1 = Rated temperature 60°C, Low ESR AH1, AH2, AH3 = Low ESR H8Z = H dimension 0.8mm Max.
Reel Dia (φ180)	Tape Width (mm)									
A	8									

TECHNICAL SPECIFICATIONS

Category Temperature Range:	-55 to +105°C
Rated Range:	+85°C or +60°C (*2)
Capacitance Tolerance:	±20% at 120Hz
Dissipation Factor:	Refer to next page (120Hz)
ESR 100kHz:	Refer to next page (120Hz)
Leaking Current:	Refer to next page At 20°C after application of rated voltage for 5 minutes Provided that: After 5 minute's application of rated voltage, leakage current at 105°C 10 times or less than 20°C specified value.
Termination Finish:	M, S case: Gold Plating (standard), U case: Sn Plating (standard)

*2 LZT and AXE: Rated temperature +60°C, Surge and Endurance test temperature +60°C

F38 Series

Conductive Polymer, Miniature, Undertab Solid Electrolytic Chip Capacitors

CAPACITANCE AND RATED VOLTAGE RANGE (LETTER DENOTES CASE SIZE)

Capacitance µF	Code	Rated Voltage								*Cap Code		
		4V (0G)	6.3V (0J)	8V (0K)	10V (1A)	16V (1C)	25V (1E)	30V (1S)	35V (1V)		38V (1X)	
1.0	105		U								S	A
2.2	225				M			M				J
3.3	335							M		S		N
4.7	475		U		M/S			S/S***	S			S
10	106		M/M(AH1,AH2)/S/U		M/M(AH1)/S	S						a
22	226		M/M(AH3,AH1)/S/S(AH1)		M*4/S							J
33	336		M**/S	S***	S**							n
47	476		M*4/M*4(H3)/S/S(AH1)/S***	S	S**							s
68	686		S**									w
100	107	S**	S**/S**(H1)									A

Released ratings, (Low ESR)

Engineering Samples - Please Contact KYOCERA AVX

*4 (AXE) Rated temperature 60°C and H dimension 1.0mm Max. Please contact KYOCERA AVX when you need detail spec.

** (LZT) Rated temperature 60°C. Please contact KYOCERA AVX when you need detail spec.

*** (H8Z) H dimension 0.8mm Max.

Please contact to your local KYOCERA AVX sales office when these series are being designed in your application.

THE CORRELATIONS AMONG RATED VOLTAGE, SURGE VOLTAGE AND DERATED VOLTAGE

	F38 (Standard)							
Rated Voltage (V) ≤85°C	6.3	8	10	16	25	30	35	38
85°C Surge Voltage (V)	8	10	13	21	32	39	46	49
105°C Derated Voltage (V)	5	6.3	8	13	20	24	28	30

	F38-LZT, F38-AXE		
Rated Voltage (V) ≤60°C	4	6.3	10
60°C Surge Voltage (V)	5.2	8	13
85°C Derated Voltage (V)	2.8	4.5	7.2
105°C Derated Voltage (V)	2	3.3	5

RATINGS & PART NUMBER REFERENCE

Part Number	Case Size	Capacitance (µF)	Rated Voltage (V)	DCL (µA)	DF @ 120Hz (%)	ESR @ 100kHz (mΩ)	100kHz RMS Current (mA)				*3 ΔC/C (%)	MSL
							45°C	60°C	85°C	105°C		
4 Volt												
F380G107MSALZT	S	100	4	80.0	10	200	474	332	-	237	*	3
6.3 Volt												
F380J105MUA	U	1	6.3	0.6	6	1500	100	-	70	50	*	3
F380J475MUA	U	4.7	6.3	20.0	10	1500	100	-	70	50	*	3
F380J106MMA	M	10	6.3	10.0	8	500	224	-	157	112	*	3
F380J106MMAAH1	M	10	6.3	10.0	8	300	289	-	202	144	*	3
F380J106MMAAH2	M	10	6.3	10.0	8	200	354	-	247	177	*	3
F380J106MSA	S	10	6.3	6.3	10	250	424	-	297	212	*	3
F380J106MUA	U	10	6.3	20.0	10	1500	100	-	70	50	*	3
F380J226MMA	M	22	6.3	13.9	10	500	224	-	157	112	*	3
F380J226MMAAH3	M	22	6.3	13.9	10	300	289	-	202	144	*	3
F380J226MMAAH1	M	22	6.3	13.9	10	200	354	-	247	177	*	3
F380J226MSA	S	22	6.3	13.9	10	200	474	-	332	237	*	3
F380J226MSAAH1	S	22	6.3	13.9	10	150	548	-	383	274	*	3
F380J336MMALZT	M	33	6.3	41.6	10	500	224	157	-	112	*	3
F380J336MSA	S	33	6.3	20.8	10	200	474	-	332	237	*	3
F380J476MMAAXE	M	47	6.3	59.2	10	500	224	157	-	112	*	3
F380J476MMAAXEH3	M	47	6.3	59.2	10	300	289	202	-	144	*	3
F380J476MSA	S	47	6.3	29.6	10	200	474	-	332	237	*	3
F380J476MSAAH1	S	47	6.3	29.6	10	150	548	-	383	274	*	3
F380J476MSAH8Z	S	47	6.3	29.6	10	200	474	-	332	237	*	3
F380J686MSALZT	S	68	6.3	86.0	10	200	474	332	-	237	*	3
F380J107MSALZT	S	100	6.3	126.0	10	200	474	332	-	237	*	3
F380J107MSALZTH1	S	100	6.3	126.0	10	150	548	383	-	274	*	3
8 Volt												
F380K336MSAH8Z	S	33	8	26.4	10	200	474	-	332	237	*	3
F380K476MSA	S	47	8	37.6	10	200	474	-	332	237	*	3
10 Volt												
F381A225MMA	M	2.2	10	10.0	6	500	224	-	157	112	*	3
F381A475MMA	M	4.7	10	10.0	6	500	224	-	157	112	*	3
F381A475MSA	S	4.7	10	4.7	10	300	387	-	271	194	*	3
F381A106MMA	M	10	10	10.0	15	500	224	-	157	112	*	3
F381A106MMAAH1	M	10	10	10.0	15	300	289	-	202	144	*	3
F381A106MSA	S	10	10	10.0	6	200	474	-	332	237	*	3
F381A226MMAAXE	M	22	10	44.0	10	500	224	157	-	112	*	3
F381A226MSA	S	22	10	22.0	10	200	474	-	332	237	*	3
F381A336MSALZT	S	33	10	99.0	10	200	474	332	-	237	*	3
F381A476MSALZT	S	47	10	94.0	10	200	474	332	-	237	*	3
16 Volt												
F381C106MSA	S	10	16	16.0	10	500	300	-	210	150	*	3

*3: ΔC/C Marked "**"

Moisture Sensitivity Level (MSL) is defined according to J-STD-020

F38 Series

Conductive Polymer, Miniature, Undertab Solid Electrolytic Chip Capacitors

Part Number	Case Size	Capacitance (µF)	Rated Voltage (V)	DCL (µA)	DF @ 120Hz (%)	ESR @ 100kHz (mΩ)	100kHz RMS Current (mA)				*3 ΔC/C (%)	MSL
							45°C	60°C	85°C	105°C		
25 Volt												
F381E225MMA	M	2.2	25	10.0	10	500	224	-	157	112	*	3
F381E335MMA	M	3.3	25	10.0	10	500	224	-	157	112	*	3
F381E475MSA	S	4.7	25	11.8	10	500	300	-	210	150	*	3
F381E475MSAH8Z	S	4.7	25	11.8	10	500	300	-	210	150	*	3
30 Volt												
F381S475MSA	S	4.7	30	14.1	10	500	300	-	210	150	*	3
35 Volt												
F381V335MSA	S	3.3	35	11.6	10	500	300	-	210	150	*	3
38 Volt												
F381X105MSA	S	1	38	3.8	10	500	300	-	210	150	*	3

3: ΔC/C Marked “”

Moisture Sensitivity Level (MSL) is defined according to J-STD-020

Item	All Case (%)
Damp Heat, steady state	-20 to +30
Rapid change of temperature	±20
Resistance soldering heat	±20
Surge	±20
Endurance	±20

RECOMMENDED DERATING FACTOR

Voltage and temperature derating as percentage of Vr

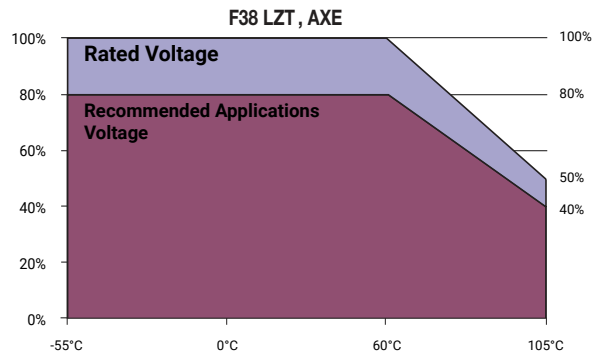
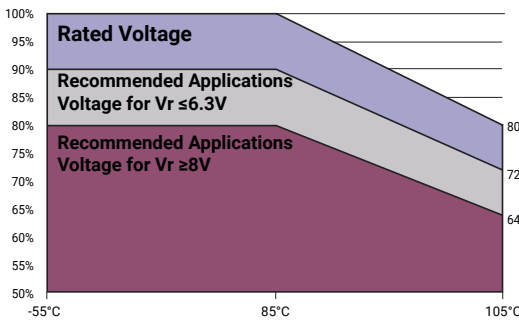

QUALIFICATION TABLE

TEST	F38 series (Temperature Range -55°C to +105°C)	
	Condition	
Damp Heat (Steady State)	At 40°C, 90 to 95% R.H., 500 hours (No voltage applied) Capacitance Change Refer to the table above (*3) Dissipation Factor 200% or less of initial specified value Leakage Current 300% or less of Initial specified value	
Temperature Cycles	At -55°C / +105°C, 30 minutes each, 5 cycles Capacitance Change Refer to the table above (*3) Dissipation Factor 200% or less of initial specified value Leakage Current 400% or less of initial specified value	
Resistance to Soldering Heat	5 seconds reflow at 260°C Capacitance Change Refer to the table above (*3) Dissipation Factor 200% or less of initial specified value Leakage Current 300% or less of initial specified value	
Surge	After application of surge voltage in series with a 1kΩ resistor at the rate of 30 seconds ON, 30 seconds OFF, for 1000 successive test cycles at 85°C or 60°C (*2), capacitors shall meet the characteristic requirements in the table above. Capacitance Change Refer to the table above (*3) Dissipation Factor 200% or less of initial specified value Leakage Current 300% or less of initial specified value	
Endurance	After 1000 hours' application of rated voltage in series with a 3Ω resistor at 85°C or 60°C (*2), capacitors shall meet the characteristic requirements in the table above. Capacitance Change Refer to the table above (*3) Dissipation Factor 200% or less of initial specified value Leakage Current 400% or less of initial specified value	
Shear Test	After applying the pressure load of 5N for 10±1 seconds horizontally to the center of capacitor side body which has no electrode and has been soldered beforehand on a substrate, there shall be found neither exfoliation nor its sign at the terminal electrode.	 5N (0.51kg · f) For 10±1 seconds
Terminal Strength	Keeping a capacitor surface-mounted on a substrate upside down and supporting the substrate at both of the opposite bottom points 45mm apart from the center of capacitor, the pressure strength is applied with a specified jig at the center of substrate so that the substrate may bend by 1mm as illustrated. Then, there shall be found no remarkable abnormality on the capacitor terminals.	 R230 20mm 45mm 45mm 1mm

*2 LZT and AXE: Rated temperature 60°C, Surge and Endurance test temperature 60°C

F38 Series

Conductive Polymer, Miniature, Undertab Solid Electrolytic Chip Capacitors

SOLID ELECTROLYTIC CAPACITOR ROADMAP

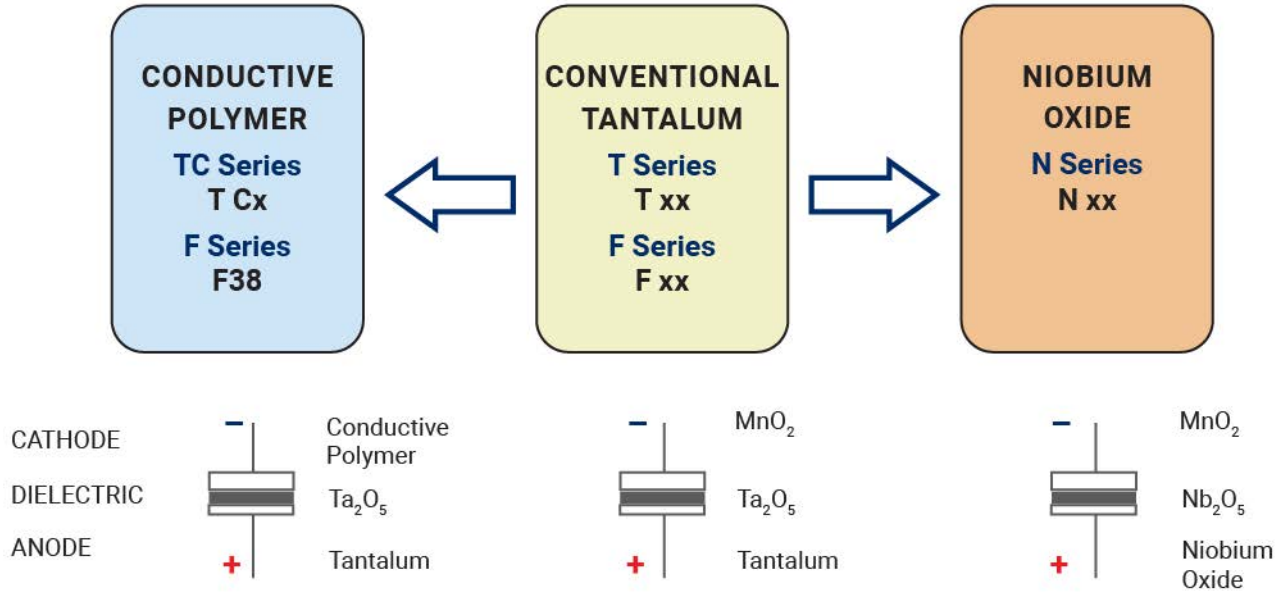

FIVE CAPACITOR CONSTRUCTION STYLES

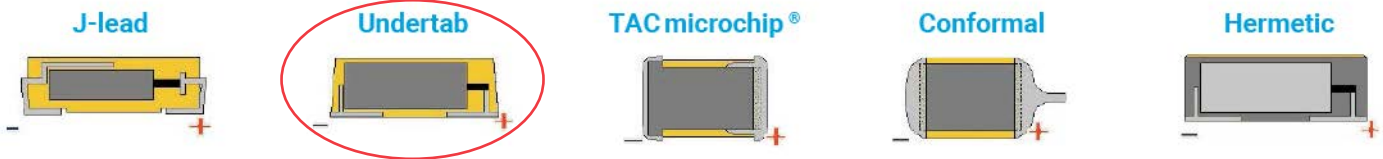

SERIES LINE UP : Conductive Polymer

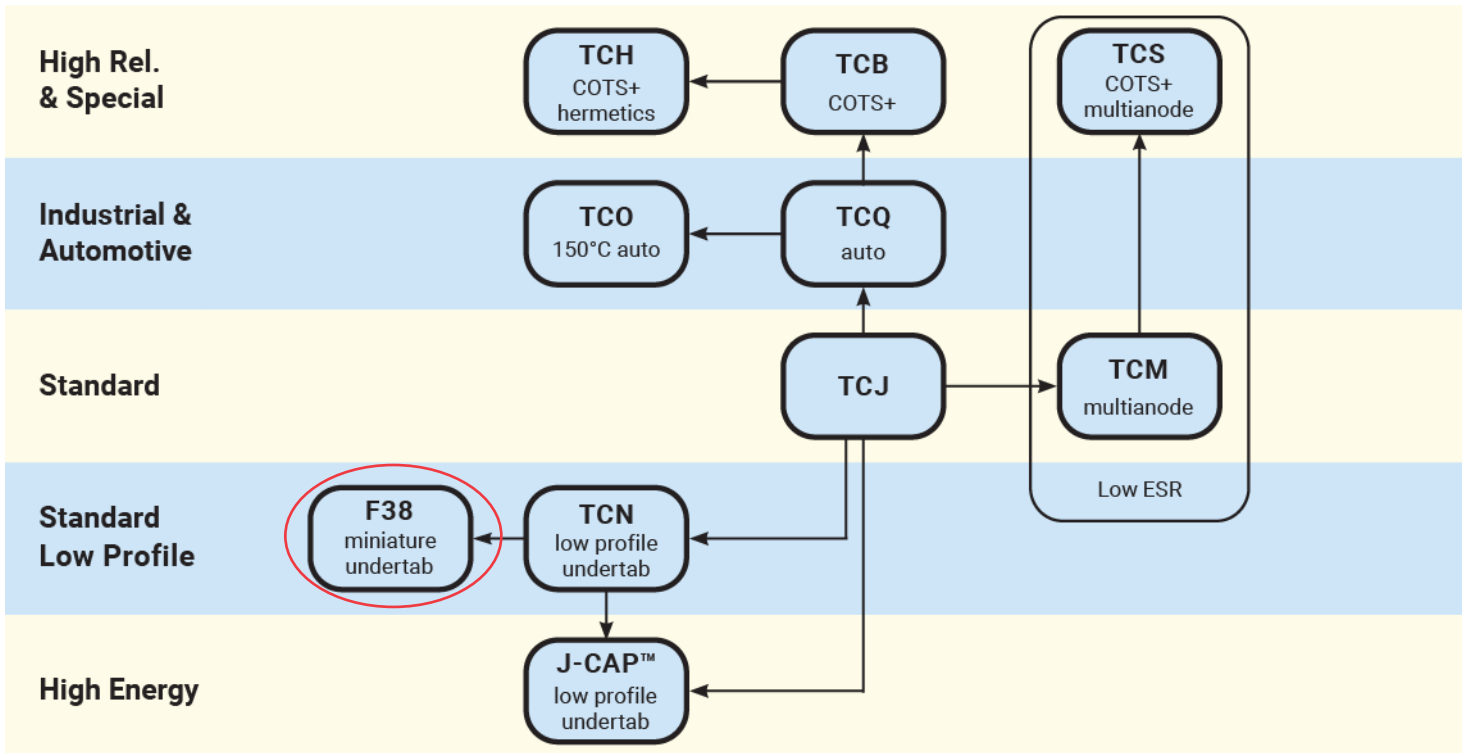

Looking for pricing, stock, or lifecycle information?

Click below to explore more details on WIN SOURCE:

 [View F380J226MMA](#) on WIN SOURCE

 [AVX Corporation](#) Information

Optimize Your Supply Chain with WIN SOURCE Solutions

-  Global Sourcing Solution
-  Obsolete Management
-  Cost Control Management
-  Shortage Management
-  Alternative Solution
-  Excess Inventory Management