



**THE DATASHEET OF  
IPL60R065P7AUMA1**



## MOSFET

### 600V CoolMOS™ P7 Power Transistor

The CoolMOS™ 7th generation platform is a revolutionary technology for high voltage power MOSFETs, designed according to the superjunction (SJ) principle and pioneered by Infineon Technologies. The 600V CoolMOS™ P7 series is the successor to the CoolMOS™ P6 series. It combines the benefits of a fast switching SJ MOSFET with excellent ease of use, e.g. very low ringing tendency, outstanding robustness of body diode against hard commutation and excellent ESD capability. Furthermore, extremely low switching and conduction losses make switching applications even more efficient, more compact and much cooler.

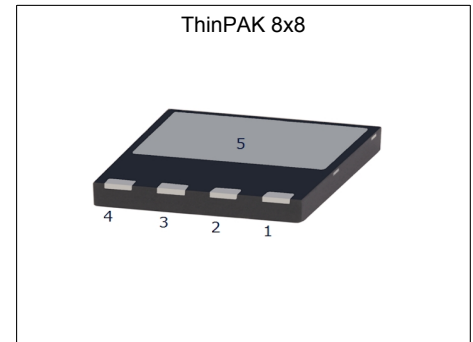

### Features

- Suitable for hard and soft switching (PFC and LLC) due to an outstanding commutation ruggedness
- Significant reduction of switching and conduction losses
- Excellent ESD robustness >2kV (HBM) for all products
- Better  $R_{DS(on)}$ /package products compared to competition enabled by a low  $R_{DS(on)} \cdot A$  (below  $10\text{Ohm} \cdot \text{mm}^2$ )
- Fully qualified acc. JEDEC for Industrial Applications

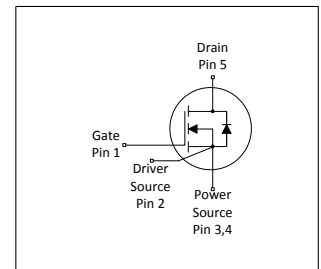

### Benefits

- Ease of use and fast design-in through low ringing tendency and usage across PFC and PWM stages
- Simplified thermal management due to low switching and conduction losses
- Increased power density solutions enabled by using products with smaller footprint and higher manufacturing quality due to >2 kV ESD protection
- Suitable for a wide variety of applications and power ranges



### Potential applications

PFC stages, hard switching PWM stages and resonant switching stages for e.g. PC Silverbox, Adapter, LCD & PDP TV, Lighting, Server, Telecom and UPS.

*Please note: For MOSFET paralleling the use of ferrite beads on the gate or separate totem poles is generally recommended.*

**Table 1 Key Performance Parameters**

Parameter	Value	Unit
$V_{DS} @ T_{j,max}$	650	V
$R_{DS(on),max}$	65	m $\Omega$
$Q_{g,typ}$	67	nC
$I_{D,pulse}$	151	A
$E_{oss} @ 400V$	7.1	$\mu\text{J}$
Body diode $di_f/dt$	800	A/ $\mu\text{s}$

Type / Ordering Code	Package	Marking	Related Links
IPL60R065P7	PG-VSON-4	60R065P7	see Appendix A

## Table of Contents

Description .....	1
Maximum ratings .....	3
Thermal characteristics .....	4
Electrical characteristics .....	5
Electrical characteristics diagrams .....	7
Test Circuits .....	11
Package Outlines .....	12
Appendix A .....	13
Revision History .....	14
Trademarks .....	14
Disclaimer .....	14

## 1 Maximum ratings

at  $T_j = 25^\circ\text{C}$ , unless otherwise specified

**Table 2 Maximum ratings**

Parameter	Symbol	Values			Unit	Note / Test Condition
		Min.	Typ.	Max.		
Continuous drain current <sup>1)</sup>	$I_D$	-	-	41 32	A	$T_C=25^\circ\text{C}$ $T_C=100^\circ\text{C}$
Pulsed drain current <sup>2)</sup>	$I_{D,pulse}$	-	-	151	A	$T_C=25^\circ\text{C}$
Avalanche energy, single pulse	$E_{AS}$	-	-	159	mJ	$I_D=6.4\text{A}$ ; $V_{DD}=50\text{V}$ ; see table 10
Avalanche energy, repetitive	$E_{AR}$	-	-	0.80	mJ	$I_D=6.4\text{A}$ ; $V_{DD}=50\text{V}$ ; see table 10
Avalanche current, single pulse	$I_{AS}$	-	-	6.4	A	-
MOSFET dv/dt ruggedness	dv/dt	-	-	80	V/ns	$V_{DS}=0\dots400\text{V}$
Gate source voltage (static)	$V_{GS}$	-20	-	20	V	static;
Gate source voltage (dynamic)	$V_{GS}$	-30	-	30	V	AC ( $f>1\text{ Hz}$ )
Power dissipation	$P_{tot}$	-	-	201	W	$T_C=25^\circ\text{C}$
Storage temperature	$T_{stg}$	-40	-	150	$^\circ\text{C}$	-
Operating junction temperature	$T_j$	-40	-	150	$^\circ\text{C}$	-
Mounting torque	-	-	-	-	Ncm	-
Continuous diode forward current	$I_S$	-	-	41	A	$T_C=25^\circ\text{C}$
Diode pulse current <sup>2)</sup>	$I_{S,pulse}$	-	-	151	A	$T_C=25^\circ\text{C}$
Reverse diode dv/dt <sup>3)</sup>	dv/dt	-	-	50	V/ns	$V_{DS}=0\dots400\text{V}$ , $I_{SD}\leq 41\text{A}$ , $T_j=25^\circ\text{C}$ see table 8
Maximum diode commutation speed	di <sub>F</sub> /dt	-	-	800	A/ $\mu\text{s}$	$V_{DS}=0\dots400\text{V}$ , $I_{SD}\leq 41\text{A}$ , $T_j=25^\circ\text{C}$ see table 8
Insulation withstand voltage	$V_{ISO}$	-	-	n.a.	V	$V_{rms}$ , $T_C=25^\circ\text{C}$ , $t=1\text{min}$

<sup>1)</sup> Limited by  $T_{j,max}$ . Maximum Duty Cycle  $D = 0.50$

<sup>2)</sup> Pulse width  $t_p$  limited by  $T_{j,max}$

<sup>3)</sup> Identical low side and high side switch with identical  $R_\theta$

## 2 Thermal characteristics

**Table 3 Thermal characteristics**

Parameter	Symbol	Values			Unit	Note / Test Condition
		Min.	Typ.	Max.		
Thermal resistance, junction - case	$R_{thJC}$	-	-	0.62	°C/W	-
Thermal resistance, junction - ambient	$R_{thJA}$	-	-	62	°C/W	device on PCB, minimal footprint
Thermal resistance, junction - ambient for SMD version	$R_{thJA}$	-	35	45	°C/W	Device on 40mm*40mm*1.5mm epoxy PCB FR4 with 6cm <sup>2</sup> (one layer, 70µm thickness) copper area for drain connection and cooling. PCB is vertical without air stream cooling.
Soldering temperature, wave- & reflow soldering allowed	$T_{sold}$	-	-	260	°C	reflow MSL2a

### 3 Electrical characteristics

at  $T_j=25^\circ\text{C}$ , unless otherwise specified

**Table 4 Static characteristics**

Parameter	Symbol	Values			Unit	Note / Test Condition
		Min.	Typ.	Max.		
Drain-source breakdown voltage	$V_{(BR)DSS}$	600	-	-	V	$V_{GS}=0\text{V}$ , $I_D=1\text{mA}$
Gate threshold voltage	$V_{(GS)th}$	3	3.5	4	V	$V_{DS}=V_{GS}$ , $I_D=0.8\text{mA}$
Zero gate voltage drain current	$I_{DSS}$	-	-	1	$\mu\text{A}$	$V_{DS}=600\text{V}$ , $V_{GS}=0\text{V}$ , $T_j=25^\circ\text{C}$ $V_{DS}=600\text{V}$ , $V_{GS}=0\text{V}$ , $T_j=150^\circ\text{C}$
Gate-source leakage current	$I_{GSS}$	-	-	100	nA	$V_{GS}=20\text{V}$ , $V_{DS}=0\text{V}$
Drain-source on-state resistance	$R_{DS(on)}$	-	0.053 0.123	0.065 -	$\Omega$	$V_{GS}=10\text{V}$ , $I_D=15.9\text{A}$ , $T_j=25^\circ\text{C}$ $V_{GS}=10\text{V}$ , $I_D=15.9\text{A}$ , $T_j=150^\circ\text{C}$
Gate resistance	$R_G$	-	2.8	-	$\Omega$	$f=1\text{MHz}$ , open drain

**Table 5 Dynamic characteristics**

Parameter	Symbol	Values			Unit	Note / Test Condition
		Min.	Typ.	Max.		
Input capacitance	$C_{iss}$	-	2895	-	pF	$V_{GS}=0\text{V}$ , $V_{DS}=400\text{V}$ , $f=250\text{kHz}$
Output capacitance	$C_{oss}$	-	48	-	pF	$V_{GS}=0\text{V}$ , $V_{DS}=400\text{V}$ , $f=250\text{kHz}$
Effective output capacitance, energy related <sup>1)</sup>	$C_{o(er)}$	-	89	-	pF	$V_{GS}=0\text{V}$ , $V_{DS}=0\dots400\text{V}$
Effective output capacitance, time related <sup>2)</sup>	$C_{o(tr)}$	-	924	-	pF	$I_D=\text{constant}$ , $V_{GS}=0\text{V}$ , $V_{DS}=0\dots400\text{V}$
Turn-on delay time	$t_{d(on)}$	-	16	-	ns	$V_{DD}=400\text{V}$ , $V_{GS}=13\text{V}$ , $I_D=15.9\text{A}$ , $R_G=3.3\Omega$ ; see table 9
Rise time	$t_r$	-	7	-	ns	$V_{DD}=400\text{V}$ , $V_{GS}=13\text{V}$ , $I_D=15.9\text{A}$ , $R_G=3.3\Omega$ ; see table 9
Turn-off delay time	$t_{d(off)}$	-	73	-	ns	$V_{DD}=400\text{V}$ , $V_{GS}=13\text{V}$ , $I_D=15.9\text{A}$ , $R_G=3.3\Omega$ ; see table 9
Fall time	$t_f$	-	4	-	ns	$V_{DD}=400\text{V}$ , $V_{GS}=13\text{V}$ , $I_D=15.9\text{A}$ , $R_G=3.3\Omega$ ; see table 9

**Table 6 Gate charge characteristics**

Parameter	Symbol	Values			Unit	Note / Test Condition
		Min.	Typ.	Max.		
Gate to source charge	$Q_{GS}$	-	15	-	nC	$V_{DD}=400\text{V}$ , $I_D=15.9\text{A}$ , $V_{GS}=0$ to $10\text{V}$
Gate to drain charge	$Q_{GD}$	-	20	-	nC	$V_{DD}=400\text{V}$ , $I_D=15.9\text{A}$ , $V_{GS}=0$ to $10\text{V}$
Gate charge total	$Q_g$	-	67	-	nC	$V_{DD}=400\text{V}$ , $I_D=15.9\text{A}$ , $V_{GS}=0$ to $10\text{V}$
Gate plateau voltage	$V_{plateau}$	-	5.2	-	V	$V_{DD}=400\text{V}$ , $I_D=15.9\text{A}$ , $V_{GS}=0$ to $10\text{V}$

<sup>1)</sup>  $C_{o(er)}$  is a fixed capacitance that gives the same stored energy as  $C_{oss}$  while  $V_{DS}$  is rising from 0 to 400V

<sup>2)</sup>  $C_{o(tr)}$  is a fixed capacitance that gives the same charging time as  $C_{oss}$  while  $V_{DS}$  is rising from 0 to 400V

**Table 7 Reverse diode characteristics**

Parameter	Symbol	Values			Unit	Note / Test Condition
		Min.	Typ.	Max.		
Diode forward voltage	$V_{SD}$	-	0.9	-	V	$V_{GS}=0V, I_F=15.9A, T_j=25^\circ C$
Reverse recovery time	$t_{rr}$	-	254	-	ns	$V_R=400V, I_F=6A, di_F/dt=100A/\mu s$ ; see table 8
Reverse recovery charge	$Q_{rr}$	-	2.9	-	$\mu C$	$V_R=400V, I_F=6A, di_F/dt=100A/\mu s$ ; see table 8
Peak reverse recovery current	$I_{rrm}$	-	23.1	-	A	$V_R=400V, I_F=6A, di_F/dt=100A/\mu s$ ; see table 8

### 4 Electrical characteristics diagrams

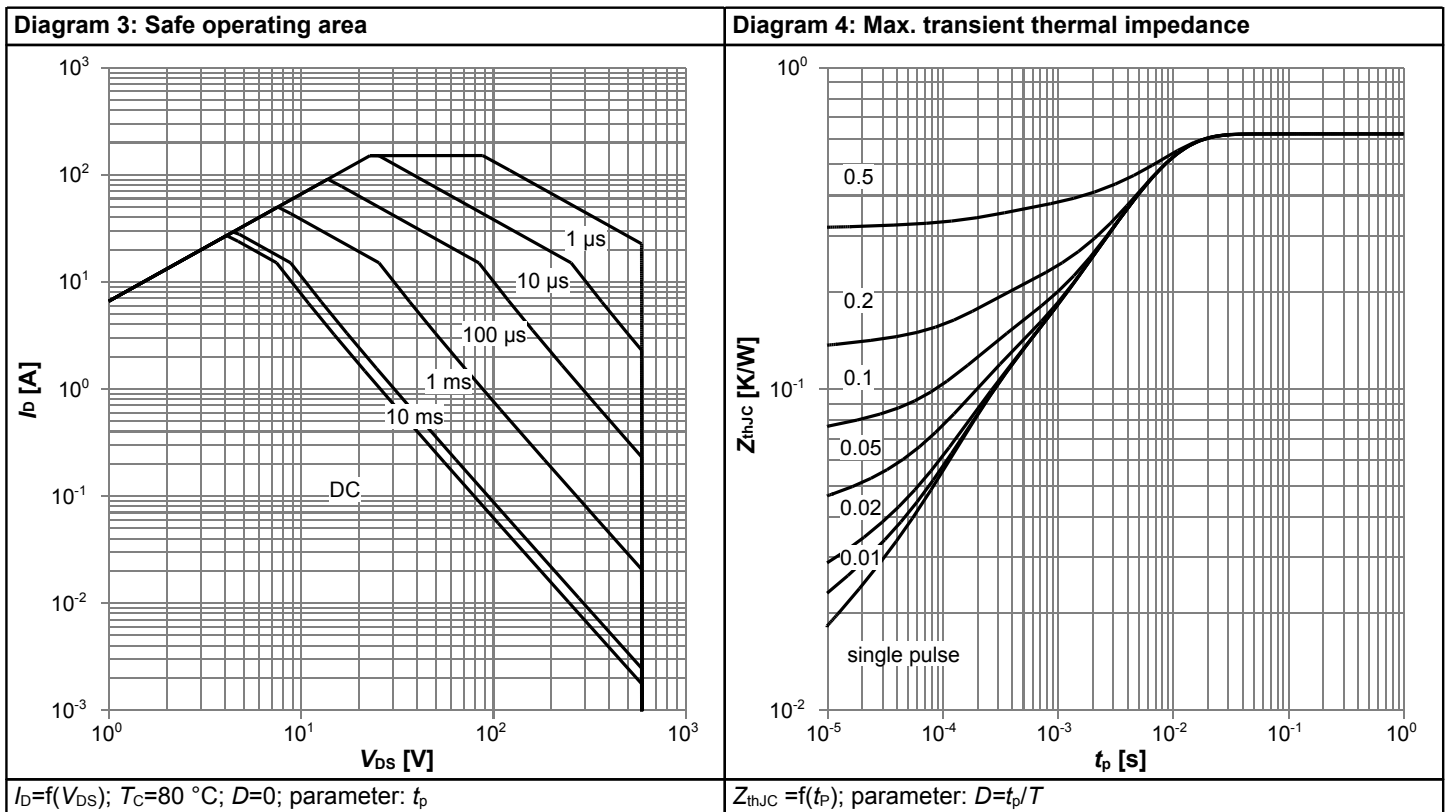
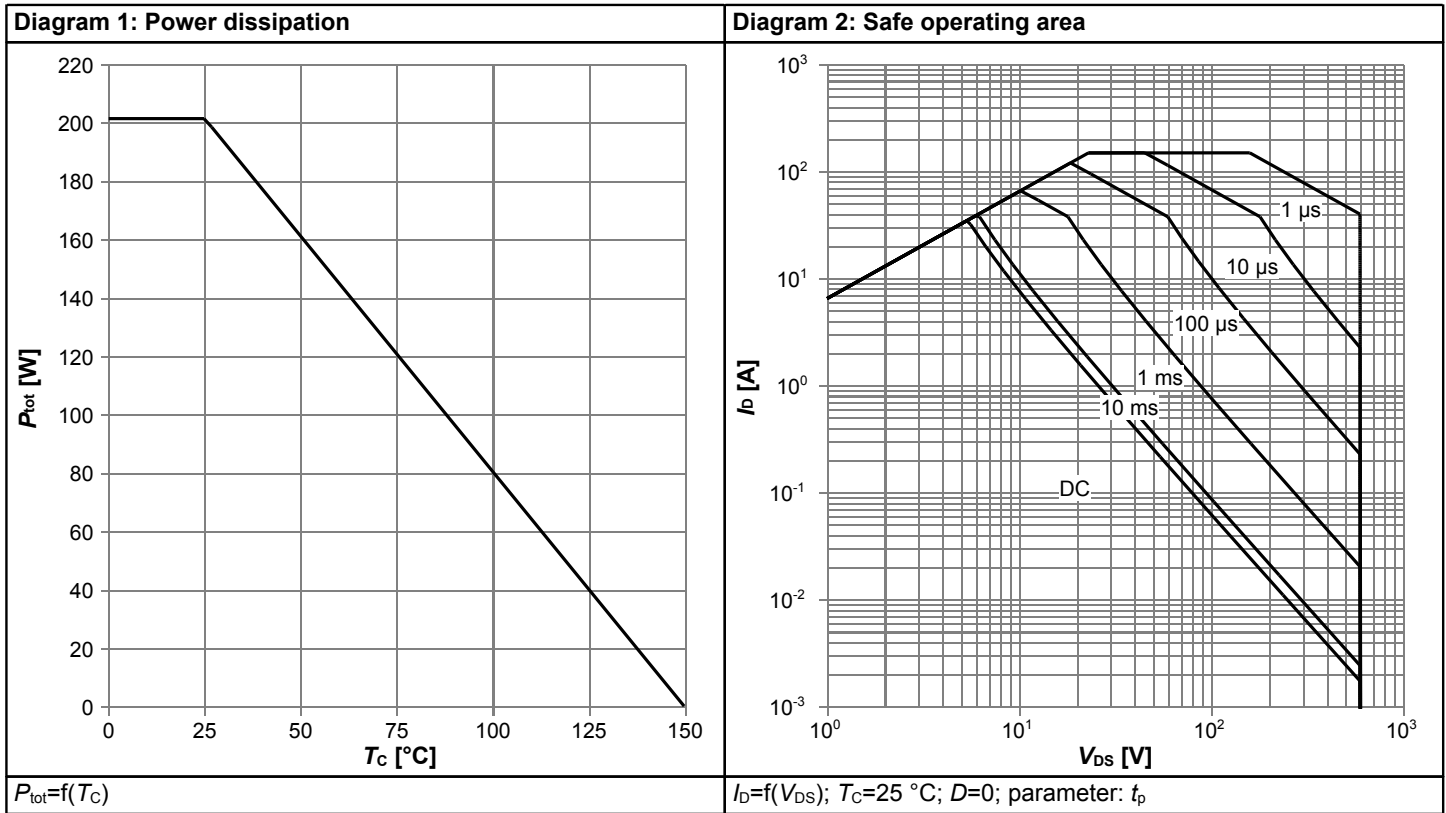
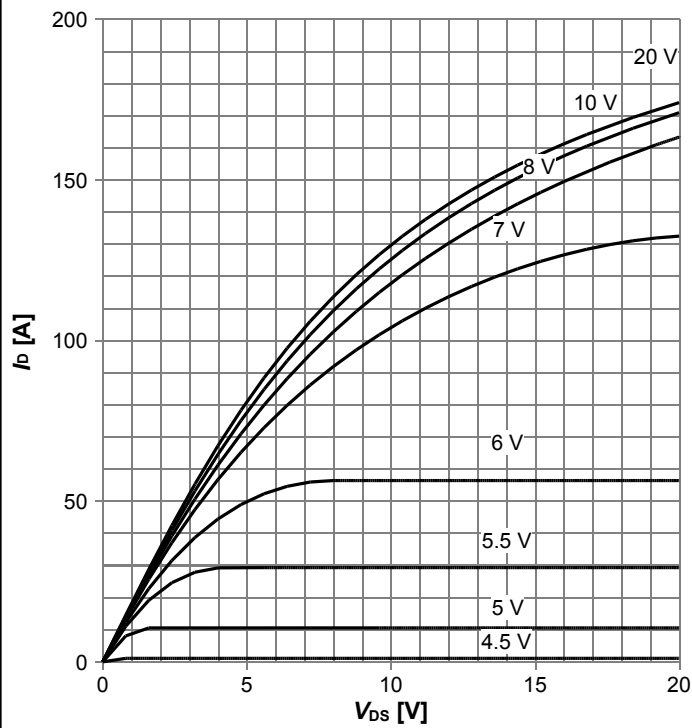
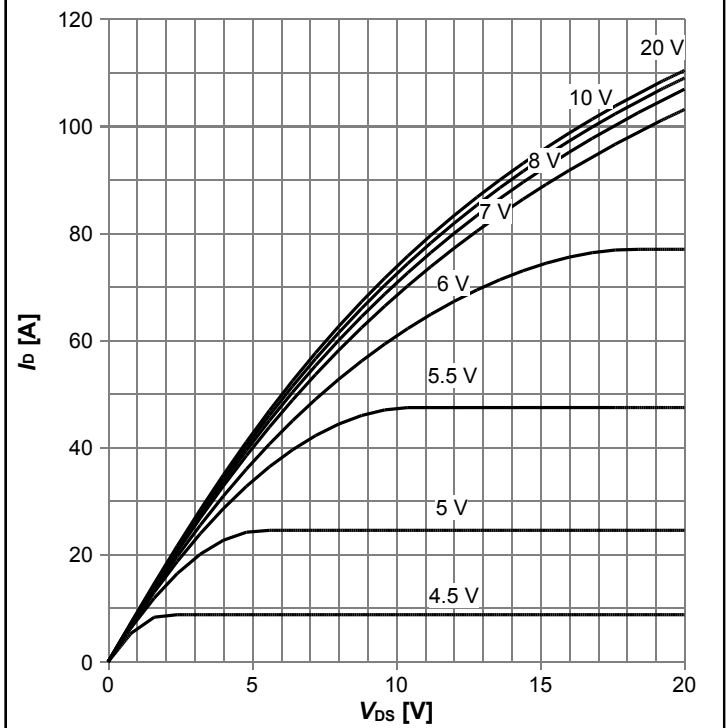

Diagram 5: Typ. output characteristics



$I_D=f(V_{DS})$ ;  $T_j=25\text{ °C}$ ; parameter:  $V_{GS}$

Diagram 6: Typ. output characteristics



$I_D=f(V_{DS})$ ;  $T_j=125\text{ °C}$ ; parameter:  $V_{GS}$

Diagram 7: Typ. drain-source on-state resistance

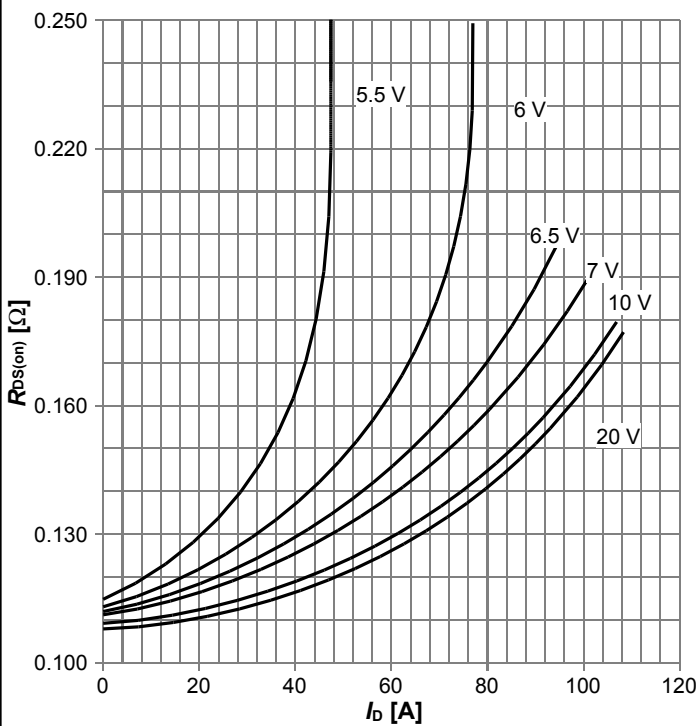

$R_{DS(on)}=f(I_D)$ ;  $T_j=125\text{ °C}$ ; parameter:  $V_{GS}$

Diagram 8: Drain-source on-state resistance

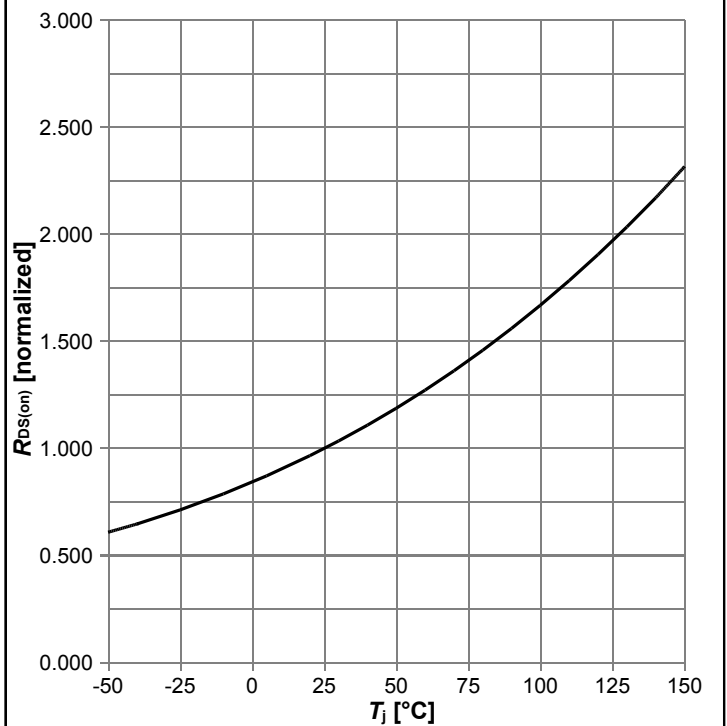

$R_{DS(on)}=f(T_j)$ ;  $I_D=15.9\text{ A}$ ;  $V_{GS}=10\text{ V}$

Diagram 9: Typ. transfer characteristics

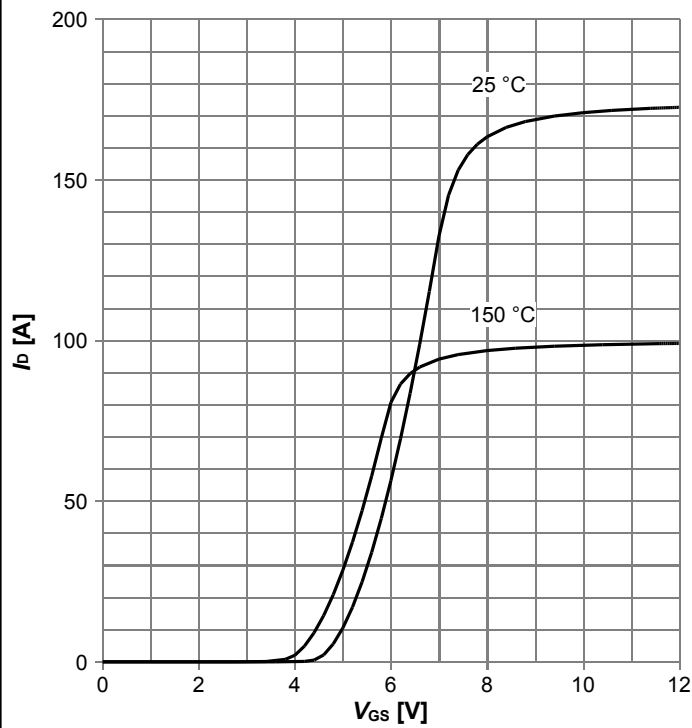

$I_D=f(V_{GS}); V_{DS}=20V; \text{parameter: } T_j$

Diagram 10: Typ. gate charge

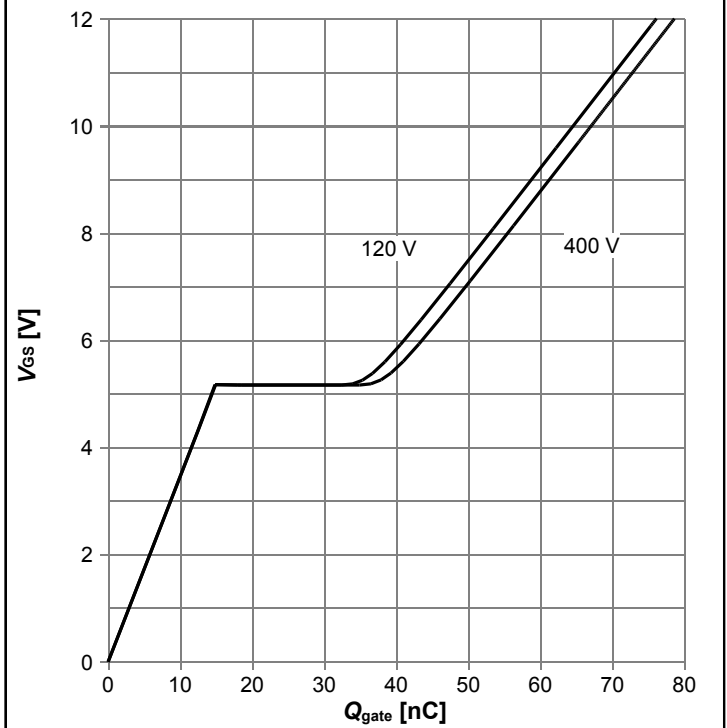

$V_{GS}=f(Q_{gate}); I_D=15.9 \text{ A pulsed}; \text{parameter: } V_{DD}$

Diagram 11: Forward characteristics of reverse diode

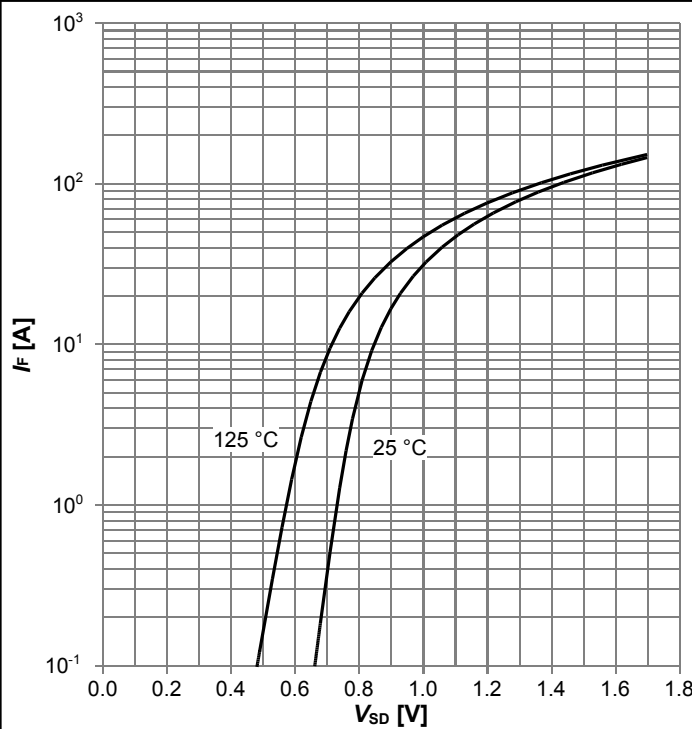

$I_F=f(V_{SD}); \text{parameter: } T_j$

Diagram 12: Avalanche energy

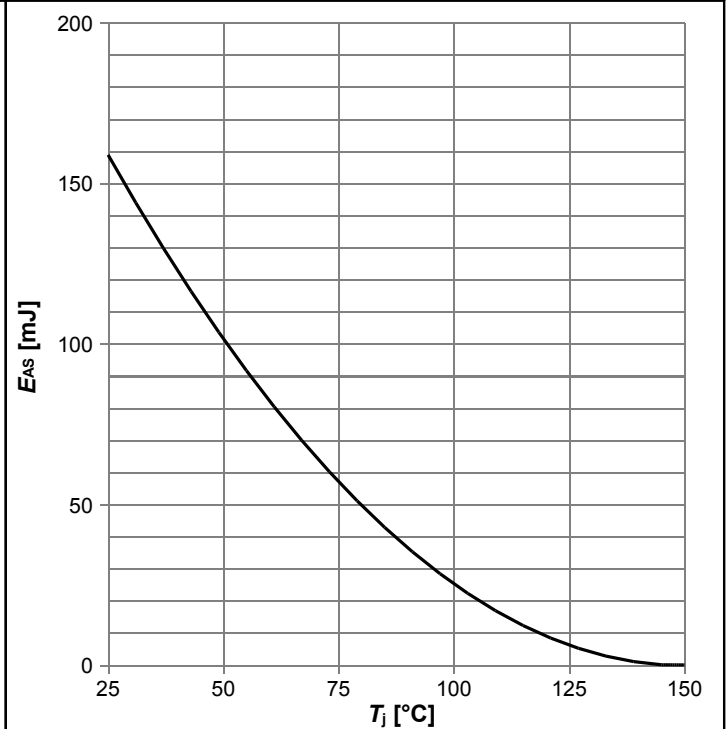

$E_{AS}=f(T_j); I_D=6.4 \text{ A}; V_{DD}=50 \text{ V}$

Diagram 13: Drain-source breakdown voltage



$V_{BR(DSS)}=f(T_j); I_D=1 \text{ mA}$

Diagram 14: Typ. capacitances

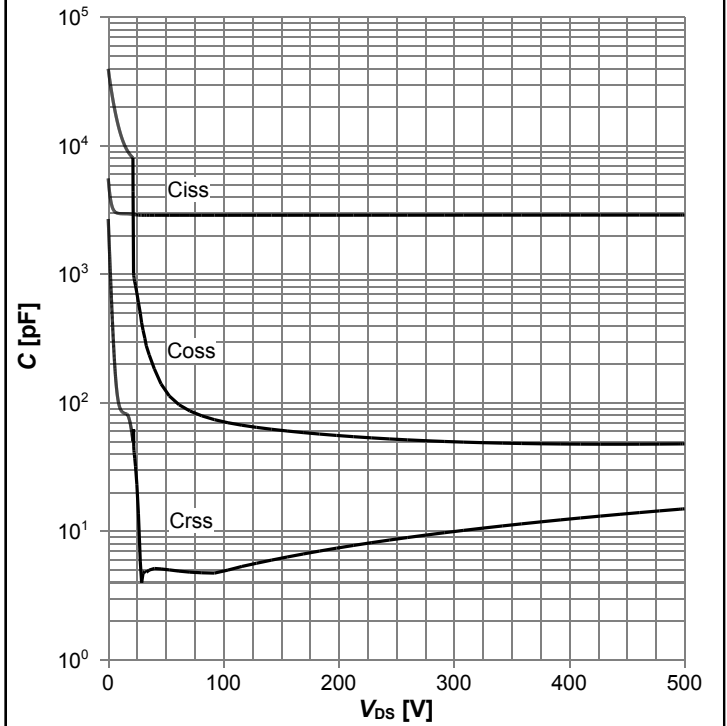

$C=f(V_{DS}); V_{GS}=0 \text{ V}; f=250 \text{ kHz}$

Diagram 15: Typ. Coss stored energy

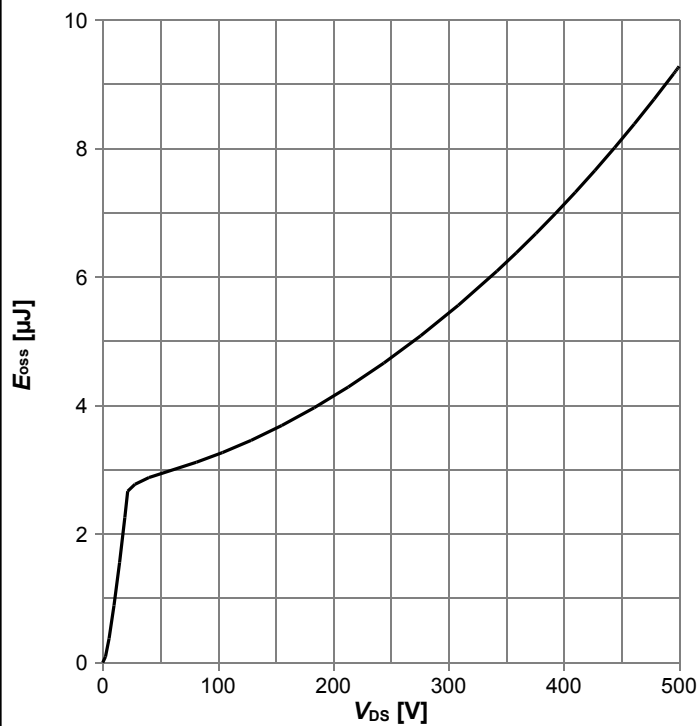

$E_{oss}=f(V_{DS})$

## 5 Test Circuits

**Table 8 Diode characteristics**



**Table 9 Switching times (ss)**

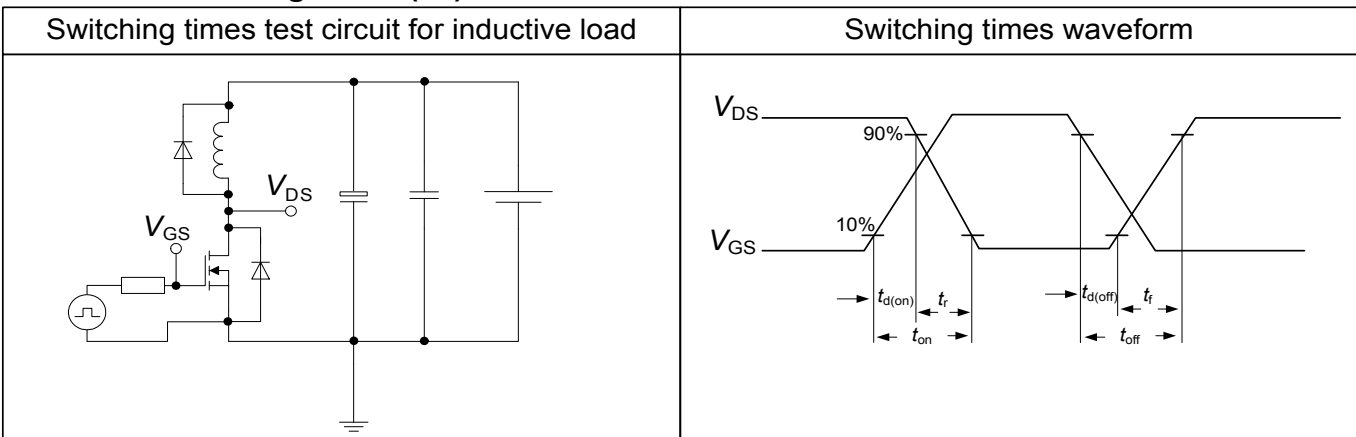

**Table 10 Unclamped inductive load (ss)**

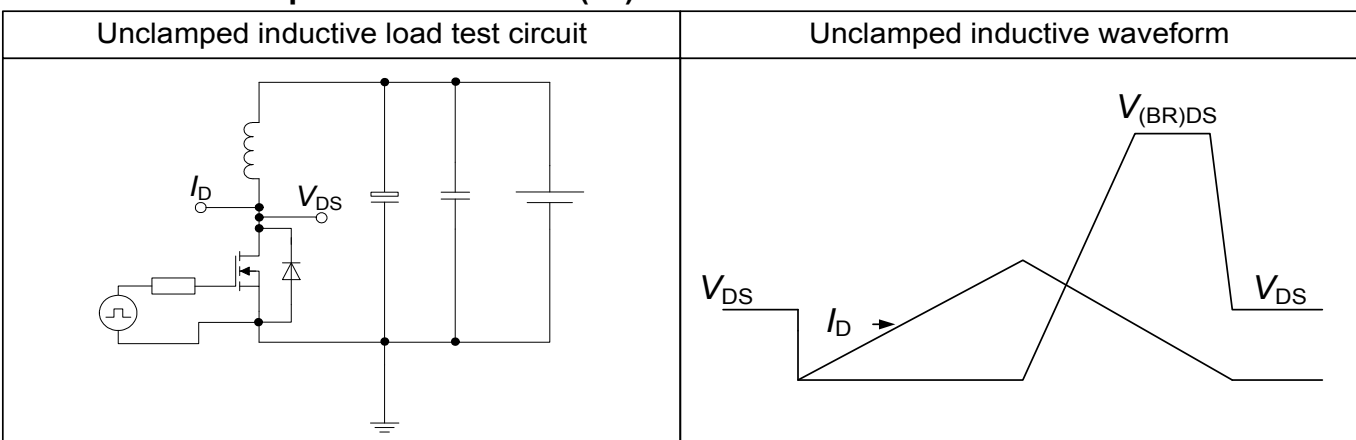

## 6 Package Outlines

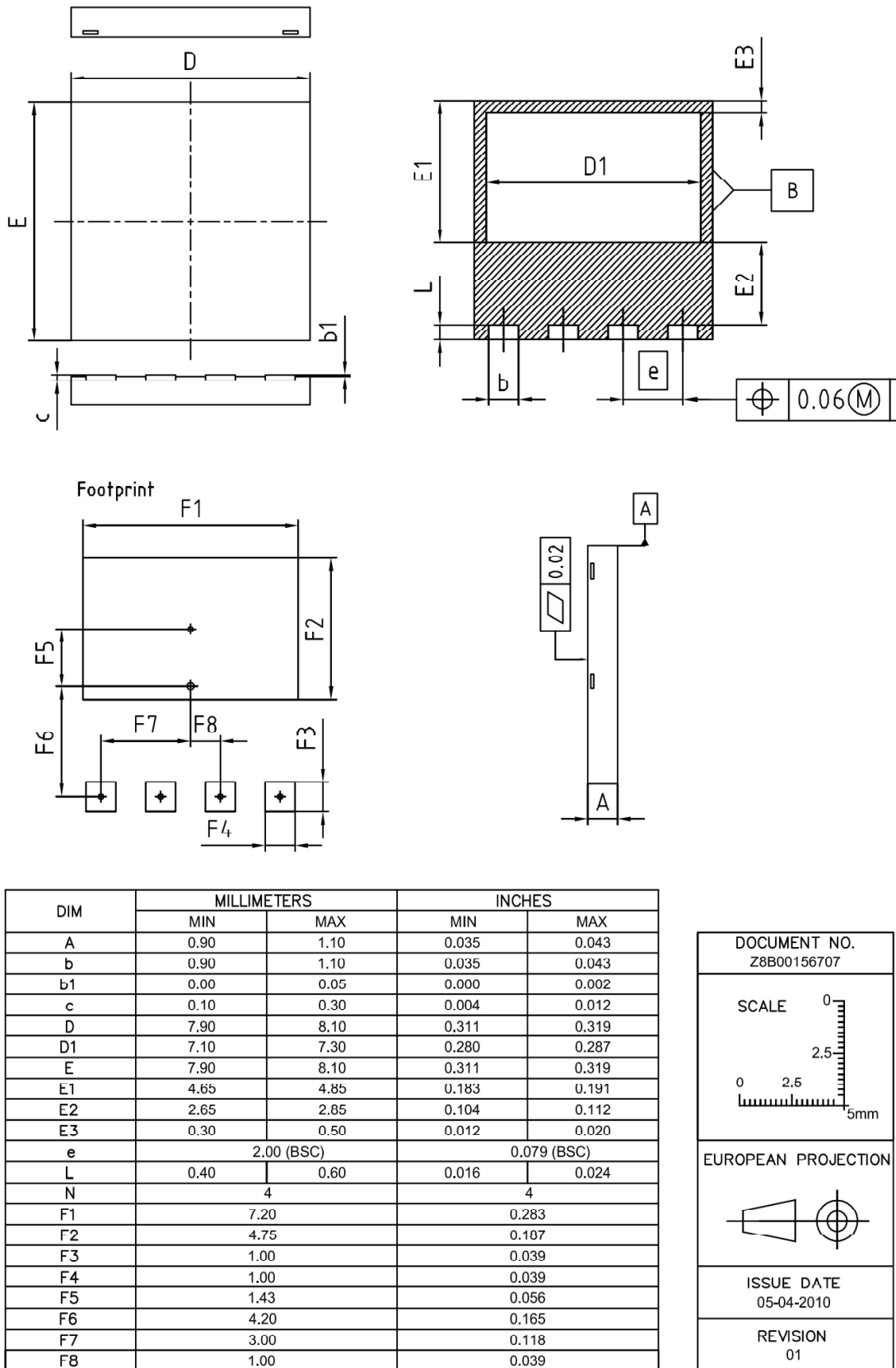

Figure 1 Outline PG-VSON-4, dimensions in mm/inches

## 7 Appendix A

### Table 11 Related Links

- IFX CoolMOS P7 Webpage: [www.infineon.com](http://www.infineon.com)
- IFX CoolMOS P7 application note: [www.infineon.com](http://www.infineon.com)
- IFX CoolMOS P7 simulation model: [www.infineon.com](http://www.infineon.com)
- IFX Design tools: [www.infineon.com](http://www.infineon.com)

## Revision History

IPL60R065P7

**Revision: 2018-05-15, Rev. 2.1**

Previous Revision

Revision	Date	Subjects (major changes since last revision)
2.0	2017-09-19	Release of final version
2.1	2018-05-15	Nomenclature of product qualification grade was changed

### Trademarks

All referenced product or service names and trademarks are the property of their respective owners.

### We Listen to Your Comments

Any information within this document that you feel is wrong, unclear or missing at all? Your feedback will help us to continuously improve the quality of this document. Please send your proposal (including a reference to this document) to:

**erratum@infineon.com**

### Published by

**Infineon Technologies AG**

**81726 München, Germany**

**© 2018 Infineon Technologies AG**

**All Rights Reserved.**

### Legal Disclaimer

The information given in this document shall in no event be regarded as a guarantee of conditions or characteristics ("Beschaffenheitsgarantie").

With respect to any examples, hints or any typical values stated herein and/or any information regarding the application of the product, Infineon Technologies hereby disclaims any and all warranties and liabilities of any kind, including without limitation warranties of non-infringement of intellectual property rights of any third party.

In addition, any information given in this document is subject to customer's compliance with its obligations stated in this document and any applicable legal requirements, norms and standards concerning customer's products and any use of the product of Infineon Technologies in customer's applications.

The data contained in this document is exclusively intended for technically trained staff. It is the responsibility of customer's technical departments to evaluate the suitability of the product for the intended application and the completeness of the product information given in this document with respect to such application.

### Information

For further information on technology, delivery terms and conditions and prices please contact your nearest Infineon Technologies Office ([www.infineon.com](http://www.infineon.com)).



### Warnings

Due to technical requirements, components may contain dangerous substances. For information on the types in question, please contact the nearest Infineon Technologies Office.

The Infineon Technologies component described in this Data Sheet may be used in life-support devices or systems and/or automotive, aviation and aerospace applications or systems only with the express written approval of Infineon Technologies, if a failure of such components can reasonably be expected to cause the failure of that life-support, automotive, aviation and aerospace device or system or to affect the safety or effectiveness of that device or system. Life support devices or systems are intended to be implanted in the human body or to support and/or maintain and sustain and/or protect human life. If they fail, it is reasonable to assume that the health of the user or other persons may be endangered.

## Looking for pricing, stock, or lifecycle information?

Click below to explore more details on WIN SOURCE:

-  [View IPL60R065P7AUMA1 on WIN SOURCE](#)
-  [Infineon Technologies Information](#)

## Optimize Your Supply Chain with WIN SOURCE Solutions

-  Global Sourcing Solution
-  Obsolete Management
-  Cost Control Management
-  Shortage Management
-  Alternative Solution
-  Excess Inventory Management