



**THE DATASHEET OF
IQS211A-00000000-TSR**





IQS211A Datasheet

Single Channel Capacitive Proximity/Touch Controller with movement detection

The IQS211A ProSense® IC is a self-capacitance controller designed for applications where an awake/activate on proximity/touch function is required. The IQS211A is an ultra-low power solution that uses movement detection for applications that require long term detection. The IQS211A operates standalone or I²C and can be configured via OTP (One Time Programmable) bits.

Features

- Pin compatible with IQS127D/ 128/ 227AS/ 228AS/ 231A
- **Automatic Tuning Implementation (ATI)**
- On-chip movement detection algorithm
- Forced activation when movement detected
- Minimal external components
- Down to 10aF capacitance resolution
- Up to 60pF sensor load (with effective movement detection)
- Up to 200pF sensor load for touch application
- Multiple **One-Time-Programmable (OTP)** options
- **Standalone** direct outputs:
 - Primary output (configurable)
Default: **ACTIVATION**
 - Secondary output (configurable)
Default: **MOVEMENT**
- **1-Wire streaming** interface:
 - 1-Wire & event CLK signal
 - Valuable for debugging
- **Various I²C configurations:**
 - Normal polling
 - Polling with RDY interrupt on SCL

RoHS2
Compliant

6 pin TSOT23-6
Representations only,
not actual markings

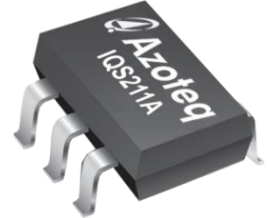

- Runtime switch to standalone mode
- **Separate MOVEMENT output selection:** Pulse Frequency Modulation (PFM, default), Pulse Width Modulation (PWM), Latched, or PWM only active in activation
- **Low power consumption:**
 - 80uA (50 Hz response),
 - 20uA (20 Hz response)
 - sub-2uA (LP mode, optional zoom to scanning mode with wake-up)
- **Low power options:**
 - Low power without activation
 - Low power within activation
 - Low power standby modes with proximity wake-up / reset wake-up
- **Internal Capacitor Implementation (ICI)**
- Supply voltage: 1.8V to 3.3V
- Low profile TSOT23-6 package

Applications

- Wearable devices
- Movement detection devices (fitness, anti-theft)
- White goods and appliances
- Human Interface Devices
- Proximity activated backlighting
- Applications with long-term activation

Available Packages

T _A	TSOT23-6
-20°C to 85°C	IQS211A

1 Functional block diagram

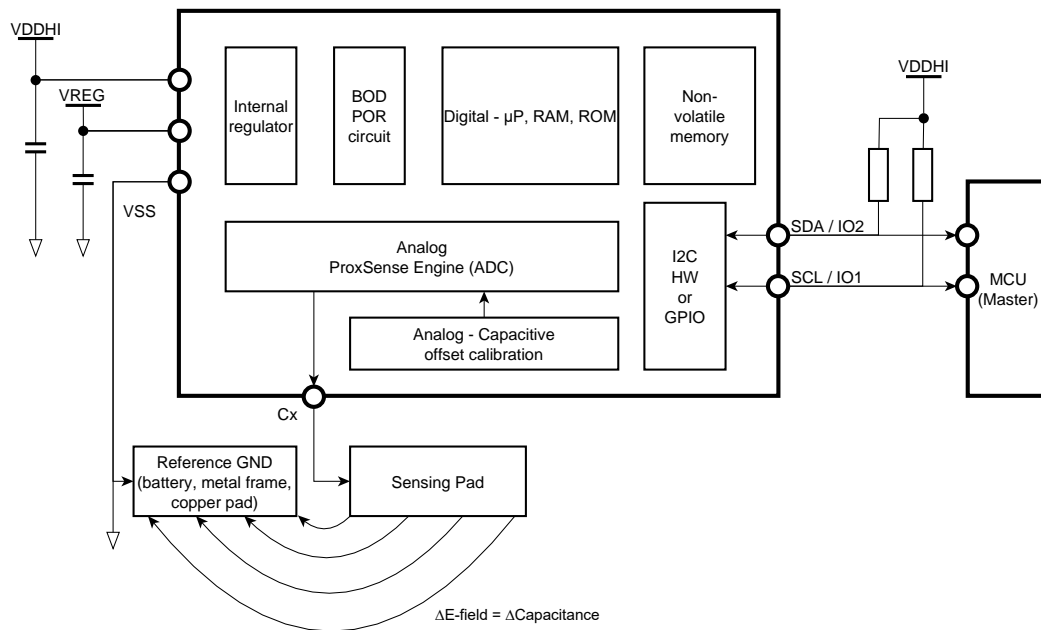

Figure 1-1 IQS211A functional block diagram

The IQS211A supports relative capacitance measurements for detecting capacitance changes.

Basic features of the IQS211A include:

- Charge-transfer capacitance measurement technology (Analog ProxSense® Engine)
- Finite state machine to automate detection and environmental compensation without MCU interaction (integrated microprocessor)
- Self-capacitance measurements
- Signal conditioning to provide signal gain (Analog – Capacitive offset calibration)
- Signal conditioning to provide offset compensation for parasitic capacitance (Analog – Capacitive offset calibration)
- Integrated calibration capacitors (Analog – Capacitive offset calibration)
- Integrated timer for timer triggered conversions
- Integrated LDO regulator for increased immunity to power supply noise
- Integrated oscillator
- Processing logic to perform measurement filtering, environmental compensation, threshold detection and movement detection

2 Packaging and Pin-Out

The IQS211A is available in a TSOT23-6 package.

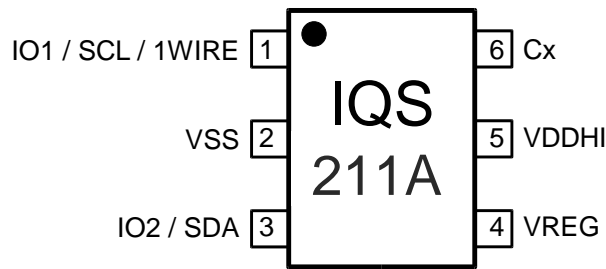

Figure 2-1 IQS211A pin-out (TSOT23-6 package)

Table 2.1 Pin-out description

IQS211A in TSOT23-6			
Pin	Name	Type	Function
1	PRIMARY I/O	Digital Input/Output	Multifunction IO1 / SCL (I ² C Clock signal) / 1WIRE (data streaming)
2	VSS	Signal GND	
3	SECONDARY I/O	Digital Input/Output	Multifunction IO2 / SDA (I ² C Data output)
4	VREG	Regulator output	Requires external capacitor
5	VDDHI	Supply Input	Supply: 1.8V – 3.6V
6	Cx	Sense electrode	Connect to conductive area intended for sensor

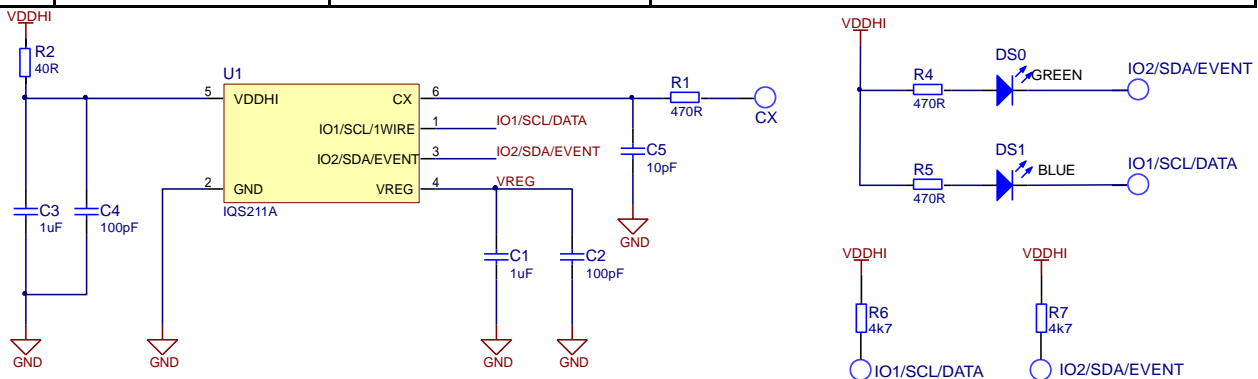

Figure 2-2 IQS211A reference schematic

Figure 2-2 shows the following:

- Schematic for default power mode, see guide for capacitor selection in low power modes below:

Low power scan time	8ms (default) - 32ms	64ms	128ms	256ms
Capacitor recommendation	C1 = 1µF C3 = 1µF	C1 = 1µF C3 = 2.2µF	C1 = 2.2µF C3 = 4.7µF	C1 = 4.7µF C3 = 10µF

- C5 = 10pF load. This can be changed for slight variations in sensitivity. The recommended value is 1pF to 60pF, depending on the capacitance of the rest of the layout.
- R1 = 470Ω 0603 for added ESD protection



- * R2: Place a 40Ω resistor in the VDDHI supply line to prevent a potential ESD induced latch-up. Maximum supply current should be limited to 80mA on the IQS211A VDDHI pin to prevent latch-up.

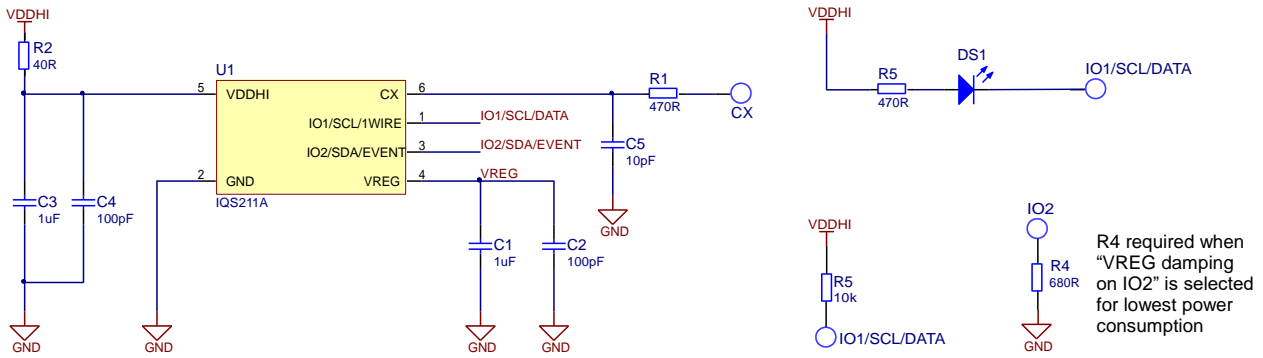

Figure 2-3 IQS211A reference schematic for ultra-low power (ULP) modes with VREG damping through IO2 selected (OTP bank3:bit3)



3 Configuration Options

The IQS211A offers various user selectable options. These options may be selected via I²C setup or one-time programmable (OTP) configuration. OTP settings may be ordered pre-programmed for bulk orders. I²C setup allows access to all device settings while entering direct output mode as soon as selected by the MCU.

Azoteq offers a Configuration Tool (CT210 or later) and associated software that can be used to program the OTP user options for prototyping purposes. For further information regarding this subject, please contact your local distributor or submit enquiries to Azoteq at: info@azoteq.com



3.1 User Selectable OTP options

OTP bank 0								IQS211A 000000xx TSR (ordering code)							
Bit7		6		5		4		3		2		1		Bit 0	
Base Value / Coarse multiplier				Scan times				Prox wake-up				Low-power scan time			
00 – 150 counts / 0 01 – 75 / 1 10 – 100 / 2 11 – 200 / 3 See Proxsense® sensitivity				Idle / Active 00 - 9/9ms 01 - 9/64 10 - 32/32 11 - 32/64 See Figure 4-11				0 – Active direction 1 – Both directions				000 - 9ms 001 - 32ms 010 - 64ms 011 - 96ms 100 - 128ms 101 - 160ms 110 - 192ms 111 - 256ms } sub-2µA			
OTP Bank 1								IQS211A 0000xx00 TSR							
Bit7		6		5		4		3		2		1		Bit 0	
Touch late release (50%)				Filter halt / Wake-up threshold				Touch threshold				Movement threshold			
0 – Disabled 1 – Enabled				00 – 4 counts (+2 LP) 01 – 2 (+2 LP) 10 – 8 (+2 LP) 11 – 16 (+2 LP)				000 – 6/256 of LTA 001 – 2/256 010 – 16/256 011 – 32/256 100 – 48/256 101 – 64/256 110 – 80/256 111 – 96/256				00 – 3 counts 01 – 6 10 – 15 11 – 2			
OTP Bank 2								IQS211A 00xx0000 TSR							
Bit7		6		5		4		3		2		1		Bit 0	
Reseed after no movement time				Movement output type				Output / User interface selection							
000 - 2s 001 - 5s 010 - 20s 011 - 1min 100 - 2min 101 - 10min 110 - 60min 111 - always halt				00 - Normal (PFM) 01 - PWM 10 - Constant Movement , clears upon no movement timeout 11 - PFM combined with activation output				000 - Activation(IO1) & Movement(IO2) 001 - Movement Latch(IO1) and Movement (IO2) 010 - Movement(IO1) & Input(IO2) 011 - Touch (IO1), Prox (IO2) 100 - 1Wire (IO1) & Clk (IO2) (only on events) 101 - I2C (polling*) no wakeup 110 - I2C with reset indication+RDY toggle on SCL 111 - I2C (polling*) +Wakeup +RDY toggle on SCL I2C address fixed on 0x47 Runtime change from I2C to standalone is possible							
OTP Bank 3								IQS211A 0x000000 TSR							
Bit7		6		5		4		3		2		1		Bit 0	
Reserved				VREG damping through IO2				AC Filter				Halt charge / Reseed on IO1			
				0 – Disabled 1 – Enabled (sub-2µA)				0 – Normal 1 – Increased				0 – Disabled 1 – Enabled			
												0 – Normal / Halt charge 1 – PWM / Reduce sensitivity			
OTP Bank 4								IQS211A x0000000 TSR							
Bit7		6		5		4		3		2		1		Bit 0	
Reserved				ATI partial				Auto activation (when compensation multiplier > 7)				ATI target			
				0 – Disabled 1 – Enabled				0 – Disabled 1 – Enabled				00 – 768 counts 01 – 1200 10 – 384 11 – 192 } sub-2µA			

* For sub-2µA power consumption see: "Low-power scan time", "VREG damping" and "ATI target" settings ([example configuration](#))



3.2 I²C registers

Table 1.1 I²C communications layout

I2C Communications Layout											
Address/Command/Byte	Register name/s	R/W	Default Value	Bit 7	Bit 6	Bit 5	Bit 4	Bit 3	Bit 2	Bit 1	Bit 0
00H	PRODUCT_NUM	R	0x3D								
01H	VERSION_NUM	R	0x01								
10H	SYSFLAGS0	R/W		Movement	Movement Constant	PROX	TOUCH	Show Reset	ATI Busy	Filter Halt	LP Active
41H	Movement Value	R									
42H	CS_H	R									
43H	CS_L	R									
83H	LTA_H	R									
84H	LTA_L	R									
90H	Touch Threshold_H										
91H	Touch Threshold_L										
C4H	MULTIPLIERS	R/W		n/a	n/a	Coarse multiplier		Fine multiplier			
C5H	COMPENSATION	R/W						0-255			
C6H	PROX_SETTINGS0	R/W		Base Value/ Coarse multiplier for Partial ATI: 00 – 150/0 01 – 75/1 10 – 100/2 11 – 200/3		Do reseed	Redo ATI	0 – Active direction 1 – Both directions		000 - 9ms 001 - 32ms 010 - 64ms 011 - 96ms 100 - 128ms 101 - 160ms 110 - 192ms 111 - 256ms	
C7H	PROX_SETTINGS1	R/W		0 – Auto reseed is in seconds 1 – Auto reseed is in minutes	If UI type 011: 0- Halt charge/Reseed 1- Reduce sensitivity If UI type 000: 0- Normal 1- PWM touch out	Halt Charge/Reseed on IO1, with IO1 set as output	00 –Normal (PFM) 01 – PWM 10 – Constant Movement , clears upon no movement timeout 11 – PFM combined with activation output	000 –Activation(IO1) & Movement(IO2) 001 –Movement Latch(IO1) and Movement (IO2) 010 – Movement(IO1) & Input(IO2) 011 – Touch (IO1), Prox (IO2) 100 – 1Wire (IO1) & Clk (IO2) (only on events) 101 – I2C (polling) no wakeup 110 - I2C with reset indication +RDY toggle on SCL 111 – I2C (polling) + Wakeup + RDY toggle on SCL	It is possible to change to non-I2C modes when in I2C mode. I2C functionality will only return after a power cycle		
C8H	PROX_SETTINGS2	R/W		0 – Prox Timeout of 2s 1 – Prox timeout of 20s	n/a	AUTO Activation on start up	n/a	Touch Late Release (50%)	Partial ATI enabled	Auto ATI off	Increase AC filters, increase touch threshold with 10counts, halt with 4
C9H	ATI_TARGET	R/W									x * 8 = ATI target
CAH	LP_PERIOD	R/W									x * 16ms = sleep time
CBH	PROX_THRESHOLD	R/W									
CCH	TOUCH_THRESHOLD	R/W									
CDH	MOVEMENT_THRESHOLD	R/W									
CEH	AUTO_RESEED_LIMIT	R/W									in Seconds or Minutes, based on PROX_SETTINGS1 bit 7.

4 Overview

4.1 Device characteristics

The IQS211A is a device tailored for long term proximity or touch activations. It mainly offers two digital output pins, one with an activation threshold for large capacitive shifts and the other with a

mode also has access to all these settings.

The movement output may be chosen to have a specific characteristic. This may be PFM (movement intensity via pulse count per time window), PWM, latched output or PWM combined with the normal threshold activation.

4.1.1 Normal threshold operation

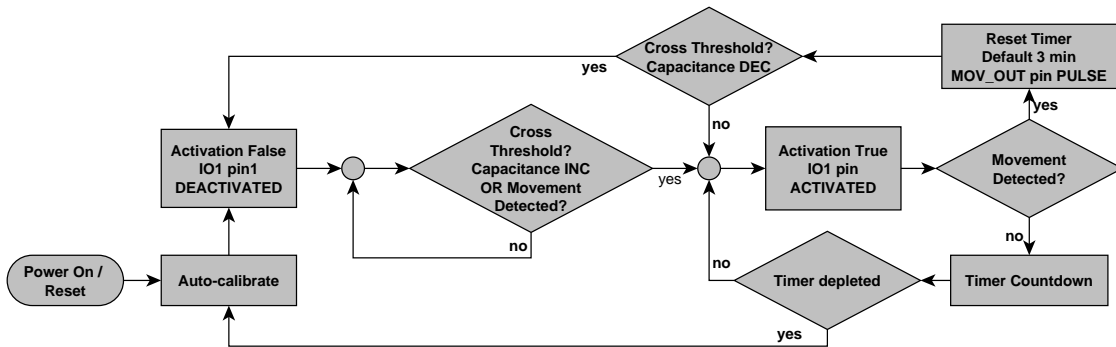

Figure 4-1 Flow diagram of the typical IQS211A movement based user interface

threshold for small movements even during a normal activation. There are also a few options to combine these two digital outputs where the application only allows for 1 output pin. These two outputs may be read via the IC pins in standalone mode or used for communications via I²C or 1-Wire streaming mode.

With a normal activation (hand brought close) the output will become active. The output will de-activate as soon as the action is reversed (hand taken away). In addition a separate movement output will become active when movement is detected according to a movement threshold. Movement may be detected before the

Various configurations are available via [one-time programmable \(OTP\) options](#). I²C

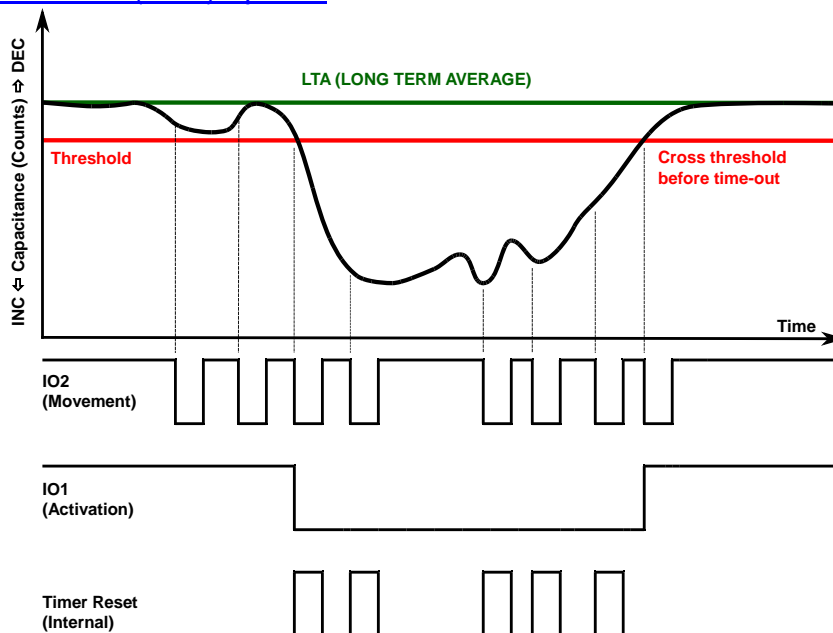

Figure 4-2 Plot of IQS211A streaming data along with the digital

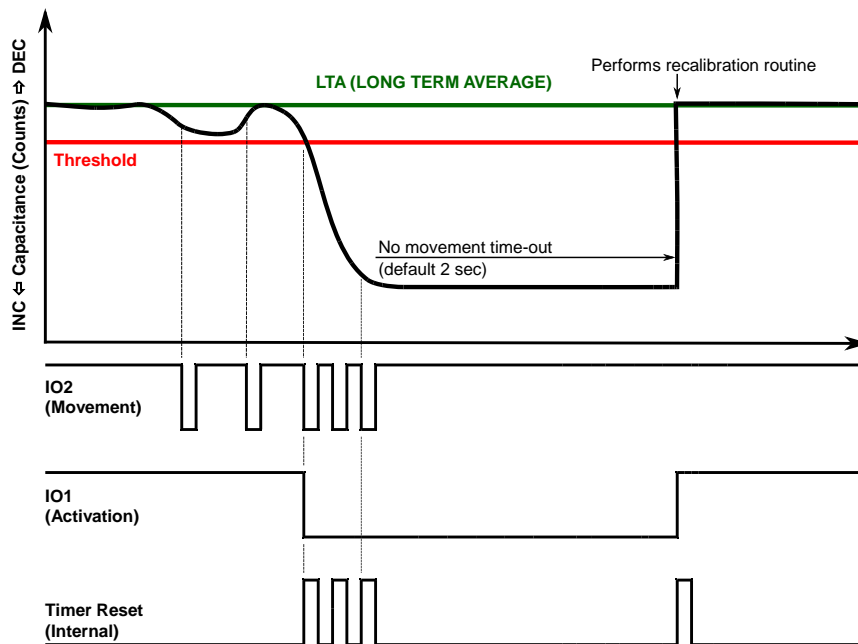

Figure 4-3 Example of a time-out event with re-calibration

normal threshold is crossed. Movement detection is done via a completely separate digital filter while improving the efficiency of the sensor output (timer reset on movement).

In a normal activation the output will stay active for as long as movements are detected. A time-out timer (configurable time) will be reset with each movement.

4.1.2 Output forced by movement

There is the option to force the output active for each movement detected. The output will be cleared as soon as there is no movement for the selected timer period.

4.1.3 Long term recovery

When changing the sensor capacitive environment, the sensor will adapt to the new environment. If the new environment decreases capacitance (wooden table to air), the sensor will rapidly adapt in order to accept new human activations. If the new environment increases capacitance (like air to steel table), the sensor will remain in activation until a time-out occurs (as seen in Figure 4-3) or until the device is returned to its previous environment.

When the timer runs out, the output will be de-activated. Re-calibration is possible after de-activation because the timer will only time-out with no movement around the sensor.

4.1.4 Choosing a user interface

The user interface can be defined via [OTP options](#) or via an [I²C register](#)

ACTIVATION & MOVEMENT UI

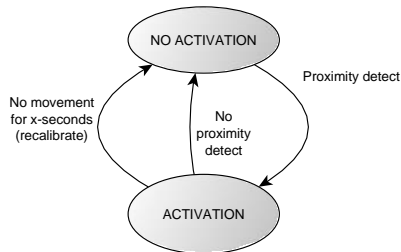

Figure 4-4 ACTIVATION & MOVEMENT UI state diagram

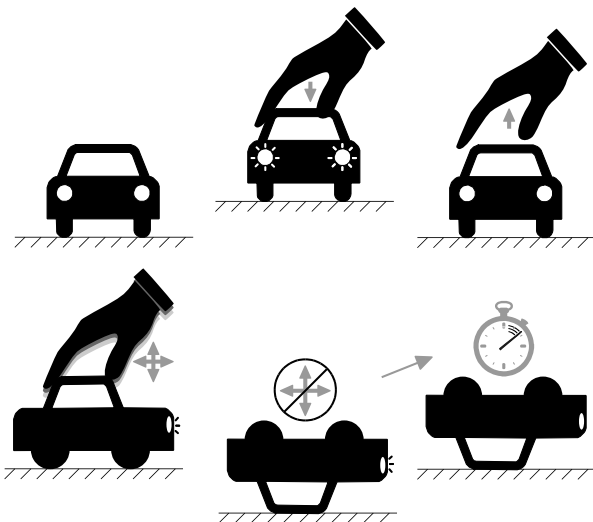

Figure 4-5 Toy car example of default UI

1. Lights off
2. Touch roof, lights on
3. No touch on roof, lights off
4. While in use (movement), lights on
5. Roof on ground = touch
6. No movement causes time-out, lights off

MOVEMENT LATCH & MOVEMENT UI

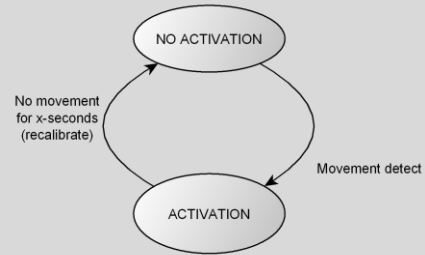

Figure 4-6 MOVEMENT LATCH UI state diagram

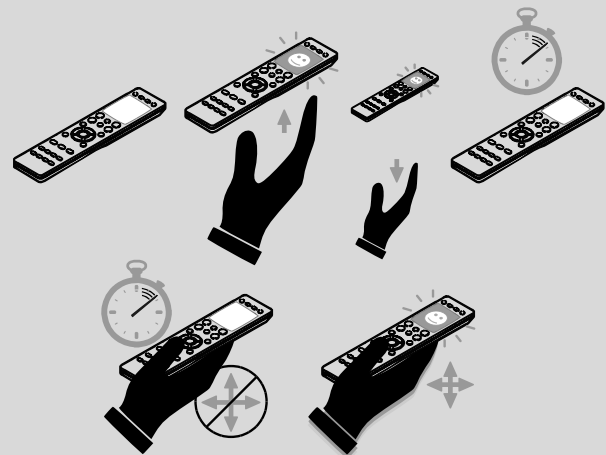

Figure 4-7 Remote control example of movement latch UI application

1. Remote backlight/LCD off
2. Hand close to remote = LCD on
3. Hand away, then LCD remains on
4. LCD off after no movement time-out
5. If remote in hand, but LCD off, then any small movement turns on LCD.
6. While in hand and movement, LCD remains on.

MOVEMENT & INPUT UI

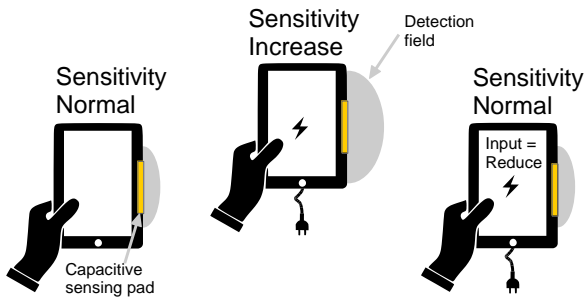

Figure 4-8 Device charging example of input UI

Device is operating on battery with designed sensitivity

Device is plugged-in for charging

Device ground reference changes and sensitivity increases

Input is given to reduce sensitivity

4.1.5 Integrated features

The device includes an internal voltage regulator and reference capacitor (C_s).

Various advanced signal processing techniques are combined for creating a robust solution.

These techniques include:

- Movement detection filter (to release an activation in the case of inactivity)
- Advanced noise filtering on incoming sample stream
- Superior methods of parasitic capacitance compensation while preserving sensitivity
- Unique option for capacitive load dependant activation on power-on

PROX & TOUCH UI

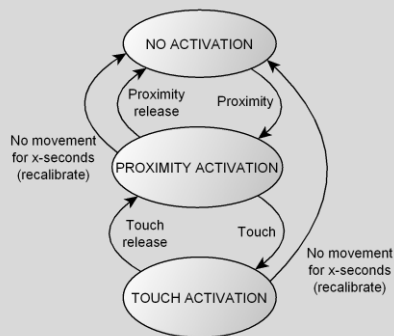

Figure 4-9 Proximity and touch state diagram



Figure 4-10 Proximity and touch UI example

Proximity to the device activates proximity output

Touching the device activates the touch output (proximity remains triggered)

Movement features are integrated and function the same as in the default “ACTIVATION & MOVEMENT” user interface

4.1.6 Communications protocols

The IQS211A offers a wide range of data streaming modes each with a specific purpose.

Standard 2-wire I²C polling is offered to access the [entire range of settings and data](#) offered by the IQS211A.

Another I²C option allows the device to be configured via I²C then jump to any of the other modes when the communication window is closed. This option is offered to give full control over selecting settings while simplifying the main-loop code by only responding to direct digital outputs. The digital output pair will contain signature pulses to indicate power-on reset or an unexpected reset occurrence. I²C configuration should be re-initiated in the event of an IQS211A reset.

A 1-wire data streaming interface is offered for access to a variety of data over a single line. The 1-wire implementation may be enhanced (by using the IO2 pin) by only reading data when the IO2 clock pin toggles. The clock pin will only toggle when an event is active and produce a clock signal during this active period.

1-wire data streaming is a special use case for debugging with optical isolation and



Azoteq PC software. For other requirements, please contact Azoteq at info@azoteq.com

4.1.7 Automatic Calibration

Proven Automatic Tuning Implementation (ATI) algorithms are used to calibrate the device to the sense electrode. This algorithm is optimised for applications where a fixed detection distance is required.

4.1.8 Capacitive sensing method

The *charge transfer* method of capacitive sensing is employed on the IQS211A. Charge is continuously transferred from the Cx capacitor into a charge collection capacitor (internal) until this capacitor reaches a trip voltage. A “transfer cycle” refers to the charging of Cx and transferring the charge to the collection capacitor. The “charge cycle” refers to process of charging the collection capacitor to a trip voltage using charge transfers. A charge cycle is used to take a measurement of the capacitance of a sense “pad” or “electrode” relative to signal earth at a specific time.

4.2 Operation

4.2.1 Device Setup

The device may be purchased pre-configured (large orders or popular configurations), programmed in-circuit during production or simply setup via I²C.

4.2.2 Movement filter response

The movement filter runs continually and the dedicated digital output will activate in PFM (pulse frequency modulation), PWM or latched mode.

4.2.3 External control

With certain user interfaces, the “multifunction IO2” (optional line to connect to master device) can be used to signal:

- a “halt (sleep mode) and reseed” or “reduce sensitivity” in MOV&INPUT mode.

- a “halt (sleep mode) and reseed” in ACT&MOV mode. When enabled, the ACT output reads the input periodically.

RESEED

A short pulse ($t > 15\text{ms}$, $t < 25\text{ms}$) will force the reference counts (long-term average) to match the actual counts (capacitance of sensor). The short pulse for a reseed operation also applies to the user configurable input option: “Reduce sensitivity”.

HALT CHARGE (& RESET)

By writing the pin low for a longer time ($t > 50\text{ms}$), will force the IC into “halt charge” for low current consumption. It is important to consider current through the pull-up resistor when in sleep mode.

The IC will perform a soft reset as soon as the pin is released after 50ms or more. With a soft reset the IC will remember the activation state when going into the “halt charge” mode. The state will be recalled at the reset operation and cleared along with the calibration.

In order to achieve a “halt charge” state with minimal power consumption it is recommended to configure the MCU output as push-pull for the input pin and perform the “halt charge”. With the “movement latch” function defined, do the operation twice to clear a possible activation at the time of calling a “halt charge”.

REDUCE SENSITIVITY

With a configurable bit the system sensitivity may be changed. The input may be used to reduce sensitivity in the following way:

- AC filter doubles in strength
- Proximity threshold (filter halt) is increased by 4 counts
- Activation threshold is increased by 10 counts
- Movement sensitivity threshold is not changed

4.2.4 Low power options

Various low-power configurations are offered in order to achieve the required current consumption during activated and non-activated conditions.

These low power configurations make the power consumption and product response highly configurable during various events.

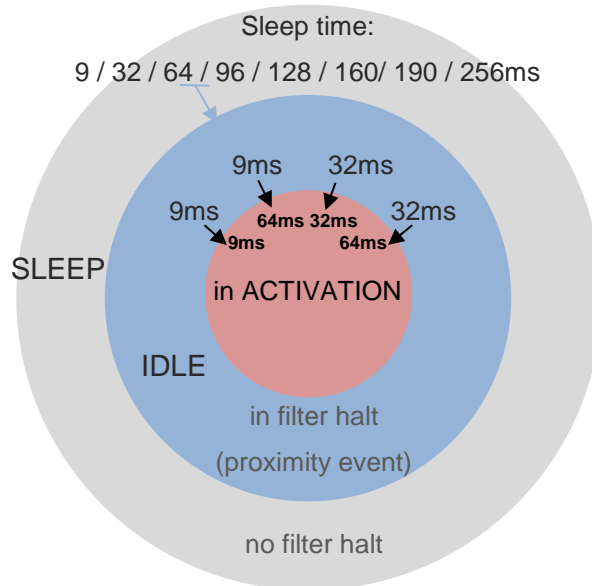

Figure 4-11 Low power mode description from outside (no interaction), to inside (full interaction)

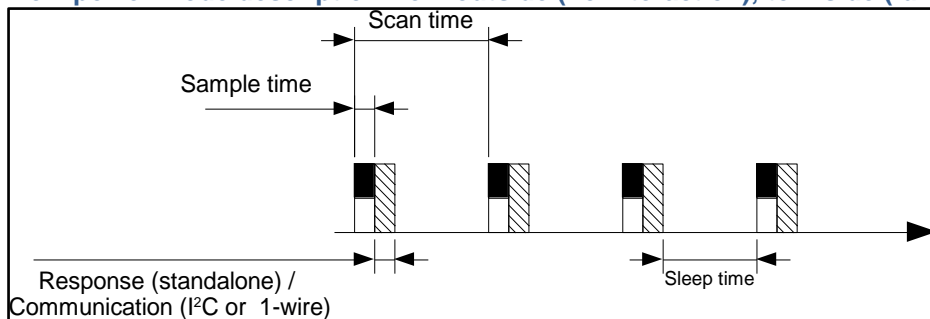

Figure 4-12 Sample-, scan-, sleep- and communication time diagram

4.3 ProxSense® sensitivity

The measurement circuitry uses a temperature stable internal sample capacitor (C_S) and internal regulated voltage (V_{REG}). Internal regulation provides for more accurate measurements over temperature variation.

The Automatic Tuning Implementation (ATI) is a sophisticated technology implemented on the ProxSense® series devices. It allows for optimal performance of the devices for a wide range of sense electrode capacitances, without modification or addition of external components. The ATI functionality ensures that sensor sensitivity is not affected by external influences such as temperate, parasitic capacitance and ground reference changes.

The ATI process adjusts three values (Coarse multiplier, Fine multiplier, Compensation) using two parameters (ATI base and ATI target) as inputs. An 8-bit compensation value ensures that an accurate target is reached. The base value influences the overall sensitivity of the channel and establishes a base count from where the ATI algorithm starts executing. A rough estimation of sensitivity can be calculated as:



$$Sensitivity \propto \frac{Target}{Base}$$

As seen from this equation, the sensitivity can be increased by either increasing the Target value or decreasing the Base value. A lower base value will typically result in lower multipliers and more compensation would be required. It should, however, be noted that a higher sensitivity will yield a higher noise susceptibility.

4.4 Applicability

All specifications, except where specifically mentioned otherwise, provided by this datasheet are applicable to the following ranges:

Temperature: -20C to +85C

Supply voltage (V_{DDHI}): 1.8V to 3.6V



5 Details on user configurable options

5.1.1 Bank 0: Sensitivity and scan time adjustments

Bank0: bit 7:6	Base Value (Sensitivity Multiplier in Partial ATI mode)
-----------------------	--

See [Proxsense® sensitivity](#).

Changing the base value enables the designer to adjust sensitivity. Lower base values will increase sensitivity and are recommended for systems with a high SNR ratio. Higher base values will prevent noise from being amplified, but will result in less sensitivity.

With **Bank4: bit 2** set (partial ATI), the area of operation may be fixed to a certain extent. This is ideal for stationary applications where a specific type of trigger is expected.

With **Bank4: bit 0** set (auto-activation $P > 7$), partial ATI must be enabled to ensure the desired results. With the “Sensitivity Multiplier” fixed, the P value will indicate whether a certain threshold has been crossed at power-up.

Bank0: bit 5:4	IDLE (proximity) / ACTIVE (touch) scan time
-----------------------	--

Select an IDLE / ACTIVE combination scan time to achieve the desired response with target power consumption in mind.

Bank0: bit 3	Prox wake-up direction
---------------------	-------------------------------

Active direction – only go to IDLE (proximity) scan time when an actual proximity event occurs.

Both directions – go to IDLE (proximity) scan time when a proximity event occurs or when a significant environment change occurs. This mode will enable quick touch response in a dynamic environment (for example devices used on the human wrist)

Bank0: bit 2:0	SLEEP (no proximity) low power scan time
-----------------------	---

Select a SLEEP scan time to determine the most significant power consumption figure of the device.

5.1.2 Bank 1: Threshold adjustments

Bank1: bit 7	Touch late release (50% of touch threshold)
---------------------	--

This option will enable a user interface where activation would occur as usual, but the deactivation will occur at a relaxed threshold. It will therefore counter unwanted false releases. This option is ideal for handheld devices that will active with a typical “grab” action, but will not release when the grip on the device is relaxed.

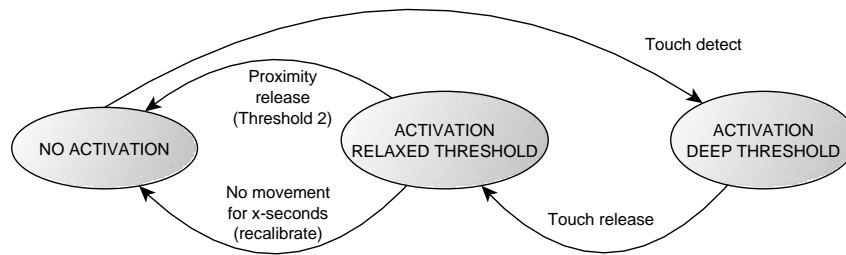

Figure 5-1 State diagram of touch late release interface

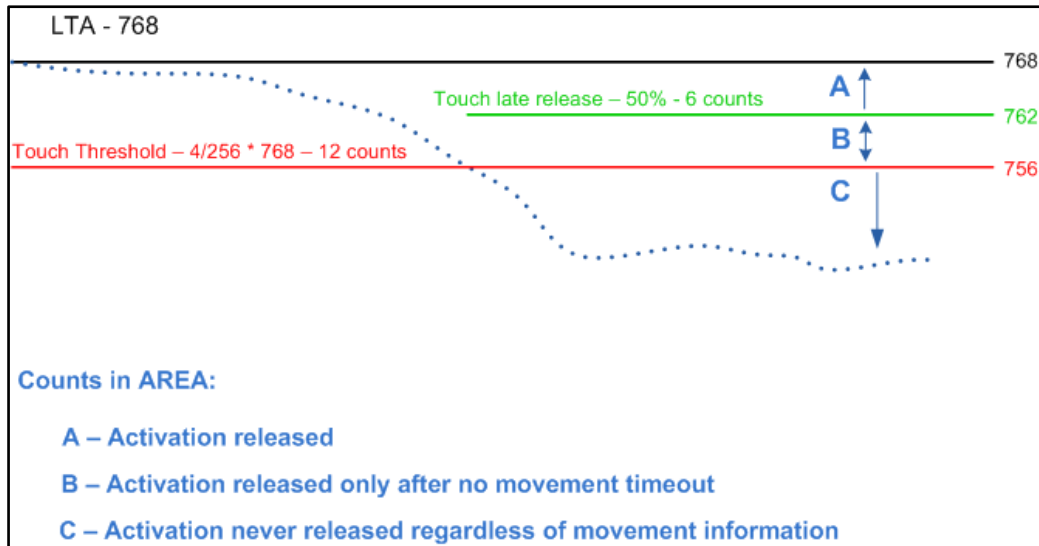

Figure 5-2 Touch late release example

Bank1: bit 6:5	Proximity threshold (delta counts from LTA)
<p>The proximity threshold may be chosen to halt the filters that allow for temperature drift and other environmental effects. Choose a low value in order to increase the trigger distance for slow proximity activations. Choose a high value if the device and/or sensing electrode overlay is in a highly variable temperature environment. A high value is also recommended for touch button implementations with the IQS211A. This threshold will not trigger any of the output signals in most of the user interface options. The result of this threshold becomes an output in the “Proximity and touch” user interface option, where movement is only operating in the background.</p>	
Bank1: bit 4:2	Touch threshold (delta percentage from LTA)
<p>The touch threshold is the highly variable threshold that will determine the triggering of the activation output. This threshold may be chosen for various proximity trigger distances (low values 1 to 15) including a few settings that allow for the implementation of a touch button (high values 15 to 90)</p>	
Bank1: bit 1:0	Movement threshold (delta counts from movement average)

The movement threshold is chosen according to the dynamic response longed for, but also according to the signal-to-noise ratio of the system. Battery powered applications generally deliver much higher SNR values, allowing for lower movement thresholds.

5.1.3 Bank 2: Timer, output type and user interface adjustment

Bank2: bit 7:5	Reseed after no movement timer
-----------------------	---------------------------------------

Depending on the user interface chosen, the activation output will clear when no movement is detected for the period selected here. This feature enables long-term detection in interactive applications while eliminating the risk of a device becoming stuck when placed on an inanimate object.

Bank2: bit 4:3	Movement output type
-----------------------	-----------------------------

The movement output is a secondary output (normally IO2 pin) that may be used as the main output or supporting output. This output may be altered to suit the requirements of various applications. When user interface of “**IO1: Movement; IO2: Input**” is selected this output will be at the IO1 pin.

'00' – The default pulse frequency modulated (PFM) signal indicates intensity of movement by the density of pulses. This is a relatively slow output that may trigger occasional interrupts on the master side. See Figure 5-3. Most intense detectable movements are indicated by active low pulses with 10ms width (20ms period). Saturated movement intensity is indicated by a constant low.

'01' – The pulse width modulation (PWM) option is ideal for driving analogue loads. This signal runs at 1 kHz and the duty cycle is adapted according to the movement intensity.

'10' – The movement latched option triggers the output as soon as any movement is detected. The output only clears when no movement is sensed for the time defined in [Bank2: bit 7:5](#).

'11' – The same PFM-type output as in the '00' setting, but here the output will only become active once the activation threshold is reached.

'00' – PFM (pulse frequency modulation)

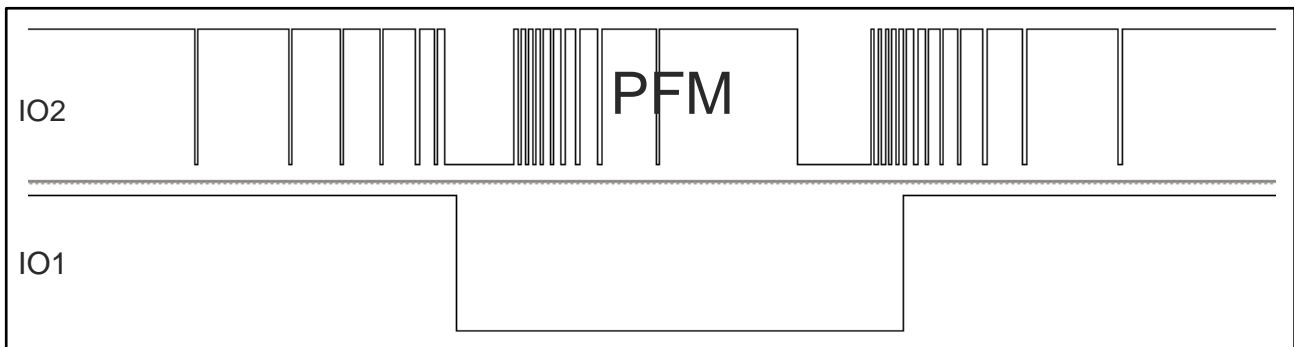

Figure 5-3 Movement (PFM) and activation output

'01' – PWM

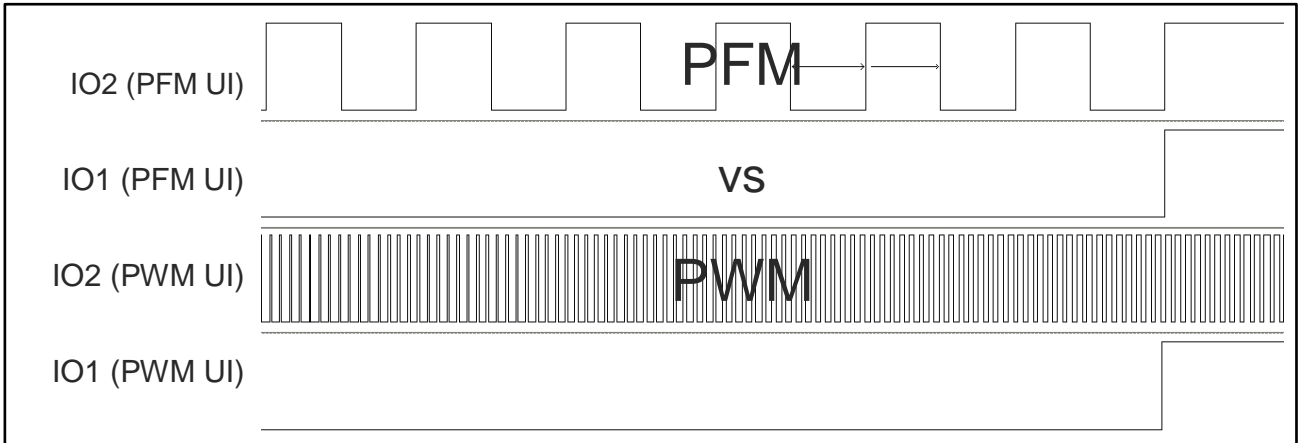

Figure 5-4 PFM movement output (TOP: 15ms period minimum) compared with PWM movement output (BOTTOM: 1ms period)

'10' – Latched (forces output for duration of timer)

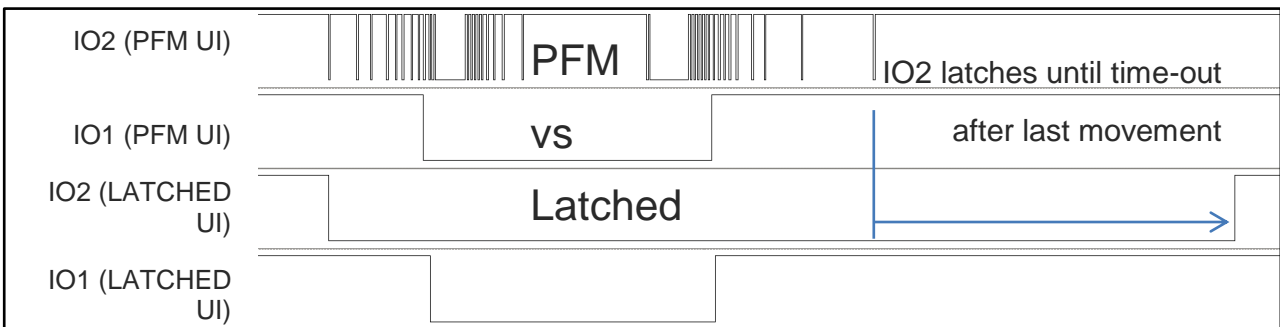

Figure 5-5 PFM movement output (TOP) compared with latched movement output (BOTTOM). Movement output is forced by first movement

'11' – PWM (only active during activation)

Bank2: bit 2:0	User interface selection
-----------------------	---------------------------------

Follow the links in the [OTP summary](#) for information on the various options.



5.1.4 Bank 3: VREG damping, sample filter, input control and output PWM

Bank3: bit 3	VREG damping on IO2
---------------------	----------------------------

With this option enabled, be sure to follow the schematic in Figure 2-3.

Current consumption is optimized through minimising processor awake time. With the damping option enabled, the VREG stabilisation time is significantly decreased, effectively optimizing processor wake time. In low μA power modes, this has a significant effect.

Bank3: bit 2	AC filter increase
---------------------	---------------------------

With the AC filter increase enabled, the reaction time slows with more rapid changes being filtered out. This option is ideal for a system connected to a power supply with increased noise

Bank3: bit 1	Activation output with input reseed & reset (halt charge) feature
---------------------	--

Extended IO1 definition: “000” Activation & Movement UI / “001” Movement latch output (forced) & Movement UI

With digital outputs enabled the IO1 pin has the option of being an input to “halt charge” / “reseed”. A short pulse ($t > 15\text{ms}$, $t < 25\text{ms}$) will initiate a reseed action ($\text{LTA} = \text{counts} - 8$) and a longer pulse ($t > 50\text{ms}$) will enable a lower power mode without sensing. The IQS211A will reset after the longer pulse is released (after a “halt charge” the IC will reset).

Bank3: bit 0	Multifunction Bit (applies only to certain UIs)
---------------------	--

Output definition: “000” Activation & Movement UI:

The IO1 pin normally only triggering with crossing of the threshold can be configured to output the depth of activation in PWM data. This is ideal for interpreting the specific activation level with a master, or for simply indicating the activation level on an analogue load.

Please note that when enabling this option, the PWM option on the IO2 pin will be disabled (**Bank2: bit 4:3** option ‘01’ will be the same as ‘00’)

Input definition: “010” Movement & Input UI:

By selecting the UI with the IO2 pin defined as an input, this configuration bit will enable the choice of input between the following

‘0’ – The halt charge & reseed option as defined above or

‘1’ – Reduce movement sensitivity for applications that may switch between battery usage and more noisy power supplies for charging and back-up power.



5.1.5 Bank 4: Partial ATI, ATI target and power-on detection

Bank4: bit 3	Partial ATI
---------------------	--------------------

Partial ATI may be selected to limit the automatic tuning range of the sensor. This may give more predictable results, especially when the sensor tends to calibrate close to the edges by automatically choosing a certain sensitivity multiplier value. Set this bit and select a specific sensitivity multiplier value in **Base Value (Sensitivity Multiplier in Partial ATI mode)**. A lower sensitivity multiplier value is recommended for light capacitive loads, while higher values for large capacitive loads.

Set this bit if the auto-activation at power-up bit is set (**Bank4: bit 0**). By setting this bit, the auto activation “threshold” is chosen by selecting a sensitivity multiplier value **Base Value (Sensitivity Multiplier in Partial ATI mode)**. A lower sensitivity multiplier value will result in a sensitive threshold, while higher values will give a less sensitive threshold.

Bank4: bit 2	Auto Activation at power-up when P>7 (absolute capacitance detection method, partial ATI must be enabled, select sensitivity with the “Sensitivity Multiplier”)
---------------------	---

With (**Bank4: bit 3**) set this option allows for absolute capacitance detection at power-up. Use this in devices that require a threshold decision at power-up without the calibration step. Select a “threshold” by adjusting the sensitivity multiplier value in **Base Value (Sensitivity Multiplier in Partial ATI mode)**. A lower sensitivity multiplier value will result in a sensitive “threshold”, while higher values will give a less sensitive “threshold”.

Bank4: bit 1:0	ATI target
-----------------------	-------------------

The default target of 768 ensures good performance in various environments. Set this bit when increased activation distance and movement sensitivity is required.

The target of 1200 is recommended for battery powered devices where high SNR ratios are expected.

Targets of 384 and 192 are for touch applications where power consumption and processor wake time are to be optimized.

Movement features are most pronounced and effective when using a high target.

6 I²C operation

The IQS211A may be configured as an I²C device through the user interface selection in Bank2: bits 2:0:

Bank2: bits 2:0	Description
101	Normal polling for use on I ² C bus
110	I ² C polling with signature pulses at power-up / reset. The clock also has a RDY pulse incorporated before each possible communications window.
111	The clock also has a RDY pulse incorporated before each possible communications window. The IC will wake-up on I ² C bus pin changes.

6.1 Normal I²C polling (101)

The IQS211A prioritizes doing capacitive conversions. With standard polling the IQS211A will do a conversion and thereafter open the window of maximum 20ms for I2C communications. If the microprocessor sends the correct address in this window, the IQS211A will respond with an ACK. When communications are successful, the window will close and conversions will continue.

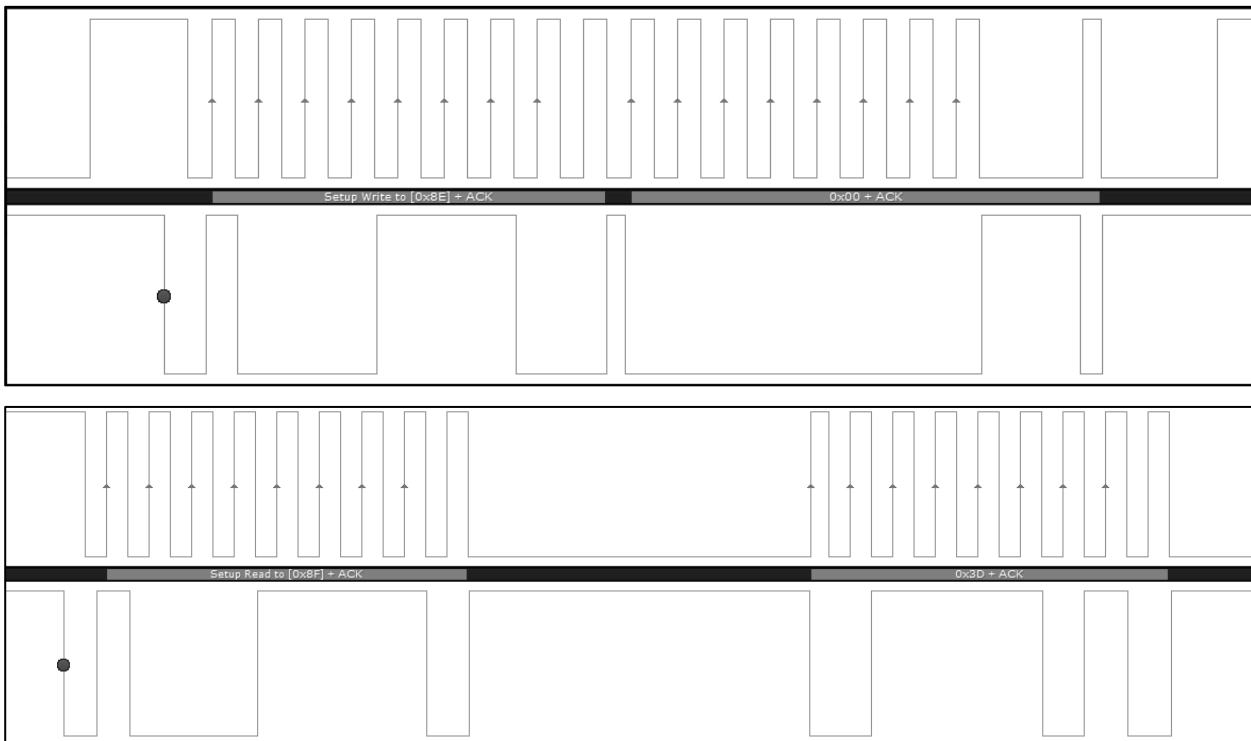

Figure 6-1 Typical polling example of IQS211A. The sequence addresses register 0x00 (top) and reads data (0x3D) from register 0x00 (bottom)

6.2 I²C polling with reset indication & RDY (110)

This mode is based on I²C, but not I²C compatible. This mode is aimed at solutions that need the flexibility of the register settings but require standalone operation during run-time. The data and clock lines toggle at power-on or reset to indicate that the device requires setup. After changing the settings and more particularly the user interface option, the device will start operating in the required mode.

In this mode the IQS211A is not recommended to share a bus with other devices. Normal polling may be used, but the master may also monitor the I²C clock line as an indication from the IQS211A that the communications window is open. The clock line therefore serves as a ready line.

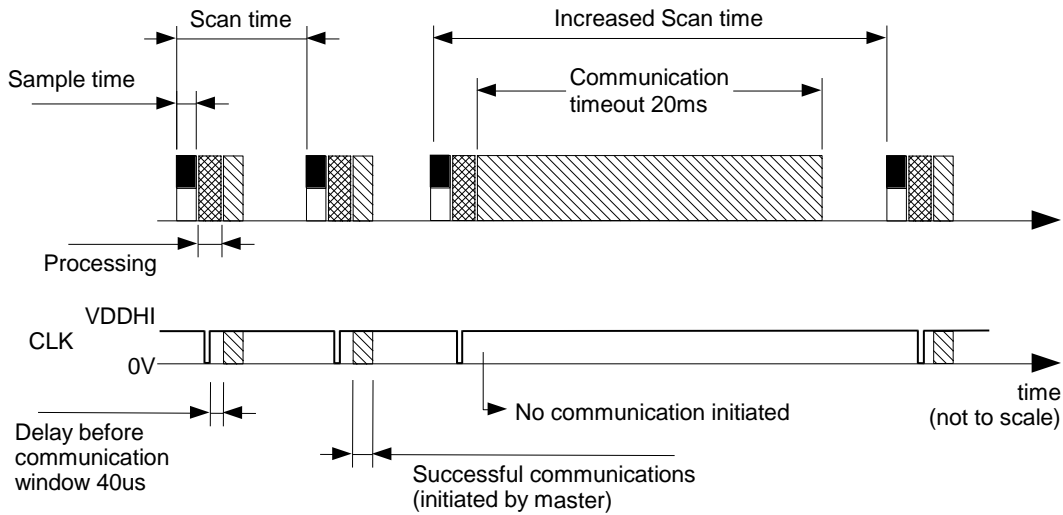

Figure 6-2 How to use RDY signal on clock line

Communications may be initiated at any time from clock low-to-high transition plus 40µs until 20ms thereafter, when the communications window closes. Polling should be done within this time window in order to communicate with the device. If now communications are done the window will time out. If communications are completed with a stop command, the window will close and sampling will continue after a sleep period.

After changing register 0xC7 bits 2:0 (memory map – user interface selection) in this mode, it is required to read any other register in order to activate the chosen user interface (such as a standalone mode) before sending a stop command.

6.3 I²C polling with RDY on clock and wake-up on pin change (111)

This I²C mode is aimed at applications that require the flexibility of I²C settings, but requires wake-up functionality from the master side. A ready indication is also given on the clock line to enable the master to efficiently handle the available communications window.

The wake-up on pin change prevents this configuration from being efficiently used along with other devices on the bus.



7 Specifications

7.1 Absolute maximum ratings

The following absolute maximum parameters are specified for the device:

Exceeding these maximum specifications may cause damage to the device.

- Operating temperature -20°C to 85°C
- Supply Voltage (VDDHI – VSS) 3.6V
- Maximum pin voltage VDDHI + 0.5V (may not exceed VDDHI max)
- Maximum continuous current (for specific Pins) 10mA
- Minimum pin voltage VSS – 0.5V
- Minimum power-on slope 100V/s
- ESD protection ±8kV (Human body model)
- Package Moisture Sensitivity Level (MSL) 1

Table 7.1 IQS211A General Operating Conditions

DESCRIPTION	Conditions	PARAMETER	MIN	TYP	MAX	UNIT
Supply voltage		V _{DDHI}	1.8	3.3V	3.6	V
Internal regulator output	$1.8 \leq V_{DDHI} \leq 3.6$	V _{REG}	1.62	1.7	1.79	V
Default Operating Current	3.3V, Scan time = 9	I _{IQS211DP}		77	88	μA
Low Power Example Setting 1*	3.3V, Scan time =160	I _{IQS211LP160}			2**	μA

*Scan time in ms

**Defined for low target counts (192)

Table 7.2 Start-up and shut-down slope Characteristics

DESCRIPTION	Conditions	PARAMETER	MIN	MAX	UNIT
Power On Reset	V _{DDHI} Slope ≥ 100V/s @25°C	POR	1.2	-	V
Brown Out Detect	V _{DDHI} Slope ≥ 100V/s @25°C	BOD	-	1.5	V

Table 7.3 Input signal response characteristics (IO1/IO2)

DESCRIPTION	MIN	TYP	MAX	UNIT
Reseed function	15	20	25	ms
Halt charge / Reduce sensitivity function	50	n/a	n/a	ms

Table 7.4 Communications timing characteristics

DESCRIPTION	MIN	TYP	MAX	UNIT
t _{comms_timeout}	-	20	-	ms



Table 7.5 Digital input trigger levels

DESCRIPTION	Conditions	PARAMETER	MIN	TYPICAL	MAX	UNIT
All digital inputs	VDD = 3.3V	Input low level voltage	1.19	1.3	1.3	V
All digital inputs	VDD = 1.8V	Input low level voltage	0.54	0.6	0.76	V
All digital inputs	VDD = 1.8V	Input high level voltage	0.9	1.0	1.2	V
All digital inputs	VDD = 3.3V	Input high level voltage	1.90	2.1	2.20	V

8 Package information

8.1 TSOT23-6

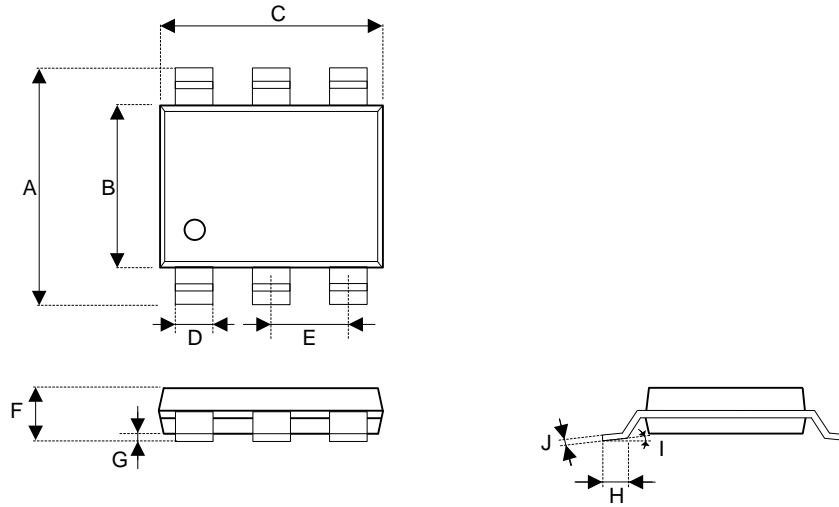

Figure 8-1 TSOT23-6 Packagingⁱ

Table 8.1 TSOT23-6 Dimensions

Dimension	Min (mm)	Max (mm)
A	2.60	3.00
B	1.50	1.70
C	2.80	3.00
D	0.30	0.50
E	0.95 Basic	
F	0.84	1.00
G	0.00	0.10
H	0.30	0.50
I	0°	8°
J	0.03	0.20

ⁱ Drawing not on Scale



8.2 MSL Level

Moisture Sensitivity Level (MSL) relates to the packaging and handling precautions for some semiconductors. The MSL is an electronic standard for the time period in which a moisture sensitive device can be exposed to ambient room conditions (approximately 30°C/85%RH see J-STD033C for more info) before reflow occur.

Package	Level (duration)
TSOT23-6	MSL 1 (Unlimited at ≤30 °C/85% RH) Reflow profile peak temperature < 260 °C for < 30 seconds



9 Ordering and Part-number Information

9.1 Ordering Information

Please check stock availability with your local distributor.

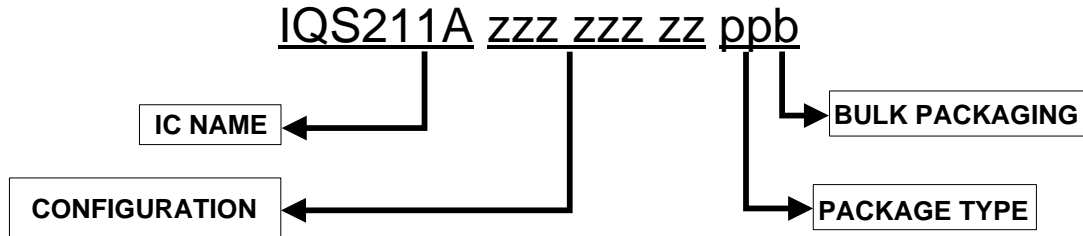

IC NAME	IQS211A	=	Self Capacitive Touch IC
CONFIGURATION	zzz zzz zz	=	IC configuration (hexadecimal) Default: 000 000 00 (other configurations available on request) sub-2uA: 382 028 95
PACKAGE TYPE	TS	=	TSOT23-6 package
BULK PACKAGING	R	=	Reel (3000pcs/reel) – MOQ = 3000pcs MOQ = 1 reel (orders shipped as full reels)

9.2 Label Information

REVISION	x	=	IC Revision Number
TEMPERATURE RANGE	t	=	-20°C to 85°C (Industrial)
DATE CODE	P	=	Internal use
	WWYY=	=	Batch number

9.3 Device Marking – Top

There are 2 marking versions for IQS211A:

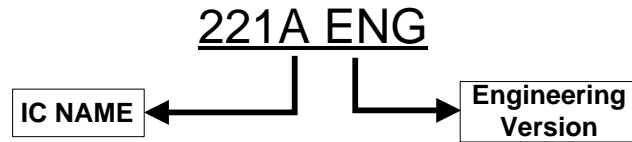

Figure 9-1 IQS211A engineer version, marked as 221A.

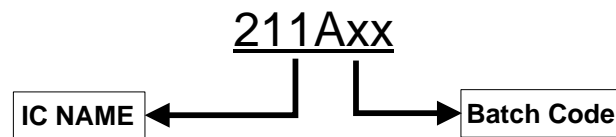

Figure 9-2 Production version marking of IQS211A.

IC NAME	221A ENG	=	IQS211A Engineering version
	211A	=	IQS211A Production version
Batch Code	xx	=	AA to ZZ

9.4 Device Marking - Bottom

Some batches IQS211A will not have any bottom markings. These devices are configured after marking, and may have variations in configuration – please refer to the reel label.

Other batches will display the version and unique product code on the chip on the bottom marking.

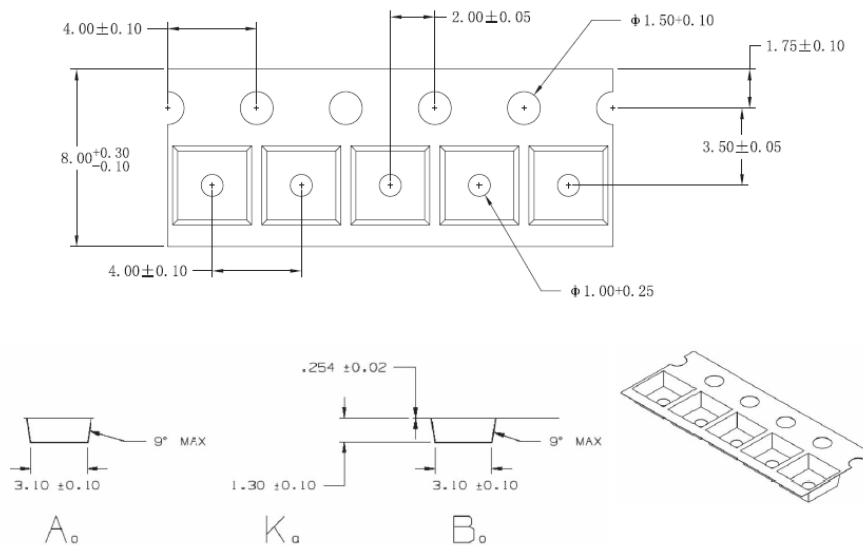

NOTE:
1. Material is PC;
2. Material : 3000.

TSOT23-6 Tape Specification



Revision History

Revision Number	Description	Date of issue
V0.9	IQS211A preliminary datasheet	23 November 2015
V1.0	First release	December 2015
V1.01	Updated Ordering information and Marking	December 2015
V1.10	Latch-up prevention details added	September 2016
V1.2	Temperature range updated	28 September 2017
V1.3	Datasheet extended with relevant information	28 February 2018



Contact Information

	USA	Asia	South Africa
Physical Address	6507 Jester Blvd Bldg 5, suite 510G Austin TX 78750 USA	Rm2125, Glittery City Shennan Rd Futian District Shenzhen, 518033 China	109 Main Street Paarl 7646 South Africa
Postal Address	6507 Jester Blvd Bldg 5, suite 510G Austin TX 78750 USA	Rm2125, Glittery City Shennan Rd Futian District Shenzhen, 518033 China	PO Box 3534 Paarl 7620 South Africa
Tel	+1 512 538 1995	+86 755 8303 5294 ext 808	+27 21 863 0033
Fax	+1 512 672 8442		+27 21 863 1512
Email	info@azoteq.com	info@azoteq.com	info@azoteq.com

Please visit www.azoteq.com for a list of distributors and worldwide representation.

The following patents relate to the device or usage of the device: US 6,249,089; US 6,952,084; US 6,984,900; US 7,084,526; US 7,084,531; US 8,395,395; US 8,531,120; US 8,659,306; US 8,823,273; US 9,209,803; US 9,360,510; US 9,496,793; US 9,709,614; EP 2,351,220; EP 2,559,164; EP 2,748,927; EP 2,846,465; HK 1,157,080; SA 2001/2151; SA 2006/05363; SA 2014/01541; SA 2015/023634; SA 2017/02224;

AirButton®, Azoteq®, Crystal Driver®, IQ Switch®, ProxSense®, ProxFusion®, LightSense™, SwipeSwitch™, and the  logo are trademarks of Azoteq.

The information in this Datasheet is believed to be accurate at the time of publication. Azoteq uses reasonable effort to maintain the information up-to-date and accurate, but does not warrant the accuracy, completeness or reliability of the information contained herein. All content and information are provided on an "as is" basis only, without any representations or warranties, express or implied, of any kind, including representations about the suitability of these products or information for any purpose. Azoteq disclaims all warranties and conditions with regard to these products and information, including but not limited to all implied warranties and conditions of merchantability, fitness for a particular purpose, title and non-infringement of any third party intellectual property rights. Azoteq assumes no liability for any damages or injury arising from any use of the information or the product or caused by, without limitation, failure of performance, error, omission, interruption, defect, delay in operation or transmission, even if Azoteq has been advised of the possibility of such damages. The applications mentioned herein are used solely for the purpose of illustration and Azoteq makes no warranty or representation that such applications will be suitable without further modification, nor recommends the use of its products for application that may present a risk to human life due to malfunction or otherwise. Azoteq products are not authorized for use as critical components in life support devices or systems. No licenses to patents are granted, implicitly, express or implied, by estoppel or otherwise, under any intellectual property rights. In the event that any of the abovementioned limitations or exclusions does not apply, it is agreed that Azoteq's total liability for all losses, damages and causes of action (in contract, tort (including without limitation, negligence) or otherwise) will not exceed the amount already paid by the customer for the products. Azoteq reserves the right to alter its products, to make corrections, deletions, modifications, enhancements, improvements and other changes to the content and information, its products, programs and services at any time or to move or discontinue any contents, products, programs or services without prior notification. For the most up-to-date information and binding Terms and Conditions please refer to www.azoteq.com.

www.azoteq.com/ip

info@azoteq.com

Looking for pricing, stock, or lifecycle information?

Click below to explore more details on WIN SOURCE:

- [View IQS211A-00000000-TSR on WIN SOURCE](#)
- [Azoteq \(Pty\) Ltd Information](#)

Optimize Your Supply Chain with WIN SOURCE Solutions

- ✓ Global Sourcing Solution
- ✓ Obsolete Management
- ✓ Cost Control Management
- ✓ Shortage Management
- ✓ Alternative Solution
- ✓ Excess Inventory Management