



**THE DATASHEET OF  
IRF7421D1TR**



# IRF7421D1

FETKY™ MOSFET / Schottky Diode

- Co-packaged HEXFET® Power MOSFET and Schottky Diode
- Ideal For Synchronous Regulator Applications
- Generation V Technology
- SO-8 Footprint

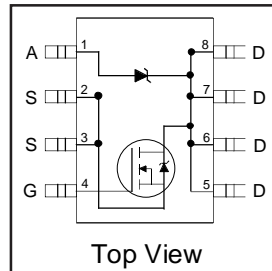

$V_{DSS} = 30V$
$R_{DS(on)} = 0.035\Omega$
Schottky Vf = 0.39V

## Description

The FETKY™ family of co-packaged HEXFETs and Schottky diodes offer the designer an innovative board space saving solution for switching regulator applications. Generation 5 HEXFETs utilize advanced processing techniques to achieve extremely low on-resistance per silicon area. Combining this technology with International Rectifier's low forward drop Schottky rectifiers results in an extremely efficient device suitable for use in a wide variety of portable electronics applications.

The SO-8 has been modified through a customized leadframe for enhanced thermal characteristics. The SO-8 package is designed for vapor phase, infrared or wave soldering techniques.

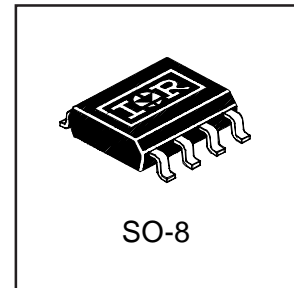

## Absolute Maximum Ratings (T<sub>A</sub> = 25°C unless otherwise noted)

Parameter		Maximum	Units
I <sub>D</sub> @ T <sub>A</sub> = 25°C	Continuous Drain Current, V <sub>GS</sub> @10V <sup>④</sup>	5.8	A
I <sub>D</sub> @ T <sub>A</sub> = 70°C		4.6	
I <sub>DM</sub>	Pulsed Drain Current <sup>①</sup>	46	
P <sub>D</sub> @ T <sub>A</sub> = 25°C	Power Dissipation <sup>④</sup>	2.0	W
P <sub>D</sub> @ T <sub>A</sub> = 70°C		1.3	
	Linear Derating Factor	16	W/°C
V <sub>GS</sub>	Gate-to-Source Voltage	± 20	V
dv/dt	Peak Diode Recovery dv/dt <sup>②</sup>	-5.0	V/ns
T <sub>J</sub> , T <sub>STG</sub>	Junction and Storage Temperature Range	-55 to +150	°C

## Thermal Resistance Ratings

Parameter		Maximum	Units
R <sub>θJA</sub>	Junction-to-Ambient <sup>④</sup>	62.5	°C/W

### Notes:

- ① Repetitive rating; pulse width limited by maximum junction temperature (see figure 11)
- ② I<sub>SD</sub> ≤ 4.1A, di/dt ≤ 110A/μs, V<sub>DD</sub> ≤ V<sub>(BR)DSS</sub>, T<sub>J</sub> ≤ 150°C
- ③ Pulse width ≤ 300μs; duty cycle ≤ 2%
- ④ Surface mounted on FR-4 board, t ≤ 10sec.

**MOSFET Electrical Characteristics @ T<sub>J</sub> = 25°C (unless otherwise specified)**

Parameter		Min.	Typ.	Max.	Units	Conditions
V <sub>(BR)DSS</sub>	Drain-to-Source Breakdown Voltage	30	—	—	V	V <sub>GS</sub> = 0V, I <sub>D</sub> = 250μA
R <sub>DS(on)</sub>	Static Drain-to-Source On-Resistance	—	0.026	0.035	Ω	V <sub>GS</sub> = 10V, I <sub>D</sub> = 4.1A ③
		—	0.040	0.060		V <sub>GS</sub> = 4.5V, I <sub>D</sub> = 2.1A ③
V <sub>GS(th)</sub>	Gate Threshold Voltage	1.0	—	—	V	V <sub>DS</sub> = V <sub>GS</sub> , I <sub>D</sub> = 250μA
g <sub>fs</sub>	Forward Transconductance	4.6	—	—	S	V <sub>DS</sub> = 15V, I <sub>D</sub> = 2.1A
I <sub>DSS</sub>	Drain-to-Source Leakage Current	—	—	1.0	μA	V <sub>DS</sub> = 24V, V <sub>GS</sub> = 0V
		—	—	25		V <sub>DS</sub> = 24V, V <sub>GS</sub> = 0V, T <sub>J</sub> = 125°C
I <sub>GSS</sub>	Gate-to-Source Forward Leakage	—	—	-100	nA	V <sub>GS</sub> = -20V
	Gate-to-Source Reverse Leakage	—	—	100		V <sub>GS</sub> = 20V
Q <sub>g</sub>	Total Gate Charge	—	18	27	nC	I <sub>D</sub> = 4.1A
Q <sub>gs</sub>	Gate-to-Source Charge	—	2.2	3.3		V <sub>DS</sub> = 24V
Q <sub>gd</sub>	Gate-to-Drain ("Miller") Charge	—	5.9	8.9		V <sub>GS</sub> = 10V (see figure 10) ③
t <sub>d(on)</sub>	Turn-On Delay Time	—	6.7	—		V <sub>DD</sub> = 15V
t <sub>r</sub>	Rise Time	—	27	—	ns	I <sub>D</sub> = 4.1A
t <sub>d(off)</sub>	Turn-Off Delay Time	—	20	—		R <sub>G</sub> = 6.2Ω
t <sub>f</sub>	Fall Time	—	16	—		R <sub>D</sub> = 3.7Ω ③
C <sub>iss</sub>	Input Capacitance	—	510	—		V <sub>GS</sub> = 0V
C <sub>oss</sub>	Output Capacitance	—	200	—	pF	V <sub>DS</sub> = 25V
C <sub>riss</sub>	Reverse Transfer Capacitance	—	84	—		f = 1.0MHz (see figure 9)

**MOSFET Source-Drain Ratings and Characteristics**

Parameter		Min.	Typ.	Max.	Units	Conditions
I <sub>S</sub>	Continuous Source Current (Body Diode)	—	—	3.1	A	
I <sub>SM</sub>	Pulsed Source Current (Body Diode)	—	—	33		
V <sub>SD</sub>	Body Diode Forward Voltage	—	—	1.0	V	T <sub>J</sub> = 25°C, I <sub>S</sub> = 4.1A, V <sub>GS</sub> = 0V
t <sub>rr</sub>	Reverse Recovery Time (Body Diode)	—	57	86	ns	T <sub>J</sub> = 25°C, I <sub>F</sub> = 4.1A
Q <sub>rr</sub>	Reverse Recovery Charge	—	93	140	nC	di/dt = 100A/μs ③

**Schottky Diode Maximum Ratings**

	Parameter	Max.	Units	Conditions
I <sub>F(av)</sub>	Max. Average Forward Current	1.7	A	50% Duty Cycle. Rectangular Wave, T <sub>A</sub> = 25°C T <sub>A</sub> = 70°C
		1.2		
I <sub>SM</sub>	Max. peak one cycle Non-repetitive Surge current	120	A	Following any rated load condition & with V <sub>RRM</sub> applied
		11		

**Schottky Diode Electrical Specifications**

	Parameter	Max.	Units	Conditions
V <sub>FM</sub>	Max. Forward voltage drop	0.50	V	I <sub>F</sub> = 1.0A, T <sub>J</sub> = 25°C
		0.62		I <sub>F</sub> = 2.0A, T <sub>J</sub> = 25°C
		0.39		I <sub>F</sub> = 1.0A, T <sub>J</sub> = 125°C
		0.57		I <sub>F</sub> = 2.0A, T <sub>J</sub> = 125°C
I <sub>RM</sub>	Max. Reverse Leakage current	0.06	mA	V <sub>R</sub> = 30V, T <sub>J</sub> = 25°C
		16		T <sub>J</sub> = 125°C
C <sub>t</sub>	Max. Junction Capacitance	110	pF	V <sub>R</sub> = 5Vdc ( 100kHz to 1 MHz) 25°C
dv/dt	Max. Voltage Rate of Charge	3600	V/ μs	Rated V <sub>R</sub>

Power Mosfet Characteristics

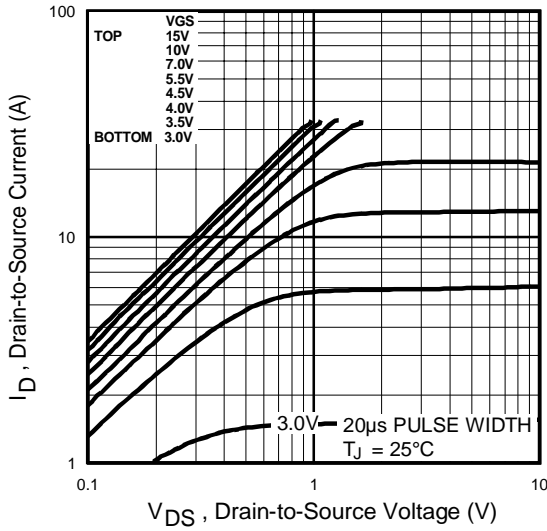

Fig 1. Typical Output Characteristics

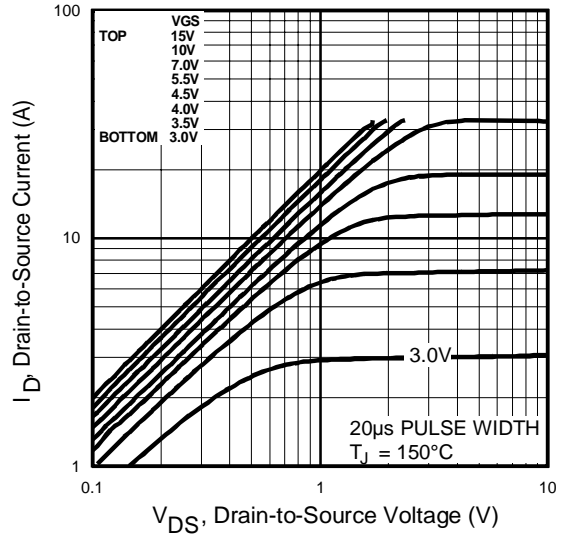

Fig 2. Typical Output Characteristics

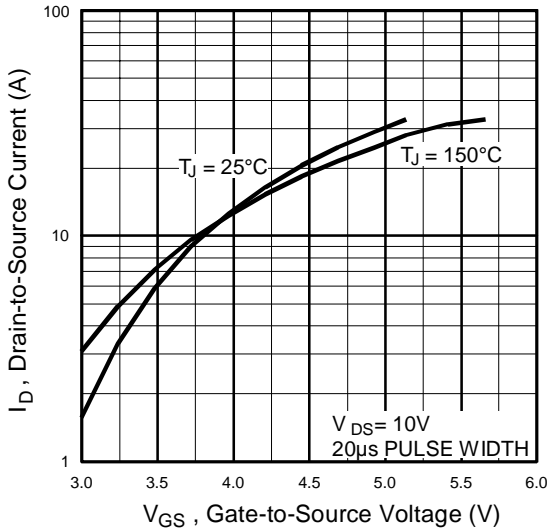

Fig 3. Typical Transfer Characteristics

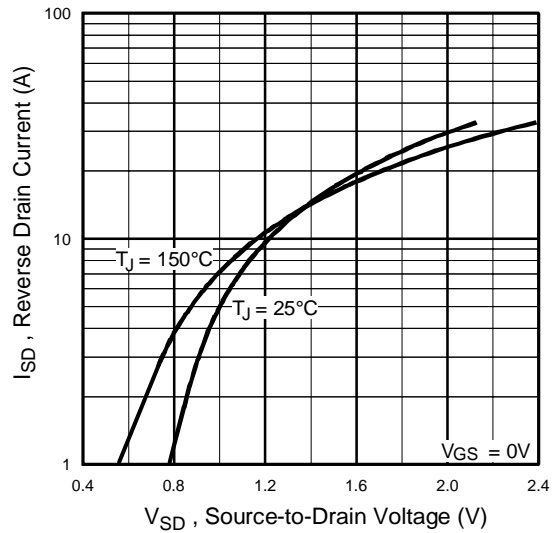

Fig 4. Typical Source-Drain Diode Forward Voltage

Power Mosfet Characteristics

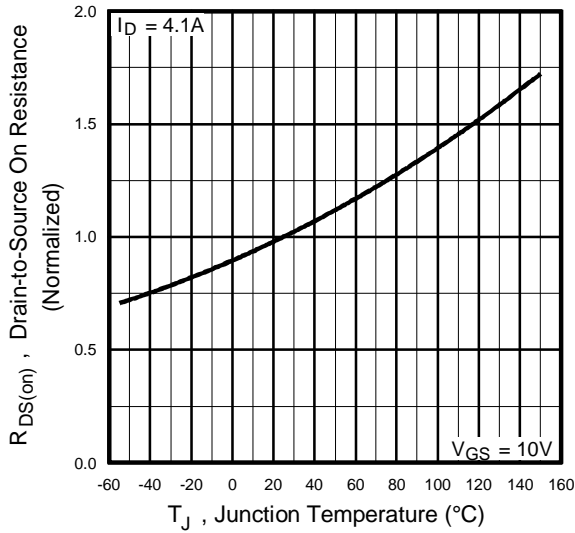

Fig 5. Normalized On-Resistance Vs. Temperature

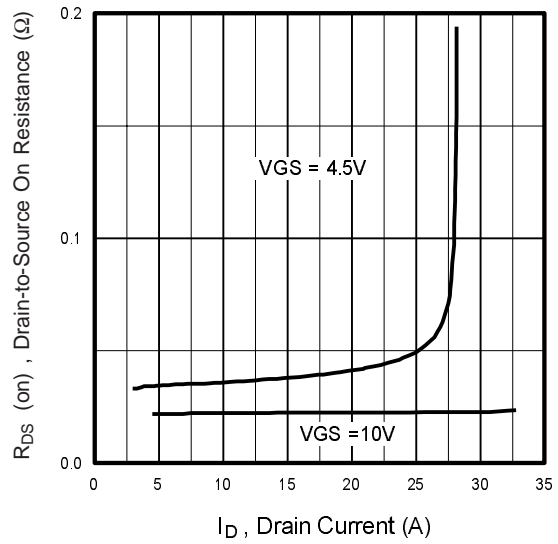

Fig 6. Typical On-Resistance Vs. Drain Current

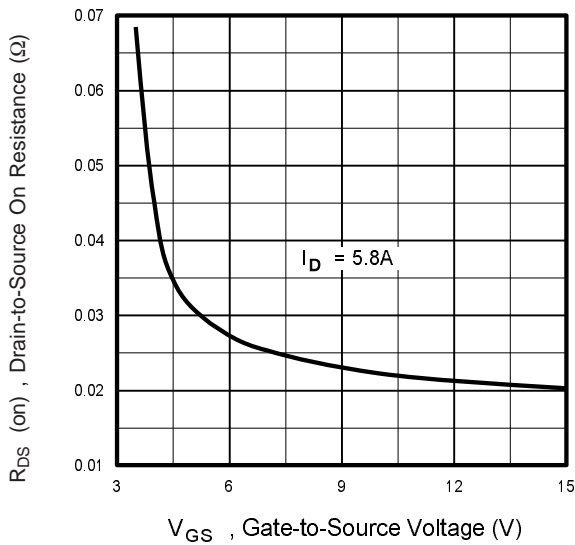

Fig 7. Typical On-Resistance Vs. Gate Voltage

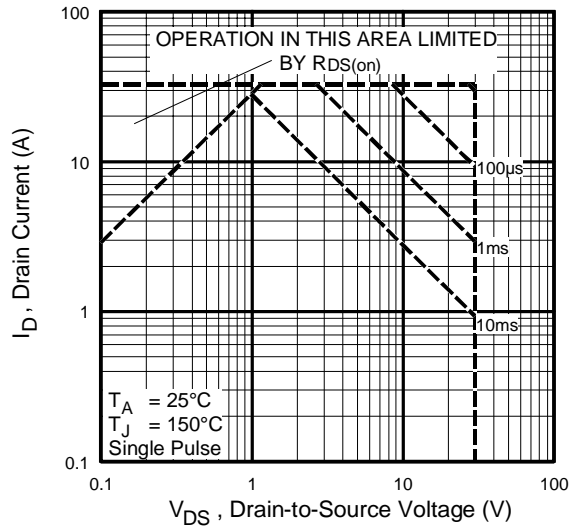

Fig 8. Maximum Safe Operating Area

Power Mosfet Characteristics

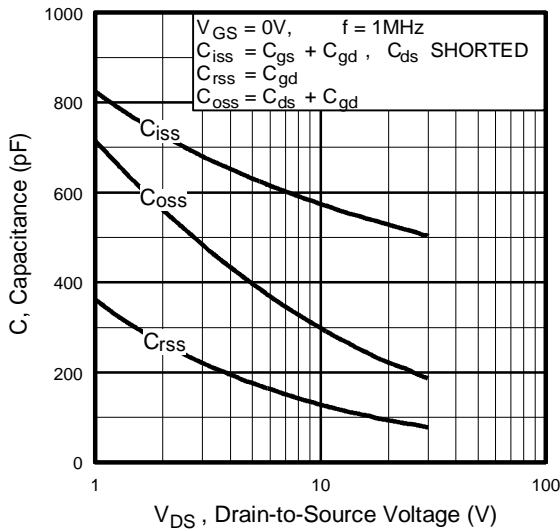

Fig 9. Typical Capacitance Vs. Drain-to-Source Voltage

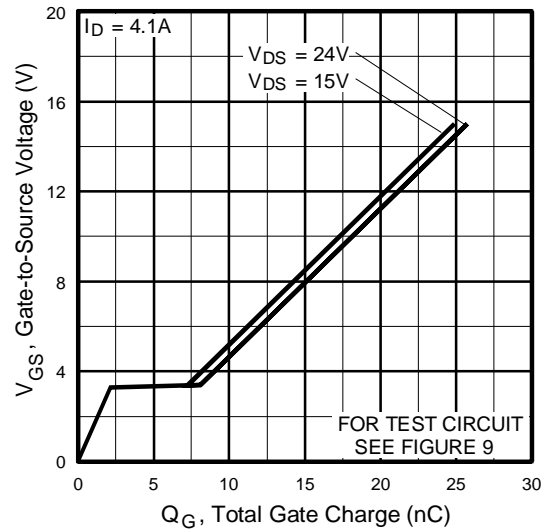

Fig 10. Typical Gate Charge Vs. Gate-to-Source Voltage

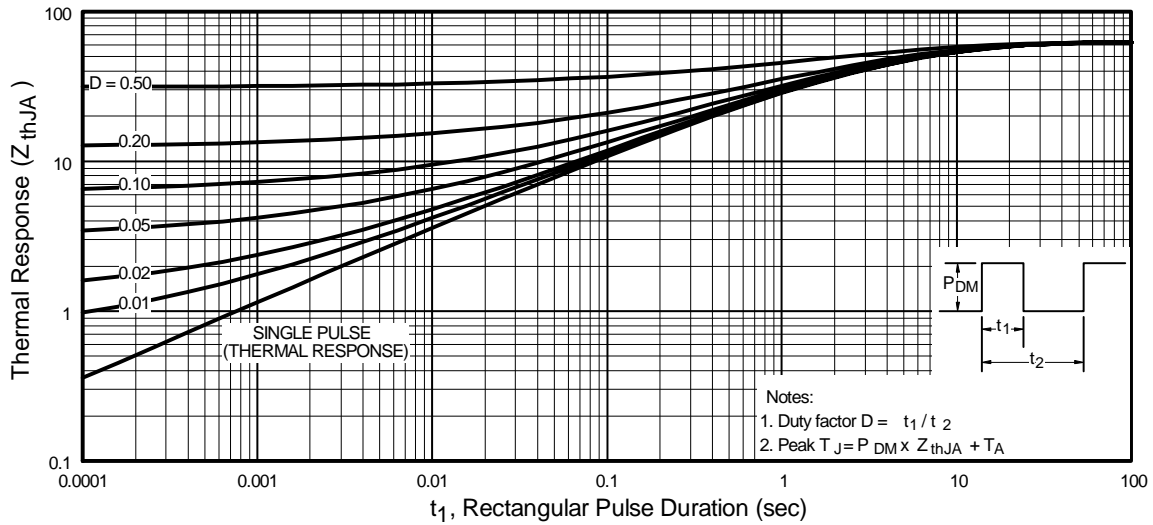

Fig 11. Maximum Effective Transient Thermal Impedance, Junction-to-Ambient

Schottky Diode Characteristics

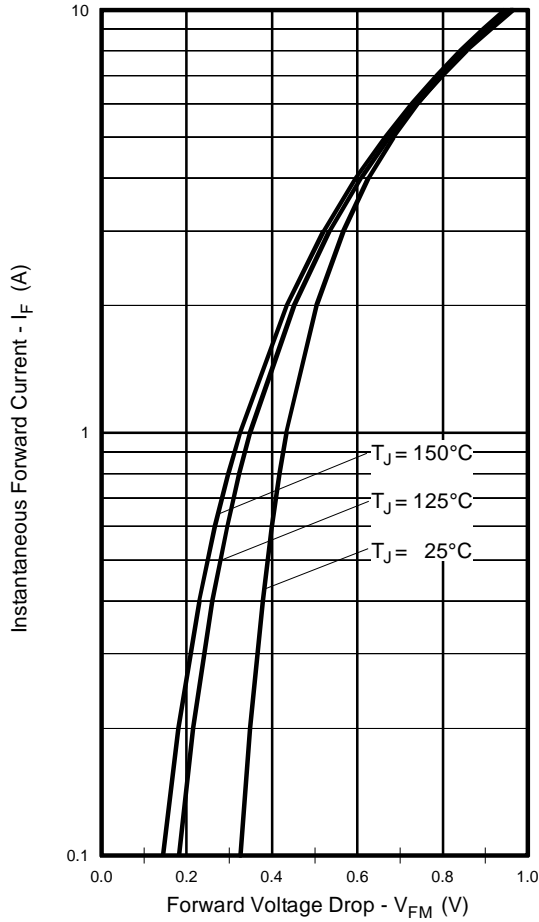

Fig. 12 -Typical Forward Voltage Drop Characteristics

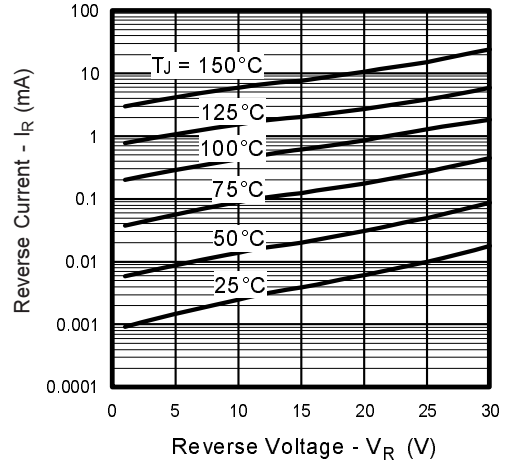

Fig. 13 - Typical Values of Reverse Current Vs. Reverse Voltage

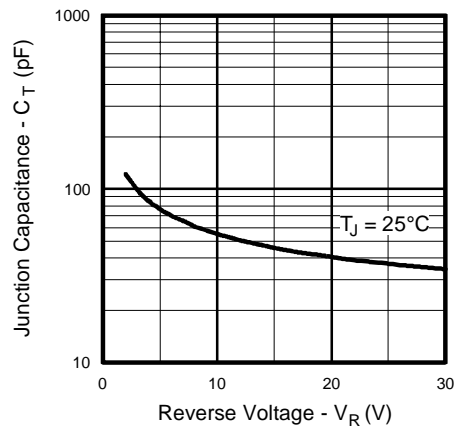
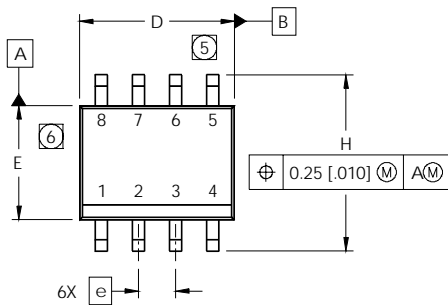

Fig.14 - Typical Junction Capacitance Vs. Reverse Voltage

**SO-8 (Fetky) Package Outline**

Dimensions are shown in millimeters (inches)



DIM	INCHES		MILLIMETERS	
	MIN	MAX	MIN	MAX
A	.0532	.0688	1.35	1.75
A1	.0040	.0098	0.10	0.25
b	.013	.020	0.33	0.51
c	.0075	.0098	0.19	0.25
D	.189	.1968	4.80	5.00
E	.1497	.1574	3.80	4.00
e	.050 BASIC		1.27 BASIC	
e1	.025 BASIC		0.635 BASIC	
H	.2284	.2440	5.80	6.20
K	.0099	.0196	0.25	0.50
L	.016	.050	0.40	1.27
y	0°	8°	0°	8°

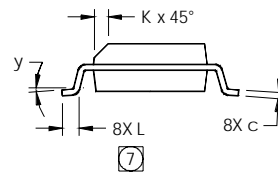
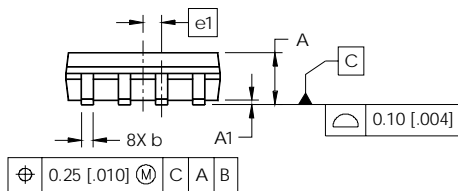

**NOTES:**

1. DIMENSIONING & TOLERANCING PER ASME Y14.5M-1994.
2. CONTROLLING DIMENSION: MILLIMETER
3. DIMENSIONS ARE SHOWN IN MILLIMETERS [INCHES].
4. OUTLINE CONFORMS TO JEDEC OUTLINE MS-012AA.
5. DIMENSION DOES NOT INCLUDE MOLD PROTRUSIONS. MOLD PROTRUSIONS NOT TO EXCEED 0.15 [0.006].
6. DIMENSION DOES NOT INCLUDE MOLD PROTRUSIONS. MOLD PROTRUSIONS NOT TO EXCEED 0.25 [0.010].
7. DIMENSION IS THE LENGTH OF LEAD FOR SOLDERING TO A SUBSTRATE.

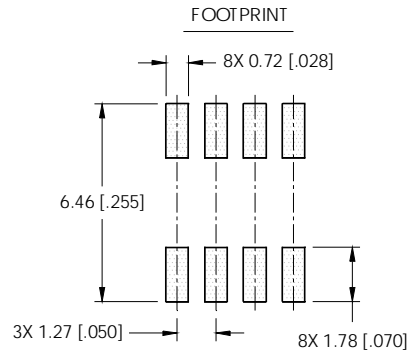

**SO-8 (Fetky) Part Marking Information**

EXAMPLE: THIS IS AN IRF7807D1 (FETKY)

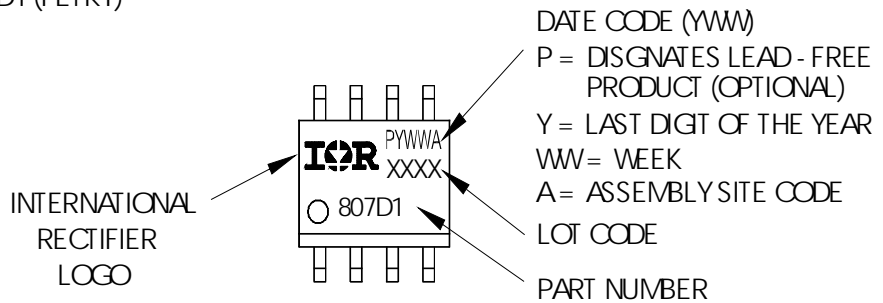

# IRF7421D1

International  
**IR** Rectifier

## SO-8 (Fetky) Tape and Reel

Dimensions are shown in millimeters (inches)

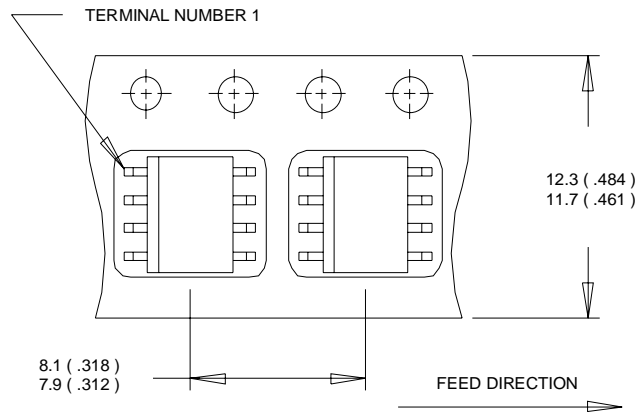

### NOTES:

1. CONTROLLING DIMENSION : MILLIMETER.
2. ALL DIMENSIONS ARE SHOWN IN MILLIMETERS(INCHES).
3. OUTLINE CONFORMS TO EIA-481 & EIA-541.

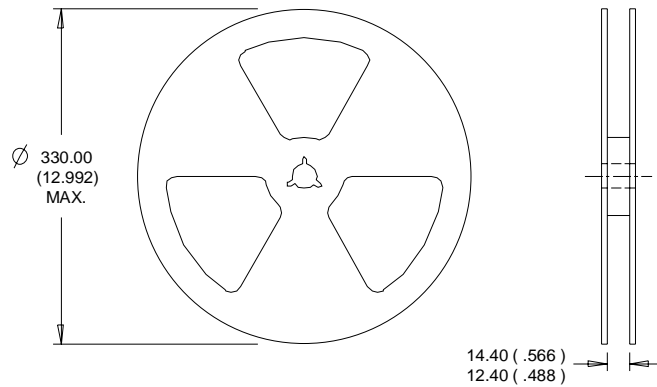

### NOTES :

1. CONTROLLING DIMENSION : MILLIMETER.
2. OUTLINE CONFORMS TO EIA-481 & EIA-541.

Data and specifications subject to change without notice.

International  
**IR** Rectifier

IR WORLD HEADQUARTERS: 233 Kansas St., El Segundo, California 90245, USA Tel: (310) 252-7105  
TAC Fax: (310) 252-7903

Visit us at [www.irf.com](http://www.irf.com) for sales contact information. 10/04

[www.irf.com](http://www.irf.com)

## Looking for pricing, stock, or lifecycle information?

Click below to explore more details on WIN SOURCE:

 [View IRF7421D1TR on WIN SOURCE](#)

 [Infineon Technologies](#) Information

## Optimize Your Supply Chain with WIN SOURCE Solutions

-  Global Sourcing Solution
-  Obsolete Management
-  Cost Control Management
-  Shortage Management
-  Alternative Solution
-  Excess Inventory Management