

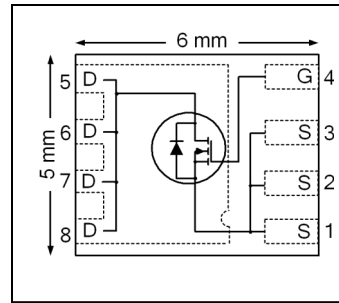

**THE DATASHEET OF
IRFH8201TRPBF**



V_{DSS}	25	V
R_{DS(on)} max (@ V _{GS} = 10V)	0.95	mΩ
(@ V _{GS} = 4.5V)	1.60	
Qg (typical)	56	nC
I_D (@ T _{C (Bottom)} = 25°C)	324	A



Applications

- OR-ing MOSFET for 12V (typical) Bus in-Rush Current
- Battery Operated DC Motor Inverters

Features

Low R _{DS(on)} (<0.95mΩ)
Low Thermal Resistance to PCB (<0.8°C/W)
Low Profile (<0.9 mm)
Industry-Standard Pinout
Compatible with Existing Surface Mount Techniques
RoHS Compliant, Halogen-Free
MSL1, Industrial Qualification

results in
⇒

Benefits

Lower Conduction Losses
Enable better thermal dissipation
Increased Power Density
Multi-Vendor Compatibility
Easier Manufacturing
Environmentally Friendlier
Increased Reliability

Base part number	Package Type	Standard Pack		Orderable Part Number
		Form	Quantity	
IRFH8201PbF	PQFN 5mm x 6 mm	Tape and Reel	4000	IRFH8201TRPbF

Absolute Maximum Ratings

	Parameter	Max.	Units
V _{GS}	Gate-to-Source Voltage	± 20	V
I _D @ T _A = 25°C	Continuous Drain Current, V _{GS} @ 10V	49	A
I _D @ T _{C (Bottom)} = 25°C	Continuous Drain Current, V _{GS} @ 10V ⑤	324	
I _D @ T _{C (Bottom)} = 100°C	Continuous Drain Current, V _{GS} @ 10V ⑤	205	
I _{DM}	Pulsed Drain Current	1296	
P _D @ T _A = 25°C	Power Dissipation ④	3.6	W
P _D @ T _{C (Bottom)} = 25°C	Power Dissipation ④	156	
	Linear Derating Factor ④	0.029	W/°C
T _J T _{STG}	Operating Junction and Storage Temperature Range	-55 to + 150	°C

Notes ① through ⑥ are on page 9

Static @ T_J = 25°C (unless otherwise specified)

	Parameter	Min.	Typ.	Max.	Units	Conditions
BV _{DSS}	Drain-to-Source Breakdown Voltage	25	—	—	V	V _{GS} = 0V, I _D = 250μA
ΔBV _{DSS} /ΔT _J	Breakdown Voltage Temp. Coefficient	—	20	—	mV/°C	Reference to 25°C, I _D = 1mA
R _{DS(on)}	Static Drain-to-Source On-Resistance	—	0.80	0.95	mΩ	V _{GS} = 10V, I _D = 50A ②
		—	1.20	1.60		V _{GS} = 4.5V, I _D = 50A ②
V _{GS(th)}	Gate Threshold Voltage	1.35	1.80	2.35	V	V _{DS} = V _{GS} , I _D = 150μA
ΔV _{GS(th)}	Gate Threshold Voltage Coefficient	—	-6.1	—	mV/°C	
I _{DSS}	Drain-to-Source Leakage Current	—	—	1.0	μA	V _{DS} = 20V, V _{GS} = 0V
		—	—	150		V _{DS} = 20V, V _{GS} = 0V, T _J = 125°C
I _{GSS}	Gate-to-Source Forward Leakage	—	—	100	nA	V _{GS} = 20V
	Gate-to-Source Reverse Leakage	—	—	-100		V _{GS} = -20V
g _{fs}	Forward Transconductance	181	—	—	S	V _{DS} = 10V, I _D = 50A
Q _g	Total Gate Charge	—	111	—	nC	V _{GS} = 10V, V _{DS} = 13V, I _D = 50A
Q _g	Total Gate Charge	—	56	84	nC	V _{DS} = 13V V _{GS} = 4.5V I _D = 50A
Q _{gs1}	Pre-V _{th} Gate-to-Source Charge	—	16	—		
Q _{gs2}	Post-V _{th} Gate-to-Source Charge	—	7.0	—		
Q _{gd}	Gate-to-Drain Charge	—	18	—		
Q _{godr}	Gate Charge Overdrive	—	15	—		
Q _{sw}	Switch Charge (Q _{gs2} + Q _{gd})	—	25	—	nC	
Q _{oss}	Output Charge	—	39	—	nC	V _{DS} = 16V, V _{GS} = 0V
R _G	Gate Resistance	—	1.1	—	Ω	
t _{d(on)}	Turn-On Delay Time	—	27	—	ns	V _{DD} = 13V, V _{GS} = 4.5V I _D = 50A R _G = 4.7Ω
t _r	Rise Time	—	54	—		
t _{d(off)}	Turn-Off Delay Time	—	31	—		
t _f	Fall Time	—	22	—		
C _{iss}	Input Capacitance	—	7330	—	pF	V _{GS} = 0V V _{DS} = 13V f = 1.0MHz
C _{oss}	Output Capacitance	—	1730	—		
C _{rss}	Reverse Transfer Capacitance	—	850	—		

Avalanche Characteristics

	Parameter	Typ.	Max.	Units
E _{AS}	Single Pulse Avalanche Energy ①	—	437	mJ

Diode Characteristics

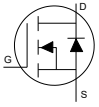
	Parameter	Min.	Typ.	Max.	Units	Conditions
I _S	Continuous Source Current (Body Diode)	—	—	156	A	MOSFET symbol showing the integral reverse p-n junction diode. 
I _{SM}	Pulsed Source Current (Body Diode)	—	—	1296		
V _{SD}	Diode Forward Voltage	—	—	1.0	V	T _J = 25°C, I _S = 50A, V _{GS} = 0V ②
t _{rr}	Reverse Recovery Time	—	25	38	ns	T _J = 25°C, I _F = 50A, V _{DD} = 13V
Q _{rr}	Reverse Recovery Charge	—	57	86	nC	di/dt = 400A/μs ②

Thermal Resistance

	Parameter	Typ.	Max.	Units
R _{θJC} (Bottom)	Junction-to-Case ③	0.5	0.8	°C/W
R _{θJC} (Top)	Junction-to-Case ③	—	21	
R _{θJA}	Junction-to-Ambient ④	—	35	
R _{θJA} (<10s)	Junction-to-Ambient ④	—	20	

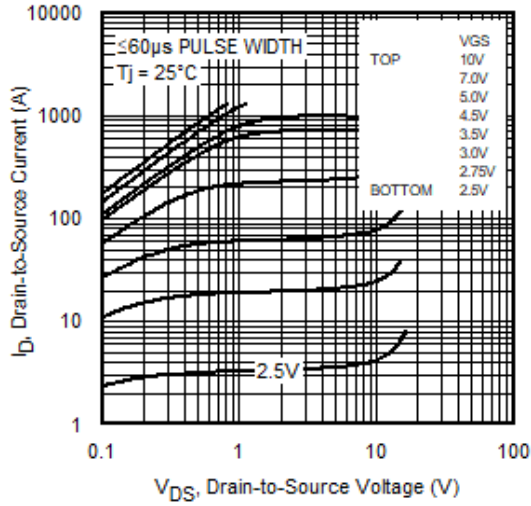

Fig 1. Typical Output Characteristics

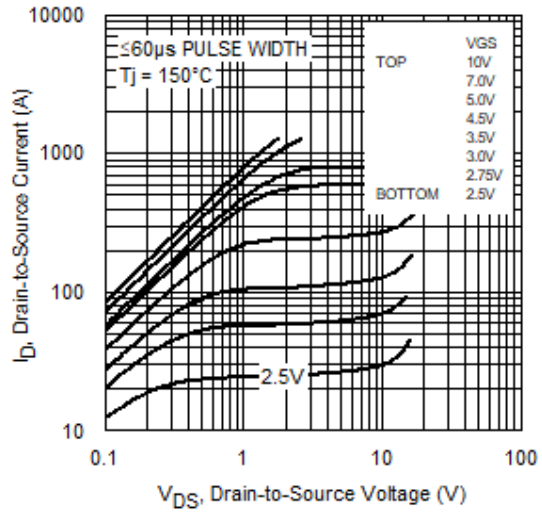

Fig 2. Typical Output Characteristics

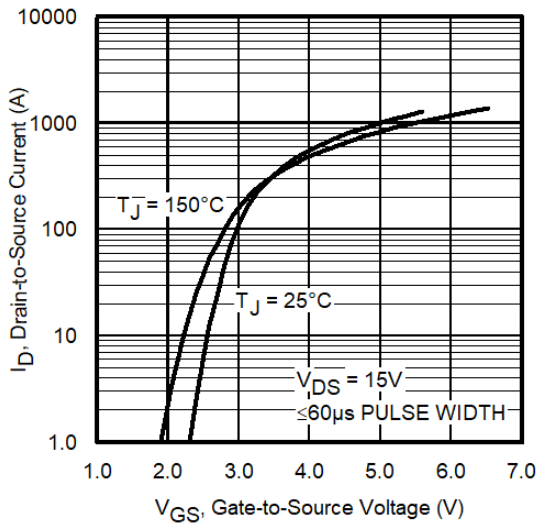

Fig 3. Typical Transfer Characteristics

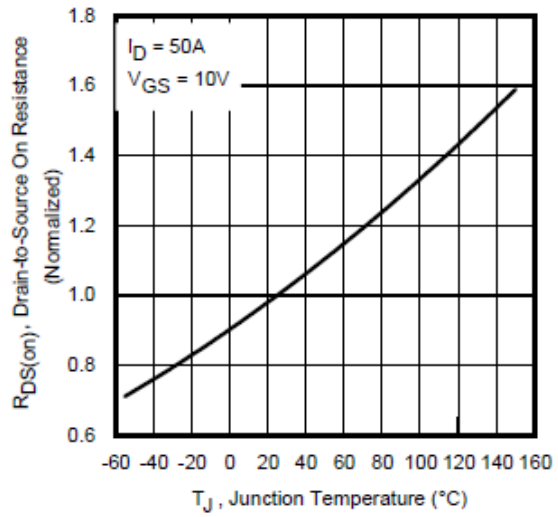

Fig 4. Normalized On-Resistance vs. Temperature

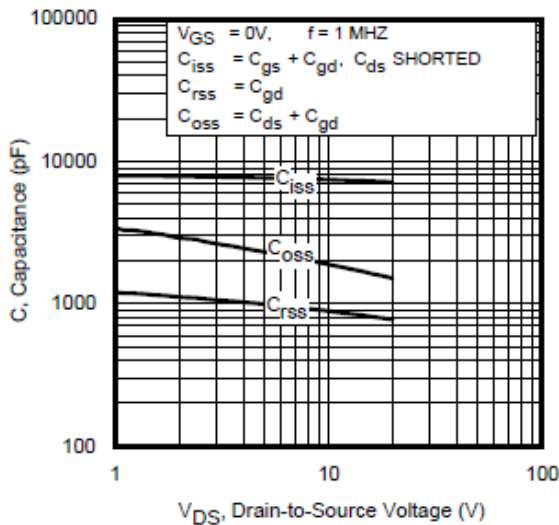

Fig 5. Typical Capacitance vs. Drain-to-Source Voltage

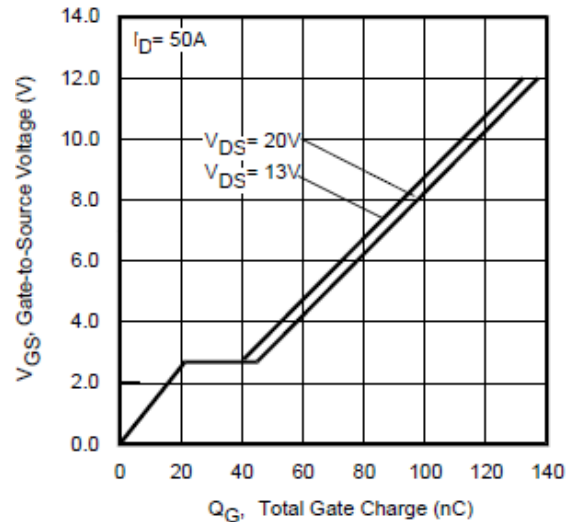

Fig 6. Typical Gate Charge vs. Gate-to-Source Voltage

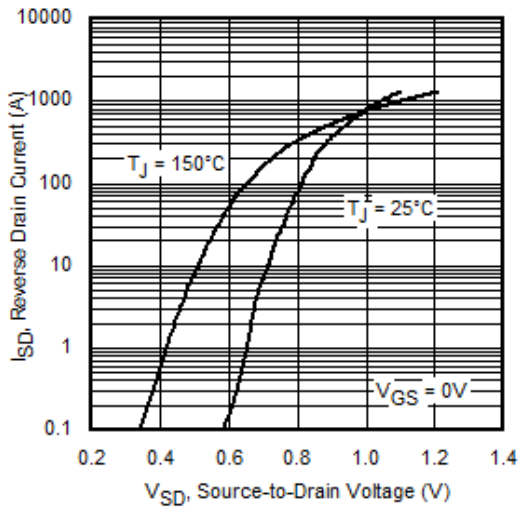

Fig 7. Typical Source-Drain Diode Forward Voltage

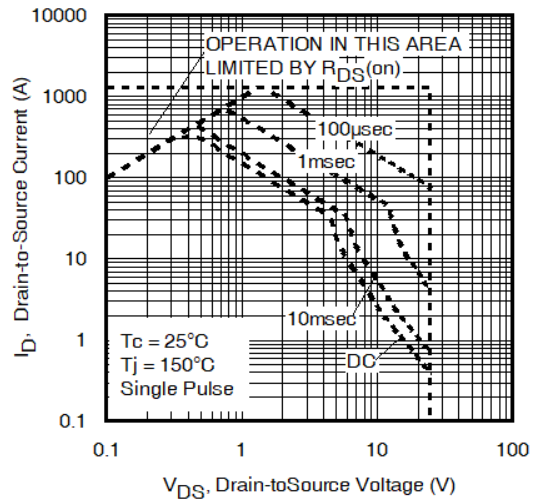

Fig 8. Maximum Safe Operating Area

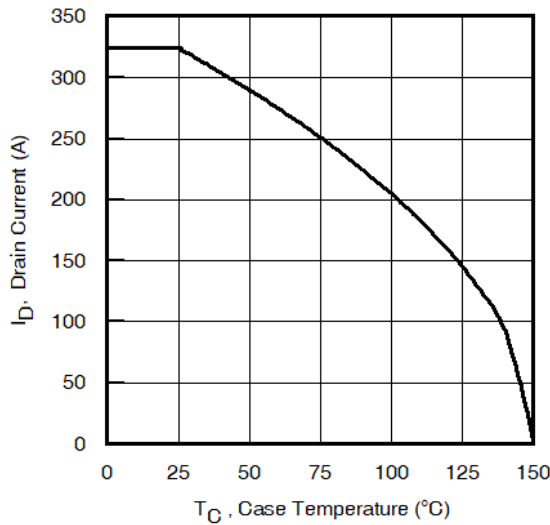

Fig 9. Maximum Drain Current vs. Case Temperature

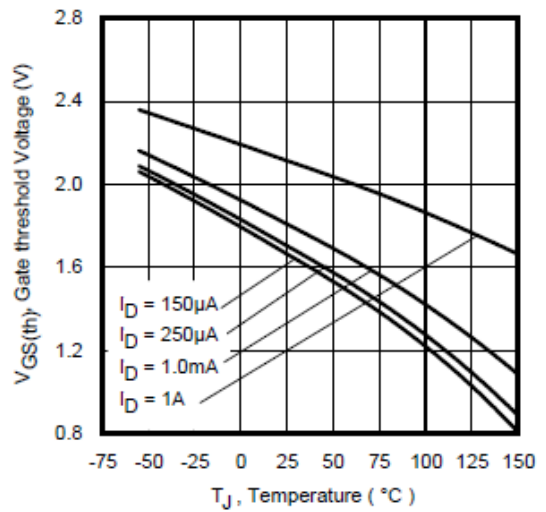

Fig 10. Threshold Voltage Vs. Temperature

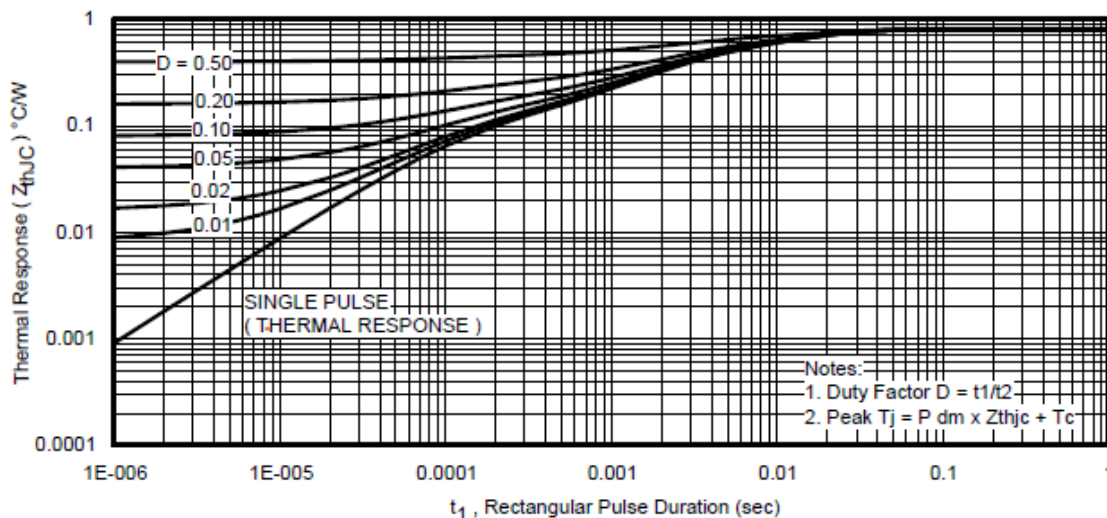

Fig 11. Maximum Effective Transient Thermal Impedance, Junction-to-Case

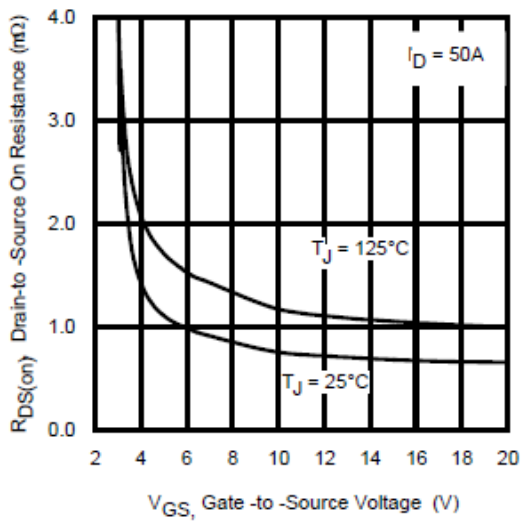

Fig 12. On-Resistance vs. Gate Voltage

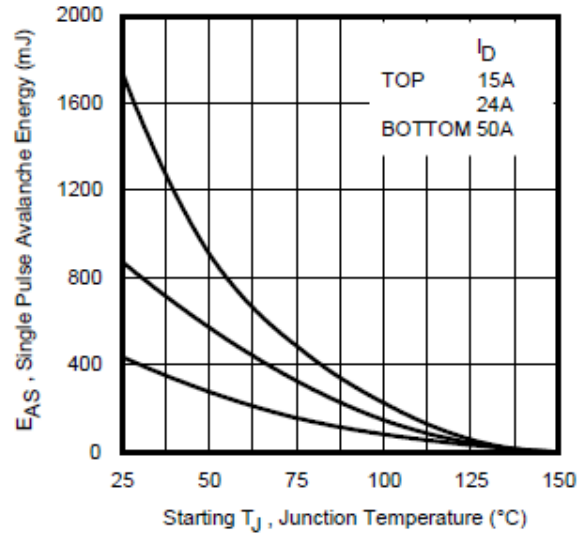

Fig 13. Maximum Avalanche Energy vs. Drain Current

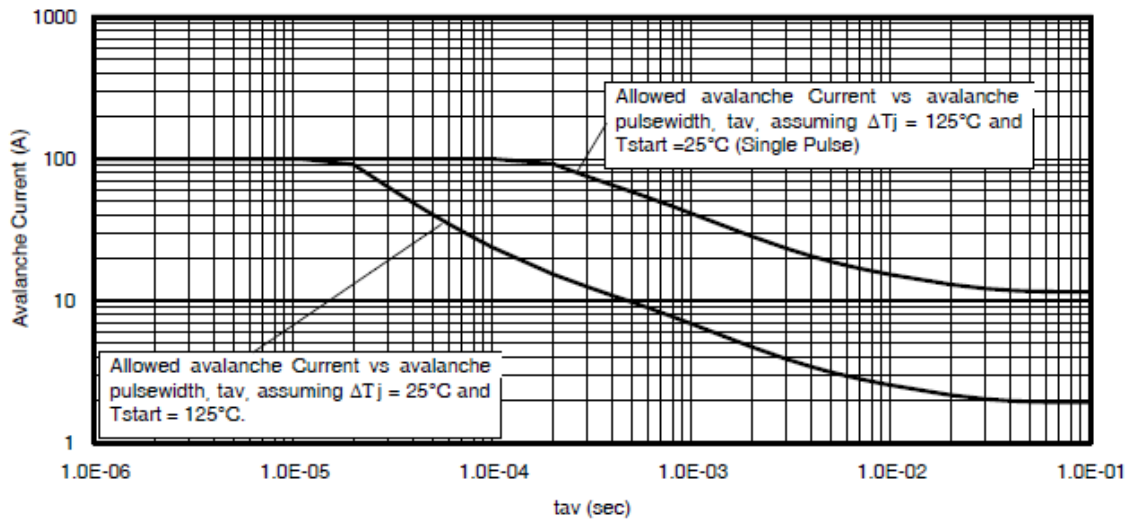
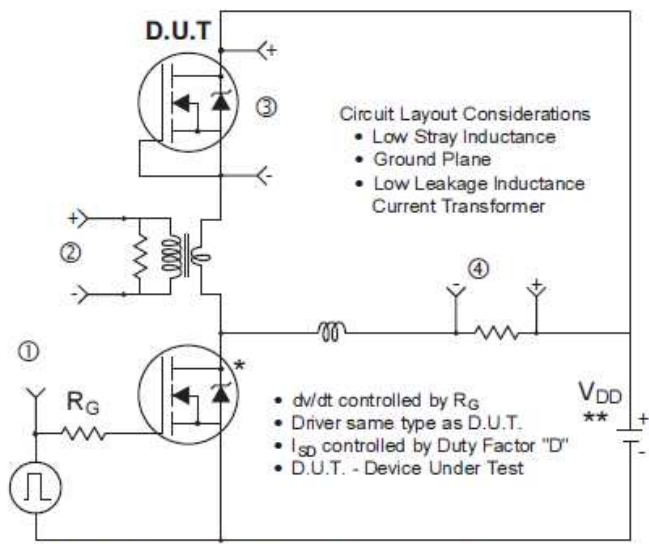

Fig 14. Single Avalanche Event: Pulse Current vs. Pulse Width



- Circuit Layout Considerations**
- Low Stray Inductance
 - Ground Plane
 - Low Leakage Inductance
 - Current Transformer

- dv/dt controlled by R_G
- Driver same type as D.U.T.
- I_{SD} controlled by Duty Factor "D"
- D.U.T. - Device Under Test

* Use P-Channel Driver for P-Channel Measurements
 ** Reverse Polarity for P-Channel

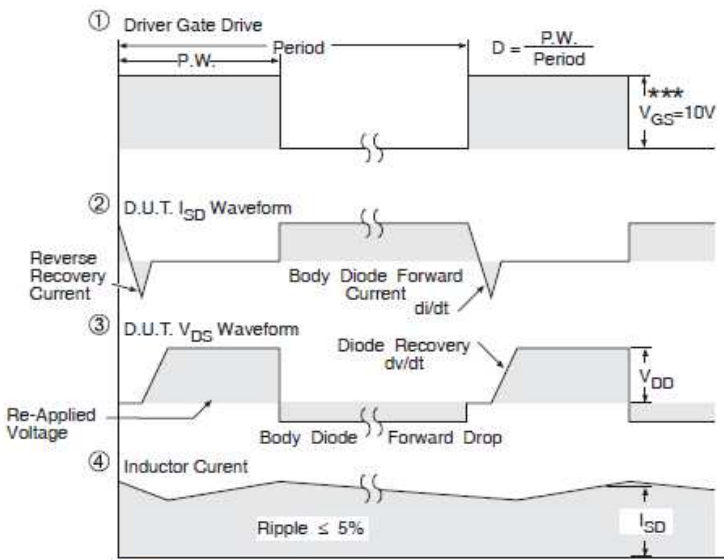

*** $V_{GS} = 5V$ for Logic Level Devices

Fig 15. Peak Diode Recovery dv/dt Test Circuit for N-Channel HEXFET® Power MOSFETs

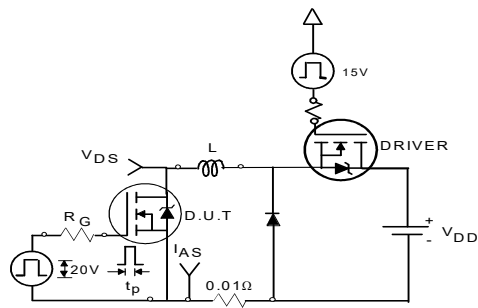

Fig 16a. Unclamped Inductive Test Circuit

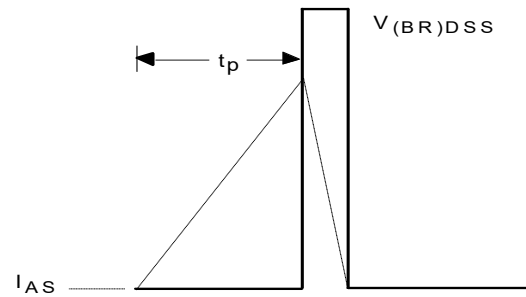

Fig 16b. Unclamped Inductive Waveforms

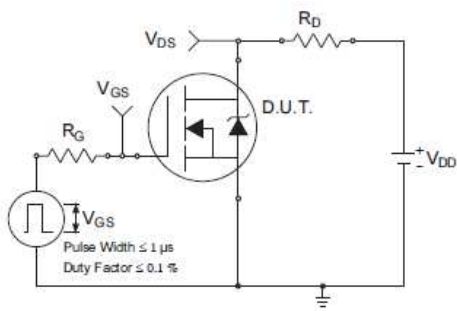

Fig 17a. Switching Time Test Circuit

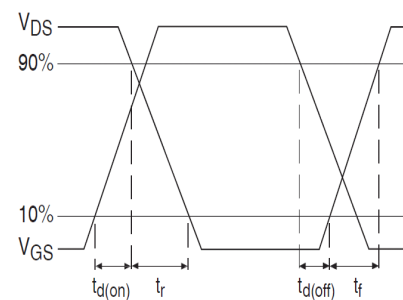

Fig 17b. Switching Time Waveforms

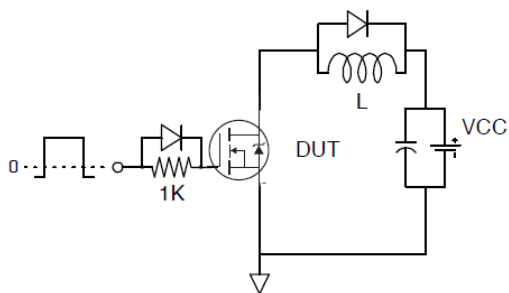

Fig 18a. Gate Charge Test Circuit

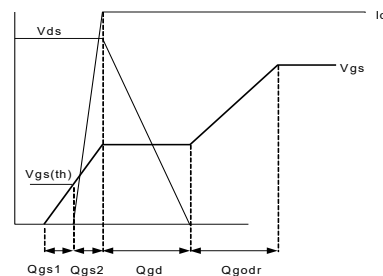
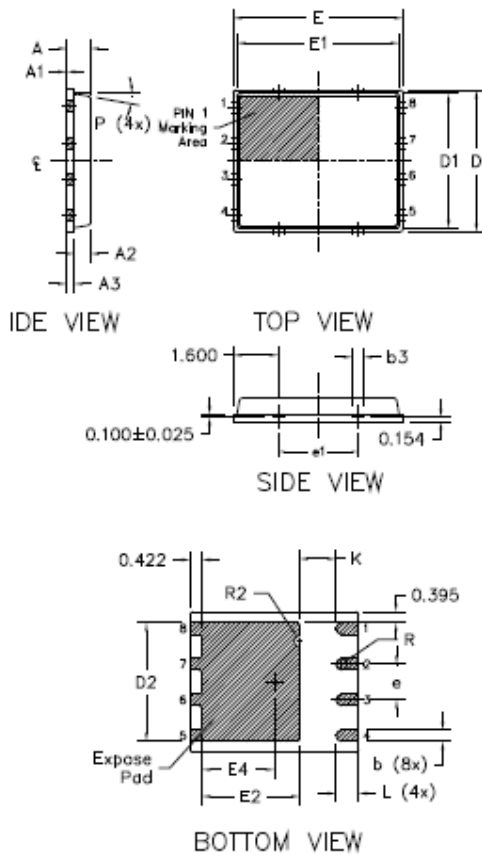

Fig 18b. Gate Charge Waveform

PQFN 5x6 Outline "B" Package Details



DIM SYMBOL	MILLIMETERS		INCH	
	MIN	MAX	MIN	MAX
A	0.800	0.900	0.0315	0.0543
A1	0.000	0.050	0.0000	0.0020
A3	0.200 REF		0.0079 REF	
b	0.350	0.470	0.0138	0.0185
b1	0.025	0.125	0.0010	0.0049
b2	0.210	0.410	0.0083	0.0161
b3	0.150	0.450	0.0059	0.0177
D	5.000 BSC		0.1969 BSC	
D1	4.750 BSC		0.1870 BSC	
D2	4.100	4.300	0.1614	0.1693
E	6.000 BSC		0.2362 BSC	
E1	5.750 BSC		0.2264 BSC	
E2	3.380	3.780	0.1331	0.1488
e	1.270 REF		0.0500 REF	
e1	2.800 REF		0.1102 REF	
K	1.200	1.420	0.0472	0.0559
L	0.710	0.900	0.0280	0.0354
P	0° 12°		0° 12°	
R	0.200 REF		0.0079 REF	
R2	0.150	0.200	0.0059	0.0079

- Note:**
1. Dimensions and tolerancing confirm to ASME Y14.5M-1994
 2. Dimension L represents terminal full back from package edge up to 0.1mm is acceptable
 3. Coplanarity applies to the expose Heat Slug as well as the terminal
 4. Radius on terminal is Optional

For more information on board mounting, including footprint and stencil recommendation, please refer to application note AN-1136: <http://www.irf.com/technical-info/appnotes/an-1136.pdf>
 For more information on package inspection techniques, please refer to application note AN-1154: <http://www.irf.com/technical-info/appnotes/an-1154.pdf>

PQFN 5x6 Part Marking

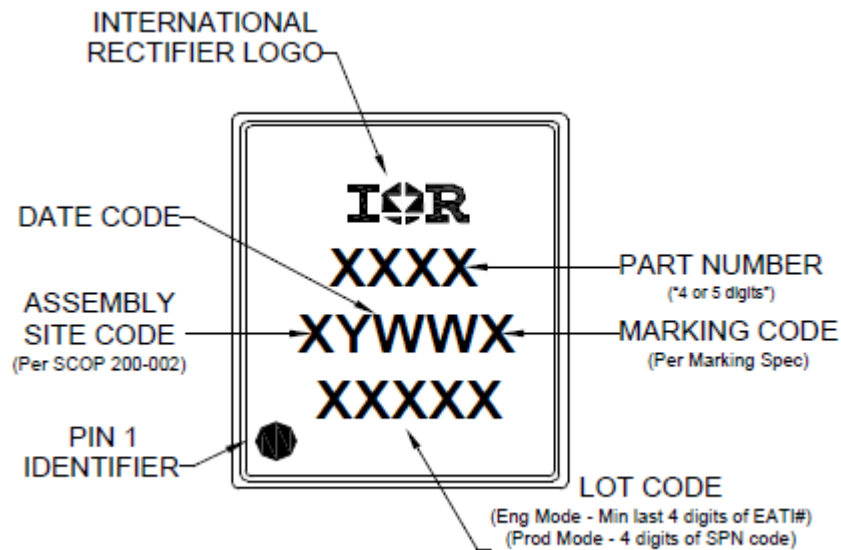

Note: For the most current drawing please refer to IR website at <http://www.irf.com/packaging>

PQFN 5x6 Tape and Reel

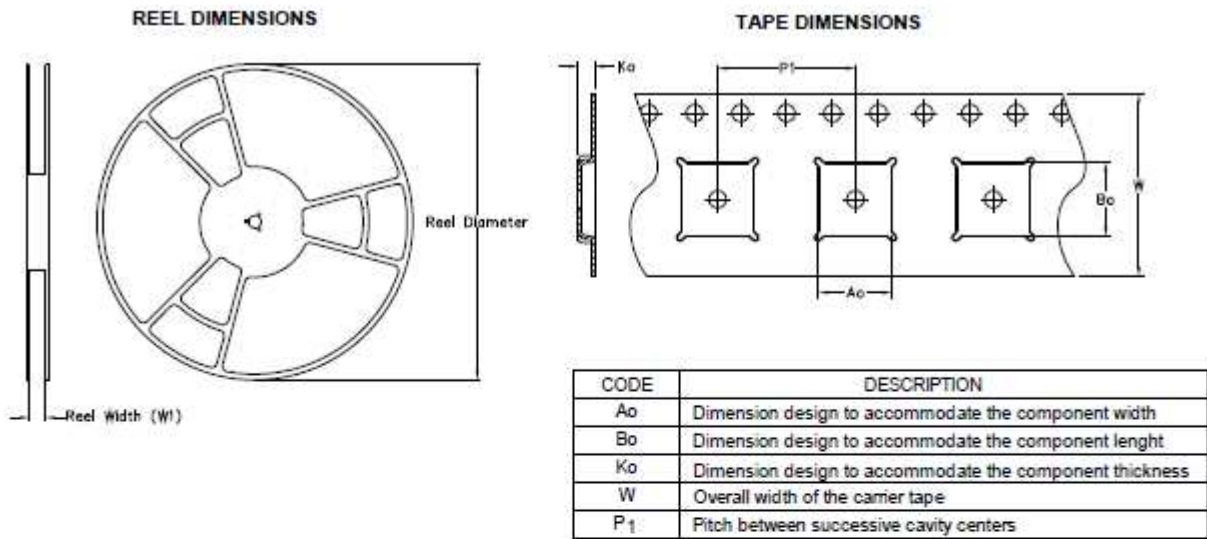

QUADRANT ASSIGNMENTS FOR PIN 1 ORIENTATION IN TAPE

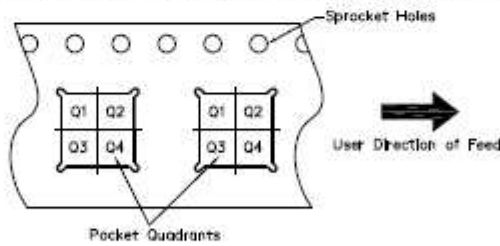

Note: All dimension are nominal

Package Type	Reel Diameter (Inch)	QTY	Reel Width W1 (mm)	Ao (mm)	Bo (mm)	Ko (mm)	P1 (mm)	W (mm)	Pin 1 Quadrant
5 X 6 PQFN	13	4000	12.4	6.300	5.300	1.20	8.00	12	Q1

Note: For the most current drawing please refer to IR website at <http://www.irf.com/packaging>

Qualification Information[†]

Qualification Level	Industrial (per JEDEC JESD47F [†] guidelines)	
Moisture Sensitivity Level	PQFN 5mm x 6mm	MSL1 (per JEDEC J-STD-020D [†])
RoHS Compliant	Yes	

† Applicable version of JEDEC standard at the time of product release.

Notes:

- ① Starting $T_J = 25^\circ\text{C}$, $L = 0.35\text{mH}$, $R_G = 50\Omega$, $I_{AS} = 50\text{A}$.
- ② Pulse width $\leq 400\mu\text{s}$; duty cycle $\leq 2\%$.
- ③ R_θ is measured at T_J of approximately 90°C .
- ④ When mounted on 1 inch square PCB (FR-4). Please refer to AN-994 for more details:
<http://www.irf.com/technical-info/appnotes/an-994.pdf>
- ⑤ Rating refers to the product only with datasheet specified absolute maximum values, maintaining case temperature at 25°C . For higher case temperature please refer to Diagram 9. De-rating will be required based on the actual environmental conditions.

Revision History

Date	Rev.	Comments
10/23/2013	2.1	<ul style="list-style-type: none"> • Added R_{dson} @ 4.5V-page1, 2
7/30/2014	2.2	<ul style="list-style-type: none"> • Updated IDM from "400A" to "700A" on page1, 2. • Updated Fig1, Fig2, Fig3, Fig7 & Fig8 on page 3, 4.
3/11/2015	2.3	<ul style="list-style-type: none"> • Updated package outline and tape and reel on pages 7 and 8.
12/14/2020	2.4	<ul style="list-style-type: none"> • Updated datasheet based on IFX template. • Updated Datasheet based on new current rating and application note : App-AN_1912_PL51_2001_180356 • Removed "HEXFET[®] Power MOSFET" -page1

Trademarks of Infineon Technologies AG

μ HVIC™, μ IPM™, μ PFC™, AU-ConvertIR™, AURIX™, C166™, CanPAK™, CIPOS™, CIPURSE™, CoolDP™, CoolGaN™, COOLiR™, CoolMOST™, CoolSET™, CoolSiC™, DAVE™, DI-POL™, DirectFET™, DrBlade™, EasyPIM™, EconoBRIDGE™, EconoDUAL™, EconoPACK™, EconoPIM™, EiceDRIVER™, eupec™, FCOS™, GaNpowIR™, HEXFET™, HITFET™, HybridPACK™, iMOTION™, IRAM™, ISOFACE™, IsoPACK™, LEDriviR™, LITIX™, MIPAQ™, ModSTACK™, my-d™, NovalithIC™, OPTIGA™, OptiMOS™, ORIGAT™, PowIRaudio™, PowIRstage™, PrimePACK™, PrimeSTACK™, PROFET™, PRO-SiL™, RASiC™, REAL3™, SmartLEWIS™, SOLID FLASH™, SPOC™, StrongIRFET™, SupIRBuck™, TEMPFET™, TRENCHSTOP™, TriCore™, UHVIC™, XHP™, XMC™

Trademarks updated November 2015

Other Trademarks

All referenced product or service names and trademarks are the property of their respective owners.

Edition 2016-04-16

Published by
Infineon Technologies AG
81726 Munich, Germany

© 2016 Infineon Technologies AG.
All Rights Reserved.

Do you have a question about this document?
Email: erratum@infineon.com

Document reference
ifx1

IMPORTANT NOTICE

The information given in this document shall in no event be regarded as a guarantee of conditions or **characteristics ("Beschaffenheitsgarantie")**.

With respect to any examples, hints or any typical values stated herein and/or any information regarding the application of the product, Infineon Technologies hereby disclaims any and all warranties and liabilities of any kind, including without limitation warranties of non-infringement of intellectual property rights of any third party.

In addition, any information given in this document **is subject to customer's compliance with its obligations** stated in this document and any applicable legal requirements, norms and standards concerning customer's products and any use of the product of Infineon Technologies in **customer's applications**.

The data contained in this document is exclusively intended for technically trained staff. It is the **responsibility of customer's technical departments** to evaluate the suitability of the product for the intended application and the completeness of the product information given in this document with respect to such application.

For further information on the product, technology, delivery terms and conditions and prices please contact your nearest Infineon Technologies office (www.infineon.com).

Please note that this product is not qualified according to the AEC Q100 or AEC Q101 documents of the Automotive Electronics Council.

WARNINGS

Due to technical requirements products may contain dangerous substances. For information on the types in question please contact your nearest Infineon Technologies office.

Except as otherwise explicitly approved by Infineon Technologies in a written document signed by authorized representatives of Infineon Technologies, **Infineon Technologies' products may not be used** in any applications where a failure of the product or any consequences of the use thereof can reasonably be expected to result in personal injury.

Looking for pricing, stock, or lifecycle information?

Click below to explore more details on WIN SOURCE:

 [View IRFH8201TRPBF on WIN SOURCE](#)

 [Infineon Technologies](#) Information

Optimize Your Supply Chain with WIN SOURCE Solutions

-  Global Sourcing Solution
-  Obsolete Management
-  Cost Control Management
-  Shortage Management
-  Alternative Solution
-  Excess Inventory Management