



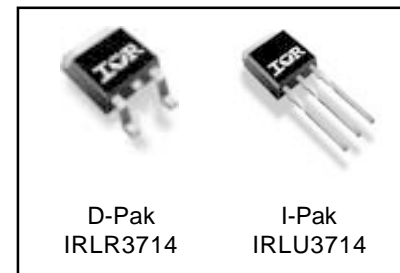
**Applications**

- High Frequency Isolated DC-DC Converters with Synchronous Rectification for Telecom and Industrial Use
- High Frequency Buck Converters for Computer Processor Power

<b>V<sub>DSS</sub></b>	<b>R<sub>DS(on)</sub> max</b>	<b>I<sub>D</sub></b>
<b>20V</b>	<b>20mΩ</b>	<b>36A</b>

**Benefits**

- Ultra-Low Gate Impedance
- Very Low R<sub>DS(on)</sub> at 4.5V V<sub>GS</sub>
- Fully Characterized Avalanche Voltage and Current



**Absolute Maximum Ratings**

Symbol	Parameter	Max.	Units
V <sub>DS</sub>	Drain-Source Voltage	20	V
V <sub>GS</sub>	Gate-to-Source Voltage	± 20	V
I <sub>D</sub> @ T <sub>C</sub> = 25°C	Continuous Drain Current, V <sub>GS</sub> @ 10V	36 ⑤	A
I <sub>D</sub> @ T <sub>C</sub> = 70°C	Continuous Drain Current, V <sub>GS</sub> @ 10V	31	
I <sub>DM</sub>	Pulsed Drain Current①	140	
P <sub>D</sub> @ T <sub>C</sub> = 25°C	Maximum Power Dissipation③	47	W
P <sub>D</sub> @ T <sub>C</sub> = 70°C	Maximum Power Dissipation③	33	W
	Linear Derating Factor	0.31	W/°C
T <sub>J</sub> , T <sub>STG</sub>	Junction and Storage Temperature Range	-55 to + 175	°C

**Thermal Resistance**

	Parameter	Typ.	Max.	Units
R <sub>θJC</sub>	Junction-to-Case	—	3.2	°C/W
R <sub>θJA</sub>	Junction-to-Ambient	—	50	
R <sub>θJA</sub>	Junction-to-Ambient (PCB mount)④	—	110	

Notes ① through ⑤ are on page 10

# IRLR3714/IRLU3714

International  
**IR** Rectifier

## Static @ $T_J = 25^\circ\text{C}$ (unless otherwise specified)

	Parameter	Min.	Typ.	Max.	Units	Conditions
$V_{(BR)DSS}$	Drain-to-Source Breakdown Voltage	20	—	—	V	$V_{GS} = 0V, I_D = 250\mu A$
$\Delta V_{(BR)DSS}/\Delta T_J$	Breakdown Voltage Temp. Coefficient	—	0.022	—	V/ $^\circ\text{C}$	Reference to $25^\circ\text{C}, I_D = 1mA$
$R_{DS(on)}$	Static Drain-to-Source On-Resistance	—	15	20	m $\Omega$	$V_{GS} = 10V, I_D = 18A$ ③
		—	21	28		$V_{GS} = 4.5V, I_D = 14A$ ③
$V_{GS(th)}$	Gate Threshold Voltage	1.0	—	3.0	V	$V_{DS} = V_{GS}, I_D = 250\mu A$
$I_{DSS}$	Drain-to-Source Leakage Current	—	—	20	$\mu A$	$V_{DS} = 16V, V_{GS} = 0V$
		—	—	100		$V_{DS} = 16V, V_{GS} = 0V, T_J = 125^\circ\text{C}$
$I_{GSS}$	Gate-to-Source Forward Leakage	—	—	200	nA	$V_{GS} = 16V$
	Gate-to-Source Reverse Leakage	—	—	-200		$V_{GS} = -16V$

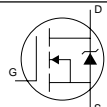
## Dynamic @ $T_J = 25^\circ\text{C}$ (unless otherwise specified)

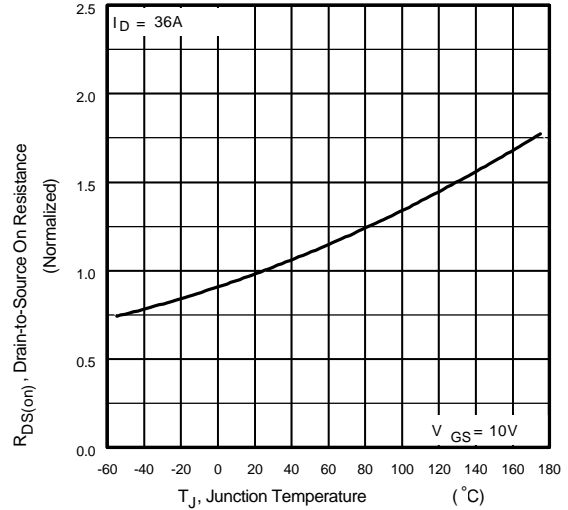
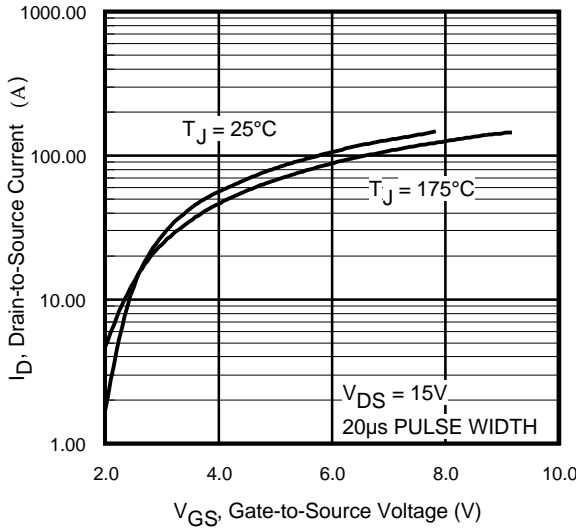
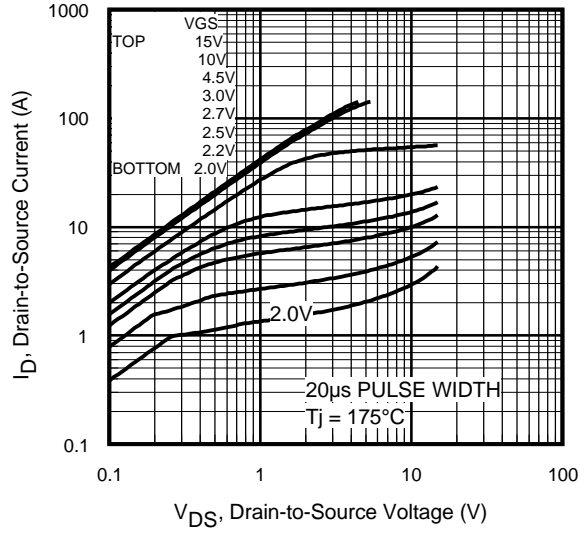
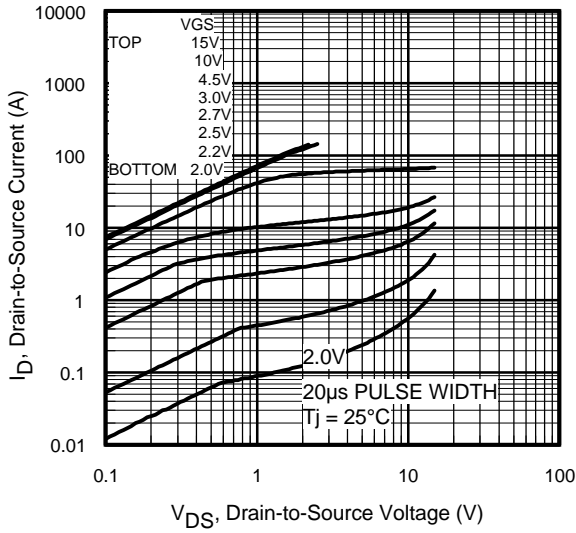
Symbol	Parameter	Min.	Typ.	Max.	Units	Conditions
$g_{fs}$	Forward Transconductance	17	—	—	S	$V_{DS} = 10V, I_D = 14A$
$Q_g$	Total Gate Charge	—	6.5	9.7	nC	$I_D = 14A$
$Q_{gs}$	Gate-to-Source Charge	—	1.8	—		$V_{DS} = 10V$
$Q_{gd}$	Gate-to-Drain ("Miller") Charge	—	2.9	—		$V_{GS} = 4.5V$
$Q_{oss}$	Output Gate Charge	—	7.1	—		$V_{GS} = 0V, V_{DS} = 10V$
$t_{d(on)}$	Turn-On Delay Time	—	8.7	—	ns	$V_{DD} = 10V$
$t_r$	Rise Time	—	78	—		$I_D = 14A$
$t_{d(off)}$	Turn-Off Delay Time	—	10	—		$R_G = 1.8\Omega$
$t_f$	Fall Time	—	4.5	—		$V_{GS} = 4.5V$ ③
$C_{iss}$	Input Capacitance	—	670	—	pF	$V_{GS} = 0V$
$C_{oss}$	Output Capacitance	—	470	—		$V_{DS} = 10V$
$C_{rss}$	Reverse Transfer Capacitance	—	68	—		$f = 1.0MHz$

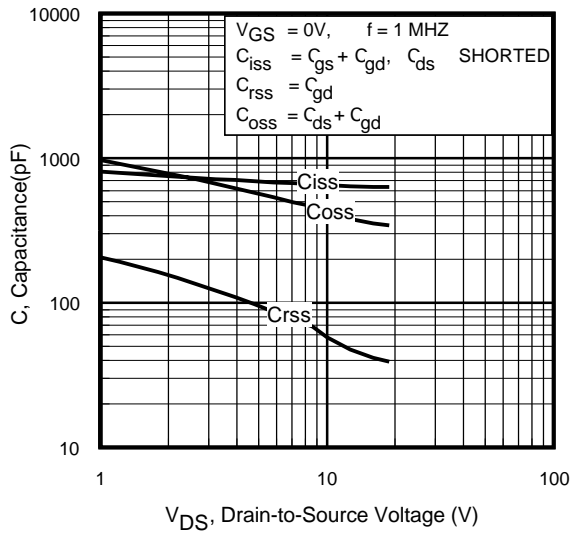
## Avalanche Characteristics

Symbol	Parameter	Typ.	Max.	Units
$E_{AS}$	Single Pulse Avalanche Energy②	—	72	mJ
$I_{AR}$	Avalanche Current①	—	14	A

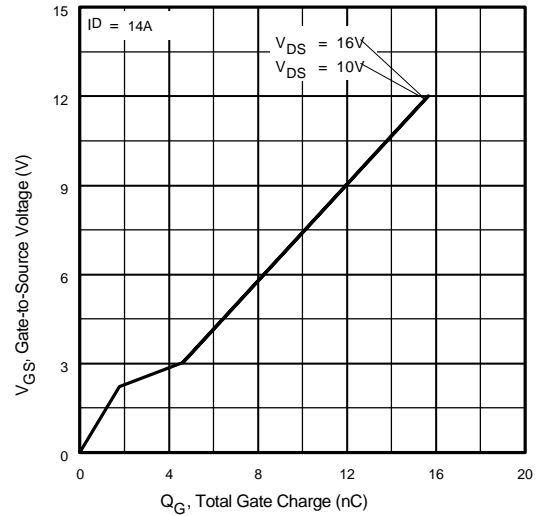
## Diode Characteristics

Symbol	Parameter	Min.	Typ.	Max.	Units	Conditions
$I_S$	Continuous Source Current (Body Diode)	—	36⑤	—	A	MOSFET symbol showing the integral reverse p-n junction diode. 
$I_{SM}$	Pulsed Source Current (Body Diode) ①	—	140	—		
$V_{SD}$	Diode Forward Voltage	—	—	1.3	V	$T_J = 25^\circ\text{C}, I_S = 18A, V_{GS} = 0V$ ③
		—	0.88	—		$T_J = 125^\circ\text{C}, I_S = 18A, V_{GS} = 0V$ ③
$t_{rr}$	Reverse Recovery Time	—	35	53	ns	$T_J = 25^\circ\text{C}, I_F = 18A, V_R = 10V$
$Q_{rr}$	Reverse Recovery Charge	—	34	51	nC	$di/dt = 100A/\mu s$ ③
$t_{rr}$	Reverse Recovery Time	—	35	53	ns	$T_J = 125^\circ\text{C}, I_F = 18A, V_R = 10V$
$Q_{rr}$	Reverse Recovery Charge	—	35	53	nC	$di/dt = 100A/\mu s$ ③

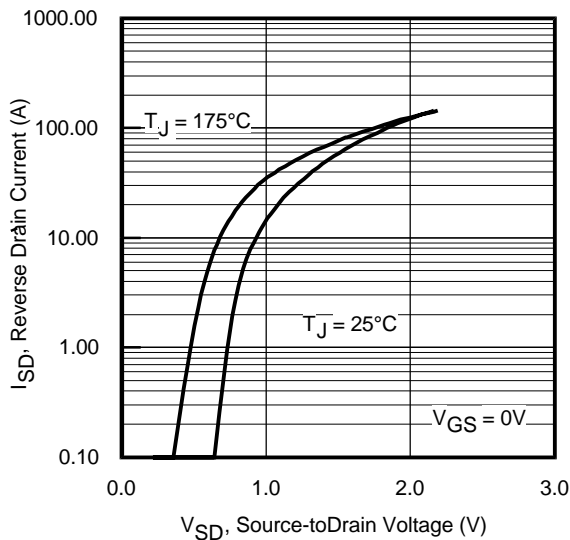




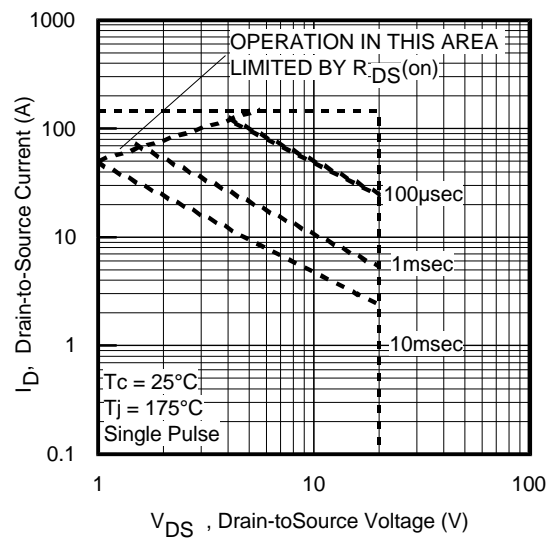
**Fig 5.** Typical Capacitance Vs. Drain-to-Source Voltage



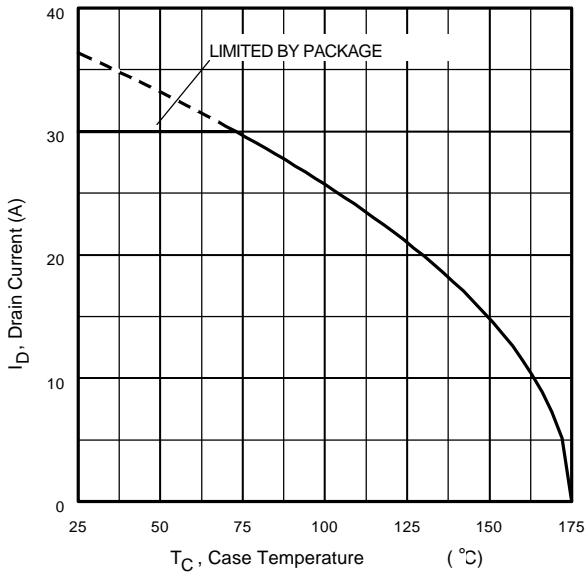
**Fig 6.** Typical Gate Charge Vs. Gate-to-Source Voltage



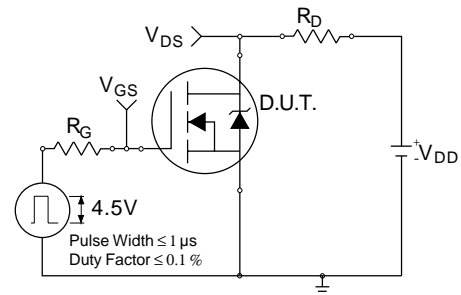
**Fig 7.** Typical Source-Drain Diode Forward Voltage



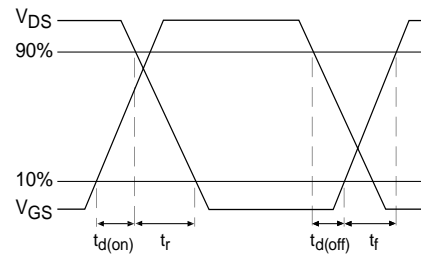
**Fig 8.** Maximum Safe Operating Area



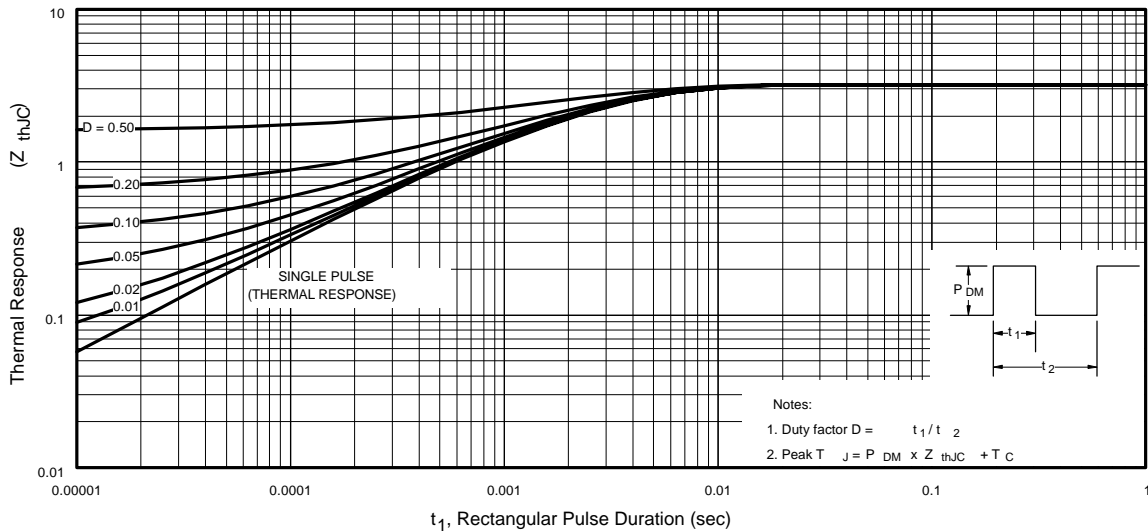
**Fig 9.** Maximum Drain Current Vs. Case Temperature



**Fig 10a.** Switching Time Test Circuit

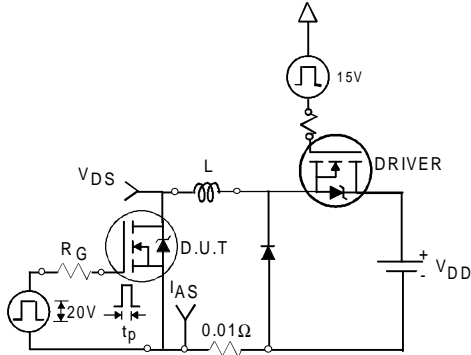


**Fig 10b.** Switching Time Waveforms

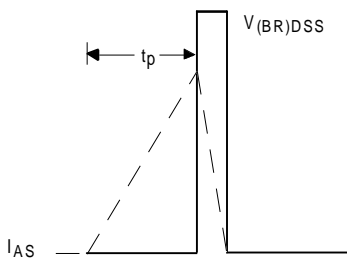


**Fig 11.** Maximum Effective Transient Thermal Impedance, Junction-to-Case

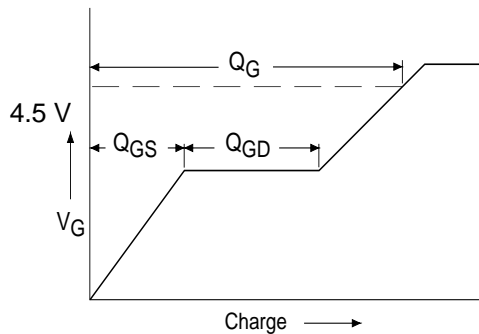
# IRLR3714/IRLU3714



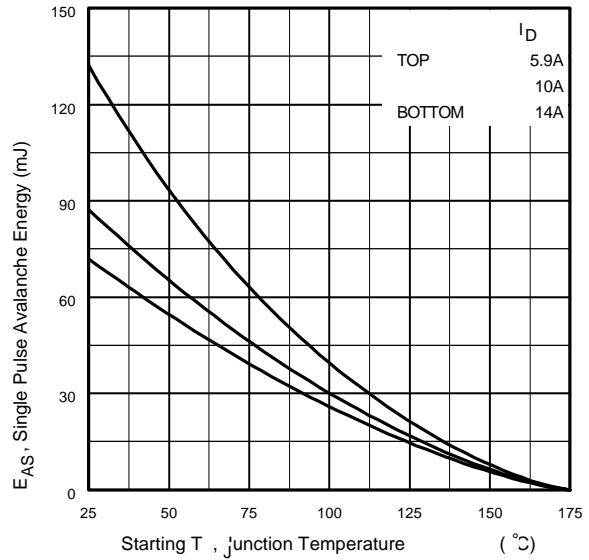
**Fig 12a.** Unclamped Inductive Test Circuit



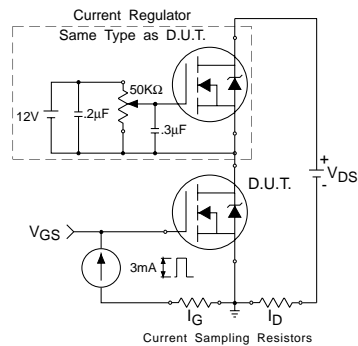
**Fig 12b.** Unclamped Inductive Waveforms



**Fig 13a.** Basic Gate Charge Waveform

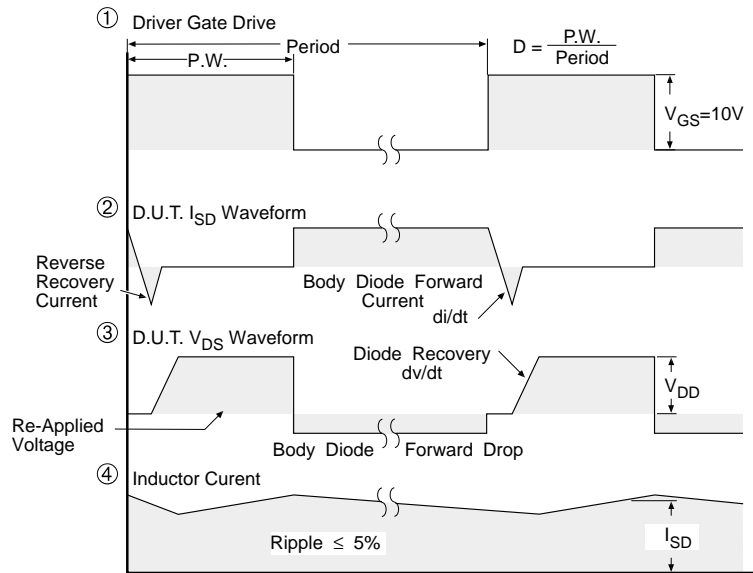
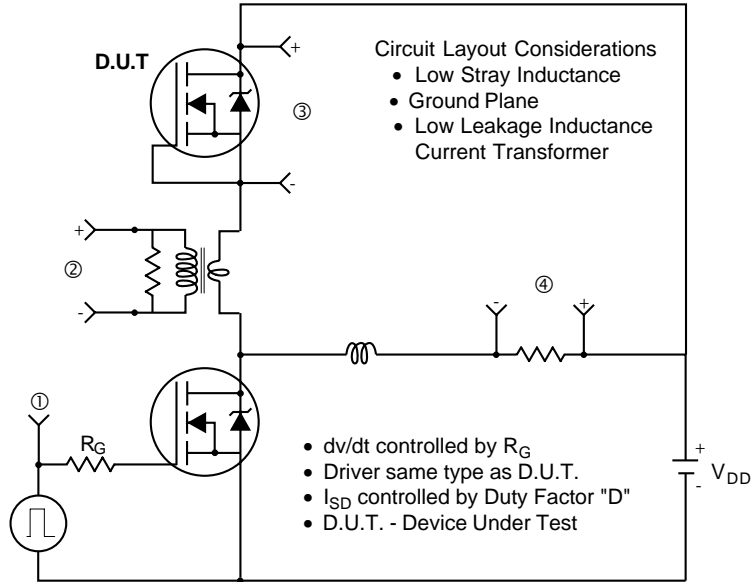


**Fig 12c.** Maximum Avalanche Energy Vs. Drain Current



**Fig 13b.** Gate Charge Test Circuit

**Peak Diode Recovery dv/dt Test Circuit**



\*  $V_{GS} = 5V$  for Logic Level Devices

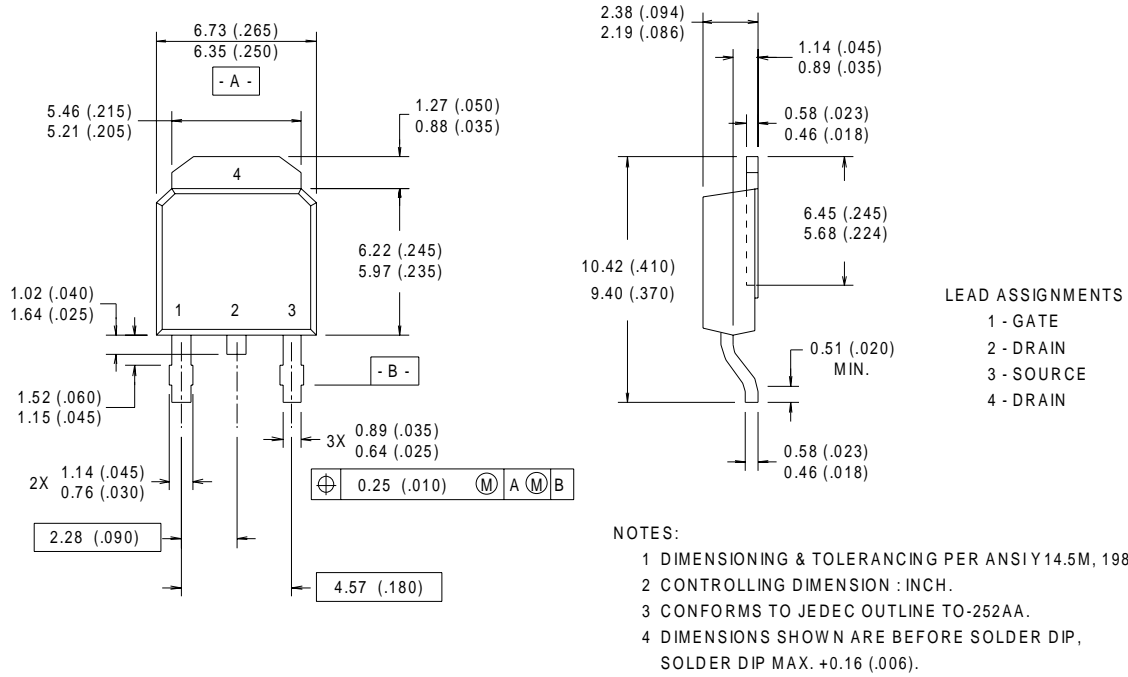
**Fig 14.** For N-Channel HEXFET® Power MOSFETs

# IRLR3714/IRLU3714

International  
**IR** Rectifier

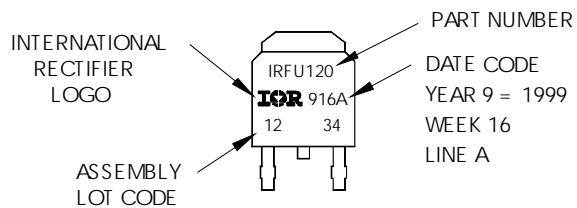
## D-Pak (TO-252AA) Package Outline

Dimensions are shown in millimeters (inches)



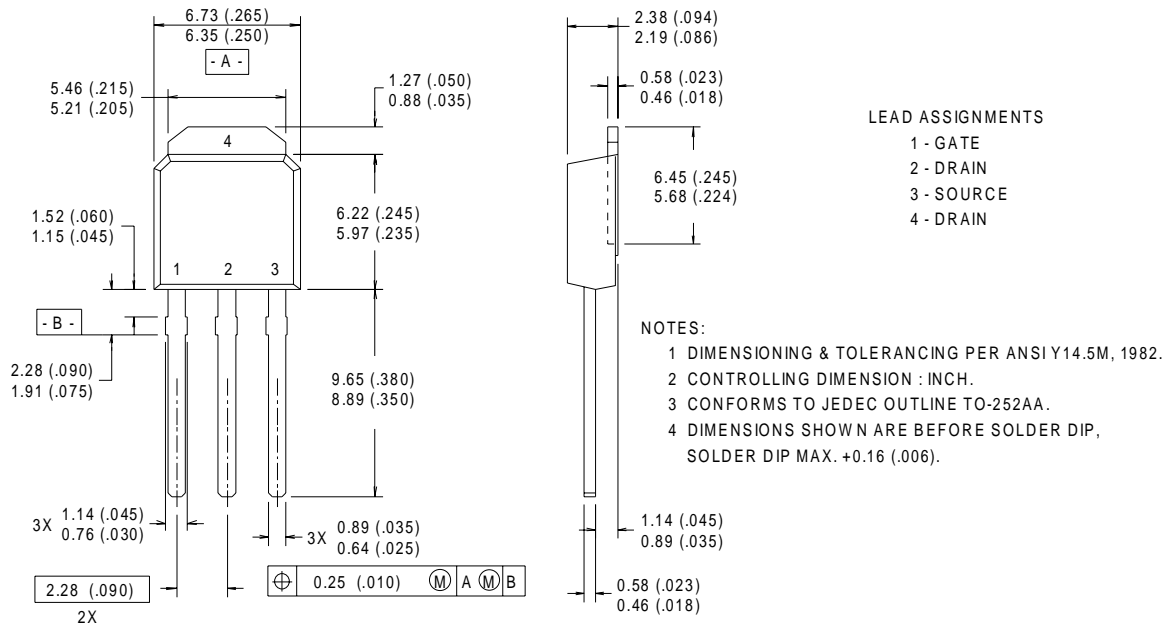
## D-Pak (TO-252AA) Part Marking Information

EXAMPLE: THIS IS AN IRFR120  
WITH ASSEMBLY  
LOT CODE 1234  
ASSEMBLED ON WW 16, 1999  
IN THE ASSEMBLY LINE "A"



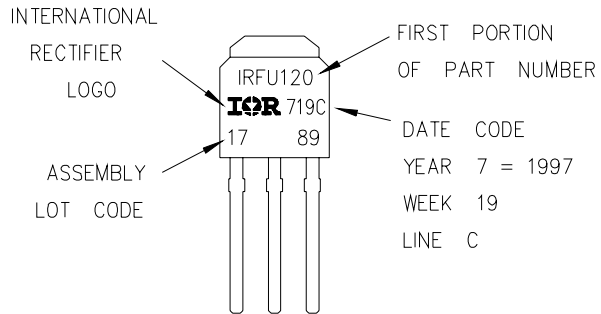
## I-Pak (TO-251AA) Package Outline

Dimensions are shown in millimeters (inches)



## I-Pak (TO-251AA) Part Marking Information

EXAMPLE: THIS IS AN IRFU120  
 LOT CODE 1789  
 ASSEMBLED ON WW 19, 1997  
 IN THE ASSEMBLY LINE "C"

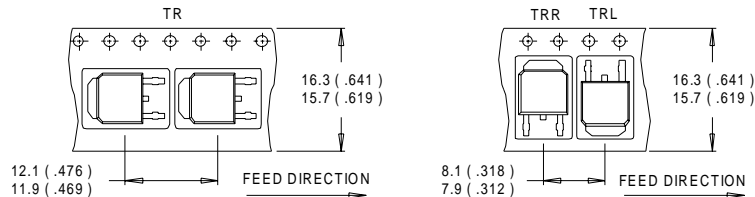


# IRLR3714/IRLU3714

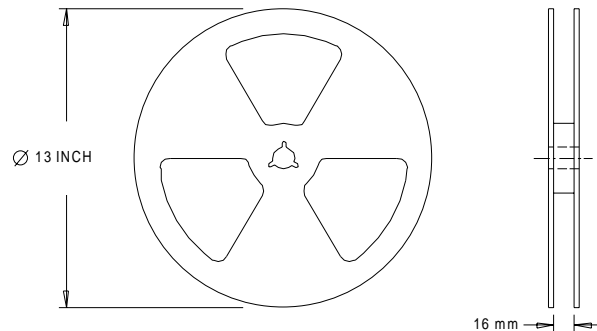
International  
**IR** Rectifier

## D-Pak (TO-252AA) Tape & Reel Information

Dimensions are shown in millimeters (inches)



- NOTES :
1. CONTROLLING DIMENSION : MILLIMETER.
  2. ALL DIMENSIONS ARE SHOWN IN MILLIMETERS ( INCHES ).
  3. OUTLINE CONFORMS TO EIA-481 & EIA-541.



- NOTES :
1. OUTLINE CONFORMS TO EIA-481.

### Notes:

- ① Repetitive rating; pulse width limited by max. junction temperature.
- ② Starting  $T_J = 25^\circ\text{C}$ ,  $L = 0.69 \text{ mH}$   
 $R_G = 25\Omega$ ,  $I_{AS} = 14\text{A}$ .
- ③ Pulse width  $\leq 400\mu\text{s}$ ; duty cycle  $\leq 2\%$ .
- ④ When mounted on 1" square PCB ( FR-4 or G-10 Material ). For recommended footprint and soldering techniques refer to application note #AN-994.
- ⑤ Calculated continuous current based on maximum allowable junction temperature; Package limitation current is 30A

Data and specifications subject to change without notice.  
These products have been designed and qualified for the Industrial market.  
Qualification Standards can be found on IR's Web site.

International  
**IR** Rectifier

IR WORLD HEADQUARTERS: 233 Kansas St., El Segundo, California 90245, USA Tel: (310) 252-7105  
TAC Fax: (310) 252-7903

Visit us at [www.irf.com](http://www.irf.com) for sales contact information.06/01

[www.irf.com](http://www.irf.com)

Note: For the most current drawings please refer to the IR website at:  
<http://www.irf.com/package/>

## Looking for pricing, stock, or lifecycle information?

Click below to explore more details on WIN SOURCE:

 [View IRLR3714TRR on WIN SOURCE](#)

 [Infineon Technologies](#) Information

## Optimize Your Supply Chain with WIN SOURCE Solutions

-  Global Sourcing Solution
-  Obsolete Management
-  Cost Control Management
-  Shortage Management
-  Alternative Solution
-  Excess Inventory Management