



**THE DATASHEET OF  
IRLR8103VTRRPBF**



# IRLR8103VPbF

- N-Channel Application-Specific MOSFETs
- Ideal for CPU Core DC-DC Converters
- Low Conduction Losses
- Low Switching Losses
- Minimizes Parallel MOSFETs for high current applications
- 100%  $R_G$  Tested
- Lead-Free

### Description

This new device employs advanced HEXFET Power MOSFET technology to achieve an unprecedented balance of on-resistance and gate charge. The reduced conduction and switching losses make it ideal for high efficiency DC-DC converters that power the latest generation of microprocessors.

The IRLR8103V has been optimized for all parameters that are critical in synchronous buck converters including  $R_{DS(on)}$ , gate charge and  $C_{dv}/dt$ -induced turn-on immunity. The IRLR8103V offers an extremely low combination of  $Q_{sw}$  &  $R_{DS(on)}$  for reduced losses in both control and synchronous FET applications.

The package is designed for vapor phase, infra-red, convection, or wave soldering techniques. Power dissipation of greater than 2W is possible in a typical PCB mount application.

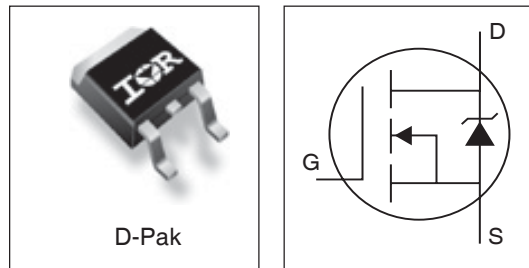

### DEVICE CHARACTERISTICS<sup>⑤</sup>

	<b>IRLR8103V</b>
$R_{DS(on)}$	7.9 m $\Omega$
$Q_G$	27 nC
$Q_{SW}$	12 nC
$Q_{OSS}$	29nC

### Absolute Maximum Ratings

Parameter		Symbol	IRLR8103V	Units
Drain-Source Voltage		$V_{DS}$	30	V
Gate-Source Voltage		$V_{GS}$	$\pm 20$	
Continuous Drain or Source Current ( $V_{GS} > 10V$ )	TC = 25°C	$I_D$	91	A
	TC = 90°C		63	
Pulsed Drain Current <sup>①</sup>		$I_{DM}$	363	
Power Dissipation <sup>③</sup>	TC = 25°C	$P_D$	115	W
	TC = 90°C		60	
Junction & Storage Temperature Range		$T_J, T_{STG}$	-55 to 150	°C
Continuous Source Current (Body Diode)		$I_S$	91	A
Pulsed Source Current <sup>①</sup>		$I_{SM}$	363	

### Thermal Resistance

Parameter	Symbol	Typ.	Max.	Units
Maximum Junction-to-Ambient <sup>③⑥</sup>	$R_{\theta JA}$	—	50	°C/W
Maximum Junction-to-Case <sup>⑥</sup>	$R_{\theta JC}$	—	1.09	

## Electrical Characteristics

Parameter	Symbol	Min	Typ	Max	Units	Conditions
Drain-to-Source Breakdown Voltage	$V_{DSS}$	30	—	—	V	$V_{GS} = 0V, I_D = 250\mu A$
Static Drain-Source On-Resistance	$R_{DS(on)}$	—	6.9	9.0	m $\Omega$	$V_{GS} = 10V, I_D = 15A$ ②
		—	7.9	10.5		$V_{GS} = 4.5V, I_D = 15A$ ②
Gate Threshold Voltage	$V_{GS(th)}$	1.0	—	3.0	V	$V_{DS} = V_{GS}, I_D = 250\mu A$
Drain-to-Source Leakage Current	$I_{DSS}$	—	—	50	$\mu A$	$V_{DS} = 30V, V_{GS} = 0V$
		—	—	20	$\mu A$	$V_{DS} = 24V, V_{GS} = 0$
		—	—	100		$V_{DS} = 24V, V_{GS} = 0, T_J = 100^\circ C$
Gate-Source Leakage Current	$I_{GSS}$	—	—	$\pm 100$	nA	$V_{GS} = \pm 20V$
Total Gate Charge, Control FET	$Q_G$	—	27	—	nC	$V_{GS} = 5V, I_D = 15A, V_{DS} = 16V$
Total Gate Charge, Synch FET	$Q_G$	—	23	—		$V_{GS} = 5V, V_{DS} < 100mV$
Pre-Vth Gate-Source Charge	$Q_{GS1}$	—	4.7	—		$V_{DS} = 16V, I_D = 15A$
Post-Vth Gate-Source Charge	$Q_{GS2}$	—	2.0	—		
Gate to Drain Charge	$Q_{GD}$	—	9.7	—		
Switch Charge ( $Q_{GS2} + Q_{GD}$ )	$Q_{SW}$	—	12	—		
Output Charge	$Q_{OSS}$	—	29	—		
Gate Resistance	$R_G$	0.8	—	3.1		$\Omega$
Turn-On Delay Time	$t_{d(on)}$	—	10	—	ns	$V_{DD} = 16V$
Rise Time	$t_r$	—	9	—		$I_D = 15A$
Turn-Off Delay Time	$t_{d(off)}$	—	24	—		$V_{GS} = 5.0V$
Fall Time	$t_f$	—	18	—		Clamped Inductive Load
Input Capacitance	$C_{iss}$	—	2672	—	pF	$V_{GS} = 16V, V_{GS}=0$
Output Capacitance	$C_{oss}$	—	1064	—		
Reverse Transfer Capacitance	$C_{rss}$	—	109	—		

## Source-Drain Rating & Characteristics

Parameter	Symbol	Min	Typ	Max	Units	Conditions
Diode Forward Voltage	$V_{SD}$	—	0.9	1.3	V	$I_S = 15A$ ②, $V_{GS} = 0V$
Reverse Recovery Charge ④	$Q_{rr}$	—	103	—	nC	$di/dt \sim 700A/\mu s$ $V_{DS} = 16V, V_{GS} = 0V, I_F = 15A$
Reverse Recovery Charge (with Parallel Schottky) ④	$Q_{rr(s)}$	—	96	—	nC	$di/dt = 700A/\mu s$ , (with 10BQ040) $V_{DS} = 16V, V_{GS} = 0V, I_F = 15A$

### Notes:

- ① Repetitive rating; pulse width limited by max. junction temperature.
- ② Pulse width  $\leq 400 \mu s$ ; duty cycle  $\leq 2\%$ .
- ③ When mounted on 1 inch square copper board,  $t < 10$  sec.
- ④ Typ = measured -  $Q_{oss}$
- ⑤ Typical values of  $R_{DS(on)}$  measured at  $V_{GS} = 4.5V$ ,  $Q_G$ ,  $Q_{SW}$  and  $Q_{OSS}$  measured at  $V_{GS} = 5.0V$ ,  $I_F = 15A$ .

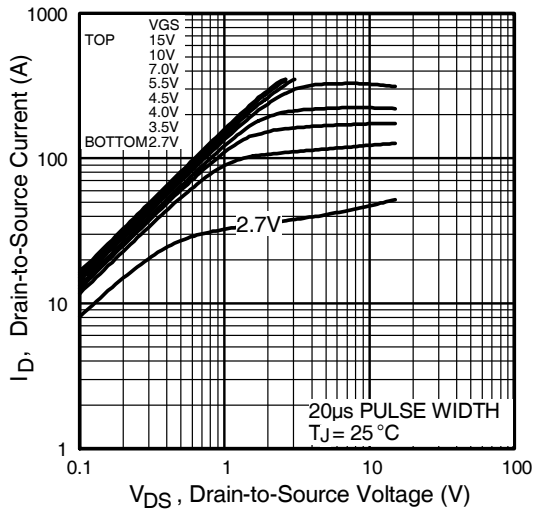

**Fig 1.** Typical Output Characteristics

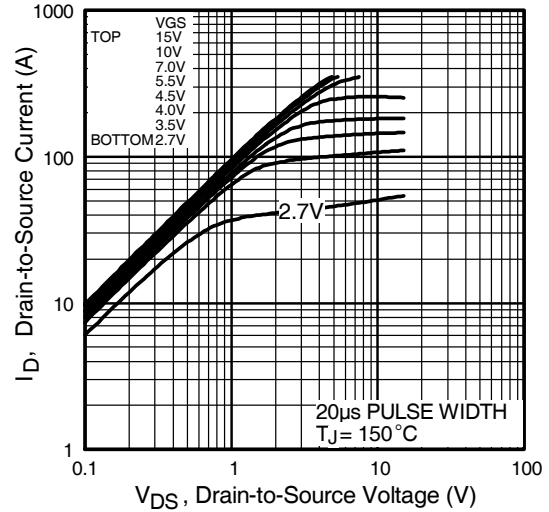

**Fig 2.** Typical Output Characteristics

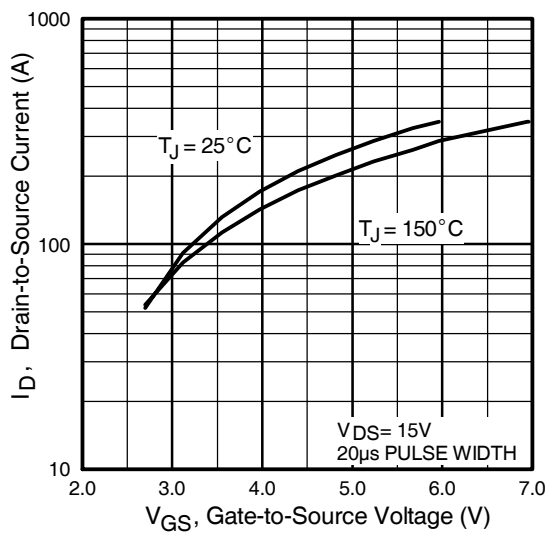

**Fig 3.** Typical Transfer Characteristics

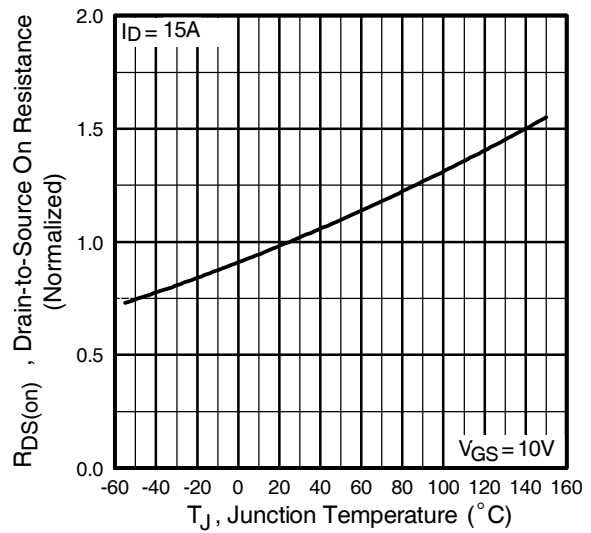

**Fig 4.** Normalized On-Resistance Vs. Temperature

# IRLR8103VPbF

International  
**IR** Rectifier

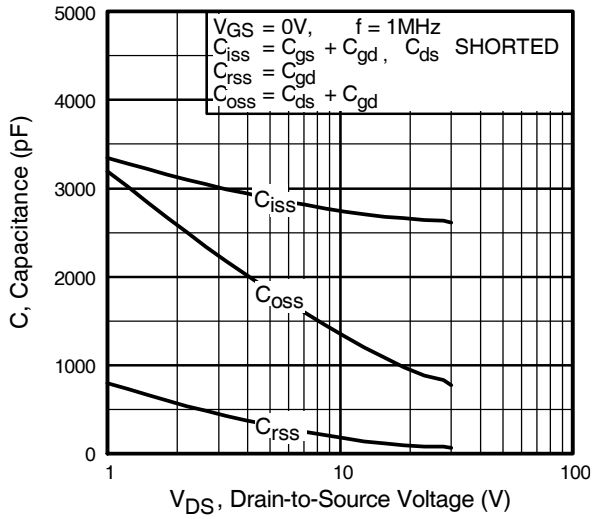

**Fig 5.** Typical Capacitance Vs. Drain-to-Source Voltage

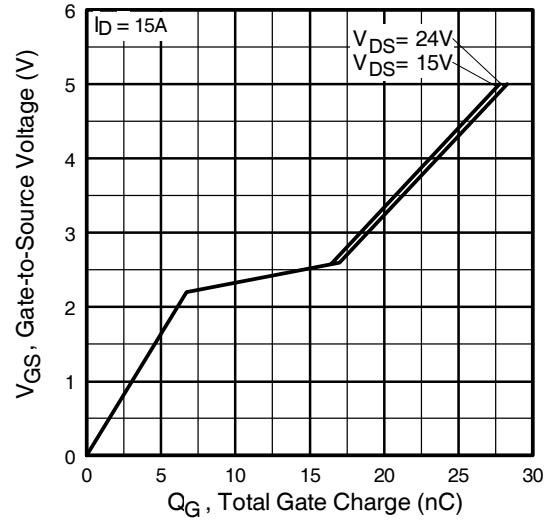

**Fig 6.** Typical Gate Charge Vs. Gate-to-Source Voltage

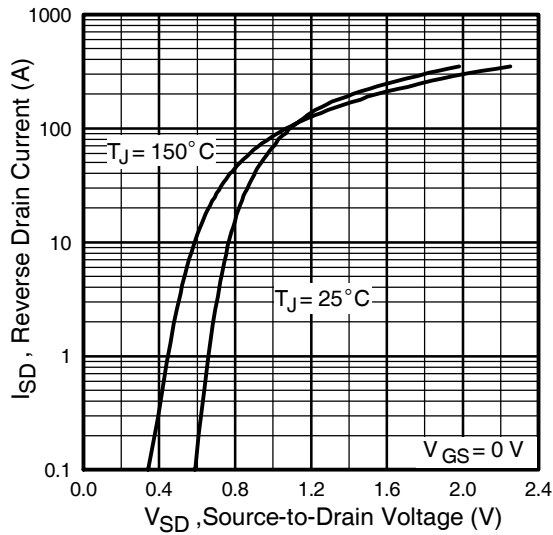

**Fig 7.** Typical Source-Drain Diode Forward Voltage

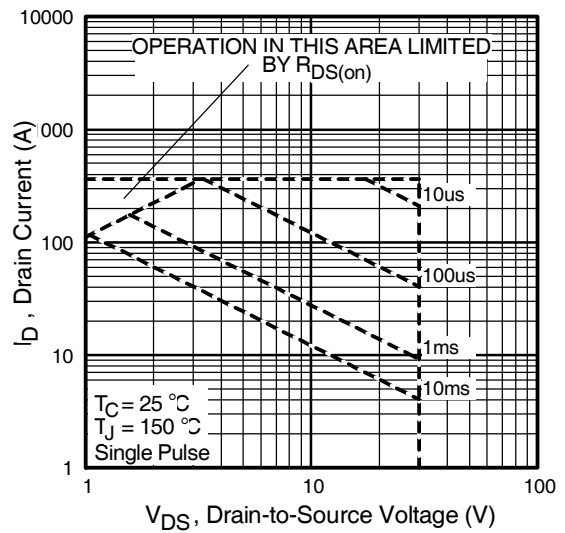

**Fig 8.** Maximum Safe Operating Area

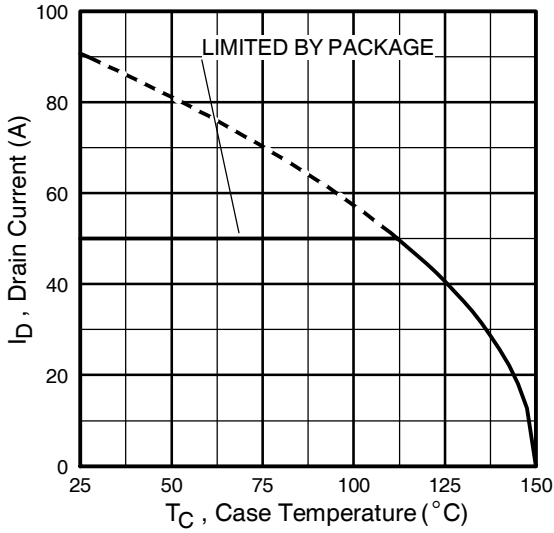

**Fig 9. Maximum Drain Current Vs. Case Temperature**

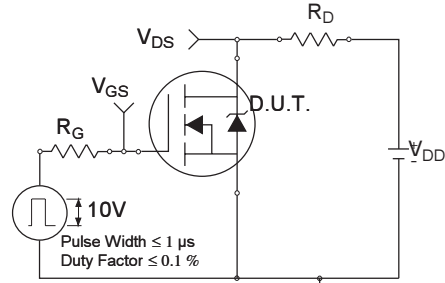

**Fig 10a. Switching Time Test Circuit**

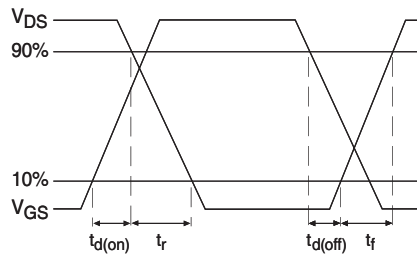

**Fig 10b. Switching Time Waveforms**

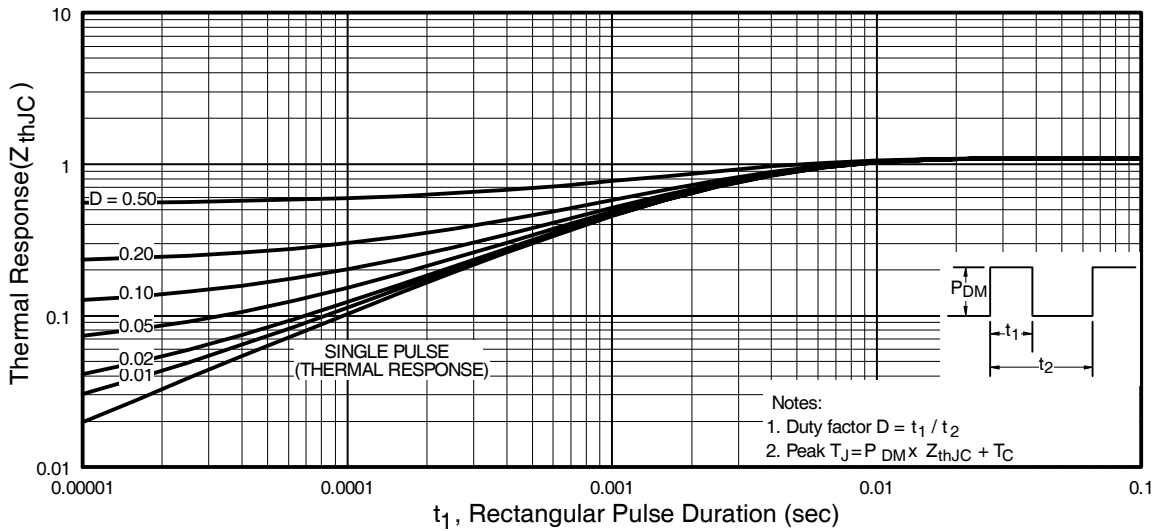

**Fig 11. Maximum Effective Transient Thermal Impedance, Junction-to-Case**

# IRLR8103VPbF

International  
**IR** Rectifier

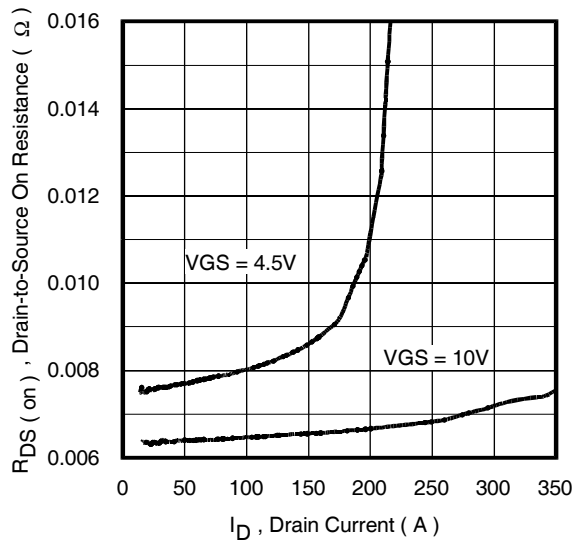

**Fig 12.** On-Resistance Vs. Drain Current

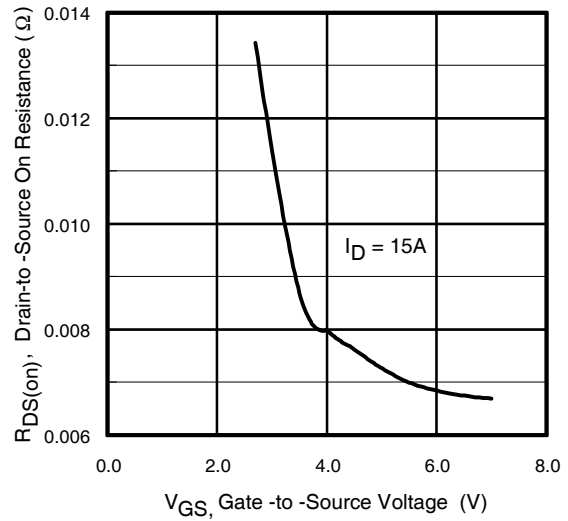

**Fig 13.** On-Resistance Vs. Gate Voltage

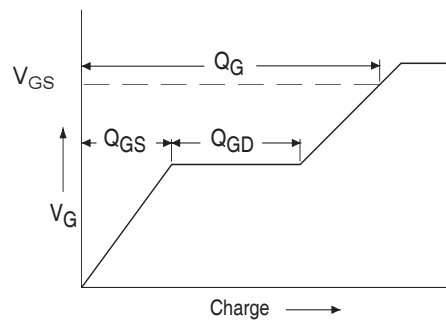
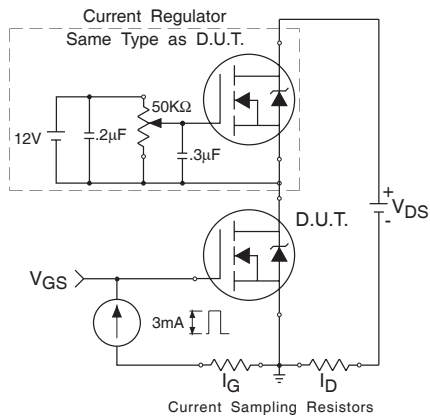

**Fig 14a&b.** Basic Gate Charge Test Circuit and Waveform

## D-Pak (TO-252AA) Package Outline

Dimensions are shown in millimeters (inches)

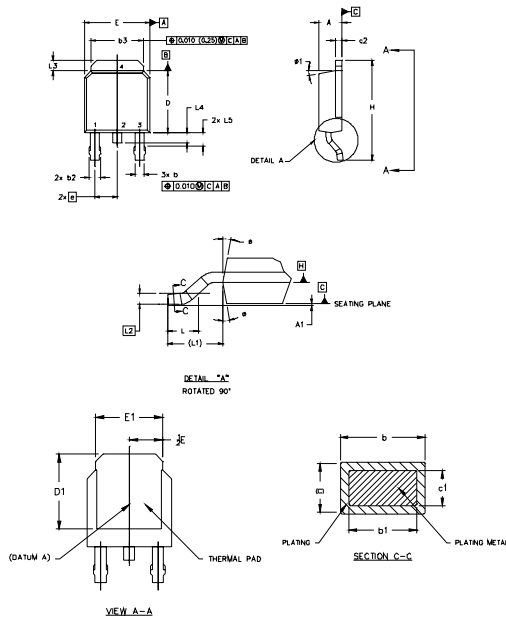

NOTES:

- 1.0 DIMENSIONING AND TOLERANCING PER ASME Y14.5 M- 1994.
- 2.0 DIMENSIONS ARE SHOWN IN INCHES [MILLIMETERS].
- 3.0 LEAD DIMENSION UNCONTROLLED IN L5.
- 4.0 DIMENSION D1 AND E1 ESTABLISH A MINIMUM MOUNTING SURFACE FOR THERMAL PAD.
- 5.0 SECTION C-C DIMENSIONS APPLY TO THE FLAT SECTION OF THE LEAD BETWEEN .005 (0.127) AND .010 (0.254) FROM THE LEAD TIP.
- 6.0 DIMENSION D & E DO NOT INCLUDE MOLD FLASH. MOLD FLASH SHALL NOT EXCEED .005" (0.127) PER SIDE. THESE DIMENSIONS ARE MEASURED AT THE OUTERMOST EXTREMES OF THE PLASTIC BODY.
- 7.0 OUTLINE CONFORMS TO JEDEC OUTLINE TO-252AA.

SYMBOL	DIMENSIONS				NOTES
	MILLIMETERS		INCHES		
	MIN.	MAX.	MIN.	MAX.	
A	2.18	2.39	.086	.094	
A1		0.13		.005	
b	0.84	0.98	.033	.039	5
b1	0.84	0.79	.033	.031	5
b2	0.76	1.14	.030	.045	
b3	4.93	5.46	.193	.215	
c	0.48	0.61	.018	.024	5
c1	0.41	0.56	.016	.022	5
c2	0.96	0.98	.038	.039	5
D	0.97	0.22	.239	.249	6
D1	0.21	-	.005	-	4
E	6.35	6.13	.250	.245	6
E1	4.32	-	.170	-	4
e	2.29		.090 BSC		
H	6.48	10.41	.250	.410	
L	1.40	1.76	.055	.070	
L1	2.74 REF.		.108 REF.		
L2	0.50 BSC		.020 BSC		
L3	0.88	1.27	.035	.050	
L4		1.02		.040	
L5	1.14	1.52	.045	.060	3
#	0°	10°	0°	10°	
#1	0°	10°	0°	10°	

LEAD ASSIGNMENTS

- 1- GATE
- 2- DRAIN
- 3- SOURCE
- 4- DRAIN

IRFES. GSPACK

- 1- GATE
- 2- COLLECTOR
- 3- EMITTER
- 4- COLLECTOR

## D-Pak (TO-252AA) Part Marking Information

EXAMPLE: THIS IS AN IRFR120  
WITH ASSEMBLY  
LOT CODE 1234  
ASSEMBLED ON WW 16, 1999  
IN THE ASSEMBLY LINE "A"

Note: "P" in assembly line position  
indicates "Lead-Free"

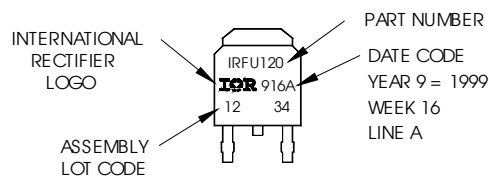

OR

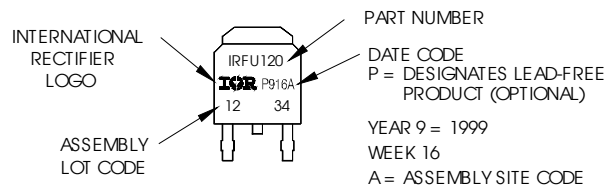

# IRLR8103VPbF

International  
**IR** Rectifier

## D-Pak (TO-252AA) Tape & Reel Information

Dimensions are shown in millimeters (inches)

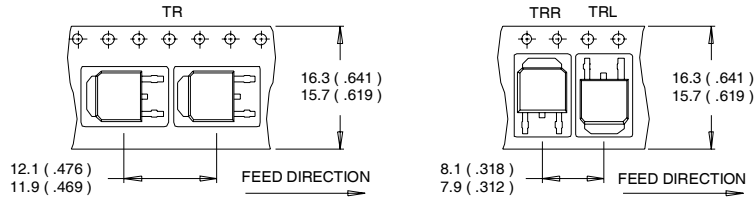

- NOTES :
1. CONTROLLING DIMENSION : MILLIMETER.
  2. ALL DIMENSIONS ARE SHOWN IN MILLIMETERS ( INCHES ).
  3. OUTLINE CONFORMS TO EIA-481 & EIA-541.

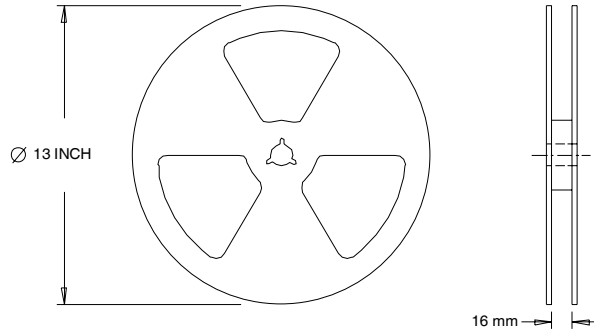

- NOTES :
1. OUTLINE CONFORMS TO EIA-481.

Data and specifications subject to change without notice.

International  
**IR** Rectifier

IR WORLD HEADQUARTERS: 233 Kansas St., El Segundo, California 90245, USA Tel: (310) 252-7105

TAC Fax: (310) 252-7903

Visit us at [www.irf.com](http://www.irf.com) for sales contact information.12/04

[www.irf.com](http://www.irf.com)

Note: For the most current drawings please refer to the IR website at:  
<http://www.irf.com/package/>

## **IMPORTANT NOTICE**

The information given in this document shall in no event be regarded as a guarantee of conditions or characteristics ("Beschaffenheitsgarantie").

With respect to any examples, hints or any typical values stated herein and/or any information regarding the application of the product, Infineon Technologies hereby disclaims any and all warranties and liabilities of any kind, including without limitation warranties of non-infringement of intellectual property rights of any third party.

In addition, any information given in this document is subject to customer's compliance with its obligations stated in this document and any applicable legal requirements, norms and standards concerning customer's products and any use of the product of Infineon Technologies in customer's applications.

The data contained in this document is exclusively intended for technically trained staff. It is the responsibility of customer's technical departments to evaluate the suitability of the product for the intended application and the completeness of the product information given in this document with respect to such application.

For further information on the product, technology, delivery terms and conditions and prices please contact your nearest Infineon Technologies office ([www.infineon.com](http://www.infineon.com)).

## **WARNINGS**

Due to technical requirements products may contain dangerous substances. For information on the types in question please contact your nearest Infineon Technologies office.

Except as otherwise explicitly approved by Infineon Technologies in a written document signed by authorized representatives of Infineon Technologies, Infineon Technologies' products may not be used in any applications where a failure of the product or any consequences of the use thereof can reasonably be expected to result in personal injury.

## Looking for pricing, stock, or lifecycle information?

Click below to explore more details on WIN SOURCE:

 [View IRLR8103VTRRPBF on WIN SOURCE](#)

 [Infineon Technologies](#) Information

## Optimize Your Supply Chain with WIN SOURCE Solutions

-  Global Sourcing Solution
-  Obsolete Management
-  Cost Control Management
-  Shortage Management
-  Alternative Solution
-  Excess Inventory Management