



THE DATASHEET OF ISQ2X



ISD2
ISQ2



ISOCOM

COMPONENTS

HIGH DENSITY PHOTOTRANSISTOR OPTICALLY COUPLED ISOLATORS



APPROVALS

- UL recognised, File No. E91231

DESCRIPTION

The IS*2 series of optically coupled isolators consist of infrared light emitting diodes and NPN silicon photo transistors in space efficient dual in line plastic packages.

FEATURES

- Options :-
10mm lead spread - add G after part no.
Surface mount - add SM after part no.
Tape&reel - add SMT&R after part no.
- Current Transfer Ratio (100% to 150%)
- High Isolation Voltage (5.3kV_{RMS}, 7.5kV_{PK})
- High BV_{CEO} (70V min)

APPLICATIONS

- Computer terminals
- Industrial systems controllers
- Measuring instruments
- Signal transmission between systems of different potentials and impedances

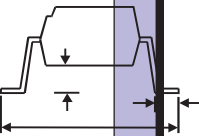

ISD2

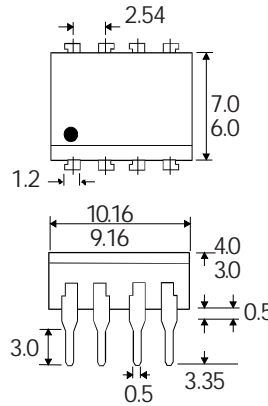

Dimensions in mm

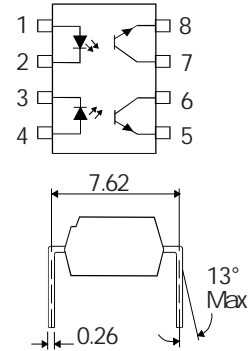

ISQ2

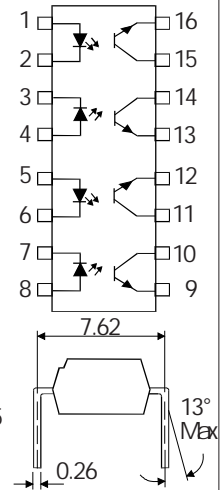
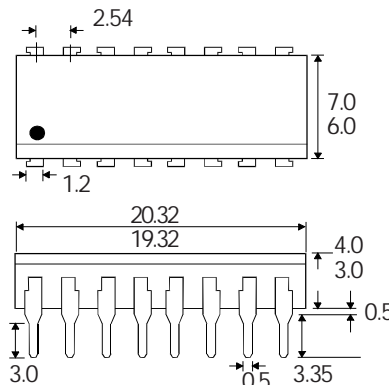

OPTION SM SURFACE MOUNT

1.2	1.4
0.6	0.9
10.2	
9.5	

OPTION G

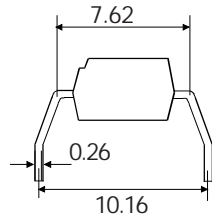

ISOCOM COMPONENTS LTD

Unit 25B, Park View Road West,
Park View Industrial Estate, Brenda Road
Hartlepool, TS25 1YD England Tel: (01429)863609
Fax : (01429) 863581 e-mail sales@isocom.co.uk
<http://www.isocom.com>

ABSOLUTE MAXIMUM RATINGS
(25°C unless otherwise specified)

Storage Temperature _____ -40°C to +125°C
 Operating Temperature _____ -25°C to +100°C
 Lead Soldering Temperature
 (1/16 inch (1.6mm) from case for 10 secs) 260°C

INPUT DIODE

Forward Current _____ 50mA
 Reverse Voltage _____ 6V
 Power Dissipation _____ 70mW

OUTPUT TRANSISTOR

Collector-emitter Voltage BV_{CEO} _____ 70V
 Emitter-collector Voltage BV_{ECO} _____ 6V
 Collector Current _____ 50mA
 Power Dissipation _____ 150mW

POWER DISSIPATION

Total Power Dissipation _____ 170mW
 (derate linearly 2.67mW/°C above 25°C)

ELECTRICAL CHARACTERISTICS ($T_A = 25^\circ\text{C}$ Unless otherwise noted)

PARAMETER		MIN	TYP	MAX	UNITS	TEST CONDITION
Input	Forward Voltage (V_F)		1.2	1.65	V	$I_F = 50\text{mA}$
	Reverse Current (I_R)			10	μA	$V_R = 4\text{V}$
Output	Collector-emitter Breakdown (BV_{CEO})	70			V	$I_C = 1\text{mA}$
	Emitter-collector Breakdown (BV_{ECO})	6			V	$I_E = 10\mu\text{A}$
	Collector-emitter Dark Current (I_{CEO})			100	nA	$V_{CE} = 20\text{V}$
Coupled	Current Transfer Ratio (CTR) (Note 2)	100		500	%	$10\text{mA } I_F, 10\text{V } V_{CE}$
	Saturated Current Transfer Ratio		170		%	$10\text{mA } I_F, 0.4\text{V } V_{CE}$
	Input to Output Isolation Voltage V_{ISO}	5300			V_{RMS}	See note 1
	Input to Output Isolation Voltage V_{ISO}	7500			V_{PK}	See note 1
	Input-output Isolation Resistance R_{ISO}	5×10^{10}			Ω	$V_{IO} = 500\text{V}$ (note 1)
	Rise Time, tr		4		μs	$I_C = 2\text{mA}$
	Fall Time, tf		3		μs	$V_{CE} = 2\text{V}, R_L = 100\Omega$

Note 1 Measured with input leads shorted together and output leads shorted together.

Note 2 Special Selections are available on request. Please consult the factory.

Collector Power Dissipation vs. Ambient Temperature

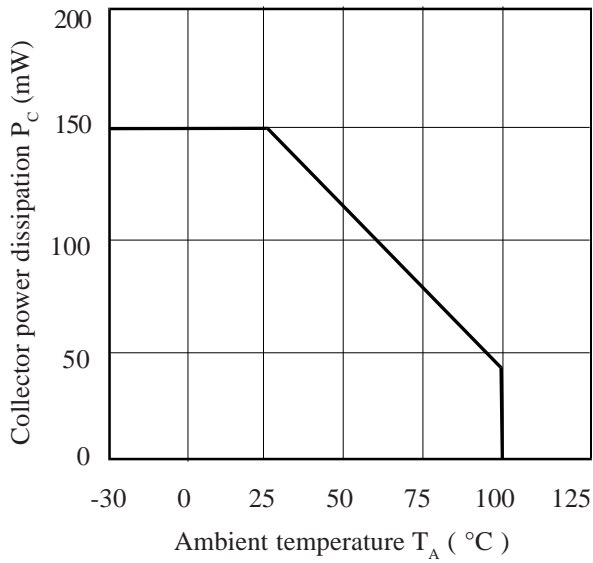

Relative Current Transfer Ratio vs. Ambient Temperature

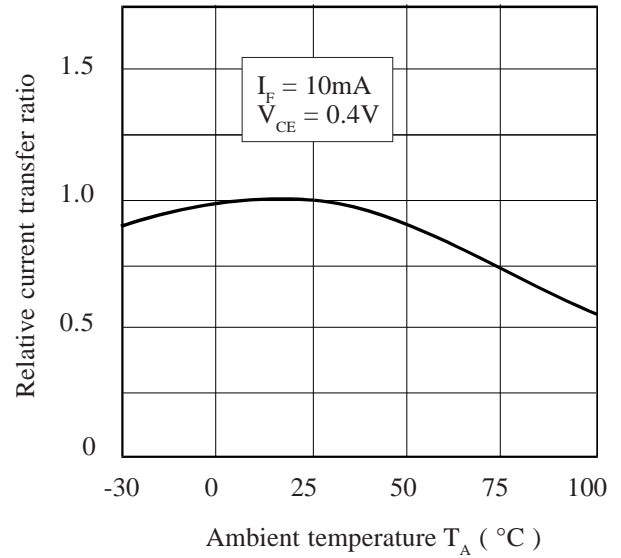

Forward Current vs. Ambient Temperature

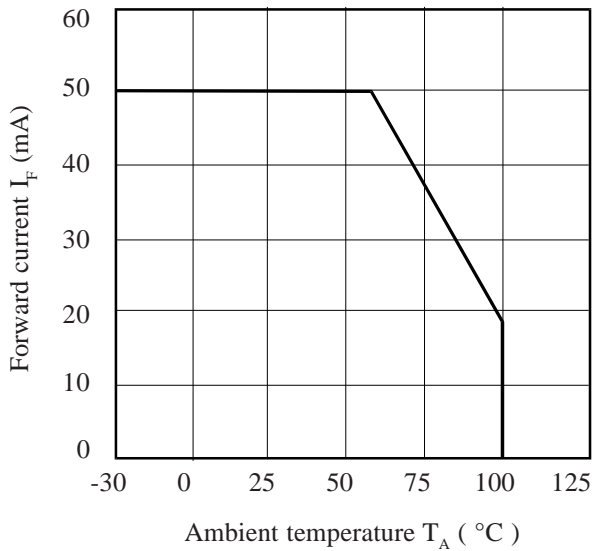

Relative Current Transfer Ratio vs. Forward Current

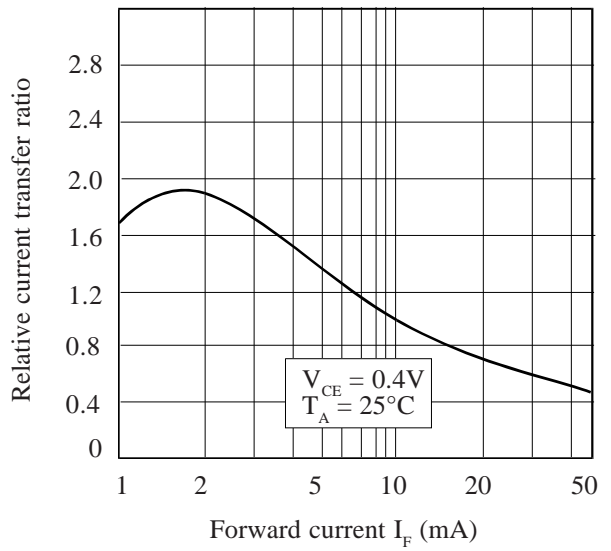

Relative Current Transfer Ratio vs. Ambient Temperature

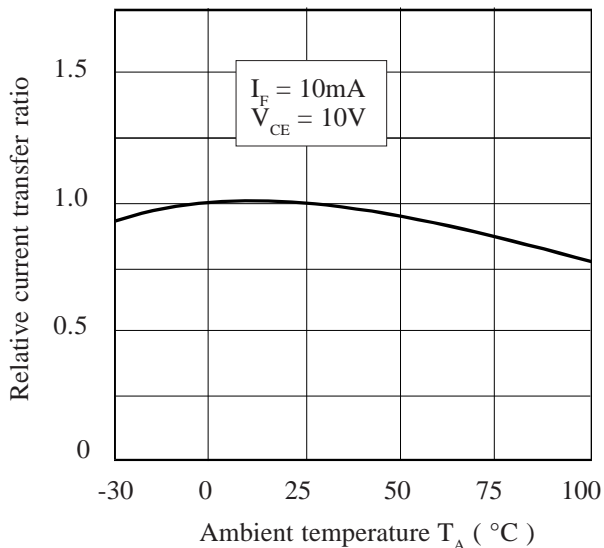

Relative Current Transfer Ratio vs. Forward Current

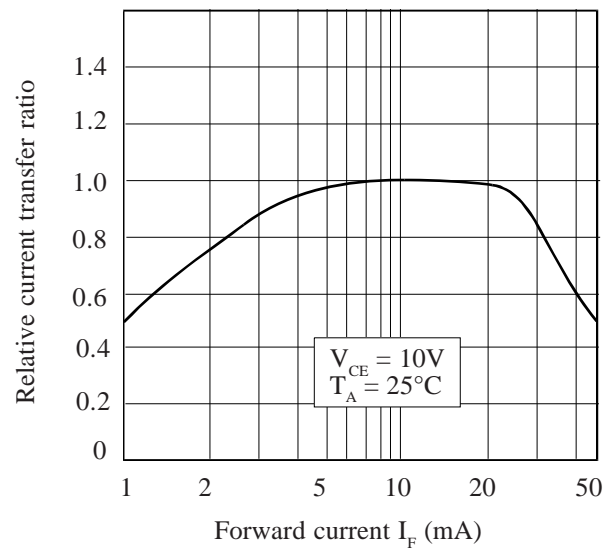

Looking for pricing, stock, or lifecycle information?

Click below to explore more details on WIN SOURCE:

- [View ISQ2X on WIN SOURCE](#)
- [Isocom Components 2004 LTD Information](#)

Optimize Your Supply Chain with WIN SOURCE Solutions

- ✓ Global Sourcing Solution
- ✓ Obsolete Management
- ✓ Cost Control Management
- ✓ Shortage Management
- ✓ Alternative Solution
- ✓ Excess Inventory Management