



# THE DATASHEET OF LDL212DR



# NEO-7

## u-blox 7 GNSS modules

### Data Sheet

#### Highlights:

- GNSS engine for GPS/QZSS, GLONASS
- Product variants to meet performance and cost requirements
- Combines low power consumption and high sensitivity
- Backward compatible with NEO-6 and NEO-5 families



[www.u-blox.com](http://www.u-blox.com)

UBX-13003830 - R07

**Document Information**

<b>Title</b>	<b>NEO-7</b>		
<b>Subtitle</b>	u-blox 7 GNSS modules		
<b>Document type</b>	Data Sheet		
<b>Document number</b>	UBX-13003830		
<b>Revision, date</b>	R07	11-Nov-2014	
<b>Document status</b>	Production Information		

**Document status explanation**

Objective Specification	Document contains target values. Revised and supplementary data will be published later.		
Advance Information	Document contains data based on early testing. Revised and supplementary data will be published later.		
Early Production Information	Document contains data from product verification. Revised and supplementary data may be published later.		
Production Information	Document contains the final product specification.		

**This document applies to the following products:**

<b>Name</b>	<b>Type number</b>	<b>ROM/FLASH version</b>	<b>PCN reference</b>
NEO-7M-0	NEO-7M-0-000	ROM1.00	N/A
NEO-7N-0	NEO-7N-0-002	FW1.00	N/A

u-blox reserves all rights to this document and the information contained herein. Products, names, logos and designs described herein may in whole or in part be subject to intellectual property rights. Reproduction, use, modification or disclosure to third parties of this document or any part thereof without the express permission of u-blox is strictly prohibited.

The information contained herein is provided "as is" and u-blox assumes no liability for the use of the information. No warranty, either express or implied, is given, including but not limited, with respect to the accuracy, correctness, reliability and fitness for a particular purpose of the information. This document may be revised by u-blox at any time. For most recent documents, visit [www.u-blox.com](http://www.u-blox.com).

Copyright © 2014, u-blox AG.

u-blox® is a registered trademark of u-blox Holding AG in the EU and other countries. ARM® is the registered trademark of ARM Limited in the EU and other countries.

# Contents

<b>Contents.....</b>	<b>3</b>
<b>1 Functional description.....</b>	<b>5</b>
1.1 Overview .....	5
1.2 Product features .....	5
1.3 GNSS performance .....	6
1.3.1 GPS performance .....	6
1.3.2 GLONASS performance .....	7
1.4 Block diagram.....	8
1.5 GNSS.....	8
1.5.1 GPS.....	8
1.5.2 GLONASS.....	8
1.5.3 Galileo.....	8
1.5.4 QZSS .....	8
1.6 Augmented GNSS.....	9
1.6.1 Assisted GNSS (A-GPS) .....	9
1.6.2 AssistNow Autonomous .....	9
1.6.3 Satellite-Based Augmentation System (SBAS).....	9
1.7 Data logging (NEO-7N) .....	9
1.8 EXTINT: External interrupt.....	10
1.8.1 Pin Control .....	10
1.8.2 Aiding .....	10
1.9 TIMEPULSE .....	10
1.10 Protocols and interfaces .....	10
1.11 Interfaces.....	11
1.11.1 UART.....	11
1.11.2 USB.....	11
1.11.3 SPI.....	11
1.11.4 Display Data Channel (DDC) .....	11
1.12 Clock generation .....	11
1.12.1 Oscillators.....	11
1.12.2 Real-Time Clock (RTC) .....	11
1.13 Power management.....	12
1.13.1 DC/DC converter .....	12
1.13.2 Operating modes .....	12
1.14 Antenna.....	12
<b>2 Pin Definition.....</b>	<b>13</b>
2.1 Pin assignment .....	13
<b>3 Configuration management.....</b>	<b>14</b>

3.1	Interface Selection (D_SEL).....	14
<b>4</b>	<b>Electrical specification.....</b>	<b>15</b>
4.1	Absolute maximum rating .....	15
4.2	Operating conditions .....	16
4.3	Indicative current requirements.....	17
4.4	SPI timing diagrams .....	18
4.4.1	Timing recommendations .....	18
4.5	DDC timing diagrams .....	18
<b>5</b>	<b>Mechanical specifications .....</b>	<b>19</b>
<b>6</b>	<b>Reliability tests and approvals .....</b>	<b>20</b>
6.1	Reliability tests .....	20
6.2	Approvals .....	20
<b>7</b>	<b>Product handling &amp; soldering.....</b>	<b>21</b>
7.1	Packaging.....	21
7.1.1	Reels .....	21
7.1.2	Tapes .....	21
7.2	Shipment, storage and handling .....	22
7.2.1	Moisture Sensitivity Levels .....	22
7.2.2	Reflow soldering .....	22
7.2.3	ESD handling precautions.....	22
<b>8</b>	<b>Default messages .....</b>	<b>23</b>
<b>9</b>	<b>Labeling and ordering information.....</b>	<b>24</b>
9.1	Product labeling.....	24
9.2	Explanation of codes.....	24
9.3	Ordering codes .....	24
	<b>Related documents.....</b>	<b>25</b>
	<b>Revision history.....</b>	<b>25</b>
	<b>Contact.....</b>	<b>26</b>

# 1 Functional description

## 1.1 Overview

The NEO-7 series of standalone GNSS modules benefit from the exceptional performance of the u-blox 7 GNSS (GPS, GLONASS, QZSS and SBAS) engine. The NEO-7 series delivers high sensitivity and minimal acquisition times in the industry-proven NEO form factor.

The NEO-7 series provides maximum sensitivity while maintaining low system power. The NEO-7M is optimized for cost sensitive applications, while NEO-7N provides best performance and easy RF integration. The NEO form factor allows easy migration from previous NEO generations. Sophisticated RF-architecture and interference suppression ensure maximum performance even in GNSS-hostile environments.

The NEO-7 series combines a high level of integration capability with flexible connectivity options in a miniature package. This makes it perfectly suited for industrial applications with strict size and cost requirements. The I<sup>2</sup>C compatible DDC interface provides connectivity and enables synergies with u-blox SARA, LEON and LISA cellular modules.

u-blox 7 modules use GNSS chips qualified according to AEC-Q100 and are manufactured in ISO/TS 16949 certified sites. Qualification tests are performed as stipulated in the ISO16750 standard: "Road vehicles – Environmental conditions and testing for electrical and electronic equipment".

## 1.2 Product features

Model	Type	Supply	Interfaces	Features	Grade
	GPS / QZSS GLONASS Galileo BeiDou Timing Dead Reckoning Precise Point Positioning Raw Data	1.65 V – 3.6 V 2.7 V – 3.6 V Lowest power (DC/DC)	UART USB SPI DDC (I <sup>2</sup> C compliant)	Programmable (Flash) Data logging Additional SAW Additional LNA RTC crystal Internal oscillator Active antenna / LNA supply Active antenna / LNA control Antenna short circuit detection / protection pin Antenna open circuit detection pin Frequency output	Standard Professional Automotive
NEO-7N	♦ ♦	♦ ♦	♦ ♦ ♦ ♦	♦ ♦ ♦ ♦ ♦ T ○ ♦	Professional
NEO-7M	♦ ♦	♦ ♦	♦ ♦ ♦ ♦	♦ C ○	Automotive

○ = Optional, not activated per default or requires external components

C = Crystal / T = TCXO

## 1.3 GNSS performance

### 1.3.1 GPS performance

Parameter	Specification		
Receiver type	56 Channels GPS L1C/A SBAS L1C/A QZSS L1C/A Galileo E1B/C <sup>1</sup>		
Time-To-First-Fix <sup>2</sup>		<b>NEO-7N</b>	<b>NEO-7M</b>
	Cold Start	29 s	30 s
	Warm Start	28 s	28 s
	Hot Start	1 s	1 s
	Aided Starts <sup>3</sup>	5 s	5 s
Sensitivity <sup>4</sup>		<b>NEO-7N</b>	<b>NEO-7M</b>
	Tracking & Navigation	-162 dBm	-161 dBm
	Reacquisition	-160 dBm	-160 dBm
	Cold Start	-148 dBm	-147 dBm
	Warm Start	-148 dBm	-148 dBm
	Hot Start	-156 dBm	-155 dBm
Horizontal position accuracy <sup>5</sup>	Autonomous	2.5 m	
	SBAS	2.0 m	
Accuracy of time pulse signal	RMS	30 ns	
	99%	60 ns	
Frequency of time pulse signal		0.25 Hz ... 10 MHz (configurable)	
Max navigation update rate		10 Hz	
Velocity accuracy <sup>6</sup>		0.1 m/s	
Heading accuracy <sup>6</sup>		0.5 degrees	
Operational limits <sup>7</sup>	Dynamics	≤ 4 g	
	Altitude	50,000 m	
	Velocity	500 m/s	

**Table 1: GPS performance**

<sup>1</sup> Ready to support Galileo E1B/C when available (NEO-7N)

<sup>2</sup> All satellites at -130 dBm

<sup>3</sup> Dependent on aiding data connection speed and latency

<sup>4</sup> Demonstrated with a good external LNA

<sup>5</sup> CEP, 50%, 24 hours static, -130 dBm, > 6 SVs

<sup>6</sup> 50% @ 30 m/s

<sup>7</sup> Assuming Airborne < 4 g platform

### 1.3.2 GLONASS performance

Parameter	Specification		
Receiver type	56 Channels GLONASS L1OF		
Time-To-First-Fix <sup>8</sup>		<b>NEO-7N</b>	<b>NEO-7M</b>
	Cold Start	30 s	32 s
	Warm Start	25 s	25 s
	Hot Start	1 s	1 s
Sensitivity <sup>9</sup>		<b>NEO-7N</b>	<b>NEO-7M</b>
	Tracking & Navigation	-158 dBm	-158 dBm
	Reacquisition	-156 dBm	-156 dBm
	Cold Start	-140 dBm	-139 dBm
	Warm Start	-145 dBm	-145 dBm
	Hot Start	-156 dBm	-155 dBm
Horizontal position accuracy <sup>10</sup>		4.0 m	
Accuracy of time pulse signal	RMS	50 ns	
	99%	100 ns	
Frequency of time pulse signal		0.25 Hz ... 10 MHz (configurable)	
Max navigation update rate		1 Hz	
Velocity accuracy <sup>11</sup>		0.1 m/s	
Heading accuracy <sup>11</sup>		0.5 degrees	
Operational limits <sup>12</sup>	Dynamics	≤ 4 g	
	Altitude	50,000 m	
	Velocity	500 m/s	

**Table 2: GLONASS performance**

<sup>8</sup> All satellites at -130 dBm

<sup>9</sup> Demonstrated with a good external LNA

<sup>10</sup> CEP, 50%, 24 hours static, -130 dBm, > 6 SVs

<sup>11</sup> 50% @ 30 m/s

<sup>12</sup> Assuming Airborne < 4 g platform

## 1.4 Block diagram

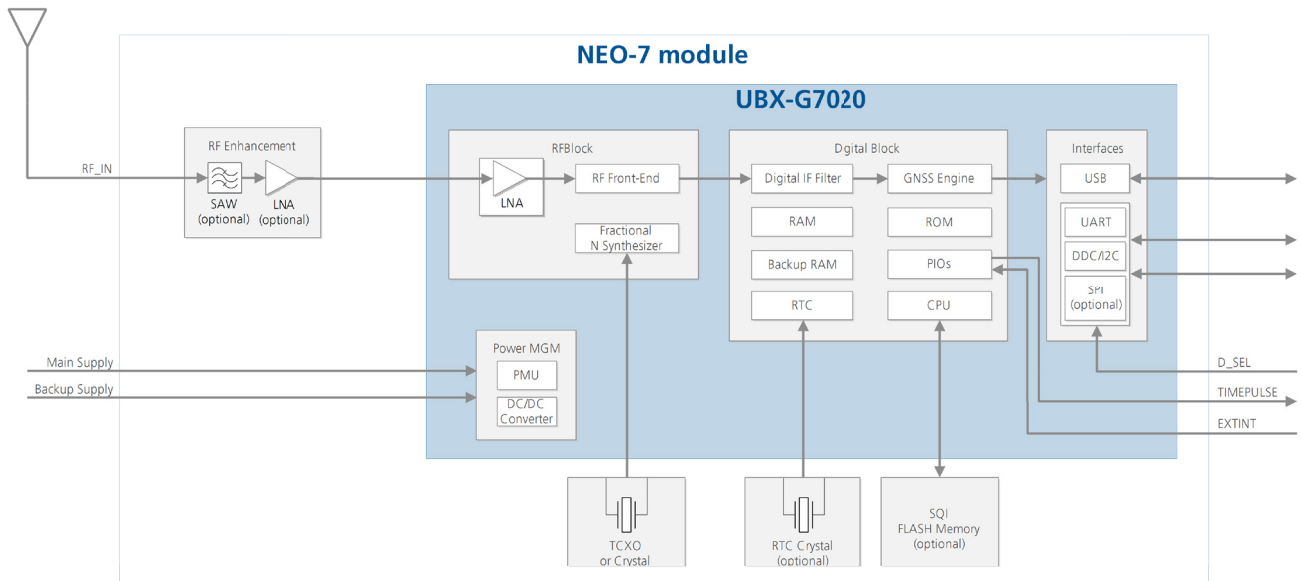

Figure 1: NEO-7 block diagram

## 1.5 GNSS

u-blox 7 positioning modules are GNSS receivers and can singly receive and track GPS, GLONASS, or Galileo signals. QZSS signals may be received concurrently with GPS signals.

### 1.5.1 GPS

u-blox 7 receivers are designed to receive and track the L1C/A signals provided at 1575.42 MHz by the Global Positioning System (GPS).

### 1.5.2 GLONASS

The Russian GLONASS satellite system is an alternative system to the US-based Global Positioning System (GPS). The u-blox 7 module is capable of receiving and processing GLONASS signals using the same hardware and provides the lowest power GLONASS functionality in the industry at low cost and with minimal integration effort. In order to take advantage of GPS and GLONASS, dedicated hardware preparation must be taken during the design-in phase, see the *MAX-7 / NEO-7 Hardware Integration Manual* [1] for u-blox design recommendations.

The ability to receive and track GLONASS L1OF satellite signals with the same hardware results in an optimized hardware BOM and allows design of GLONASS ready receivers where required by regulations.

Note: GLONASS and GPS signals cannot be received and tracked simultaneously by u-blox 7 modules.

### 1.5.3 Galileo

When Galileo-L1 signals become available, u-blox 7 flash-based receivers will be capable of receiving and processing them via a firmware upgrade. The ability to receive and track Galileo satellite signals will result in higher coverage, improved reliability and better accuracy.

### 1.5.4 QZSS

The Quasi-Zenith Satellite System (QZSS) is a navigation satellite overlay system for the Pacific region covering Japan and Australia which transmits additional GPS L1C/A signals. u-blox 7 positioning modules are able to

receive and to track these signals simultaneously with GPS, resulting in better availability, especially under bad signal conditions e.g. in urban canyons.

## 1.6 Augmented GNSS



For more details about augmented GNSS, see the *u-blox 7 Receiver Description Including Protocol Specification* [2].

### 1.6.1 Assisted GNSS (A-GPS)

A-GPS improves GNSS performance by delivering aiding data to the GNSS receiver via wireless networks or the Internet. Supplying information such as ephemeris, almanac, approximate last position, time and satellite status and an optional time synchronization signal significantly reduces Time to First Fix (TTFF) and improves acquisition sensitivity.

AssistNow Online and AssistNow Offline are u-blox' end-to-end A-GPS services for devices with or without network connectivity. AssistNow Online and AssistNow Offline can either be used alone or in combination. They are very easy to implement, require no additional hardware, and generate virtually no CPU load. All u-blox 7 modules support u-blox' AssistNow Online, AssistNow Offline and AssistNow Autonomous A-GPS services, and are OMA SUPL compliant.

#### AssistNow Online

With AssistNow Online, an internet-connected GNSS device downloads assistance data from u-blox' AssistNow Online Service at system start-up. AssistNow Online is network operator independent and globally available. u-blox only sends ephemeris data for those satellites currently visible to the device requesting the data, thus minimizing the amount of data transferred.

#### AssistNow Offline

With AssistNow Offline, users download u-blox' Differential Almanac Correction Data from the Internet at their convenience. The correction data can either be stored in the GNSS receiver's Flash memory (available on NEO-7N only) or in the memory of the application processor. Therefore, the service requires no connectivity at system start-up and enables a position fix within seconds, even when no network is available.

### 1.6.2 AssistNow Autonomous

AssistNow Autonomous provides functionality similar to Assisted-GNSS without the need for a host or external network connection. It is an embedded feature available free-of-charge that accelerates GNSS positioning by capitalizing on the periodic nature of GNSS satellite orbits. GNSS orbit predictions are directly calculated by the GNSS receiver and no external aiding data or connectivity is required. AssistNow Autonomous can be used alone, or together with AssistNow Online or AssistNow Offline for increased positioning speed and accuracy.

### 1.6.3 Satellite-Based Augmentation System (SBAS)

u-blox 7 positioning modules support SBAS. These systems supplement GNSS data with additional regional or wide area GNSS augmentation data. The system broadcasts augmentation data via satellite which can be used by GNSS receivers to improve the resulting GNSS precision. SBAS satellites can be used as additional satellites for ranging (navigation), further enhancing precision. The following SBAS are supported with u-blox 7: WAAS, EGNOS and MSAS.

## 1.7 Data logging (NEO-7N)

New with u-blox 7 is the data logging feature, which enables continuous storage of position, velocity and time information to an internal 16Mbit SQI FLASH memory. The information can be downloaded from the receiver later for further analysis or for conversion to a mapping tool. For more information see the *u-blox 7 Receiver Description Including Protocol Specification* [2].

## 1.8 EXTINT: External interrupt

EXTINT is an external interrupt pin with fixed input voltage thresholds with respect to VCC. It can be used for control of the receiver or for aiding.

For more information about how to implement and configure these features see the *u-blox 7 Receiver Description including Protocol Specification* [2] and the *MAX-7 / NEO-7 Hardware Integration Manual* [1].

### 1.8.1 Pin Control

The pin control feature allows overriding the automatic active/inactive cycle of Power Save Mode. The state of the receiver can be controlled through the EXTINT pin.

The receiver can also be forced OFF using EXTINT when Power Save Mode is not active.

### 1.8.2 Aiding

The EXTINT pin can be used to supply time or frequency aiding data to the receiver.

For time aiding, hardware time synchronization can be achieved by connecting an accurate time pulse to the EXTINT pin.

Frequency aiding can be implemented by connecting a periodic rectangular signal with a frequency up to 500 kHz and arbitrary duty cycle (low/high phase duration must not be shorter than 50 ns) to the EXTINT pin. Provide the applied frequency value to the receiver using UBX messages.

## 1.9 TIMEPULSE

A configurable time pulse signal is available with all u-blox 7 modules.

The TIMEPULSE output generates pulse trains synchronized with GNSS or UTC time grid with intervals configurable over a wide frequency range. Thus it may be used as a low frequency time synchronization pulse or as a high frequency reference signal.

By default the time pulse signal is configured to 1 pulse per second. For more information see the *u-blox 7 Receiver Description including Protocol Specification* [2].

## 1.10 Protocols and interfaces

Protocol	Type
NMEA	Input/output, ASCII, 0183, 2.3 (compatible to 3.0)
UBX	Input/output, binary, u-blox proprietary
RTCM	Input, 2.3

**Table 3: Available Protocols**

All protocols are available on UART, USB, DDC (I<sup>2</sup>C compliant) and SPI. For specification of the various protocols see the *u-blox 7 Receiver Description Including Protocol Specification* [2].

## 1.11 Interfaces

A number of interfaces are provided either for data communication or memory access. The embedded firmware uses these interfaces according to their respective protocol specifications.

### 1.11.1 UART

NEO-7 modules include one UART interface, which can be used for communication to a host. It supports configurable baud rates. For supported baud rates see the *u-blox 7 Receiver Description Including Protocol Specification* [2].

### 1.11.2 USB

A USB version 2.0 FS compatible interface can be used for communication as an alternative to the UART. The pull-up resistor on pin USB\_DP is integrated to signal a full-speed device to the host. The VDD\_USB pin supplies the USB interface.

u-blox provides a Microsoft® certified USB driver for Windows XP, Windows Vista and Windows 7 operating systems.

### 1.11.3 SPI

The SPI interface is designed to allow communication to a host CPU. The interface can be operated in slave mode only. The maximum transfer rate using SPI is 1 Mb/s and the maximum SPI clock frequency is 5.5 MHz. Note that SPI is not available in the default configuration, because its pins are shared with the UART and DDC interfaces. The SPI interface can be enabled by connecting D\_SEL (Pin 2) to ground (see section 3.1).

### 1.11.4 Display Data Channel (DDC)

An I<sup>2</sup>C compliant DDC interface is available for communication with an external host CPU or u-blox cellular modules. The interface can be operated in slave mode only. The DDC protocol and electrical interface are fully compatible with Fast-Mode of the I<sup>2</sup>C industry standard. Since the maximum SCL clock frequency is 400 kHz, the maximum transfer rate is 400 kb/s.

## 1.12 Clock generation

### 1.12.1 Oscillators

NEO-7 GNSS modules are available in Crystal and TCXO versions. The TCXO allows accelerated weak signal acquisition, enabling faster start and reacquisition times.

### 1.12.2 Real-Time Clock (RTC)

The RTC is driven by a 32 kHz oscillator, which makes use of an RTC crystal. If the main supply voltage fails, and a battery is connected to V\_BCKP, parts of the receiver switch off, but the RTC still runs providing a timing reference for the receiver. This operating mode is called Hardware Backup Mode, which enables all relevant data to be saved in the backup RAM to later allow a hot or warm start.

## 1.13 Power management

u-blox 7 technology offers a power-optimized architecture with built-in autonomous power saving functions to minimize power consumption at any given time. An integrated high efficiency DC/DC converter allows low power consumption even for higher main supply voltages. The receiver can be operated in two operating modes: Continuous Mode or Power Save Mode.

 For more information about power management strategies, see the *u-blox 7 Receiver Description Including Protocol Specification* [2].

### 1.13.1 DC/DC converter

NEO-7 Modules integrate a DC/DC converter, allowing reduced power consumption especially when using a main supply voltage above 2.5 V.

 For more information see the *MAX-7 / NEO-7 Hardware Integration Manual* [1]

### 1.13.2 Operating modes

u-blox 7 modules have two operating modes:

- Continuous Mode for best GNSS performance
- Power Save Mode to optimize power consumption

#### 1.13.2.1 Continuous Mode

Continuous Mode uses the acquisition engine at full performance resulting in the shortest possible TTFF and the highest sensitivity. It searches for all possible satellites until the Almanac is completely downloaded. The receiver then switches to the tracking engine to lower power consumption.

Thus, a lower tracking current consumption level will be achieved when:

- A valid GNSS position is obtained
- The entire Almanac has been downloaded
- The Ephemeris for each satellite in view is valid

#### 1.13.2.2 Power Save Mode

For power sensitive applications, u-blox 7 receivers provide a Power Save Mode for reduced power consumption. Power Save Mode uses two dedicated operations called ON/OFF and Cyclic tracking, that reduce average current consumption in different ways to match the needs of the specific application. These operations can be set by using a specific ubx message.

 Power Save Mode is not available in GLONASS mode.

## 1.14 Antenna

NEO-7 modules are designed for use with passive<sup>13</sup> and active<sup>14</sup> antennas.

Parameter	Specification	
Antenna Type	Passive and active antenna	
Active Antenna Recommendations	Minimum gain	15 dB (to compensate signal loss in RF cable)
	Maximum gain	50 <sup>15</sup> dB / 30 <sup>16</sup> dB
	Maximum noise figure	1.5 dB

**Table 4: Antenna Specifications for all NEO-7 modules**

<sup>13</sup> For integration NEO-7 modules with Cellular products, see the *MAX-7 / NEO-7 Hardware Integration Manual* [1].

<sup>14</sup> For information on using active antennas with NEO-7 modules, see the *MAX-7 / NEO-7 Hardware Integration Manual* [1].

<sup>15</sup> NEO-7M

<sup>16</sup> NEO-7N

## 2 Pin Definition

### 2.1 Pin assignment

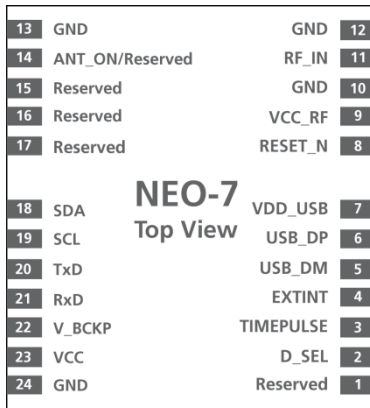

Figure 2: Pin Assignment

No	Module	Name	I/O	Description
1	All	Reserved	I	Reserved
2	All	D_SEL	I	Interface select
3	All	TIMEPULSE	O	Time pulse (1PPS)
4	All	EXTINT	I	External Interrupt Pin
5	All	USB_DM	I/O	USB Data
6	All	USB_DP	I/O	USB Data
7	All	VDD_USB	I	USB Supply
8	All	RESET_N	I	RESET_N
9	All	VCC_RF	O	Output Voltage RF section
10	All	GND	I	Ground
11	All	RF_IN	I	GNSS signal input
12	All	GND	I	Ground
13	All	GND	I	Ground
14	NEO-7N	ANT_ON	O	Antenna control
	NEO-7M	Reserved	-	Reserved
15	All	Reserved	-	Reserved
16	All	Reserved	-	Reserved
17	All	Reserved	-	Reserved
18	All	SDA SPI CS_N	I/O	DDC Data if D_SEL =1 (or open) SPI Chip Select if D_SEL = 0
19	All	SCL SPI CLK	I/O	DDC Clock if D_SEL =1(or open) SPI Clock if D_SEL = 0
20	All	TxD SPI MISO	O	Serial Port if D_SEL =1(or open) SPI MISO if D_SEL = 0
21	All	RxD SPI MOSI	I	Serial Port if D_SEL =1(or open) SPI MOSI if D_SEL = 0
22	All	V_BCKP	I	Backup voltage supply
23	All	VCC	I	Supply voltage
24	All	GND	I	Ground

Table 5: Pinout



Pins designated Reserved should not be used. For more information about Pinouts see the *MAX-7 / NEO-7 Hardware Integration Manual* [1].

## 3 Configuration management

Configuration settings can be modified with UBX configuration messages. The modified settings remain effective until power-down or reset. If these settings have been stored in battery-backup RAM, then the modified configuration will be retained, as long as the backup battery supply is not interrupted.

With the NEO-7N, configuration settings modified with UBX configuration messages can be saved permanently. In this case, the modified settings remain effective even after power-down and do not require backup battery supply.

### 3.1 Interface Selection (D\_SEL)

At startup the Pin 2 (D\_SEL) determines which data interfaces are used for communication. If D\_SEL is set high or left open, UART and DDC become available. If D\_SEL is set low, i.e. connected to ground, the NEO Module can communicate to a host via SPI.

PIN #	D_SEL="1" (left open)	D_SEL = "0" (connected to GND)
20	UART TX	SPI MISO
21	UART RX	SPI MOSI
19	DDC SCL	SPI CLK
18	DDC SDA	SPI CS_N

**Table 6: Data interface selection by D\_SEL**

## 4 Electrical specification



The limiting values given are in accordance with the Absolute Maximum Rating System (IEC 134). Stress above one or more of the limiting values may cause permanent damage to the device. These are stress ratings only and operation of the device at these or at any other conditions above those given in the Characteristics sections of the specification is not implied. Exposure to these limits for extended periods may affect device reliability.



Where application information is given, it is advisory only and does not form part of the specification. For more information see the *MAX-7 / NEO-7 Hardware Integration Manual* [1].

### 4.1 Absolute maximum rating

Parameter	Symbol	Module	Condition	Min	Max	Units
Power supply voltage	VCC	All		-0.5	3.6	V
Backup battery voltage	V_BCKP	All		-0.5	3.6	V
USB supply voltage	VDD_USB	All		-0.5	3.6	V
Input pin voltage	Vin	All		-0.5	3.6	V
	Vin_usb	All		-0.5	VDD_USB	V
DC current through any digital I/O pin (except supplies)	Ipin				10	mA
VCC_RF output current	ICC_RF	All			100	mA
Input power at RF_IN	Prfin	All	source impedance = 50 Ω, continuous wave		13	dBm
Storage temperature	Tstg	All		-40	85	°C

**Table 7: Absolute maximum ratings**



**Stressing the device beyond the “Absolute Maximum Ratings” may cause permanent damage. These are stress ratings only. The product is not protected against overvoltage or reversed voltages. If necessary, voltage spikes exceeding the power supply voltage specification, given in table above, must be limited to values within the specified boundaries by using appropriate protection diodes.**

## 4.2 Operating conditions



All specifications are at an ambient temperature of 25°C. Extreme operating temperatures can significantly impact specification values. Applications operating near the temperature limits should be tested to ensure the specification.

Parameter	Symbol	Module	Min	Typical	Max	Units	Condition
Power supply voltage	VCC	NEO-7M	1.65		3.6	V	
		NEO-7N	2.7	3.0	3.6	V	
Supply voltage USB	VDDUSB	All	3.0	3.3	3.6	V	
Backup battery voltage	V_BCKP	All	1.4		3.6	V	
Backup battery current	I_BCKP	All		15		μA	V_BCKP = 1.8 V, VCC = 0 V
SW backup current	I_SWBCKP	NEO-7M		20		μA	VCC = 3 V
		NEO-7N		35		μA	VCC = 3 V
Input pin voltage range	Vin	All	0		VCC	V	
Digital IO Pin Low level input voltage	Vil	All	0		0.2*VCC	V	
Digital IO Pin High level input voltage	Vih	All	0.7*VCC		VCC	V	
Digital IO Pin Low level output voltage	Vol	All			0.4	V	Iol = 4 mA
Digital IO Pin High level output voltage	Voh	All	VCC -0.4			V	Ioh = 4 mA
USB_DM, USB_DP	VinU	All	Compatible with USB with 22 Ω series resistance				
VCC_RF voltage	VCC_RF	All		VCC-0.1		V	
VCC_RF output current	ICC_RF	All			50	mA	
Receiver Chain Noise Figure	NFtot	NEO-7M		3.5		dB	
		NEO-7N		2.0		dB	
Operating temperature	Topr	All	-40		85	°C	

**Table 8: Operating conditions**



Operation beyond the specified operating conditions can affect device reliability.

### 4.3 Indicative current requirements

Table 9 lists examples of the total system supply current for a possible application.



Values in Table 9 are provided for customer information only as an example of typical power requirements. Values are characterized on samples, actual power requirements can vary depending on FW version used, external circuitry, number of SVs tracked, signal strength, type of start as well as time, duration and conditions of test.

Parameter	Symbol	Module	Min	Typ	Max	Units	Condition
Max. supply current <sup>17</sup>	lccp	All			67	mA	
		NEO-7N		32			Estimated at 3V
Average supply current <sup>18, 19</sup>	lcc Acquisition <sup>20</sup>	NEO-7M		22		mA	Estimated at 3V
		NEO-7N		26			
	lcc Tracking (Continuous mode,)	NEO-7N		17		mA	Estimated at 3V
		NEO-7M		11			
lcc Tracking (Power Save mode / 1 Hz)	NEO-7N		5		mA	Estimated at 3V	
	NEO-7M						

**Table 9: Indicative power requirements at 3.0 V**



For more information about power requirements, see the *MAX-7 / NEO-7 Hardware Integration Manual* [1]

<sup>17</sup> Use this figure to dimension maximum current capability of power supply. Measurement of this parameter with 1 Hz bandwidth.

<sup>18</sup> Use this figure to determine required battery capacity.

<sup>19</sup> Simulated constellation of 8 satellites is used. All signals are at -130 dBm.

<sup>20</sup> Average current from start-up until the first fix.

## 4.4 SPI timing diagrams

In order to avoid incorrect operation of the SPI, the user needs to comply with certain timing conditions. The following signals need to be considered for timing constraints:

Symbol	Description
SPI CS_N (SS_N)	Slave select signal
SPI CLK (SCK)	Slave clock signal

Table 10: Symbol description

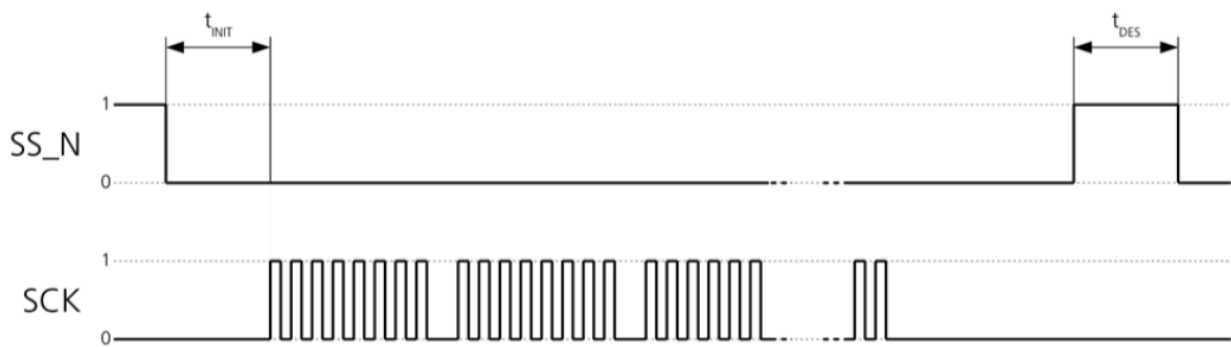

Figure 3: SPI timing diagram

### 4.4.1 Timing recommendations

The recommendations below are based on a firmware running from Flash memory.

Parameter	Description	Recommendation
$t_{INIT}$	Initialization Time	500 $\mu$ s
$t_{DES}$	Deselect Time	1 ms.
Bit rate		1 Mb/s

Table 11: SPI timing recommendations

The values in the above table result from the requirement of an error-free transmission. By allowing just a few errors and disabling the glitch filter, the bit rate can be increased considerably.

## 4.5 DDC timing diagrams

The DDC interface is I<sup>2</sup>C Fast Mode compliant. For timing parameters consult the I<sup>2</sup>C standard.

The maximum bit rate is 400 kb/s. The interface stretches the clock when slowed down when serving interrupts, so real bit rates may be slightly lower.

## 5 Mechanical specifications

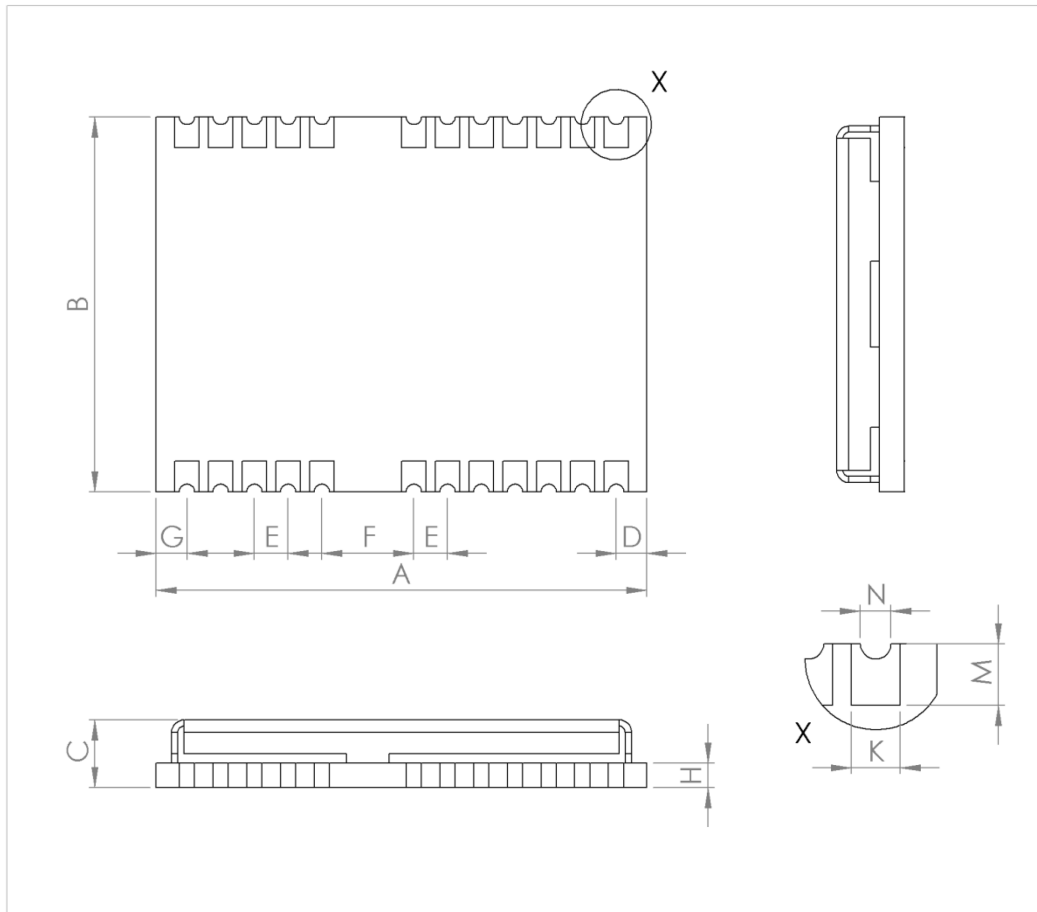

Symbol	Min. (mm)	Typ. (mm)	Max. (mm)
A	15.9	16.0	16.6
B	12.1	12.2	12.3
C	2.2	2.4	2.6
D	0.9	1.0	1.3
E	1.0	1.1	1.2
F	2.9	3.0	3.1
G	0.9	1.0	1.3
H		0.82	
K	0.7	0.8	0.9
M	0.8	0.9	1.0
N	0.4	0.5	0.6
Weight		1.6g	

Figure 4: Dimensions



For information regarding the Paste Mask and Footprint see the *MAX-7 / NEO-7 Hardware Integration Manual [1]*.

## 6 Reliability tests and approvals

### 6.1 Reliability tests



All NEO-7 modules are based on AEC-Q100 qualified GNSS chips.

Tests for product family qualifications are according to ISO 16750 "Road vehicles – Environmental conditions and testing for electrical and electronic equipment", and appropriate standards.

### 6.2 Approvals



Products marked with this lead-free symbol on the product label comply with the "Directive 2002/95/EC of the European Parliament and the Council on the Restriction of Use of certain Hazardous Substances in Electrical and Electronic Equipment" (RoHS).

All u-blox 7 GNSS modules are RoHS compliant.

# 7 Product handling & soldering

## 7.1 Packaging

NEO-7 modules are delivered as hermetically sealed, reeled tapes in order to enable efficient production, production lot set-up and tear-down. For more information see the *u-blox Package Information Guide* [3].

### 7.1.1 Reels

NEO-7 GNSS modules are deliverable in quantities of 250pcs on a reel. NEO-7 modules are shipped on Reel Type B, as specified in the *u-blox Package Information Guide* [3].

### 7.1.2 Tapes

The dimensions and orientations of the tapes for NEO-7 modules are specified in Figure 5.

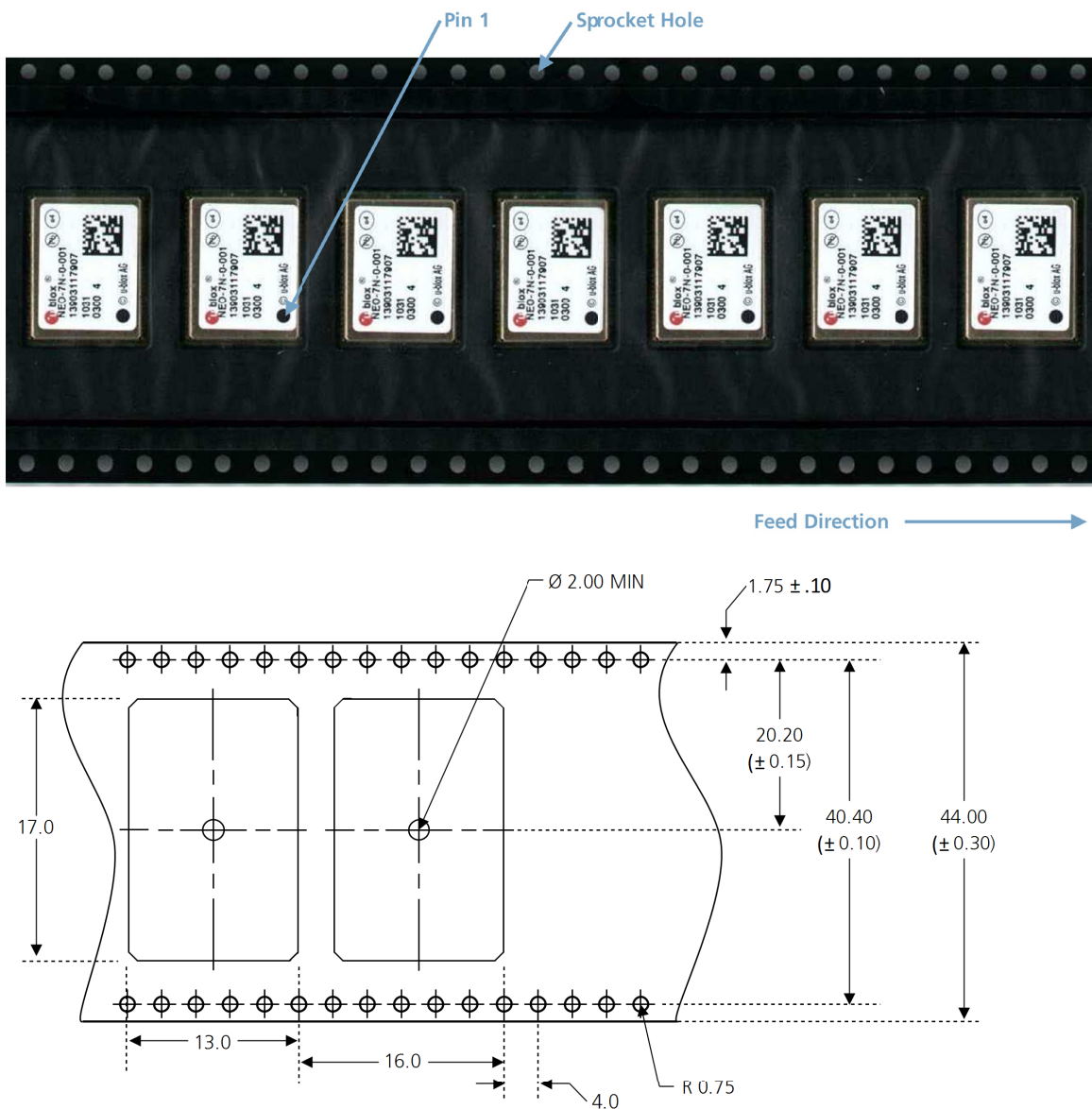



Figure 5: Dimensions and orientation for NEO-7 modules on tape

## 7.2 Shipment, storage and handling

For important information regarding shipment, storage and handling see the *u-blox Package Information Guide* [3].

### 7.2.1 Moisture Sensitivity Levels

The Moisture Sensitivity Level (MSL) relates to the packaging and handling precautions required. NEO-7 modules are rated at MSL level 4.

 For MSL standard see IPC/JEDEC J-STD-020, which can be downloaded from [www.jedec.org](http://www.jedec.org).

### 7.2.2 Reflow soldering

Reflow profiles are to be selected according u-blox recommendations (see the *MAX-7 / NEO-7 Hardware Integration Manual* [1]).

### 7.2.3 ESD handling precautions

 **NEO-7 modules are Electrostatic Sensitive Devices (ESD). Observe precautions for handling! Failure to observe these precautions can result in severe damage to the GNSS receiver!**

GNSS receivers are Electrostatic Sensitive Devices (ESD) and require special precautions when handling. Particular care must be exercised when handling patch antennas, due to the risk of electrostatic charges. In addition to standard ESD safety practices, the following measures should be taken into account whenever handling the receiver:

- Unless there is a galvanic coupling between the local GND (i.e. the work table) and the PCB GND, then the first point of contact when handling the PCB must always be between the local GND and PCB GND.
- Before mounting an antenna patch, connect ground of the device
- When handling the RF pin, do not come into contact with any charged capacitors and be careful when contacting materials that can develop charges (e.g. patch antenna ~10 pF, coax cable ~50-80 pF/m, soldering iron, ...)
- To prevent electrostatic discharge through the RF input, do not touch any exposed antenna area. If there is any risk that such exposed antenna area is touched in non ESD protected work area, implement proper ESD protection measures in the design.
- When soldering RF connectors and patch antennas to the receiver's RF pin, make sure to use an ESD safe soldering iron (tip).



## 8 Default messages

Interface	Settings
UART Output	9600 Baud, 8 bits, no parity bit, 1 stop bit Configured to transmit both NMEA and UBX protocols, but only the following NMEA (and no UBX) messages have been activated at start-up: <b>GGA, GLL, GSA, GSV, RMC, VTG, TXT</b>
USB Output	Configured to transmit both NMEA and UBX protocols, but only the following NMEA (and no UBX) messages have been activated at start-up: <b>GGA, GLL, GSA, GSV, RMC, VTG, TXT</b> USB Power Mode: Bus Powered
UART Input	9600 Baud, 8 bits, no parity bit, 1 stop bit, Autobauding disabled Automatically accepts following protocols without need of explicit configuration: UBX, NMEA The GNSS receiver supports interleaved UBX and NMEA messages.
USB Input	Automatically accepts following protocols without need of explicit configuration: UBX, NMEA The GNSS receiver supports interleaved UBX and NMEA messages. USB Power Mode: Bus Powered
TIMEPULSE (1 Hz Nav)	1 pulse per second, synchronized at rising edge, pulse length 100ms

**Table 12: Default messages**



Refer to the *u-blox 7 Receiver Description Including Protocol Specification* [2] for information about further settings.

## 9 Labeling and ordering information

### 9.1 Product labeling

The labeling of u-blox 7 GNSS modules includes important product information. The location of the product type number is shown in Figure 6.

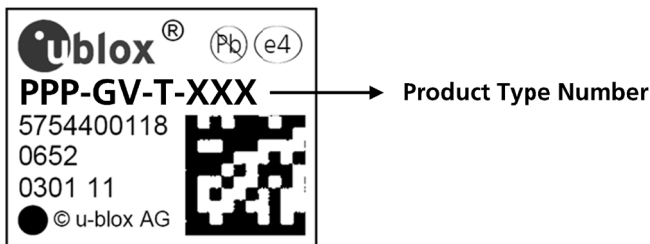

Figure 6: Location of product type number on u-blox 7 module label

### 9.2 Explanation of codes

3 different product code formats are used. The **Product Name** is used in documentation such as this data sheet and identifies all u-blox 7 products, independent of packaging and quality grade. The **Ordering Code** includes options and quality, while the **Type Number** includes the hardware and firmware versions. Table 13 below details these 3 different formats:

Format	Structure
Product Name	PPP-GV
Ordering Code	PPP-GV-T
Type Number	PPP-GV-T-XXX

Table 13: Product Code Formats

The parts of the product code are explained in Table 14.

Code	Meaning	Example
PPP	Product Family	NEO
G	Product Generation	7 = u-blox7
V	Variant	T = Timing, R = DR, etc.
T	Option / Quality Grade	Describes standardized functional element or quality grade such as Flash size, automotive grade etc.
XXX	Product Detail	Describes product details or options such as hard- and software revision, cable length, etc.

Table 14: part identification code

### 9.3 Ordering codes

Ordering No.	Product
NEO-7M-0	u-blox 7 GNSS Module, ROM, Crystal, 12.2x16 mm, 250 pcs/reel
NEO-7N-0	u-blox 7 GNSS Module, Flash, TCXO, SAW, LNA, 12.2x16 mm, 250 pcs/reel

Table 15: Product ordering codes for professional grade modules



Product changes affecting form, fit or function are documented by u-blox. For a list of Product Change Notifications (PCNs) see our website.

## Related documents

- [1] MAX-7 / NEO-7 Hardware Integration Manual, Docu. No. UBX-13003704
- [2] u-blox 7 Receiver Description including Protocol Specification, Docu. No GPS.G7-SW-12001
- [3] u-blox Package Information Guide, Docu. No. UBX-14001652

## Revision history

Revision	Date	Name	Status / Comments
-	28-Aug-2012	dhur/cbib	Initial release
1	18-Feb-2013	dhur/cbib	Updated section 1.5. Corrected table 6. Last revision with document number GPS.G7-HW-11004
R03	30-Jan-2014	dhur	Changed status to Early Production Information
R04	06-Feb-2014	smos	Corrected product type table on page 2.
R05	12-May-2014	julu	Aligned product selector table in section 1.2; updated Figure 1 (removed I/O supply from the Block Diagram); added recommendation for using passive antenna in Table 4; added SW backup current figures in Table 8.
R06	19-May-2014	julu	Changed status to Production Information
R07	11-Nov-2014	julu	Updated section 1.2 (added product grade information to selector table)

# Contact

For complete contact information visit us at [www.u-blox.com](http://www.u-blox.com)

## u-blox Offices

### North, Central and South America

#### u-blox America, Inc.

Phone: +1 703 483 3180  
E-mail: [info\\_us@u-blox.com](mailto:info_us@u-blox.com)

#### Regional Office West Coast:

Phone: +1 408 573 3640  
E-mail: [info\\_us@u-blox.com](mailto:info_us@u-blox.com)

#### Technical Support:

Phone: +1 703 483 3185  
E-mail: [support\\_us@u-blox.com](mailto:support_us@u-blox.com)

### Headquarters Europe, Middle East, Africa

#### u-blox AG

Phone: +41 44 722 74 44  
E-mail: [info@u-blox.com](mailto:info@u-blox.com)  
Support: [support@u-blox.com](mailto:support@u-blox.com)

### Asia, Australia, Pacific

#### u-blox Singapore Pte. Ltd.

Phone: +65 6734 3811  
E-mail: [info\\_ap@u-blox.com](mailto:info_ap@u-blox.com)  
Support: [support\\_ap@u-blox.com](mailto:support_ap@u-blox.com)

#### Regional Office Australia:

Phone: +61 2 8448 2016  
E-mail: [info\\_anz@u-blox.com](mailto:info_anz@u-blox.com)  
Support: [support\\_ap@u-blox.com](mailto:support_ap@u-blox.com)

#### Regional Office China (Beijing):

Phone: +86 10 68 133 545  
E-mail: [info\\_cn@u-blox.com](mailto:info_cn@u-blox.com)  
Support: [support\\_cn@u-blox.com](mailto:support_cn@u-blox.com)

#### Regional Office China (Shenzhen):

Phone: +86 755 8627 1083  
E-mail: [info\\_cn@u-blox.com](mailto:info_cn@u-blox.com)  
Support: [support\\_cn@u-blox.com](mailto:support_cn@u-blox.com)

#### Regional Office India:

Phone: +91 959 1302 450  
E-mail: [info\\_in@u-blox.com](mailto:info_in@u-blox.com)  
Support: [support\\_in@u-blox.com](mailto:support_in@u-blox.com)

#### Regional Office Japan:

Phone: +81 3 5775 3850  
E-mail: [info\\_jp@u-blox.com](mailto:info_jp@u-blox.com)  
Support: [support\\_jp@u-blox.com](mailto:support_jp@u-blox.com)

#### Regional Office Korea:



Phone: +82 2 542 0861  
E-mail: [info\\_kr@u-blox.com](mailto:info_kr@u-blox.com)  
Support: [support\\_kr@u-blox.com](mailto:support_kr@u-blox.com)

#### Regional Office Taiwan:







Phone: +886 2 2657 1090  
E-mail: [info\\_tw@u-blox.com](mailto:info_tw@u-blox.com)  
Support: [support\\_tw@u-blox.com](mailto:support_tw@u-blox.com)

## Looking for pricing, stock, or lifecycle information?

Click below to explore more details on WIN SOURCE:

-  [View LDL212DR](#) on WIN SOURCE
-  [STMicroelectronics](#) Information

## Optimize Your Supply Chain with WIN SOURCE Solutions

-  Global Sourcing Solution
-  Obsolete Management
-  Cost Control Management
-  Shortage Management
-  Alternative Solution
-  Excess Inventory Management