



**THE DATASHEET OF
LM4128AMF-3.0**



LM4128/LM4128Q

SOT-23 Precision Micropower Series Voltage Reference

General Description

Ideal for space critical applications, the LM4128 precision voltage reference is available in the SOT-23 surface-mount package. The LM4128's advanced design eliminates the need for an external stabilizing capacitor while ensuring stability with capacitive loads up to 10 μF , thus making the LM4128 easy to use.

Series references provide lower power consumption than shunt references, since they do not have to idle the maximum possible load current under no load conditions. This advantage, the low quiescent current (60 μA), and the low dropout voltage (400 mV) make the LM4128 ideal for battery-powered solutions.

The LM4128 is available in four grades (A, B, C, and D) for greater flexibility. The best grade devices (A) have an initial accuracy of 0.1% with guaranteed temperature coefficient of 75 ppm/ $^{\circ}\text{C}$ or less, while the lowest grade parts (D) have an initial accuracy of 1.0% and a tempco of 100 ppm/ $^{\circ}\text{C}$.

Features

- Output voltage initial accuracy 0.1%
- Low temperature coefficient 75 ppm/ $^{\circ}\text{C}$
- Low Supply Current, 60 μA
- Enable pin allowing a 3 μA shutdown mode
- Up to 20 mA output current
- Voltage options 1.8V, 2.048V, 2.5V, 3.0V, 3.3V, 4.096V
- Custom voltage options available (1.8V to 4.096V)
- V_{IN} range of $V_{\text{REF}} + 400 \text{ mV}$ to 5.5V @ 10 mA
- Stable with low ESR ceramic capacitors
- SOT23-5 Package
- -40°C to 125°C junction temperature range
- LM4128AQ/BQ/CQ/DQ are AEC-Q100 Grade 1 qualified and are manufactured on an Automotive Grade Flow

Applications

- Instrumentation & Process Control
- Test Equipment
- Data Acquisition Systems
- Base Stations
- Servo Systems
- Portable, Battery Powered Equipment
- Automotive & Industrial Electronics
- Precision Regulators
- Battery Chargers
- Communications
- Medical Equipment

Typical Application Circuit

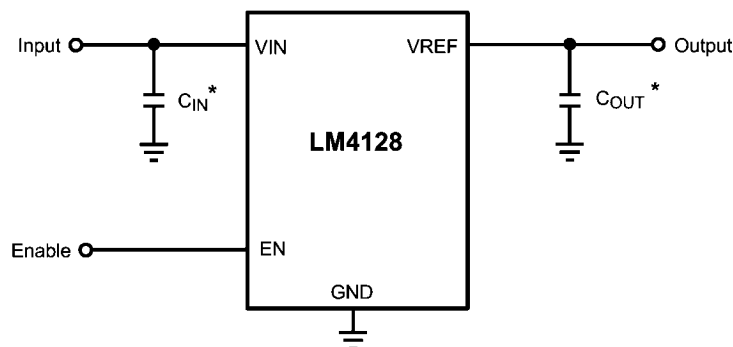

*Note: The capacitor C_{IN} is required and the capacitor C_{OUT} is optional.

20211001

Connection Diagram

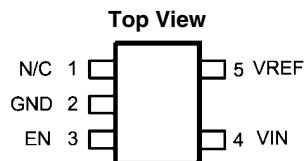

20211002
SOT23-5 Package
NS Package Number MF05A

Ordering Information

Input Output Voltage Accuracy at 25°C And Temperature Coefficient	LM4128 Supplied as 1000 units, Tape and Reel	LM4128 Supplied as 3000 units, Tape and Reel	Part Marking	Feature
0.1%, 75 ppm/°C (A grade)	LM4128AMF-1.8	LM4128AMFX-1.8	R5AA	
	LM4128AMF-2.0	LM4128AMFX-2.0	R5BA	
	LM4128AMF-2.5	LM4128AMFX-2.5	R5CA	
	LM4128AMF-3.0	LM4128AMFX-3.0	R5DA	
	LM4128AMF-3.3	LM4128AMFX-3.3	R5EA	
	LM4128AMF-4.1	LM4128AMFX-4.1	R5FA	
0.2%, 75 ppm/°C (B grade)	LM4128BMF-1.8	LM4128BMFX-1.8	R5AB	
	LM4128BMF-2.0	LM4128BMFX-2.0	R5BB	
	LM4128BMF-2.5	LM4128BMFX-2.5	R5CB	
	LM4128BMF-3.0	LM4128BMFX-3.0	R5DB	
	LM4128BMF-3.3	LM4128BMFX-3.3	R5EB	
	LM4128BMF-4.1	LM4128BMFX-4.1	R5FB	
0.5%, 100 ppm/°C (C grade)	LM4128CMF-1.8	LM4128CMFX-1.8	R5AC	
	LM4128CMF-2.0	LM4128CMFX-2.0	R5BC	
	LM4128CMF-2.5	LM4128CMFX-2.5	R5CC	
	LM4128CMF-3.0	LM4128CMFX-3.0	R5DC	
	LM4128CMF-3.3	LM4128CMFX-3.3	R5EC	
	LM4128CMF-4.1	LM4128CMFX-4.1	R5FC	
1.0%, 100 ppm/°C max (D grade)	LM4128DMF-1.8	LM4128DMFX-1.8	R5AD	
	LM4128DMF-2.0	LM4128DMFX-2.0	R5BD	
	LM4128DMF-2.5	LM4128DMFX-2.5	R5CD	
	LM4128DMF-3.0	LM4128DMFX-3.0	R5DD	
	LM4128DMF-3.3	LM4128DMFX-3.3	R5ED	
	LM4128DMF-4.1	LM4128DMFX-4.1	R5FD	

Input Output Voltage Accuracy at 25°C And Temperature Coefficient	LM4128 Supplied as 1000 units, Tape and Reel	LM4128 Supplied as 3000 units, Tape and Reel	Part Marking	Feature
0.1%, 75 ppm/°C (AQ grade)	LM4128AQ1MF1.8	LM4128AQ1MFX1.8	R6AA	AEC-Q100 Grade 1 qualified. Automotive Grade Production Flow*
	LM4128AQ1MF2.0	LM4128AQ1MFX2.0	R6BA	
	LM4128AQ1MF2.5	LM4128AQ1MFX2.5	R6CA	
	LM4128AQ1MF3.0	LM4128AQ1MFX3.0	R6DA	
	LM4128AQ1MF3.3	LM4128AQ1MFX3.3	R6EA	
	LM4128AQ1MF4.1	LM4128AQ1MFX4.1	R6FA	
0.2%, 75 ppm/°C (BQ grade)	LM4128BQ1MF1.8	LM4128BQ1MFX1.8	R6AB	AEC-Q100 Grade 1 qualified. Automotive Grade Production Flow*
	LM4128BQ1MF2.0	LM4128BQ1MFX2.0	R6BB	
	LM4128BQ1MF2.5	LM4128BQ1MFX2.5	R6CB	
	LM4128BQ1MF3.0	LM4128BQ1MFX3.0	R6DB	
	LM4128BQ1MF3.3	LM4128BQ1MFX3.3	R6EB	
	LM4128BQ1MF4.1	LM4128BQ1MFX4.1	R6FB	
0.5%, 100 ppm/°C (CQ grade)	LM4128CQ1MF1.8	LM4128CQ1MFX1.8	R6AC	AEC-Q100 Grade 1 qualified. Automotive Grade Production Flow*
	LM4128CQ1MF2.0	LM4128CQ1MFX2.0	R6BC	
	LM4128CQ1MF2.5	LM4128CQ1MFX2.5	R6CC	
	LM4128CQ1MF3.0	LM4128CQ1MFX3.0	R6DC	
	LM4128CQ1MF3.3	LM4128CQ1MFX3.3	R6EC	
	LM4128CQ1MF4.1	LM4128CQ1MFX4.1	R6FC	
1.0%, 100 ppm/°C max (DQ grade)	LM4128DQ1MF1.8	LM4128DQ1MFX1.8	R6AD	AEC-Q100 Grade 1 qualified. Automotive Grade Production Flow*
	LM4128DQ1MF2.0	LM4128DQ1MFX2.0	R6BD	
	LM4128DQ1MF2.5	LM4128DQ1MFX2.5	R6CD	
	LM4128DQ1MF3.0	LM4128DQ1MFX3.0	R6DD	
	LM4128DQ1MF3.3	LM4128DQ1MFX3.3	R6ED	
	LM4128DQ1MF4.1	LM4128DQ1MFX4.1	R6FD	

*Automotive Grade (Q) product incorporates enhanced manufacturing and support processes for the automotive market, including defect detection methodologies. Reliability qualification is compliant with the requirements and temperature grades defined in the AEC-Q100 standard. Automotive grade products are identified with the letter Q. For more information go to <http://www.national.com/automotive>.

Pin Descriptions

Pin #	Name	Function
1	N/C	No connect pin, leave floating
2	GND	Ground
3	EN	Enable pin
4	VIN	Input supply
5	VREF	Reference output

Absolute Maximum Ratings (Note 1)

If Military/Aerospace specified devices are required, please contact the National Semiconductor Sales Office/Distributors for availability and specifications.

Maximum Voltage on any input	-0.3 to 6V
Output short circuit duration	Indefinite
Power Dissipation ($T_A = 25^\circ\text{C}$) (Note 2)	350 mW
Storage Temperature Range	-65°C to 150°C
Lead Temperature (soldering, 10sec)	260°C

Vapor Phase (60 sec)	215°C
Infrared (15sec)	220°C
ESD Susceptibility (Note 3)	
Human Body Model	2 kV

Operating Ratings

Maximum Input Supply Voltage	5.5V
Maximum Enable Input Voltage	V_{IN}
Maximum Load Current	20mA
Junction Temperature Range (T_J)	-40°C to $+125^\circ\text{C}$

Electrical Characteristics

LM4128-1.8 ($V_{OUT} = 1.8\text{V}$) Limits in standard type are for $T_J = 25^\circ\text{C}$ only, and limits in **boldface type** apply over the junction temperature (T_J) range of -40°C to $+125^\circ\text{C}$ unless otherwise specified. Minimum and Maximum limits are guaranteed through test, design, or statistical correlation. Typical values represent the most likely parametric norm at $T_J = 25^\circ\text{C}$, and are provided for reference purposes only. Unless otherwise specified $V_{IN} = 5\text{V}$ and $I_{LOAD} = 0\text{A}$.

Symbol	Parameter	Conditions	Min (Note 4)	Typ (Note 5)	Max (Note 4)	Unit
V_{REF}	Output Voltage Initial Accuracy					
	LM4128A-1.8	(A Grade - 0.1%)	-0.1		+0.1	%
	LM4128B-1.8	(B Grade - 0.2%)	-0.2		+0.2	
	LM4128C-1.8	(C Grade - 0.5%)	-0.5		+0.5	
$TCV_{REF} / ^\circ\text{C}$ (Note 6)	Temperature Coefficient	LM4128A-1.8			75	ppm / $^\circ\text{C}$
		LM4128B-1.8			75	
		LM4128C-1.8			100	
		LM4128D-1.8			100	
I_Q	Supply Current			60	100	μA
I_{Q_SD}	Supply Current in Shutdown	EN = 0V		3	7	μA
$\Delta V_{REF} / \Delta V_{IN}$	Line Regulation	$V_{REF} + 400\text{ mV} \leq V_{IN} \leq 5.5\text{V}$		30		ppm / V
$\Delta V_{REF} / \Delta I_{LOAD}$	Load Regulation	$0\text{ mA} \leq I_{LOAD} \leq 20\text{ mA}$		25	120	ppm / mA
ΔV_{REF}	Long Term Stability (Note 7)	1000 Hrs		50		ppm
	Thermal Hysteresis (Note 8)	$-40^\circ\text{C} \leq T_J \leq +125^\circ\text{C}$		75		
$V_{IN} - V_{REF}$	Dropout Voltage (Note 9)	$I_{LOAD} = 10\text{ mA}$		200	400	mV
V_N	Output Noise Voltage	0.1 Hz to 10 Hz		170		μV_{PP}
I_{SC}	Short Circuit Current				75	mA
V_{IL}	Enable Pin Maximum Low Input Level				35	%V
V_{IH}	Enable Pin Minimum High Input Level		65			%V

Electrical Characteristics

LM4128-2.0 ($V_{OUT} = 2.048V$) Limits in standard type are for $T_J = 25^\circ C$ only, and limits in **boldface type** apply over the junction temperature (T_J) range of $-40^\circ C$ to $+125^\circ C$ unless otherwise specified. Minimum and Maximum limits are guaranteed through test, design, or statistical correlation. Typical values represent the most likely parametric norm at $T_J = 25^\circ C$, and are provided for reference purposes only. Unless otherwise specified $V_{IN} = 5V$ and $I_{LOAD} = 0A$.

Symbol	Parameter	Conditions	Min (Note 4)	Typ (Note 5)	Max (Note 4)	Unit
V_{REF}	Output Voltage Initial Accuracy					
	LM4128A-2.0	(A Grade - 0.1%)	-0.1		+0.1	%
	LM4128B-2.0	(B Grade - 0.2%)	-0.2		+0.2	
	LM4128C-2.0	(C Grade - 0.5%)	-0.5		+0.5	
LM4128D-2.0	(D Grade - 1.0%)	-1.0		+1.0		
$TCV_{REF} / ^\circ C$ (Note 6)	Temperature Coefficient	LM4128A-2.0			75	ppm / $^\circ C$
		LM4128B-2.0			75	
		LM4128C-2.0			100	
		LM4128D-2.0			100	
I_Q	Supply Current			60	100	μA
I_{Q_SD}	Supply Current in Shutdown	EN = 0V		3	7	μA
$\Delta V_{REF} / \Delta V_{IN}$	Line Regulation	$V_{REF} + 400\text{ mV} \leq V_{IN} \leq 5.5V$		30		ppm / V
$\Delta V_{REF} / \Delta I_{LOAD}$	Load Regulation	$0\text{ mA} \leq I_{LOAD} \leq 20\text{ mA}$		25	120	ppm / mA
ΔV_{REF}	Long Term Stability (Note 7)	1000 Hrs		50		ppm
	Thermal Hysteresis (Note 8)	$-40^\circ C \leq T_J \leq +125^\circ C$		75		
$V_{IN} - V_{REF}$	Dropout Voltage (Note 9)	$I_{LOAD} = 10\text{ mA}$		175	400	mV
V_N	Output Noise Voltage	0.1 Hz to 10 Hz		190		μV_{PP}
I_{SC}	Short Circuit Current				75	mA
V_{IL}	Enable Pin Maximum Low Input Level				35	%V
V_{IH}	Enable Pin Minimum High Input Level		65			%V

Electrical Characteristics

LM4128-2.5 ($V_{OUT} = 2.5V$) Limits in standard type are for $T_J = 25^\circ C$ only, and limits in **boldface type** apply over the junction temperature (T_J) range of $-40^\circ C$ to $+125^\circ C$ unless otherwise specified. Minimum and Maximum limits are guaranteed through test, design, or statistical correlation. Typical values represent the most likely parametric norm at $T_J = 25^\circ C$, and are provided for reference purposes only. Unless otherwise specified $V_{IN} = 5V$ and $I_{LOAD} = 0A$.

Symbol	Parameter	Conditions	Min (Note 4)	Typ (Note 5)	Max (Note 4)	Unit
V_{REF}	Output Voltage Initial Accuracy					
	LM4128A-2.5	(A Grade - 0.1%)	-0.1		+0.1	%
	LM4128B-2.5	(B Grade - 0.2%)	-0.2		+0.2	
	LM4128C-2.5	(C Grade - 0.5%)	-0.5		+0.5	
LM4128D-2.5	(D Grade - 1.0%)	-1.0		+1.0		
$TCV_{REF} / ^\circ C$ (Note 6)	Temperature Coefficient	LM4128A-2.5			75	ppm / $^\circ C$
		LM4128B-2.5			75	
		LM4128C-2.5			100	
		LM4128D-2.5			100	
I_Q	Supply Current			60	100	μA
I_{Q_SD}	Supply Current in Shutdown	EN = 0V		3	7	μA
$\Delta V_{REF} / \Delta V_{IN}$	Line Regulation	$V_{REF} + 400\text{ mV} \leq V_{IN} \leq 5.5V$		50		ppm / V
$\Delta V_{REF} / \Delta I_{LOAD}$	Load Regulation	$0\text{ mA} \leq I_{LOAD} \leq 20\text{ mA}$		25	120	ppm / mA
ΔV_{REF}	Long Term Stability (Note 7)	1000 Hrs		50		ppm
	Thermal Hysteresis (Note 8)	$-40^\circ C \leq T_J \leq +125^\circ C$		75		
$V_{IN} - V_{REF}$	Dropout Voltage (Note 9)	$I_{LOAD} = 10\text{ mA}$		175	400	mV
V_N	Output Noise Voltage	0.1 Hz to 10 Hz		275		μV_{PP}
I_{SC}	Short Circuit Current				75	mA
V_{IL}	Enable Pin Maximum Low Input Level				35	%V
V_{IH}	Enable Pin Minimum High Input Level		65			%V

Electrical Characteristics

LM4128-3.0 ($V_{OUT} = 3.0V$)

Limits in standard type are for $T_J = 25^\circ C$ only, and limits in **boldface type** apply over the junction temperature (T_J) range of $-40^\circ C$ to $+125^\circ C$ unless otherwise specified. Minimum and Maximum limits are guaranteed through test, design, or statistical correlation. Typical values represent the most likely parametric norm at $T_J = 25^\circ C$, and are provided for reference purposes only. Unless otherwise specified $V_{IN} = 5V$ and $I_{LOAD} = 0A$.

Symbol	Parameter	Conditions	Min (Note 4)	Typ (Note 5)	Max (Note 4)	Unit
V_{REF}	Output Voltage Initial Accuracy					
	LM4128A-3.0	(A Grade - 0.1%)	-0.1		+0.1	%
	LM4128B-3.0	(B Grade - 0.2%)	-0.2		+0.2	
	LM4128C-3.0	(C Grade - 0.5%)	-0.5		+0.5	
LM4128D-3.0	(D Grade - 1.0%)	-1.0		+1.0		
$TCV_{REF} / ^\circ C$ (Note 6)	Temperature Coefficient	LM4128A-3.0			75	ppm / $^\circ C$
		LM4128B-3.0			75	
		LM4128C-3.0			100	
		LM4128D-3.0			100	
I_Q	Supply Current			60	100	μA
I_{Q_SD}	Supply Current in Shutdown	EN = 0V		3	7	μA
$\Delta V_{REF} / \Delta V_{IN}$	Line Regulation	$V_{REF} + 400\text{ mV} \leq V_{IN} \leq 5.5V$		70		ppm / V
$\Delta V_{REF} / \Delta I_{LOAD}$	Load Regulation	$0\text{ mA} \leq I_{LOAD} \leq 20\text{ mA}$		25	120	ppm / mA
ΔV_{REF}	Long Term Stability (Note 7)	1000 Hrs		50		ppm
	Thermal Hysteresis (Note 8)	$-40^\circ C \leq T_J \leq +125^\circ C$		75		
$V_{IN} - V_{REF}$	Dropout Voltage (Note 9)	$I_{LOAD} = 10\text{ mA}$		175	400	mV
V_N	Output Noise Voltage	0.1 Hz to 10 Hz		285		μV_{PP}
I_{SC}	Short Circuit Current				75	mA
V_{IL}	Enable Pin Maximum Low Input Level				35	%V
V_{IH}	Enable Pin Minimum High Input Level		65			%V

Electrical Characteristics

LM4128-3.3 ($V_{OUT} = 3.3V$) Limits in standard type are for $T_J = 25^\circ C$ only, and limits in **boldface type** apply over the junction temperature (T_J) range of $-40^\circ C$ to $+125^\circ C$ unless otherwise specified. Minimum and Maximum limits are guaranteed through test, design, or statistical correlation. Typical values represent the most likely parametric norm at $T_J = 25^\circ C$, and are provided for reference purposes only. Unless otherwise specified $V_{IN} = 5V$ and $I_{LOAD} = 0A$.

Symbol	Parameter	Conditions	Min (Note 4)	Typ (Note 5)	Max (Note 4)	Unit
V_{REF}	Output Voltage Initial Accuracy					
	LM4128A-3.3	(A Grade - 0.1%)	-0.1		+0.1	%
	LM4128B-3.3	(B Grade - 0.2%)	-0.2		+0.2	
	LM4128C-3.3	(C Grade - 0.5%)	-0.5		+0.5	
LM4128D-3.3	(D Grade - 1.0%)	-1.0		+1.0		
$TCV_{REF} / ^\circ C$ (Note 6)	Temperature Coefficient	LM4128A-3.3			75	ppm / $^\circ C$
		LM4128B-3.3			75	
		LM4128C-3.3			100	
		LM4128D-3.3			100	
I_Q	Supply Current			60	100	μA
I_{Q_SD}	Supply Current in Shutdown	EN = 0V		3	7	μA
$\Delta V_{REF} / \Delta V_{IN}$	Line Regulation	$V_{REF} + 400\text{ mV} \leq V_{IN} \leq 5.5V$		85		ppm / V
$\Delta V_{REF} / \Delta I_{LOAD}$	Load Regulation	$0\text{ mA} \leq I_{LOAD} \leq 20\text{ mA}$		25	120	ppm / mA
ΔV_{REF}	Long Term Stability (Note 7)	1000 Hrs		50		ppm
	Thermal Hysteresis (Note 8)	$-40^\circ C \leq T_J \leq +125^\circ C$		75		
$V_{IN} - V_{REF}$	Dropout Voltage (Note 9)	$I_{LOAD} = 10\text{ mA}$		175	400	mV
V_N	Output Noise Voltage	0.1 Hz to 10 Hz		310		μV_{PP}
I_{SC}	Short Circuit Current				75	mA
V_{IL}	Enable Pin Maximum Low Input Level				35	%V
V_{IH}	Enable Pin Minimum High Input Level		65			%V

Electrical Characteristics

LM4128-4.1 ($V_{OUT} = 4.096V$)

Limits in standard type are for $T_J = 25^\circ C$ only, and limits in **boldface type** apply over the junction temperature (T_J) range of $-40^\circ C$ to $+125^\circ C$ unless otherwise specified. Minimum and Maximum limits are guaranteed through test, design, or statistical correlation. Typical values represent the most likely parametric norm at $T_J = 25^\circ C$, and are provided for reference purposes only. Unless otherwise specified $V_{IN} = 5V$ and $I_{LOAD} = 0A$.

Symbol	Parameter	Conditions	Min (Note 4)	Typ (Note 5)	Max (Note 4)	Unit
V_{REF}	Output Voltage Initial Accuracy					
	LM4128A-4.1	(A Grade - 0.1%)	-0.1		+0.1	%
	LM4128B-4.1	(B Grade - 0.2%)	-0.2		+0.2	
	LM4128C-4.1	(C Grade - 0.5%)	-0.5		+0.5	
LM4128D-4.1	(D Grade - 1.0%)	-1.0		+1.0		
$TCV_{REF} / ^\circ C$ (Note 6)	Temperature Coefficient	LM4128A-4.1			75	ppm / $^\circ C$
		LM4128B-4.1			75	
		LM4128C-4.1			100	
		LM4128D-4.1			100	
I_Q	Supply Current			60	100	μA
I_{Q_SD}	Supply Current in Shutdown	EN = 0V		3	7	μA
$\Delta V_{REF} / \Delta V_{IN}$	Line Regulation	$V_{REF} + 400\text{ mV} \leq V_{IN} \leq 5.5V$		100		ppm / V
$\Delta V_{REF} / \Delta I_{LOAD}$	Load Regulation	$0\text{ mA} \leq I_{LOAD} \leq 20\text{ mA}$		25	120	ppm / mA
ΔV_{REF}	Long Term Stability (Note 7)	1000 Hrs		50		ppm
	Thermal Hysteresis (Note 8)	$-40^\circ C \leq T_J \leq +125^\circ C$		75		
$V_{IN} - V_{REF}$	Dropout Voltage (Note 9)	$I_{LOAD} = 10\text{ mA}$		175	400	mV
V_N	Output Noise Voltage	0.1 Hz to 10 Hz		350		μV_{PP}
I_{SC}	Short Circuit Current				75	mA
V_{IL}	Enable Pin Maximum Low Input Level				35	%V
V_{IH}	Enable Pin Minimum High Input Level		65			%V

Note 1: Absolute Maximum Ratings indicate limits beyond which damage may occur to the device. Operating Ratings indicate conditions for which the device is intended to be functional, but do not guarantee specific performance limits. For guaranteed specifications, see Electrical Characteristics.

Note 2: Without PCB copper enhancements. The maximum power dissipation must be de-rated at elevated temperatures and is limited by T_{JMAX} (maximum junction temperature), θ_{J-A} (junction to ambient thermal resistance) and T_A (ambient temperature). The maximum power dissipation at any temperature is: $P_{DISSMAX} = (T_{JMAX} - T_A) / \theta_{J-A}$ up to the value listed in the Absolute Maximum Ratings. θ_{J-A} for SOT23-5 package is $220^\circ C/W$, $T_{JMAX} = 125^\circ C$.

Note 3: The human body model is a 100 pF capacitor discharged through a 1.5 k Ω resistor into each pin.

Note 4: Limits are 100% production tested at $25^\circ C$. Limits over the operating temperature range are guaranteed through correlation using Statistical Quality Control.

Note 5: Typical numbers are at $25^\circ C$ and represent the most likely parametric norm.

Note 6: Temperature coefficient is measured by the "Box" method; i.e., the maximum ΔV_{REF} is divided by the maximum ΔT .

Note 7: Long term stability is V_{REF} @ $25^\circ C$ measured during 1000 hrs.

Note 8: Thermal hysteresis is defined as the change in $+25^\circ C$ output voltage before and after cycling the device from $(-40^\circ C$ to $125^\circ C)$.

Note 9: Dropout voltage is defined as the minimum input to output differential at which the output voltage drops by 0.5% below the value measured with a 5V input.

Typical Performance Characteristics for 2.5V

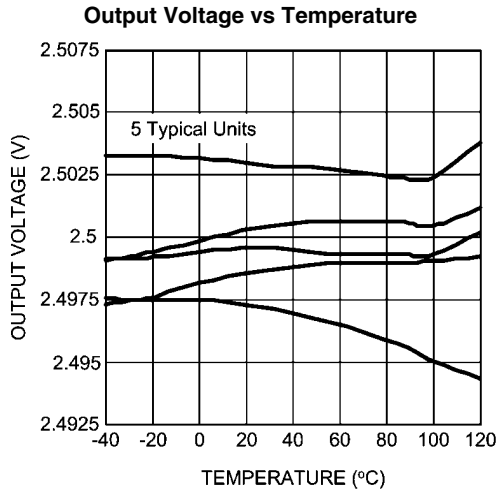

20211054

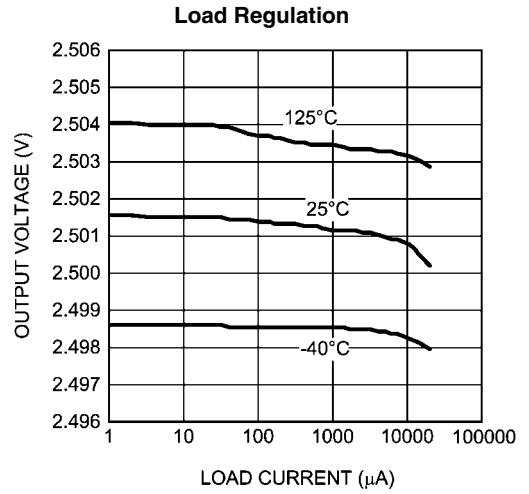

20211055

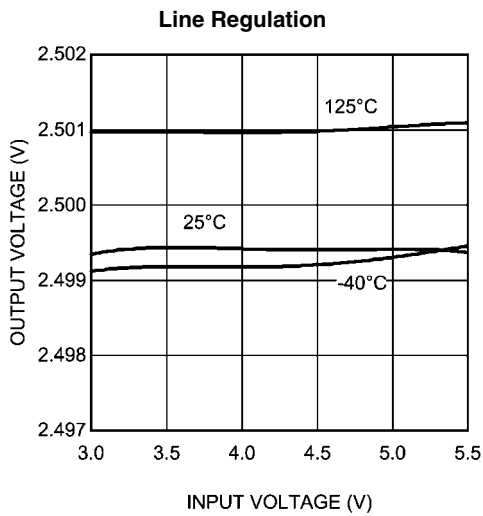

20211056

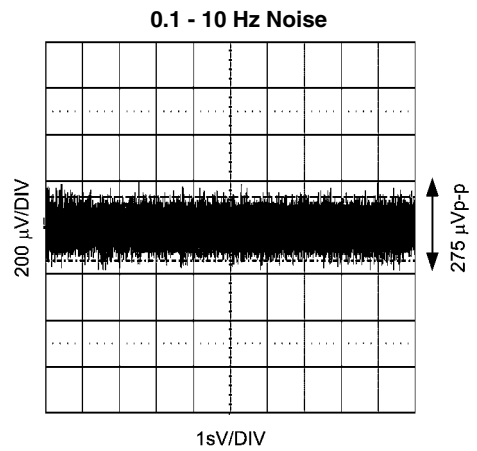

20211021

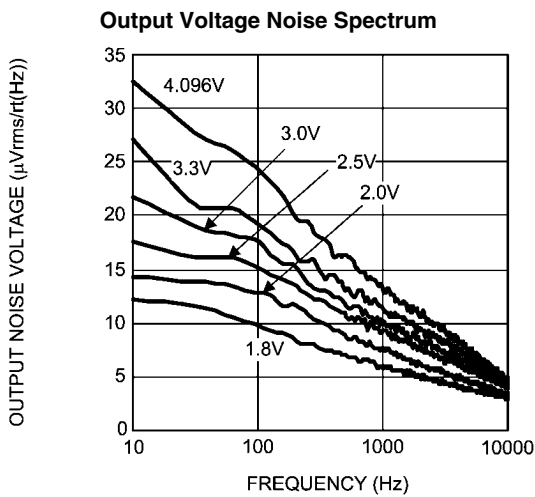

20211057

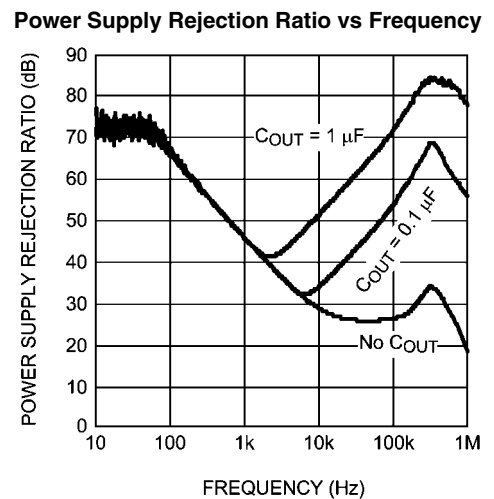

20211058

Dropout vs Load to 0.5% Accuracy

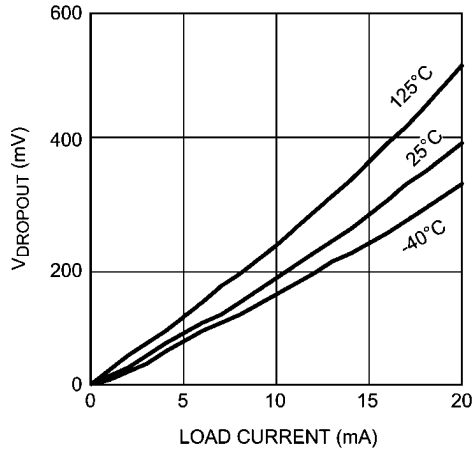

20211008

Typical Long Term Stability

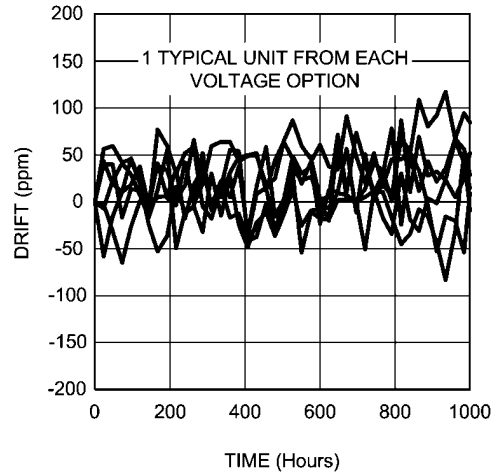

20211030

Supply Current vs Input Voltage

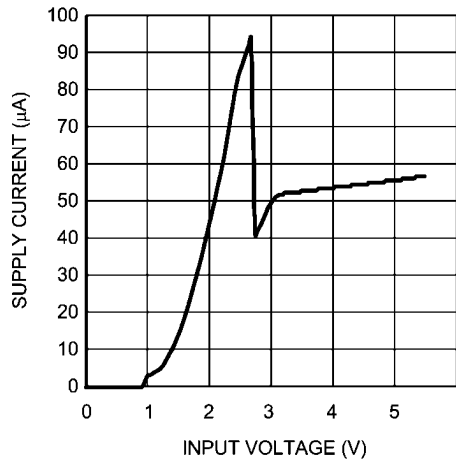

20211053

Shutdown I_Q vs Input Voltage

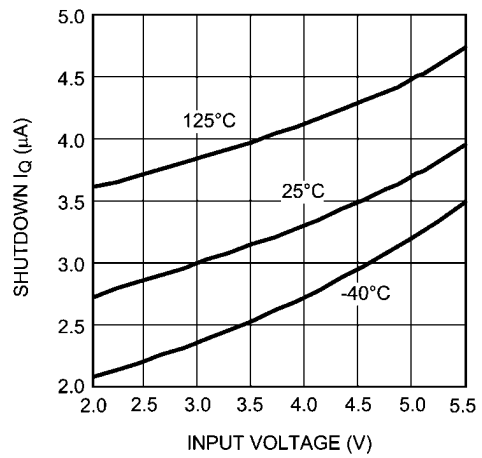

20211010

Ground Current vs Load Current

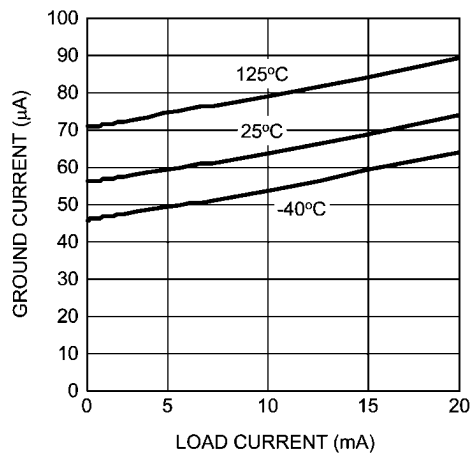

20211018

**Line Transient Response
 $V_{IN} = 3V$ to $5V$**

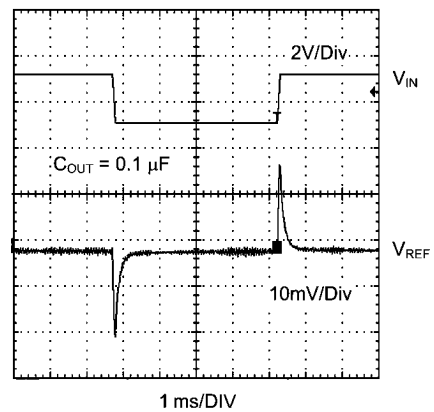

20211051

Load Transient Response
 $I_{LOAD} = 0 \text{ to } 10\text{mA}$

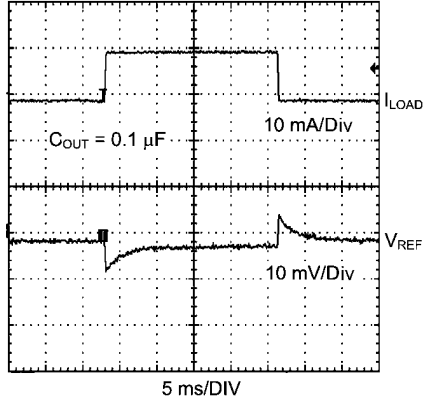

20211050

Short-Circuit Protection and Recovery

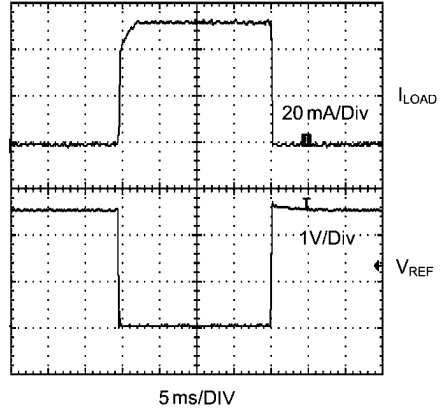

20211082

Start-Up Response

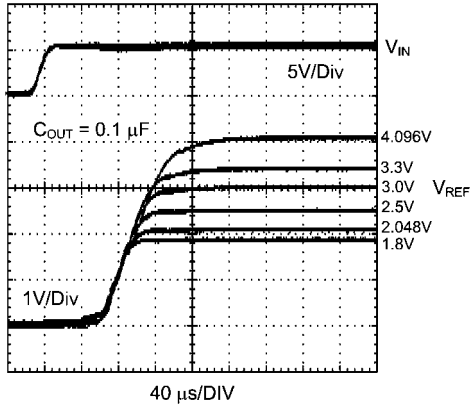

20211083

Application Information

THEORY OF OPERATION

The foundation of any voltage reference is the band-gap circuit. While the reference in the LM4128 is developed from the gate-source voltage of transistors in the IC, principles of the band-gap circuit are easily understood using a bipolar example. For a detailed analysis of the bipolar band-gap circuit, please refer to Application Note AN-56.

SUPPLY AND ENABLE VOLTAGES

To ensure proper operation, V_{EN} and V_{IN} must be within a specified range. An acceptable range of input voltages is

$$V_{IN} > V_{REF} + 400 \text{ mV} \quad (I_{LOAD} \leq 10 \text{ mA})$$

The enable pin uses an internal pull-up current source ($I_{PULL_UP} \approx 2 \mu\text{A}$) that may be left floating or triggered by an external source. If the part is not enabled by an external source, it may be connected to V_{IN} . An acceptable range of enable voltages is given by the enable transfer characteristics. See the Electrical Characteristics section and Enable Transfer Characteristics figure for more detail. Note, the part will not operate correctly for $V_{EN} > V_{IN}$.

COMPONENT SELECTION

A small ceramic (X5R or X7R) capacitor on the input must be used to ensure stable operation. The value of C_{IN} must be sized according to the output capacitor value. The value of C_{IN} must satisfy the relationship $C_{IN} \geq C_{OUT}$. When no output capacitor is used, C_{IN} must have a minimum value of 0.1 μF . Noise on the power-supply input may affect the output noise. Larger input capacitor values (typically 4.7 μF to 22 μF) may help reduce noise on the output and significantly reduce overshoot during startup. Use of an additional optional bypass capacitor between the input and ground may help further reduce noise on the output. With an input capacitor, the LM4128 will drive any combination of resistance and capacitance up to $V_{REF}/20 \text{ mA}$ and 10 μF respectively.

The LM4128 is designed to operate with or without an output capacitor and is stable with capacitive loads up to 10 μF . Connecting a capacitor between the output and ground will significantly improve the load transient response when switching from a light load to a heavy load. The output capacitor should not be made arbitrarily large because it will effect the turn-on time as well as line and load transients.

While a variety of capacitor chemistry types may be used, it is typically advisable to use low esr ceramic capacitors. Such capacitors provide a low impedance to high frequency signals, effectively bypassing them to ground. Bypass capacitors should be mounted close to the part. Mounting bypass capacitors close to the part will help reduce the parasitic trace components thereby improving performance.

SHORT CIRCUITED OUTPUT

The LM4128 features indefinite short circuit protection. This protection limits the output current to 75 mA when the output is shorted to ground.

TURN ON TIME

Turn on time is defined as the time taken for the output voltage to rise to 90% of the preset value. The turn on time depends on the load. The turn on time is typically 33.2 μs when driving a 1 μF load and 78.8 μs when driving a 10 μF load. Some users may experience an extended turn on time (up to 10 ms) under brown out conditions and low temperatures (-40°C).

THERMAL HYSTERESIS

Thermal hysteresis is defined as the change in output voltage at 25°C after some deviation from 25°C. This is to say that thermal hysteresis is the difference in output voltage between two points in a given temperature profile. An illustrative temperature profile is shown in *Figure 1*.

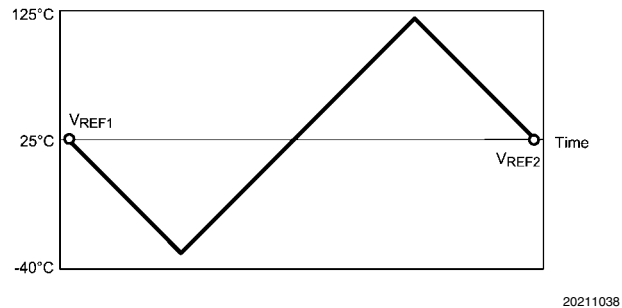

FIGURE 1. Illustrative Temperature Profile

This may be expressed analytically as the following:

$$V_{HYS} = \frac{|V_{REF1} - V_{REF2}|}{V_{REF}} \times 10^3 \text{ mV}$$

Where

V_{HYS} = Thermal hysteresis expressed in ppm

V_{REF} = Nominal preset output voltage

$V_{REF1} = V_{REF}$ before temperature fluctuation

$V_{REF2} = V_{REF}$ after temperature fluctuation.

The LM4128 features a low thermal hysteresis of 190 μV from -40°C to 125°C.

TEMPERATURE COEFFICIENT

Temperature drift is defined as the maximum deviation in output voltage over the operating temperature range. This deviation over temperature may be illustrated as shown in *Figure 2*.

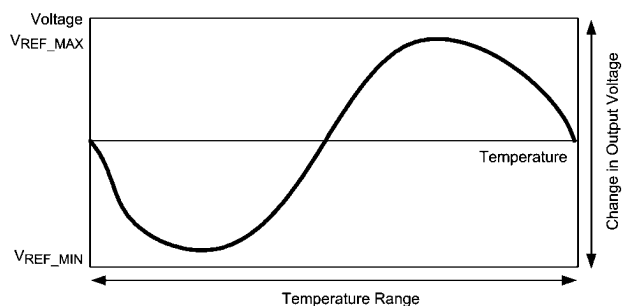

FIGURE 2. Illustrative Temperature Coefficient Profile

Temperature coefficient may be expressed analytically as the following:

$$T_D = \frac{(V_{REF_MAX} - V_{REF_MIN})}{V_{REF} \times \Delta T} \times 10^6 \text{ ppm}$$

T_D = Temperature drift

V_{REF} = Nominal preset output voltage

V_{REF_MIN} = Minimum output voltage over operating temperature range

V_{REF_MAX} = Maximum output voltage over operating temperature range

ΔT = Operating temperature range.

The LM4128 features a low temperature drift of 75 ppm (max) to 100 ppm (max), depending on the grade, from -40°C to 125°C.

LONG TERM STABILITY

Long-term stability refers to the fluctuation in output voltage over a long period of time (1000 hours). The LM4128 features a typical long-term stability of 50 ppm over 1000 hours. The measurements are made using 5 units of each voltage option, at a nominal input voltage (5V), with no load, at room temperature.

EXPRESSION OF ELECTRICAL CHARACTERISTICS

Electrical characteristics are typically expressed in mV, ppm, or a percentage of the nominal value. Depending on the application, one expression may be more useful than the other. To convert one quantity to the other one may apply the following:

ppm to mV error in output voltage:

$$\frac{V_{REF} \times \text{ppm}_{ERROR}}{10^3} = V_{ERROR}$$

Where:

V_{REF} is in volts (V) and V_{ERROR} is in milli-volts (mV).

Bit error (1 bit) to voltage error (mV):

$$\frac{V_{REF}}{2^n} \times 10^3 = V_{ERROR}$$

V_{REF} is in volts (V), V_{ERROR} is in milli-volts (mV), and n is the number of bits.

mV to ppm error in output voltage:

$$\frac{V_{ERROR}}{V_{REF}} \times 10^3 = \text{ppm}_{ERROR}$$

Where:

V_{REF} is in volts (V) and V_{ERROR} is in milli-volts (mV).

Voltage error (mV) to percentage error (percent):

$$\frac{V_{ERROR}}{V_{REF}} \times 0.1 = \text{Percent_Error}$$

Where:

V_{REF} is in volts (V) and V_{ERROR} is in milli-volts (mV).

PRINTED CIRCUIT BOARD and LAYOUT CONSIDERATIONS

References in SOT packages are generally less prone to PC board mounting than devices in Small Outline (SOIC) packages. To minimize the mechanical stress due to PC board mounting that can cause the output voltage to shift from its initial value, mount the reference on a low flex area of the PC board, such as near the edge or a corner.

The part may be isolated mechanically by cutting a U shape slot on the PCB for mounting the device. This approach also provides some thermal isolation from the rest of the circuit.

Bypass capacitors must be mounted close to the part. Mounting bypass capacitors close to the part will reduce the parasitic trace components thereby improving performance.

Typical Application Circuits

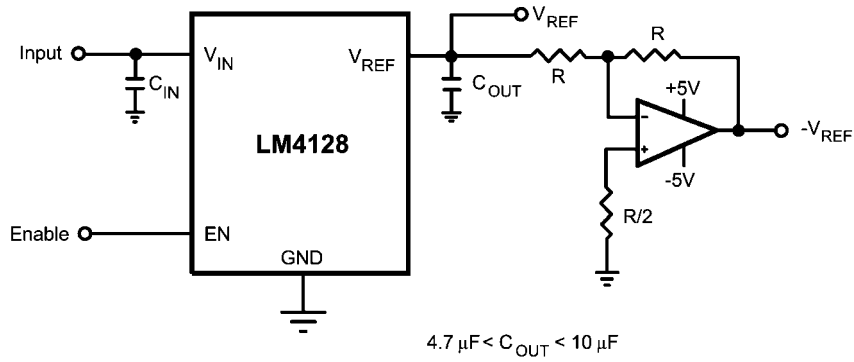

20211026

FIGURE 3. Voltage Reference with Complimentary Output

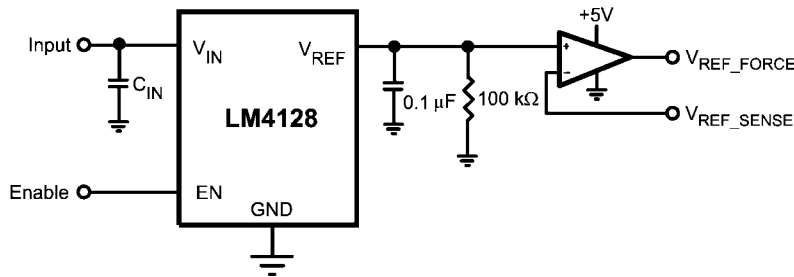

20211027

FIGURE 4. Precision Voltage Reference with Force and Sense Output

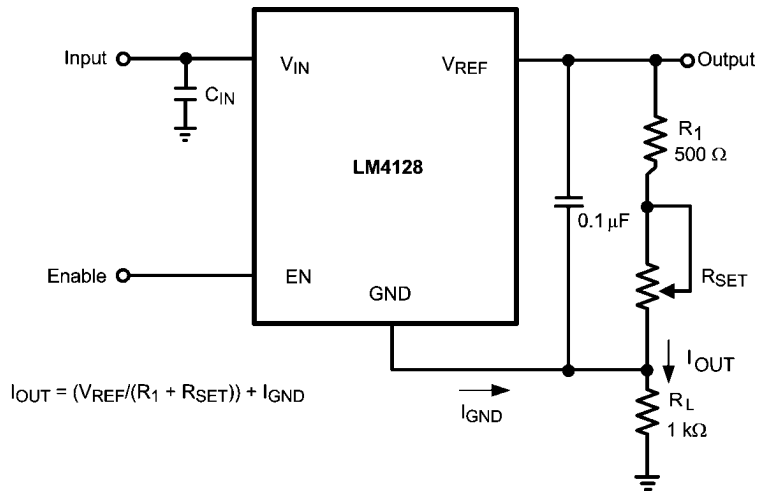

20211028

FIGURE 5. Programmable Current Source

Physical Dimensions inches (millimeters) unless otherwise noted

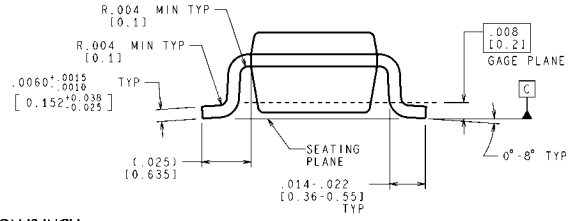
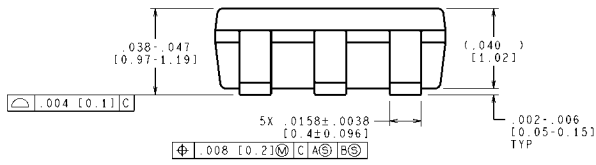
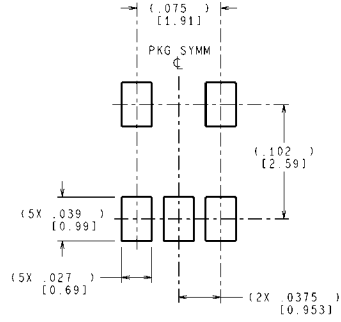
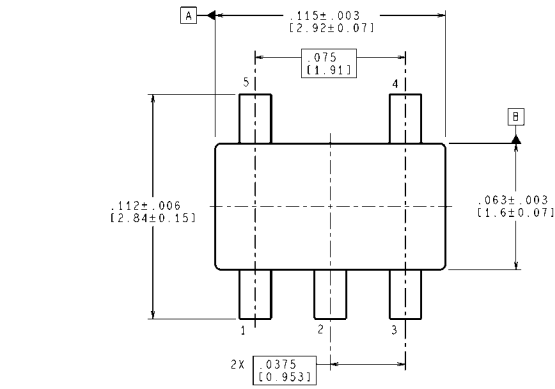

CONTROLLING DIMENSION IS INCH
 VALUES IN [] ARE MILLIMETERS
 DIMENSIONS IN () FOR REFERENCE ONLY

SOT23-5 Package
NS Package Number MF05A

MF05A (Rev D)

Notes

Notes

For more National Semiconductor product information and proven design tools, visit the following Web sites at:

Products		Design Support	
Amplifiers	www.national.com/amplifiers	WEBENCH	www.national.com/webench
Audio	www.national.com/audio	Analog University	www.national.com/AU
Clock Conditioners	www.national.com/timing	App Notes	www.national.com/appnotes
Data Converters	www.national.com/adc	Distributors	www.national.com/contacts
Displays	www.national.com/displays	Green Compliance	www.national.com/quality/green
Ethernet	www.national.com/ethernet	Packaging	www.national.com/packaging
Interface	www.national.com/interface	Quality and Reliability	www.national.com/quality
LVDS	www.national.com/lvds	Reference Designs	www.national.com/refdesigns
Power Management	www.national.com/power	Feedback	www.national.com/feedback
Switching Regulators	www.national.com/switchers		
LDOs	www.national.com/ldo		
LED Lighting	www.national.com/led		
PowerWise	www.national.com/powerwise		
Serial Digital Interface (SDI)	www.national.com/sdi		
Temperature Sensors	www.national.com/tempsensors		
Wireless (PLL/VCO)	www.national.com/wireless		

THE CONTENTS OF THIS DOCUMENT ARE PROVIDED IN CONNECTION WITH NATIONAL SEMICONDUCTOR CORPORATION ("NATIONAL") PRODUCTS. NATIONAL MAKES NO REPRESENTATIONS OR WARRANTIES WITH RESPECT TO THE ACCURACY OR COMPLETENESS OF THE CONTENTS OF THIS PUBLICATION AND RESERVES THE RIGHT TO MAKE CHANGES TO SPECIFICATIONS AND PRODUCT DESCRIPTIONS AT ANY TIME WITHOUT NOTICE. NO LICENSE, WHETHER EXPRESS, IMPLIED, ARISING BY ESTOPPEL OR OTHERWISE, TO ANY INTELLECTUAL PROPERTY RIGHTS IS GRANTED BY THIS DOCUMENT.

TESTING AND OTHER QUALITY CONTROLS ARE USED TO THE EXTENT NATIONAL DEEMS NECESSARY TO SUPPORT NATIONAL'S PRODUCT WARRANTY. EXCEPT WHERE MANDATED BY GOVERNMENT REQUIREMENTS, TESTING OF ALL PARAMETERS OF EACH PRODUCT IS NOT NECESSARILY PERFORMED. NATIONAL ASSUMES NO LIABILITY FOR APPLICATIONS ASSISTANCE OR BUYER PRODUCT DESIGN. BUYERS ARE RESPONSIBLE FOR THEIR PRODUCTS AND APPLICATIONS USING NATIONAL COMPONENTS. PRIOR TO USING OR DISTRIBUTING ANY PRODUCTS THAT INCLUDE NATIONAL COMPONENTS, BUYERS SHOULD PROVIDE ADEQUATE DESIGN, TESTING AND OPERATING SAFEGUARDS.

EXCEPT AS PROVIDED IN NATIONAL'S TERMS AND CONDITIONS OF SALE FOR SUCH PRODUCTS, NATIONAL ASSUMES NO LIABILITY WHATSOEVER, AND NATIONAL DISCLAIMS ANY EXPRESS OR IMPLIED WARRANTY RELATING TO THE SALE AND/OR USE OF NATIONAL PRODUCTS INCLUDING LIABILITY OR WARRANTIES RELATING TO FITNESS FOR A PARTICULAR PURPOSE, MERCHANTABILITY, OR INFRINGEMENT OF ANY PATENT, COPYRIGHT OR OTHER INTELLECTUAL PROPERTY RIGHT.

LIFE SUPPORT POLICY

NATIONAL'S PRODUCTS ARE NOT AUTHORIZED FOR USE AS CRITICAL COMPONENTS IN LIFE SUPPORT DEVICES OR SYSTEMS WITHOUT THE EXPRESS PRIOR WRITTEN APPROVAL OF THE CHIEF EXECUTIVE OFFICER AND GENERAL COUNSEL OF NATIONAL SEMICONDUCTOR CORPORATION. As used herein:

Life support devices or systems are devices which (a) are intended for surgical implant into the body, or (b) support or sustain life and whose failure to perform when properly used in accordance with instructions for use provided in the labeling can be reasonably expected to result in a significant injury to the user. A critical component is any component in a life support device or system whose failure to perform can be reasonably expected to cause the failure of the life support device or system or to affect its safety or effectiveness.

National Semiconductor and the National Semiconductor logo are registered trademarks of National Semiconductor Corporation. All other brand or product names may be trademarks or registered trademarks of their respective holders.

Copyright© 2008 National Semiconductor Corporation

For the most current product information visit us at www.national.com



National Semiconductor Americas Technical Support Center
Email: support@nsc.com
Tel: 1-800-272-9959

National Semiconductor Europe Technical Support Center
Email: europe.support@nsc.com
German Tel: +49 (0) 180 5010 771
English Tel: +44 (0) 870 850 4288

National Semiconductor Asia Pacific Technical Support Center
Email: ap.support@nsc.com

National Semiconductor Japan Technical Support Center
Email: jpn.feedback@nsc.com

Looking for pricing, stock, or lifecycle information?

Click below to explore more details on WIN SOURCE:

-  [View LM4128AMF-3.0 on WIN SOURCE](#)
-  [Texas Instruments](#) Information

Optimize Your Supply Chain with WIN SOURCE Solutions

-  Global Sourcing Solution
-  Obsolete Management
-  Cost Control Management
-  Shortage Management
-  Alternative Solution
-  Excess Inventory Management