



THE DATASHEET OF LPR510AL





LPR510AL

MEMS motion sensor: dual axis pitch and roll $\pm 100^\circ/\text{s}$ analog gyroscope

Preliminary data

Features

- 2.7 V to 3.6 V single-supply operation
- Wide operating temperature range (-40 °C to +85 °C)
- High stability overtemperature
- Analog absolute angular-rate output
- Two separate outputs for each axis (1x and 4x amplified)
- Integrated low-pass filters
- Low power consumption
- Embedded power-down
- Embedded self-test
- High shock and vibration survivability
- ECOPACK[®] RoHS and “Green” compliant (see [Section 5](#))

Applications

- GPS navigation systems
- Motion tracking
- Pointing devices, remote and game controllers
- Motion control with user interface
- Industrial and robotics

Description

The LPR510AL is a low-power dual-axis micromachined gyroscope capable of measuring angular rate along pitch and roll axes.

It provides excellent temperature stability and high resolution over an extended operating temperature range (-40 °C to +85 °C).

Table 1. Device summary

Order code	Temperature range (°C)	Package	Packing
LPR510AL	-40 to +85	LGA-16 (5x5x1.5)	Tray
LPR510ALTR	-40 to +85	LGA-16 (5x5x1.5)	Tape and reel

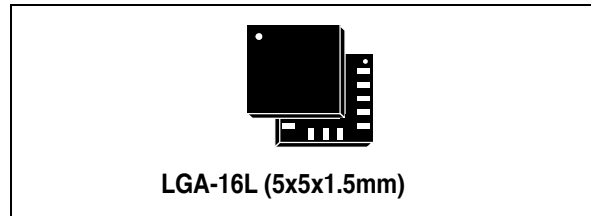

The LPR510AL has a full scale of $\pm 100^\circ/\text{s}$ and is capable of detecting rates with a -3 dB bandwidth up to 140 Hz. The gyroscope is the combination of one actuator and one accelerometer integrated in a single micromachined structure.

It includes a sensing element composed by single driving mass, kept in continuous oscillating movement and able to react when an angular rate is applied based on the Coriolis principle.

A CMOS IC provides the measured angular rate to the external world through an analog output voltage, allowing high level of integration and production trimming to better match sensing element characteristics.

ST's gyroscope family leverages on robust and mature manufacturing process already used for the production of micromachined accelerometers.

ST is already in the field with several hundreds million sensors with excellent acceptance from the market in terms of quality, reliability and performance.

LPR510AL is provided in plastic land grid array (LGA) package. Several years ago ST pioneered successfully the usage of this package for accelerometers. Today ST has the widest manufacturing capability and strongest expertise in the world for production of sensor in plastic LGA package.

Contents

- 1 Block diagram and pin description 3**
 - 1.1 Pin description 3

- 2 Mechanical and electrical specifications 5**
 - 2.1 Mechanical characteristics 5
 - 2.2 Electrical characteristics 6
 - 2.3 Absolute maximum ratings 6

- 3 Terminology 7**
 - 3.1 Sensitivity 7
 - 3.2 Zero-rate level 7
 - 3.3 Self-test 7
 - 3.4 High pass filter reset (HP) 7

- 4 Application hints 8**
 - 4.1 Output response vs. rotation 9
 - 4.2 Soldering information 9

- 5 Package information 10**

- 6 Revision history 11**

Table 2. Pin description

Pin #	Pin name	Analog function
1	GND	0V supply voltage
2	FILTVDD	PLL filter connection pin #2
3	VCONT	PLL filter connection pin #1
4	OUTY	Not amplified output
5	4xINY	Input of 4x amplifier
6	4xOUTY	Y rate signal output voltage (amplified)
7	Vref	Reference voltage
8	4xOUTX	X rate signal output voltage (amplified)
9	4xINX	Input of 4x amplifier
10	OUTX	Not amplified output
11	ST	Self-test (logic 0: normal mode; logic 1: self-test)
12	PD	Power-down (logic 0: normal mode; logic 1: power-down mode)
13	HP	High pass filter reset (logic 0: normal operation mode; logic1: external high pass filter is reset)
14,15	Res	Reserved. Connect to Vdd
16	Vdd	Power supply

2 Mechanical and electrical specifications

2.1 Mechanical characteristics

Table 3. Mechanical characteristics @ Vdd = 3 V, T = 25 °C unless otherwise noted⁽¹⁾

Symbol	Parameter	Test condition	Min.	Typ. ⁽²⁾	Max.	Unit
FSA	Measurement range	4x OUT (amplified)		±100		°/s
FS		OUT (not amplified)		±400		°/s
SoA	Sensitivity ⁽³⁾	4x OUT (amplified)		10		mV/°/s
So		OUT (not amplified)		2.5		mV/°/s
SoDr	Sensitivity change vs temperature	Delta from 25°C		0.03		%/°C
Voff	Zero-rate level ⁽³⁾			1.23		V
Vref	Reference voltage			1.23		V
OffDr	Zero-rate level change Vs temperature	Delta from 25°C		0.02		°/s/°C
NL	Non linearity	Best fit straight line		±1		% FS
BW	Bandwidth ⁽⁴⁾			140		Hz
Rn	Rate noise density			0.017		°/s / $\sqrt{\text{Hz}}$
Top	Operating temperature range		-40		+85	°C

1. The product is factory calibrated at 3 V. The operational power supply range is specified in [Table 4](#).
2. Typical specifications are not guaranteed
3. Sensitivity and zero-rate level are not ratiometric to supply voltage
4. The product is capable of measuring angular rates extending from DC to the selected BW.

2.2 Electrical characteristics

Table 4. Electrical characteristics @ Vdd =3 V, T=25 °C unless otherwise noted⁽¹⁾

Symbol	Parameter	Test condition	Min.	Typ. ⁽²⁾	Max.	Unit
Vdd	Supply voltage		2.7	3	3.6	V
Idd	Supply current	PD pin connected to GND		6.8		mA
IddPdn	Supply current in power-down mode	PD pin connected to Vdd		1	5	µA
VST	Self-test input	Logic 0 level	0		0.2*Vdd	V
		Logic 1 level	0.8*Vdd		Vdd	
VPD	Power-down input	Logic 0 level	0		0.2*Vdd	V
		Logic 1 level	0.8*Vdd		Vdd	
Top	Operating temperature range		-40		+85	°C

1. The product is factory calibrated at 3 V
2. Typical specifications are not guaranteed

2.3 Absolute maximum ratings

Stresses above those listed as “Absolute maximum ratings” may cause permanent damage to the device. This is a stress rating only and functional operation of the device under these conditions is not implied. Exposure to maximum rating conditions for extended periods may affect device reliability.

Table 5. Absolute maximum ratings

Symbol	Ratings	Maximum value	Unit
Vdd	Supply voltage	-0.3 to 6	V
Vin	Input voltage on any control pin (PD, ST)	-0.3 to Vdd +0.3	V
T _{STG}	Storage temperature range	-40 to +125	°C
A	Acceleration	3000 g for 0.5 ms	
		10000 g for 0.1 ms	
ESD	Electrostatic discharge protection	2 (HBM)	kV

 This is a mechanical shock sensitive device, improper handling can cause permanent damage to the part

 This is an ESD sensitive device, improper handling can cause permanent damage to the part

3 Terminology

3.1 Sensitivity

An angular rate gyroscope is a device that produces a positive-going output voltage for counterclockwise rotation around the sensitive axis considered. Sensitivity describes the gain of the sensor and can be determined by applying a defined angular velocity to it. This value changes very little over temperature and time.

3.2 Zero-rate level

Zero-rate level describes the actual output signal if there is no angular rate present. The zero-rate level of precise MEMS sensors is, to some extent, a result of stress to the sensor and therefore zero-rate level can slightly change after mounting the sensor onto a printed circuit board or after exposing it to extensive mechanical stress. This value changes very little over temperature and time.

3.3 Self-test

Self-test allows testing of the mechanical and electrical part of the sensor, allowing the seismic mass to be moved by means of an electrostatic test-force. The self-test function is off when the ST pin is connected to GND. When the ST pin is tied to Vdd, an actuation force is applied to the sensor, emulating a definite Coriolis force. In this case the sensor output will exhibit a voltage change in its DC level which is also dependent on the supply voltage. When ST is active, the device output level is given by the algebraic sum of the signals produced by the velocity acting on the sensor and by the electrostatic test-force. If the output signals change within the amplitude specified in [Table 3](#), then the mechanical element is working properly and the parameters of the interface chip are within the defined specifications.

3.4 High pass filter reset (HP)

The LPR510AL provides the possibility to reset the optional external high pass filter by applying a high logic value to the HP pad. This procedure ensures faster response, especially during overload conditions. Moreover, this operation is suggested each time the device is powered.

4 Application hints

Figure 3. LPR510AL electrical connections and external components values

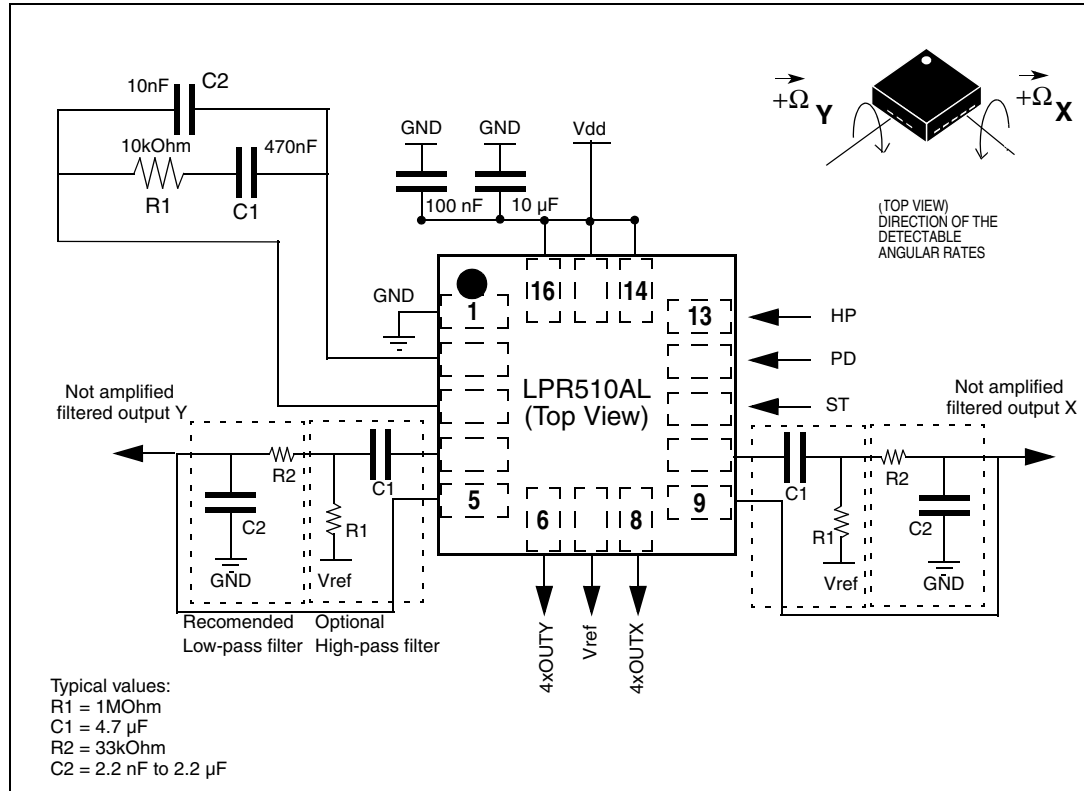

Power supply decoupling capacitors (100 nF ceramic or polyester + 10 µF aluminum) should be placed as near as possible to the device (common design practice).

The LPR510AL allows band limiting of the output rate response through the use of an external low pass filter (suggested) and/or high pass filter (optional) in addition to the embedded low pass filter ($f_t = 140$ Hz).

4xOUTX and 4xOUTY are respectively OUTX and OUTY amplified outputs lines, internally buffered to ensure low output impedance.

If external high pass or low pass filtering is not applied it is mandatory to short-circuit respectively pad 4 to pad 5 and pad 9 to pad 10 when amplified outputs are used.

When only not-amplified outputs are used (OUTX/Y), it is suggested to set pads 5 and 9 to fixed reference voltage (GND/Vref).

When high pass filter is applied to not amplified output (OUTx), it is recommended to buffer the line before entering ADC for performance optimization.

The LPR510AL IC includes a PLL (phase locked loop) circuit to synchronize driving and sensing interfaces. Capacitors and resistors must be added at the **FILTVDD** and **VCNT** pins (as shown in [Figure 3](#)) to implement a low-pass filter.

4.1 Output response vs. rotation

Figure 4. Output response vs. rotation

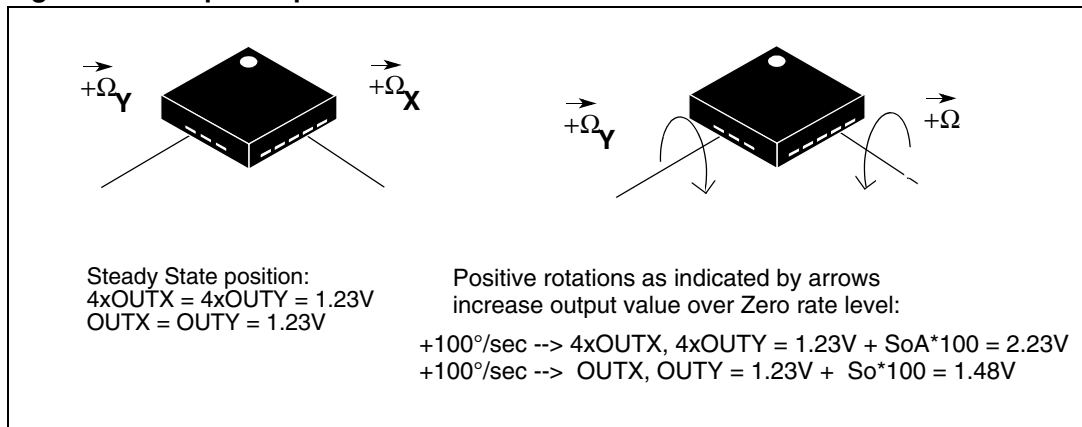

4.2 Soldering information

The LGA package is compliant with the ECOPACK[®], RoHS and “Green” standard. It is qualified for soldering heat resistance according to JEDEC J-STD-020C.

Leave “pin 1 indicator” unconnected during soldering.

Land pattern and soldering recommendations are available at www.st.com.

5 Package information

In order to meet environmental requirements, ST offers these devices in different grades of ECOPACK® packages, depending on their level of environmental compliance. ECOPACK® specifications, grade definitions and product status are available at: www.st.com. ECOPACK is an ST trademark.

Figure 5. LGA-16: mechanical data and package dimensions

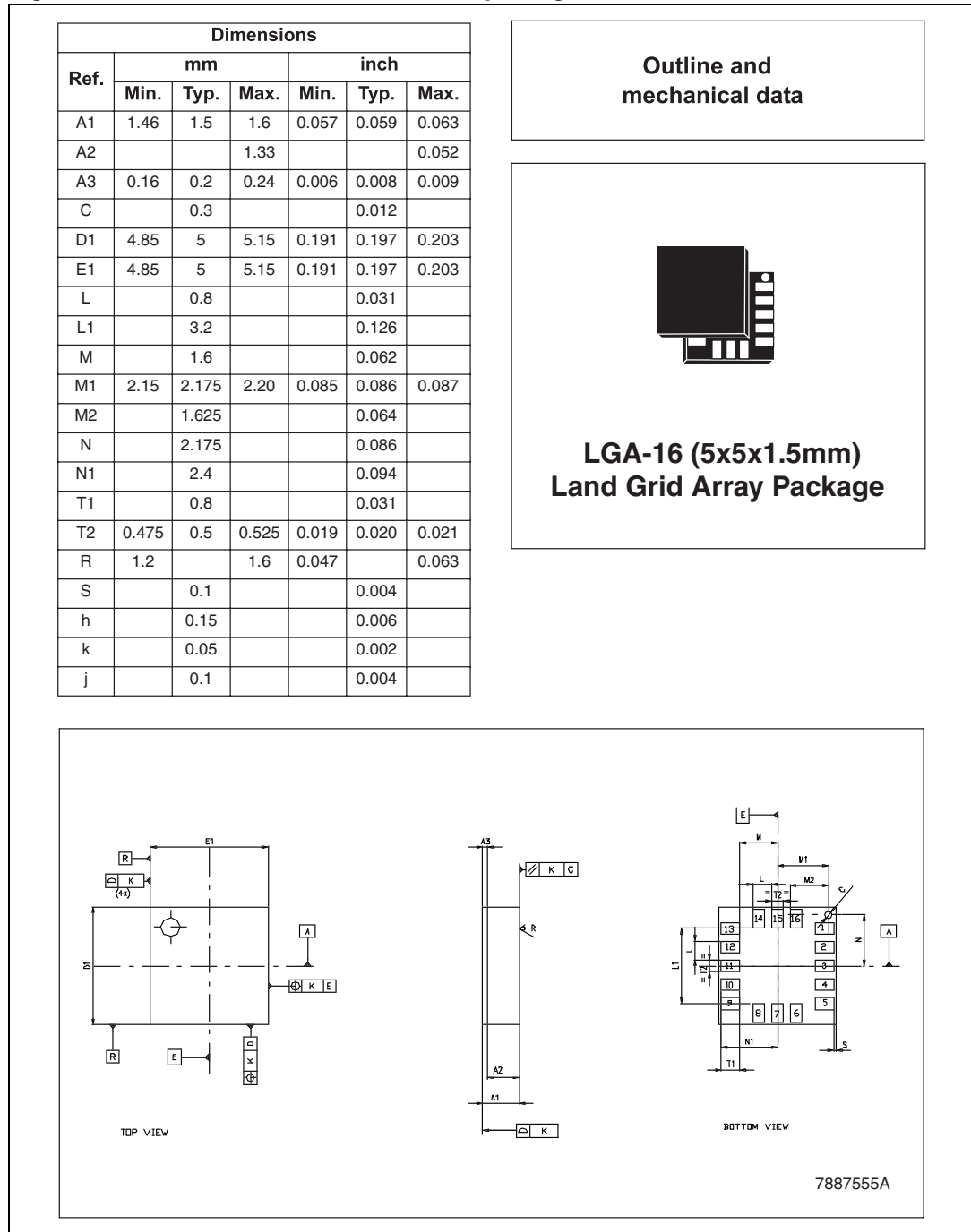

6 Revision history

Table 6. Document revision history

Date	Revision	Changes
04-Jun-2009	1	Initial release
06-Jul-2009	2	Small text changes to improve readability. Updated Table 4

Please Read Carefully:

Information in this document is provided solely in connection with ST products. STMicroelectronics NV and its subsidiaries ("ST") reserve the right to make changes, corrections, modifications or improvements, to this document, and the products and services described herein at any time, without notice.

All ST products are sold pursuant to ST's terms and conditions of sale.

Purchasers are solely responsible for the choice, selection and use of the ST products and services described herein, and ST assumes no liability whatsoever relating to the choice, selection or use of the ST products and services described herein.

No license, express or implied, by estoppel or otherwise, to any intellectual property rights is granted under this document. If any part of this document refers to any third party products or services it shall not be deemed a license grant by ST for the use of such third party products or services, or any intellectual property contained therein or considered as a warranty covering the use in any manner whatsoever of such third party products or services or any intellectual property contained therein.

UNLESS OTHERWISE SET FORTH IN ST'S TERMS AND CONDITIONS OF SALE ST DISCLAIMS ANY EXPRESS OR IMPLIED WARRANTY WITH RESPECT TO THE USE AND/OR SALE OF ST PRODUCTS INCLUDING WITHOUT LIMITATION IMPLIED WARRANTIES OF MERCHANTABILITY, FITNESS FOR A PARTICULAR PURPOSE (AND THEIR EQUIVALENTS UNDER THE LAWS OF ANY JURISDICTION), OR INFRINGEMENT OF ANY PATENT, COPYRIGHT OR OTHER INTELLECTUAL PROPERTY RIGHT.

UNLESS EXPRESSLY APPROVED IN WRITING BY AN AUTHORIZED ST REPRESENTATIVE, ST PRODUCTS ARE NOT RECOMMENDED, AUTHORIZED OR WARRANTED FOR USE IN MILITARY, AIR CRAFT, SPACE, LIFE SAVING, OR LIFE SUSTAINING APPLICATIONS, NOR IN PRODUCTS OR SYSTEMS WHERE FAILURE OR MALFUNCTION MAY RESULT IN PERSONAL INJURY, DEATH, OR SEVERE PROPERTY OR ENVIRONMENTAL DAMAGE. ST PRODUCTS WHICH ARE NOT SPECIFIED AS "AUTOMOTIVE GRADE" MAY ONLY BE USED IN AUTOMOTIVE APPLICATIONS AT USER'S OWN RISK.

Resale of ST products with provisions different from the statements and/or technical features set forth in this document shall immediately void any warranty granted by ST for the ST product or service described herein and shall not create or extend in any manner whatsoever, any liability of ST.

ST and the ST logo are trademarks or registered trademarks of ST in various countries.

Information in this document supersedes and replaces all information previously supplied.

The ST logo is a registered trademark of STMicroelectronics. All other names are the property of their respective owners.

© 2009 STMicroelectronics - All rights reserved



STMicroelectronics group of companies

Australia - Belgium - Brazil - Canada - China - Czech Republic - Finland - France - Germany - Hong Kong - India - Israel - Italy - Japan - Malaysia - Malta - Morocco - Philippines - Singapore - Spain - Sweden - Switzerland - United Kingdom - United States of America

www.st.com

Looking for pricing, stock, or lifecycle information?

Click below to explore more details on WIN SOURCE:

-  [View LPR510AL](#) on WIN SOURCE
-  [STMicroelectronics](#) Information

Optimize Your Supply Chain with WIN SOURCE Solutions

-  Global Sourcing Solution
-  Obsolete Management
-  Cost Control Management
-  Shortage Management
-  Alternative Solution
-  Excess Inventory Management