



**THE DATASHEET OF
LQP02TN3N7B02D**



CHIP COILS (CHIP INDUCTORS) LQP02TN□□□□02□ REFERENCE SPECIFICATION

1. Scope

This reference specification applies to chip coils (chip inductors) LQP02TN_02series for general electronic equipment.

2. Part Numbering

(Ex.)									
LQ	P	02	T	N	0N2	B	0	2	D
Product ID	Structure	Dimension (L × W)	Application and characteristic	Category	Inductance	Tolerance	Performance	Electrode specification	Packaging D: 8 mm width /paper tape L: 4 mm width /plastic tape *B: bulk

*B: Bulk packing is also available (taping condition: however, products without reels are put in plastic bags).

3. Part Number and Rating

Operating temperature range	-55°C to +125°C
Storage temperature range	-55°C to +125°C

Customer Part number	Murata Part number	Inductance		Q (Min.)	DC resistance (Ω max.)	Self-resonant frequency (MHz)		Rated current (mA)
		Nominal value (nH)	Tolerance			Lower limit	*Typical value	
	LQP02TN0N2B02D	0.2	B: ±0.1 nH	-	0.50	20000	20000	320
	LQP02TN0N2B02L	0.2	B: ±0.1 nH	-	0.50	20000	20000	320
	LQP02TN0N2C02D	0.2	C: ±0.2 nH	-	0.50	20000	20000	320
	LQP02TN0N2C02L	0.2	C: ±0.2 nH	-	0.50	20000	20000	320
	LQP02TN0N3B02D	0.3	B: ±0.1 nH	-	0.50	20000	20000	320
	LQP02TN0N3B02L	0.3	B: ±0.1 nH	-	0.50	20000	20000	320
	LQP02TN0N3C02D	0.3	C: ±0.2 nH	-	0.50	20000	20000	320
	LQP02TN0N3C02L	0.3	C: ±0.2 nH	-	0.50	20000	20000	320
	LQP02TN0N4B02D	0.4	B: ±0.1 nH	8	0.50	18000	20000	320
	LQP02TN0N4B02L	0.4	B: ±0.1 nH	8	0.50	18000	20000	320
	LQP02TN0N4C02D	0.4	C: ±0.2 nH	8	0.50	18000	20000	320
	LQP02TN0N4C02L	0.4	C: ±0.2 nH	8	0.50	18000	20000	320
	LQP02TN0N5B02D	0.5	B: ±0.1 nH	8	0.50	18000	20000	320
	LQP02TN0N5B02L	0.5	B: ±0.1 nH	8	0.50	18000	20000	320
	LQP02TN0N5C02D	0.5	C: ±0.2 nH	8	0.50	18000	20000	320
	LQP02TN0N5C02L	0.5	C: ±0.2 nH	8	0.50	18000	20000	320
	LQP02TN0N6B02D	0.6	B: ±0.1 nH	8	0.50	17000	20000	320
	LQP02TN0N6B02L	0.6	B: ±0.1 nH	8	0.50	17000	20000	320
	LQP02TN0N6C02D	0.6	C: ±0.2 nH	8	0.50	17000	20000	320
	LQP02TN0N6C02L	0.6	C: ±0.2 nH	8	0.50	17000	20000	320
	LQP02TN0N7B02D	0.7	B: ±0.1 nH	8	0.50	16500	20000	320
	LQP02TN0N7B02L	0.7	B: ±0.1 nH	8	0.50	16500	20000	320
	LQP02TN0N7C02D	0.7	C: ±0.2 nH	8	0.50	16500	20000	320
	LQP02TN0N7C02L	0.7	C: ±0.2 nH	8	0.50	16500	20000	320
	LQP02TN0N8B02D	0.8	B: ±0.1 nH	8	0.50	16500	20000	320
	LQP02TN0N8B02L	0.8	B: ±0.1 nH	8	0.50	16500	20000	320
	LQP02TN0N8C02D	0.8	C: ±0.2 nH	8	0.50	16500	20000	320

Customer Part number	Murata Part number	Inductance		Q (Min.)	DC resistance (Ω max.)	Self-resonant frequency (MHz)		Rated current (mA)
		Nominal value (nH)	Tolerance			Lower limit	*Typical value	
	LQP02TN0N8C02L	0.8	C: ± 0.2 nH	8	0.50	16500	20000	320
	LQP02TN0N9B02D	0.9	B: ± 0.1 nH	8	0.50	13000	16100	320
	LQP02TN0N9B02L	0.9	B: ± 0.1 nH	8	0.50	13000	16100	320
	LQP02TN0N9C02D	0.9	C: ± 0.2 nH	8	0.50	13000	16100	320
	LQP02TN0N9C02L	0.9	C: ± 0.2 nH	8	0.50	13000	16100	320
	LQP02TN1N0B02D	1.0	B: ± 0.1 nH	8	0.60	13000	15900	220
	LQP02TN1N0B02L	1.0	B: ± 0.1 nH	8	0.60	13000	15900	220
	LQP02TN1N0C02D	1.0	C: ± 0.2 nH	8	0.60	13000	15900	220
	LQP02TN1N0C02L	1.0	C: ± 0.2 nH	8	0.60	13000	15900	220
	LQP02TN1N1B02D	1.1	B: ± 0.1 nH	8	0.60	12500	15300	220
	LQP02TN1N1B02L	1.1	B: ± 0.1 nH	8	0.60	12500	15300	220
	LQP02TN1N1C02D	1.1	C: ± 0.2 nH	8	0.60	12500	15300	220
	LQP02TN1N1C02L	1.1	C: ± 0.2 nH	8	0.60	12500	15300	220
	LQP02TN1N2B02D	1.2	B: ± 0.1 nH	8	0.60	12500	15300	220
	LQP02TN1N2B02L	1.2	B: ± 0.1 nH	8	0.60	12500	15300	220
	LQP02TN1N2C02D	1.2	C: ± 0.2 nH	8	0.60	12500	15300	220
	LQP02TN1N2C02L	1.2	C: ± 0.2 nH	8	0.60	12500	15300	220
	LQP02TN1N3B02D	1.3	B: ± 0.1 nH	8	0.60	11500	14800	220
	LQP02TN1N3B02L	1.3	B: ± 0.1 nH	8	0.60	11500	14800	220
	LQP02TN1N3C02D	1.3	C: ± 0.2 nH	8	0.60	11500	14800	220
	LQP02TN1N3C02L	1.3	C: ± 0.2 nH	8	0.60	11500	14800	220
	LQP02TN1N4B02D	1.4	B: ± 0.1 nH	8	0.60	11500	14400	220
	LQP02TN1N4B02L	1.4	B: ± 0.1 nH	8	0.60	11500	14400	220
	LQP02TN1N4C02D	1.4	C: ± 0.2 nH	8	0.60	11500	14400	220
	LQP02TN1N4C02L	1.4	C: ± 0.2 nH	8	0.60	11500	14400	220
	LQP02TN1N5B02D	1.5	B: ± 0.1 nH	8	0.60	9500	11700	220
	LQP02TN1N5B02L	1.5	B: ± 0.1 nH	8	0.60	9500	11700	220
	LQP02TN1N5C02D	1.5	C: ± 0.2 nH	8	0.60	9500	11700	220
	LQP02TN1N5C02L	1.5	C: ± 0.2 nH	8	0.60	9500	11700	220
	LQP02TN1N6B02D	1.6	B: ± 0.1 nH	8	0.60	9500	12000	220
	LQP02TN1N6B02L	1.6	B: ± 0.1 nH	8	0.60	9500	12000	220
	LQP02TN1N6C02D	1.6	C: ± 0.2 nH	8	0.60	9500	12000	220
	LQP02TN1N6C02L	1.6	C: ± 0.2 nH	8	0.60	9500	12000	220
	LQP02TN1N7B02D	1.7	B: ± 0.1 nH	8	0.70	9500	11800	200
	LQP02TN1N7B02L	1.7	B: ± 0.1 nH	8	0.70	9500	11800	200
	LQP02TN1N7C02D	1.7	C: ± 0.2 nH	8	0.70	9500	11800	200
	LQP02TN1N7C02L	1.7	C: ± 0.2 nH	8	0.70	9500	11800	200
	LQP02TN1N8B02D	1.8	B: ± 0.1 nH	8	0.70	9000	11300	200
	LQP02TN1N8B02L	1.8	B: ± 0.1 nH	8	0.70	9000	11300	200
	LQP02TN1N8C02D	1.8	C: ± 0.2 nH	8	0.70	9000	11300	200
	LQP02TN1N8C02L	1.8	C: ± 0.2 nH	8	0.70	9000	11300	200
	LQP02TN1N9B02D	1.9	B: ± 0.1 nH	8	0.75	9000	12000	200
	LQP02TN1N9B02L	1.9	B: ± 0.1 nH	8	0.75	9000	12000	200
	LQP02TN1N9C02D	1.9	C: ± 0.2 nH	8	0.75	9000	12000	200

Customer Part number	Murata Part number	Inductance		Q (Min.)	DC resistance (Ω max.)	Self-resonant frequency (MHz)		Rated current (mA)
		Nominal value (nH)	Tolerance			Lower limit	*Typical value	
	LQP02TN1N9C02L	1.9	C: ± 0.2 nH	8	0.75	9000	12000	200
	LQP02TN2N0B02D	2.0	B: ± 0.1 nH	8	0.75	9000	11100	200
	LQP02TN2N0B02L	2.0	B: ± 0.1 nH	8	0.75	9000	11100	200
	LQP02TN2N0C02D	2.0	C: ± 0.2 nH	8	0.75	9000	11100	200
	LQP02TN2N0C02L	2.0	C: ± 0.2 nH	8	0.75	9000	11100	200
	LQP02TN2N1B02D	2.1	B: ± 0.1 nH	8	0.75	9000	11200	200
	LQP02TN2N1B02L	2.1	B: ± 0.1 nH	8	0.75	9000	11200	200
	LQP02TN2N1C02D	2.1	C: ± 0.2 nH	8	0.75	9000	11200	200
	LQP02TN2N1C02L	2.1	C: ± 0.2 nH	8	0.75	9000	11200	200
	LQP02TN2N2B02D	2.2	B: ± 0.1 nH	8	0.75	7500	10000	200
	LQP02TN2N2B02L	2.2	B: ± 0.1 nH	8	0.75	7500	10000	200
	LQP02TN2N2C02D	2.2	C: ± 0.2 nH	8	0.75	7500	10000	200
	LQP02TN2N2C02L	2.2	C: ± 0.2 nH	8	0.75	7500	10000	200
	LQP02TN2N3B02D	2.3	B: ± 0.1 nH	8	0.75	7500	9700	200
	LQP02TN2N3B02L	2.3	B: ± 0.1 nH	8	0.75	7500	9700	200
	LQP02TN2N3C02D	2.3	C: ± 0.2 nH	8	0.75	7500	9700	200
	LQP02TN2N3C02L	2.3	C: ± 0.2 nH	8	0.75	7500	9700	200
	LQP02TN2N4B02D	2.4	B: ± 0.1 nH	8	0.75	7500	9500	200
	LQP02TN2N4B02L	2.4	B: ± 0.1 nH	8	0.75	7500	9500	200
	LQP02TN2N4C02D	2.4	C: ± 0.2 nH	8	0.75	7500	9500	200
	LQP02TN2N4C02L	2.4	C: ± 0.2 nH	8	0.75	7500	9500	200
	LQP02TN2N5B02D	2.5	B: ± 0.1 nH	8	0.80	7500	9300	200
	LQP02TN2N5B02L	2.5	B: ± 0.1 nH	8	0.80	7500	9300	200
	LQP02TN2N5C02D	2.5	C: ± 0.2 nH	8	0.80	7500	9300	200
	LQP02TN2N5C02L	2.5	C: ± 0.2 nH	8	0.80	7500	9300	200
	LQP02TN2N6B02D	2.6	B: ± 0.1 nH	8	0.80	7500	9100	200
	LQP02TN2N6B02L	2.6	B: ± 0.1 nH	8	0.80	7500	9100	200
	LQP02TN2N6C02D	2.6	C: ± 0.2 nH	8	0.80	7500	9100	200
	LQP02TN2N6C02L	2.6	C: ± 0.2 nH	8	0.80	7500	9100	200
	LQP02TN2N7B02D	2.7	B: ± 0.1 nH	8	0.80	7500	9200	200
	LQP02TN2N7B02L	2.7	B: ± 0.1 nH	8	0.80	7500	9200	200
	LQP02TN2N7C02D	2.7	C: ± 0.2 nH	8	0.80	7500	9200	200
	LQP02TN2N7C02L	2.7	C: ± 0.2 nH	8	0.80	7500	9200	200
	LQP02TN2N8B02D	2.8	B: ± 0.1 nH	8	1.10	7500	12000	200
	LQP02TN2N8B02L	2.8	B: ± 0.1 nH	8	1.10	7500	12000	200
	LQP02TN2N8C02D	2.8	C: ± 0.2 nH	8	1.10	7500	12000	200
	LQP02TN2N8C02L	2.8	C: ± 0.2 nH	8	1.10	7500	12000	200
	LQP02TN2N9B02D	2.9	B: ± 0.1 nH	8	1.10	7500	11800	200
	LQP02TN2N9B02L	2.9	B: ± 0.1 nH	8	1.10	7500	11800	200
	LQP02TN2N9C02D	2.9	C: ± 0.2 nH	8	1.10	7500	11800	200
	LQP02TN2N9C02L	2.9	C: ± 0.2 nH	8	1.10	7500	11800	200
	LQP02TN3N0B02D	3.0	B: ± 0.1 nH	8	1.10	7500	11800	200
	LQP02TN3N0B02L	3.0	B: ± 0.1 nH	8	1.10	7500	11800	200
	LQP02TN3N0C02D	3.0	C: ± 0.2 nH	8	1.10	7500	11800	200

Customer Part number	Murata Part number	Inductance		Q (Min.)	DC resistance (Ω max.)	Self-resonant frequency (MHz)		Rated current (mA)
		Nominal value (nH)	Tolerance			Lower limit	*Typical value	
	LQP02TN3N0C02L	3.0	C: ± 0.2 nH	8	1.10	7500	11800	200
	LQP02TN3N1B02D	3.1	B: ± 0.1 nH	8	1.30	7500	12000	180
	LQP02TN3N1B02L	3.1	B: ± 0.1 nH	8	1.30	7500	12000	180
	LQP02TN3N1C02D	3.1	C: ± 0.2 nH	8	1.30	7500	12000	180
	LQP02TN3N1C02L	3.1	C: ± 0.2 nH	8	1.30	7500	12000	180
	LQP02TN3N2B02D	3.2	B: ± 0.1 nH	8	1.30	7500	10400	180
	LQP02TN3N2B02L	3.2	B: ± 0.1 nH	8	1.30	7500	10400	180
	LQP02TN3N2C02D	3.2	C: ± 0.2 nH	8	1.30	7500	10400	180
	LQP02TN3N2C02L	3.2	C: ± 0.2 nH	8	1.30	7500	10400	180
	LQP02TN3N3B02D	3.3	B: ± 0.1 nH	8	1.30	7500	10400	180
	LQP02TN3N3B02L	3.3	B: ± 0.1 nH	8	1.30	7500	10400	180
	LQP02TN3N3C02D	3.3	C: ± 0.2 nH	8	1.30	7500	10400	180
	LQP02TN3N3C02L	3.3	C: ± 0.2 nH	8	1.30	7500	10400	180
	LQP02TN3N4B02D	3.4	B: ± 0.1 nH	8	1.30	7500	10400	180
	LQP02TN3N4B02L	3.4	B: ± 0.1 nH	8	1.30	7500	10400	180
	LQP02TN3N4C02D	3.4	C: ± 0.2 nH	8	1.30	7500	10400	180
	LQP02TN3N4C02L	3.4	C: ± 0.2 nH	8	1.30	7500	10400	180
	LQP02TN3N5B02D	3.5	B: ± 0.1 nH	8	1.30	7500	10200	180
	LQP02TN3N5B02L	3.5	B: ± 0.1 nH	8	1.30	7500	10200	180
	LQP02TN3N5C02D	3.5	C: ± 0.2 nH	8	1.30	7500	10200	180
	LQP02TN3N5C02L	3.5	C: ± 0.2 nH	8	1.30	7500	10200	180
	LQP02TN3N6B02D	3.6	B: ± 0.1 nH	8	1.30	7500	10100	180
	LQP02TN3N6B02L	3.6	B: ± 0.1 nH	8	1.30	7500	10100	180
	LQP02TN3N6C02D	3.6	C: ± 0.2 nH	8	1.30	7500	10100	180
	LQP02TN3N6C02L	3.6	C: ± 0.2 nH	8	1.30	7500	10100	180
	LQP02TN3N7B02D	3.7	B: ± 0.1 nH	8	1.30	7500	10300	180
	LQP02TN3N7B02L	3.7	B: ± 0.1 nH	8	1.30	7500	10300	180
	LQP02TN3N7C02D	3.7	C: ± 0.2 nH	8	1.30	7500	10300	180
	LQP02TN3N7C02L	3.7	C: ± 0.2 nH	8	1.30	7500	10300	180
	LQP02TN3N8B02D	3.8	B: ± 0.1 nH	8	1.30	7500	10100	180
	LQP02TN3N8B02L	3.8	B: ± 0.1 nH	8	1.30	7500	10100	180
	LQP02TN3N8C02D	3.8	C: ± 0.2 nH	8	1.30	7500	10100	180
	LQP02TN3N8C02L	3.8	C: ± 0.2 nH	8	1.30	7500	10100	180
	LQP02TN3N9B02D	3.9	B: ± 0.1 nH	8	1.30	7500	9700	180
	LQP02TN3N9B02L	3.9	B: ± 0.1 nH	8	1.30	7500	9700	180
	LQP02TN3N9C02D	3.9	C: ± 0.2 nH	8	1.30	7500	9700	180
	LQP02TN3N9C02L	3.9	C: ± 0.2 nH	8	1.30	7500	9700	180
	LQP02TN4N0B02D	4.0	B: ± 0.1 nH	8	1.30	7500	9800	180
	LQP02TN4N0B02L	4.0	B: ± 0.1 nH	8	1.30	7500	9800	180
	LQP02TN4N0C02D	4.0	C: ± 0.2 nH	8	1.30	7500	9800	180
	LQP02TN4N0C02L	4.0	C: ± 0.2 nH	8	1.30	7500	9800	180
	LQP02TN4N1B02D	4.1	B: ± 0.1 nH	8	1.30	7500	9600	180
	LQP02TN4N1B02L	4.1	B: ± 0.1 nH	8	1.30	7500	9600	180
	LQP02TN4N1C02D	4.1	C: ± 0.2 nH	8	1.30	7500	9600	180

Customer Part number	Murata Part number	Inductance		Q (Min.)	DC resistance (Ω max.)	Self-resonant frequency (MHz)		Rated current (mA)
		Nominal value (nH)	Tolerance			Lower limit	*Typical value	
	LQP02TN4N1C02L	4.1	C: ± 0.2 nH	8	1.30	7500	9600	180
	LQP02TN4N2B02D	4.2	B: ± 0.1 nH	8	1.30	7000	8700	180
	LQP02TN4N2B02L	4.2	B: ± 0.1 nH	8	1.30	7000	8700	180
	LQP02TN4N2C02D	4.2	C: ± 0.2 nH	8	1.30	7000	8700	180
	LQP02TN4N2C02L	4.2	C: ± 0.2 nH	8	1.30	7000	8700	180
	LQP02TN4N3H02D	4.3	H: $\pm 3\%$	8	1.30	7000	8800	180
	LQP02TN4N3H02L	4.3	H: $\pm 3\%$	8	1.30	7000	8800	180
	LQP02TN4N3J02D	4.3	J: $\pm 5\%$	8	1.30	7000	8800	180
	LQP02TN4N3J02L	4.3	J: $\pm 5\%$	8	1.30	7000	8800	180
	LQP02TN4N7H02D	4.7	H: $\pm 3\%$	8	1.50	6500	8600	160
	LQP02TN4N7H02L	4.7	H: $\pm 3\%$	8	1.50	6500	8600	160
	LQP02TN4N7J02D	4.7	J: $\pm 5\%$	8	1.50	6500	8600	160
	LQP02TN4N7J02L	4.7	J: $\pm 5\%$	8	1.50	6500	8600	160
	LQP02TN5N1H02D	5.1	H: $\pm 3\%$	8	1.50	6500	8300	160
	LQP02TN5N1H02L	5.1	H: $\pm 3\%$	8	1.50	6500	8300	160
	LQP02TN5N1J02D	5.1	J: $\pm 5\%$	8	1.50	6500	8300	160
	LQP02TN5N1J02L	5.1	J: $\pm 5\%$	8	1.50	6500	8300	160
	LQP02TN5N6H02D	5.6	H: $\pm 3\%$	8	1.80	6000	7500	140
	LQP02TN5N6H02L	5.6	H: $\pm 3\%$	8	1.80	6000	7500	140
	LQP02TN5N6J02D	5.6	J: $\pm 5\%$	8	1.80	6000	7500	140
	LQP02TN5N6J02L	5.6	J: $\pm 5\%$	8	1.80	6000	7500	140
	LQP02TN6N2H02D	6.2	H: $\pm 3\%$	8	1.80	5500	7400	140
	LQP02TN6N2H02L	6.2	H: $\pm 3\%$	8	1.80	5500	7400	140
	LQP02TN6N2J02D	6.2	J: $\pm 5\%$	8	1.80	5500	7400	140
	LQP02TN6N2J02L	6.2	J: $\pm 5\%$	8	1.80	5500	7400	140
	LQP02TN6N8H02D	6.8	H: $\pm 3\%$	8	2.00	5500	7100	140
	LQP02TN6N8H02L	6.8	H: $\pm 3\%$	8	2.00	5500	7100	140
	LQP02TN6N8J02D	6.8	J: $\pm 5\%$	8	2.00	5500	7100	140
	LQP02TN6N8J02L	6.8	J: $\pm 5\%$	8	2.00	5500	7100	140
	LQP02TN7N5H02D	7.5	H: $\pm 3\%$	8	2.00	4500	6500	140
	LQP02TN7N5H02L	7.5	H: $\pm 3\%$	8	2.00	4500	6500	140
	LQP02TN7N5J02D	7.5	J: $\pm 5\%$	8	2.00	4500	6500	140
	LQP02TN7N5J02L	7.5	J: $\pm 5\%$	8	2.00	4500	6500	140
	LQP02TN8N2H02D	8.2	H: $\pm 3\%$	8	2.10	4500	6200	140
	LQP02TN8N2H02L	8.2	H: $\pm 3\%$	8	2.10	4500	6200	140
	LQP02TN8N2J02D	8.2	J: $\pm 5\%$	8	2.10	4500	6200	140
	LQP02TN8N2J02L	8.2	J: $\pm 5\%$	8	2.10	4500	6200	140
	LQP02TN9N1H02D	9.1	H: $\pm 3\%$	8	2.10	4000	5600	140
	LQP02TN9N1H02L	9.1	H: $\pm 3\%$	8	2.10	4000	5600	140
	LQP02TN9N1J02D	9.1	J: $\pm 5\%$	8	2.10	4000	5600	140
	LQP02TN9N1J02L	9.1	J: $\pm 5\%$	8	2.10	4000	5600	140
	LQP02TN10NH02D	10	H: $\pm 3\%$	8	2.50	4000	5300	140
	LQP02TN10NH02L	10	H: $\pm 3\%$	8	2.50	4000	5300	140
	LQP02TN10NJ02D	10	J: $\pm 5\%$	8	2.50	4000	5300	140

Customer Part number	Murata Part number	Inductance		Q (Min.)	DC resistance (Ω max.)	Self-resonant frequency (MHz)		Rated current (mA)
		Nominal value (nH)	Tolerance			Lower limit	*Typical value	
	LQP02TN10NJ02L	10	J: $\pm 5\%$	8	2.50	4000	5300	140
	LQP02TN11NH02D	11	H: $\pm 3\%$	7	2.80	3500	4400	140
	LQP02TN11NH02L	11	H: $\pm 3\%$	7	2.80	3500	4400	140
	LQP02TN11NJ02D	11	J: $\pm 5\%$	7	2.80	3500	4400	140
	LQP02TN11NJ02L	11	J: $\pm 5\%$	7	2.80	3500	4400	140
	LQP02TN12NH02D	12	H: $\pm 3\%$	7	2.80	3500	4200	140
	LQP02TN12NH02L	12	H: $\pm 3\%$	7	2.80	3500	4200	140
	LQP02TN12NJ02D	12	J: $\pm 5\%$	7	2.80	3500	4200	140
	LQP02TN12NJ02L	12	J: $\pm 5\%$	7	2.80	3500	4200	140
	LQP02TN13NH02D	13	H: $\pm 3\%$	7	3.20	3000	4200	140
	LQP02TN13NH02L	13	H: $\pm 3\%$	7	3.20	3000	4200	140
	LQP02TN13NJ02D	13	J: $\pm 5\%$	7	3.20	3000	4200	140
	LQP02TN13NJ02L	13	J: $\pm 5\%$	7	3.20	3000	4200	140
	LQP02TN15NH02D	15	H: $\pm 3\%$	7	3.20	3000	3800	140
	LQP02TN15NH02L	15	H: $\pm 3\%$	7	3.20	3000	3800	140
	LQP02TN15NJ02D	15	J: $\pm 5\%$	7	3.20	3000	3800	140
	LQP02TN15NJ02L	15	J: $\pm 5\%$	7	3.20	3000	3800	140
	LQP02TN16NH02D	16	H: $\pm 3\%$	7	3.50	2500	3600	140
	LQP02TN16NH02L	16	H: $\pm 3\%$	7	3.50	2500	3600	140
	LQP02TN16NJ02D	16	J: $\pm 5\%$	7	3.50	2500	3600	140
	LQP02TN16NJ02L	16	J: $\pm 5\%$	7	3.50	2500	3600	140
	LQP02TN18NH02D	18	H: $\pm 3\%$	7	3.50	2500	3400	140
	LQP02TN18NH02L	18	H: $\pm 3\%$	7	3.50	2500	3400	140
	LQP02TN18NJ02D	18	J: $\pm 5\%$	7	3.50	2500	3400	140
	LQP02TN18NJ02L	18	J: $\pm 5\%$	7	3.50	2500	3400	140
	LQP02TN20NH02D	20	H: $\pm 3\%$	6	5.00	2300	3100	120
	LQP02TN20NH02L	20	H: $\pm 3\%$	6	5.00	2300	3100	120
	LQP02TN20NJ02D	20	J: $\pm 5\%$	6	5.00	2300	3100	120
	LQP02TN20NJ02L	20	J: $\pm 5\%$	6	5.00	2300	3100	120
	LQP02TN22NH02D	22	H: $\pm 3\%$	6	5.00	2300	3000	120
	LQP02TN22NH02L	22	H: $\pm 3\%$	6	5.00	2300	3000	120
	LQP02TN22NJ02D	22	J: $\pm 5\%$	6	5.00	2300	3000	120
	LQP02TN22NJ02L	22	J: $\pm 5\%$	6	5.00	2300	3000	120
	LQP02TN24NH02D	24	H: $\pm 3\%$	6	5.50	2000	2800	120
	LQP02TN24NH02L	24	H: $\pm 3\%$	6	5.50	2000	2800	120
	LQP02TN24NJ02D	24	J: $\pm 5\%$	6	5.50	2000	2800	120
	LQP02TN24NJ02L	24	J: $\pm 5\%$	6	5.50	2000	2800	120
	LQP02TN27NH02D	27	H: $\pm 3\%$	6	5.50	2000	2500	120
	LQP02TN27NH02L	27	H: $\pm 3\%$	6	5.50	2000	2500	120
	LQP02TN27NJ02D	27	J: $\pm 5\%$	6	5.50	2000	2500	120
	LQP02TN27NJ02L	27	J: $\pm 5\%$	6	5.50	2000	2500	120
	LQP02TN30NH02D	30	H: $\pm 3\%$	6	6.50	1800	2600	90
	LQP02TN30NH02L	30	H: $\pm 3\%$	6	6.50	1800	2600	90
	LQP02TN30NJ02D	30	J: $\pm 5\%$	6	6.50	1800	2600	90

Customer Part number	Murata Part number	Inductance		Q (Min.)	DC resistance (Ω max.)	Self-resonant frequency (MHz)		Rated current (mA)
		Nominal value (nH)	Tolerance			Lower limit	*Typical value	
	LQP02TN30NJ02L	30	J: $\pm 5\%$	6	6.50	1800	2600	90
	LQP02TN33NH02D	33	H: $\pm 3\%$	4	6.50	1800	2300	90
	LQP02TN33NH02L	33	H: $\pm 3\%$	4	6.50	1800	2300	90
	LQP02TN33NJ02D	33	J: $\pm 5\%$	4	6.50	1800	2300	90
	LQP02TN33NJ02L	33	J: $\pm 5\%$	4	6.50	1800	2300	90
	LQP02TN36NH02D	36	H: $\pm 3\%$	4	7.00	1600	2300	90
	LQP02TN36NH02L	36	H: $\pm 3\%$	4	7.00	1600	2300	90
	LQP02TN36NJ02D	36	J: $\pm 5\%$	4	7.00	1600	2300	90
	LQP02TN36NJ02L	36	J: $\pm 5\%$	4	7.00	1600	2300	90
	LQP02TN39NH02D	39	H: $\pm 3\%$	4	7.00	1600	2100	90
	LQP02TN39NH02L	39	H: $\pm 3\%$	4	7.00	1600	2100	90
	LQP02TN39NJ02D	39	J: $\pm 5\%$	4	7.00	1600	2100	90
	LQP02TN39NJ02L	39	J: $\pm 5\%$	4	7.00	1600	2100	90

* Typical value is actual performance.

4. Testing Conditions

Unless otherwise specified	Temperature: ordinary temperature (15°C to 35°C) Humidity: ordinary humidity [25% to 85% (RH)]
In case of doubt	Temperature: 20°C \pm 2°C Humidity: 60% to 70% (RH) Atmospheric pressure: 86 kPa to 106 kPa

5. Appearance and Dimensions

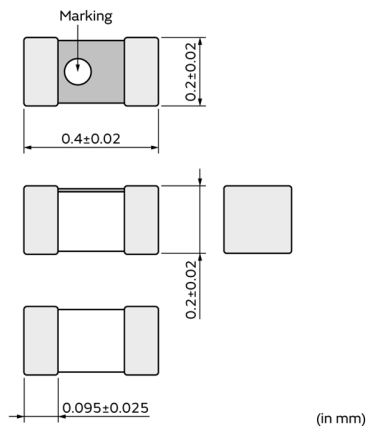

Unit mass (typical value): 0.05 mg

6. Marking

Direction identification marking: white

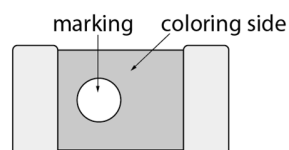

7. Electrical Performance

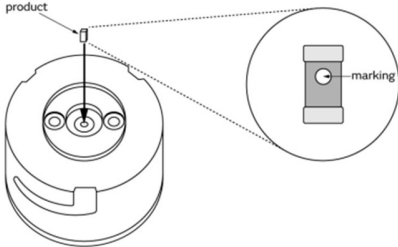
No.	Item	Specification	Test method				
7.1	Inductance	Meet chapter 3 ratings.	Measuring equipment: Keysight E4991A or the equivalent Measuring frequency: <table border="1" style="margin-left: 20px;"> <tr> <td>500 MHz</td> <td>0.2 nH to 30 nH</td> </tr> <tr> <td>300 MHz</td> <td>33 nH to 39 nH</td> </tr> </table> Measuring conditions: Measurement signal level: Approx. 0 dBm Electrical length: 27.3 mm Weight: Approx. 3 N Measuring fixture: Keysight 16196D Position the chip coil under test as shown in the measuring example below and connect it to the electrode by applying weight. Measurement example: <div style="text-align: center; margin: 10px 0;">  </div> Product insertion hole: $\varnothing 0.3$ mm Measuring method: see "Electrical performance: Measuring method for inductance/Q" in the Appendix.	500 MHz	0.2 nH to 30 nH	300 MHz	33 nH to 39 nH
500 MHz	0.2 nH to 30 nH						
300 MHz	33 nH to 39 nH						
7.2	Q	Meet chapter 3 ratings.					
7.3	DC resistance	Meet chapter 3 ratings.	Measuring equipment: digital multimeter				
7.4	Self-resonant frequency	Meet chapter 3 ratings.	Measuring equipment: Keysight 8753C or the equivalent				
7.5	Rated current	Product temperature rise: 25°C max.	Apply the rated current specified in chapter 3.				

8. Mechanical Performance

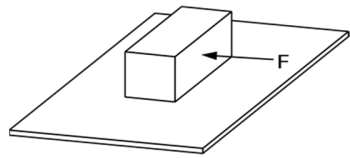
No.	Item	Specification	Test method
8.1	Shear test	No significant mechanical damage or no sign of electrode peeling off shall be observed.	Test substrate: glass-epoxy substrate Applying force: 1 N Holding time: 5 \pm 1 s Force application direction: <div style="text-align: center; margin: 10px 0;">  </div>
8.2	Bending test	No significant mechanical damage or no sign of electrode peeling off shall be observed.	Test substrate: glass-epoxy substrate (100 mm \times 40 mm \times 0.8 mm) Pressurizing speed: 1 mm/s Pressure jig: R340 Deflection: 1 mm Holding time: 30 s

No.	Item	Specification	Test method
8.3	Vibration	Appearance shall have no significant mechanical damage.	<p>Oscillation frequency: 10 Hz to 2000 Hz to 10 Hz, for approx. 20 min</p> <p>Total amplitude: total amplitude of 1.5 mm or acceleration amplitude of 196 m/s², whichever is smaller</p> <p>Test time: 3 directions perpendicular to each other, 2 h for each direction (6 h in total)</p>
8.4	Solderability	90% or more of the outer electrode shall be covered with new solder seamlessly.	<p>Flux: immersed in ethanol solution with a rosin content of 25(wt)% for 5 s to 10 s</p> <p>Solder: Sn-3.0Ag-0.5Cu solder</p> <p>Pre-heating: 150°C±10°C/60 s to 90 s</p> <p>Solder temperature: 240°C±5°C</p> <p>Immersion time: 3 s±1 s</p>
8.5	Resistance to soldering heat	Appearance: No significant mechanical damage shall be observed. Inductance change rate: within ±10%	<p>Flux: immersed in ethanol solution with a rosin content of 25(wt)% for 5 s to 10 s</p> <p>Solder: Sn-3.0Ag-0.5Cu solder</p> <p>Pre-heating: 150°C±10°C/60 s to 90 s</p> <p>Solder temperature: 260°C±5°C</p> <p>Immersion time: 5 s±1 s</p> <p>Post-treatment: left at a room condition for 24 h±2 h</p>

9. Environmental Performance

The product is soldered on a glass-epoxy substrate for test.

No.	Item	Specification	Test method
9.1	Heat resistance	Appearance: No significant mechanical damage shall be observed. Inductance change rate: within ±10%	<p>Temperature: 125°C±2°C</p> <p>Test time: 1000 h (+48 h, -0 h)</p> <p>Post-treatment: left at a room condition for 24 h±2 h</p>
9.2	Cold resistance	Appearance: No significant mechanical damage shall be observed. Inductance change rate: within ±10%	<p>Temperature: -55°C±3°C</p> <p>Test time: 1000 h (+48 h, -0 h)</p> <p>Post-treatment: left at a room condition for 24 h±2 h</p>
9.3	Humidity	Appearance: No significant mechanical damage shall be observed. Inductance change rate: within ±10%	<p>Temperature: 40°C±2°C</p> <p>Humidity: 90% (RH) to 95% (RH)</p> <p>Test time: 1000 h (+48 h, -0 h)</p> <p>Post-treatment: left at a room condition for 24 h±2 h</p>
9.4	Temperature cycle	Appearance: No significant mechanical damage shall be observed. Inductance change rate: within ±10%	<p>Single cycle conditions:</p> <p>Step 1: -55°C±2°C/30 min±3 min</p> <p>Step 2: ordinary temperature/10 min to 15 min</p> <p>Step 3: +125°C±2°C/30 min±3 min</p> <p>Step 4: ordinary temperature/10 min to 15 min</p> <p>Number of testing: 10 cycles</p> <p>Post-treatment: left at a room condition for 24 h±2 h</p>

10.4 Peeling off force of tape

Speed of peeling off	300 mm/min
Peeling off force	0.1 N to 0.6 N (The lower limit is for typical value.)



10.5 Dimensions of leader section, trailer section and reel

A vacant section is provided in the leader (start) section and trailer (end) section of the tape for the product. The leader section is further provided with an area consisting only of the cover tape (or top tape). (See the diagram below.)

- 8 mm width carrier tape



- 4 mm width carrier tape



10.6 Marking for reel

Customer part number, Murata part number, inspection number (*1), RoHS marking (*2), quantity, etc.

*1 Expression of inspection No.:	(1) Factory code (2) Date First digit: year/last digit of year Second digit: month/Jan. to Sep. → 1 to 9, Oct. to Dec. → O, N, D Third, Fourth digit: day (3) Serial No.
*2 Expression of RoHS marking:	(1) RoHS regulation conformity (2) Murata classification number

10.7 Marking on outer box (corrugated box)

Customer name, purchasing order number, customer part number, Murata part number, RoHS marking (*2), quantity, etc.

10.8 Specification of outer box



Dimensions of outer box (mm)			Tape width (mm)	Standard reel quantity in outer box(reel)
W	D	H		
186	186	93	4	10
			8	5
* Above outer box size is typical. It depends on a quantity of an order.				

11. ⚠Caution

11.1 Restricted applications

Please contact us before using our products for the applications listed below which require especially high reliability for the prevention of defects which might directly cause damage to the third party's life, body or property.

- | | | | |
|-------------------------------|---|------------------------------|---|
| (1) Aircraft equipment | (2) Aerospace equipment | (3) Undersea equipment | (4) Power plant control equipment |
| (5) Medical equipment | (6) Transportation equipment (vehicles, trains, ships, etc.) | (7) Traffic signal equipment | (8) Disaster/crime prevention equipment |
| (9) Data-processing equipment | (10) Applications of similar complexity and/or reliability requirements to the applications listed in the above | | |

11.2 Precautions on rating

Avoid using in exceeded the rated temperature range, rated voltage, or rated current. Usage when the ratings are exceeded could lead to wire breakage, burning, or other serious fault.

11.3 Inrush current

If an inrush current (or pulse current or rush current) that significantly exceeds the rated current is applied to the product, overheating could occur, resulting in wire breakage, burning, or other serious fault.

12. Precautions for Use

This product is for use only with reflow soldering. It is designed to be mounted by soldering. If you want to use other mounting method, for example, using a conductive adhesive, please consult us beforehand.

Also, if repeatedly subjected to temperature cycles or other thermal stress, due to the difference in the coefficient of thermal expansion with the mounting substrate, the solder (solder fillet part) in the mounting part may crack.

The occurrence of cracks due to thermal stress is affected by the size of the land where mounted, the solder volume, and the heat dissipation of the mounting substrate. Carefully design it when a large change in ambient temperature is assumed.

12.1. Land dimensions

The following diagram shows the recommended land dimensions for reflow soldering:



12.2 Flux and solder used

Flux	<ul style="list-style-type: none"> • Use a rosin-based flux. • Do not use a highly acidic flux with a halide content exceeding 0.2(wt)% (chlorine conversion value). • Do not use a water-soluble flux.
Solder	<ul style="list-style-type: none"> • Use Sn-3.0Ag-0.5Cu solder. • Standard thickness of solder paste: 50 μm to 80 μm

If you want to use a flux other than the above, please consult our technical department.

12.3 Soldering conditions (reflow)

- Pre-heating should be in such a way that the temperature difference between solder and product surface is limited to 150°C max.
Cooling into solvent after soldering also should be in such a way that the temperature difference is limited to 100°C max. Insufficient pre-heating may cause cracks on the product, resulting in the deterioration of product quality.
- Standard soldering profile and the limit soldering profile is as follows.
The excessive limit soldering conditions may cause leaching of the electrode and/or resulting in the deterioration of product quality.

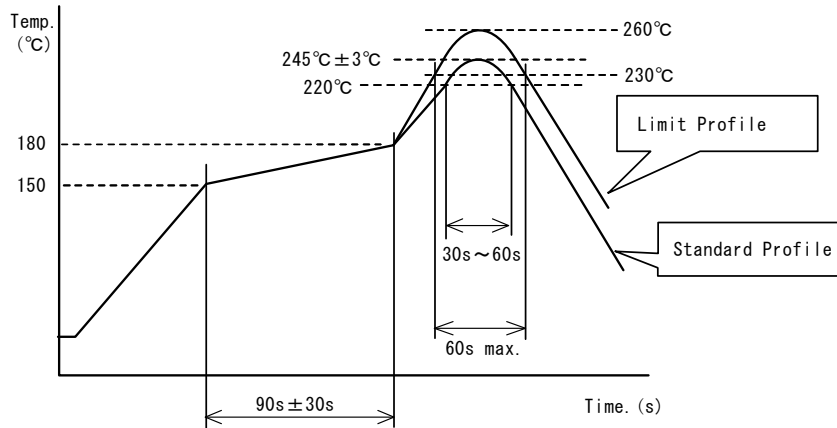

	Standard profile	Limit profile
Pre-heating	150°C to 180°C/90 s ± 30 s	150°C to 180°C/90 s ± 30 s
Heating	Above 220°C/30 s to 60 s	Above 230°C/60 s max.
Peak temperature	245°C ± 3°C	260°C/10 s
Number of reflow cycles	2 times	2 times

12.4 Reworking with soldering iron

Do not perform reworking with a soldering iron on this product.

12.5 Solder volume

Solder shall be used not to be exceeded the upper limits as shown below.

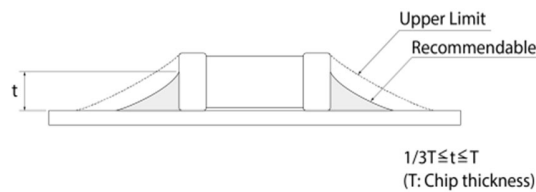

An increased solder volume increases mechanical stress on the product. Exceeding solder volume may cause the failure of mechanical or electrical performance.

12.6 Product's location

The following shall be considered when designing and laying out PCBs.

- PCB shall be designed so that products are not subject to mechanical stress due to warping the board.

[Products direction]

Products shall be located in the sideways direction (length: $a < b$) to the mechanical stress.

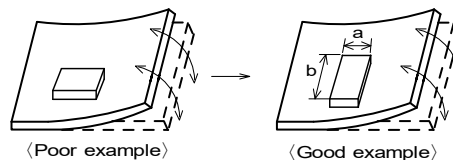

(2) Components location on PCB separation

It is effective to implement the following measures, to reduce stress in separating the board.

It is best to implement all of the following three measures; however, implement as many measures as possible to reduce stress.

Contents of measures	Stress level
(1) Turn the mounting direction of the component parallel to the board separation surface.	$A > D^{*1}$
(2) Add slits in the board separation part.	$A > B$
(3) Keep the mounting position of the component away from the board separation surface.	$A > C$
*1 $A > D$ is valid when stress is added vertically to the perforation as with hand separation. If a cutting disc is used, stress will be diagonal to the PCB, therefore $A > D$ is invalid.	



(3) Mounting components near screw holes

When a component is mounted near a screw hole, it may be affected by the board deflection that occurs during the tightening of the screw.

Mount the component in a position as far away from the screw holes as possible.



12.7 Handling of substrate

(1) The stress applied to the chip varies depending on the material and construction of the mounted substrate.

If the coefficients of thermal expansion for the substrate and chip vary significantly, the difference in thermal expansion and shrinkage could cause cracks to form in the chip.

We assume that the products are mounted on glass-epoxy substrate. Assessment has not been conducted on substrates where the coefficient of thermal expansion varies significantly from glass-epoxy substrates. If mounting on these substrates, be sure to conduct full assessments before use.

(2) After mounting products on a substrate, do not apply any stress to the product caused by bending or twisting to the substrate when cropping the substrate, inserting and removing a connector from the substrate or tightening screw to the substrate.

Excessive mechanical stress may cause cracking in the product.

Also, if mounting on flexible substrates, excessive mechanical stress could be applied to the chip by even slight bending or twisting when handling this substrate, and so please conduct full assessments before use.



Bending

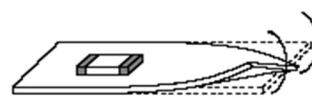

Twisting

12.8 Cleaning

The product shall be cleaned under the following conditions.

- (1) The cleaning temperature shall be 60°C max. If isopropyl alcohol (IPA) is used, the cleaning temperature shall be 40°C max.
- (2) Perform ultrasonic cleaning under the following conditions. Exercise caution to prevent resonance phenomenon in mounted products and the PCB.

Item	Requirement
Power	20 W/L max.
Time	5 min max.
Frequency	28 kHz to 40 kHz

- (3) Cleaner

Alcohol-based cleaner: IPA

Aqueous agent: PINE ALPHA ST-100S

- (4) There shall be no residual flux or residual cleaner. When using aqueous agent, rinse the product with deionized water adequately and completely dry it so that no cleaner is left.

* For other cleaning, consult our technical department.

12.9 Storage and transportation

Storage period	Use the product within 12 months after delivery. If you do not use the product for more than 12 months, check solderability before using it.
Storage conditions	<ul style="list-style-type: none"> • The products shall be stored in a room not subject to rapid changes in temperature and humidity. The recommended temperature range is -10°C to +40°C. The recommended relative humidity range is 15% to 85%. Keeping the product in corrosive gases, such as sulfur, chlorine gas or acid may cause the poor solderability. • Do not place the products directly on the floor; they should be placed on a palette so that they are not affected by humidity or dust. • Avoid keeping the products in a place exposed to direct sunlight, heat or vibration. • Do not keep products in bulk packaging. Bulk storage could result in collisions between the products or between the products and other parts, resulting in chipping or wire breakage. • Avoid storing the product by itself bare (i.e. exposed directly to air).
Transportation	Excessive vibration and impact reduces the reliability of the products. Exercise caution when handling the products.

12.10 Resin coating (including moisture-proof coating)

Before applying any resin coating, please consult our technical department.

12.11 Mounting conditions

Check the mounting condition before using.

Using mounting conditions (nozzles, equipment conditions, etc.) that are not suitable for products may lead to pick up errors, misalignment, or damage to the product.

12.12 Operating environment

Do not use this product under the following environmental conditions as it may cause deterioration of product quality.

- (1) In the corrodible atmosphere such as acidic gases, alkaline gases, chlorine, sulfur gases, organic gases and etc. (the sea breeze, Cl₂, H₂S, NH₃, SO₂, NO₂, etc)
- (2) In the atmosphere where liquid such as organic solvent, may splash on the products.
- (3) In the atmosphere where the temperature/humidity changes rapidly and it is easy to dew.

12.13 Mounting density

If this product is placed near heat-generating products, be sure to implement sufficient heat-dissipating measures.

If this product is subjected to a significant amount of heat from other products, this could adversely affect product quality, resulting in a circuit malfunction or failure of the mounted section. Also, be sure that the product is used in a manner so that the heat that the product is subjected to from other products does not exceed the upper limit of the rated operating temperature for the product.

13.  Note

- (1) Please make sure that your product has been evaluated in view of your specifications with our product being mounted to your product.
- (2) You are requested not to use our product deviating from the reference specifications.
- (3) The contents of this reference specification are subject to change without advance notice. Please approve our product specifications or transact the approval sheet for product specifications before ordering.

Appendix

Electrical performance: Measuring method for inductance/Q (Q measurement is applicable only when the Q value is included in the rating table.)

Perform measurement using the method described below. (Perform correction for the error deriving from the measuring terminal.)

(1) Residual elements and stray elements of the measuring terminal can be expressed by the F parameter for the 2-pole terminal as shown in the figure below.



(2) The product's impedance value (Z_x) and measured impedance value (Z_m) can be expressed as shown below, by using the respective current and voltage for input/output.

$$Z_m = \frac{V_1}{I_1} \quad Z_x = \frac{V_2}{I_2}$$

(3) Thus, the relationship between the product's impedance value (Z_x) and measured impedance value (Z_m) is as follows.

$Z_x = \alpha \frac{Z_m - \beta}{1 - Z_m \Gamma}$	<p>Here,</p> <p>$\alpha = D/A = 1$</p> <p>$\beta = B/D = Z_{sm} - (1 - Y_{om} Z_{sm}) Z_{ss}$</p> <p>$\Gamma = C/A = Y_{om}$</p> <p>$Z_{sm}$: measured impedance of short chip</p> <p>Z_{ss}: residual impedance of short chip (0.110 nH)</p> <p>Y_{om}: measured admittance when measuring terminal is open</p>
---	--

(4) Calculate inductance L_x and Q_x using the equations shown below.

$L_x = \frac{\text{Im}(Z_x)}{2\pi f}$	<p>L_x: inductance of chip coil</p>
$Q_x = \frac{\text{Im}(Z_x)}{\text{Re}(Z_x)}$	<p>Q_x: Q of chip coil</p> <p>f: measuring frequency</p>

Looking for pricing, stock, or lifecycle information?

Click below to explore more details on WIN SOURCE:

- ⊖ [View LQP02TN3N7B02D on WIN SOURCE](#)
- ⊖ [Murata Electronics North America Information](#)

Optimize Your Supply Chain with WIN SOURCE Solutions

- ✓ Global Sourcing Solution
- ✓ Obsolete Management
- ✓ Cost Control Management
- ✓ Shortage Management
- ✓ Alternative Solution
- ✓ Excess Inventory Management