



**THE DATASHEET OF
LT1529IQ-3.3#TRPBF**



3A Low Dropout Regulators with Micropower Quiescent Current and Shutdown

FEATURES

- Dropout Voltage: 0.6V at $I_{OUT} = 3A$
- Output Current: 3A
- Quiescent Current: 50 μA
- No Protection Diodes Needed
- Adjustable Output from 3.8V to 14V
- 3.3V and 5V Fixed Output Voltages
- Controlled Quiescent Current in Dropout
- Shutdown $I_Q = 16\mu A$
- Stable with 22 μF Output Capacitor
- Reverse Battery Protection
- No Reverse Current
- Thermal Limiting

APPLICATIONS

- High Efficiency Regulator
- Regulator for Battery-Powered Systems
- Post Regulator for Switching Supplies
- 5V to 3.3V Logic Regulator

LT, LTC and LT are registered trademarks of Linear Technology Corporation. All other trademarks are the property of their respective owners.

DESCRIPTION

The LT[®]1529/LT1529-3.3/LT1529-5 are 3A low dropout regulators with micropower quiescent current and shutdown. The devices are capable of supplying 3A of output current with a dropout voltage of 0.6V. Designed for use in battery-powered systems, the low quiescent current, 50 μA operating and 16 μA in shutdown, make them an ideal choice. The quiescent current is well controlled; it does not rise in dropout as it does with many other low dropout PNP regulators.

Other features of the LT1529 /LT1529-3.3/LT1529-5 include the ability to operate with small output capacitors. They are stable with 22 μF on the output while most older devices require up to 100 μF for stability. Small ceramic capacitors can be used, enhancing manufacturability. Also the input may be connected to voltages lower than the output voltage, including negative voltages, without reverse current flow from output to input. This makes the LT1529/LT1529-3.3/LT1529-5 ideal for backup power situations where the output is held high and the input is at ground or reversed. Under these conditions, only 16 μA will flow from the OUTPUT pin to ground. The devices are available in 5-lead TO-220 and 5-lead DD packages.

TYPICAL APPLICATION

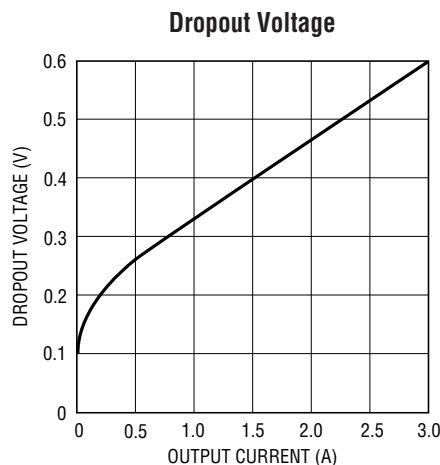
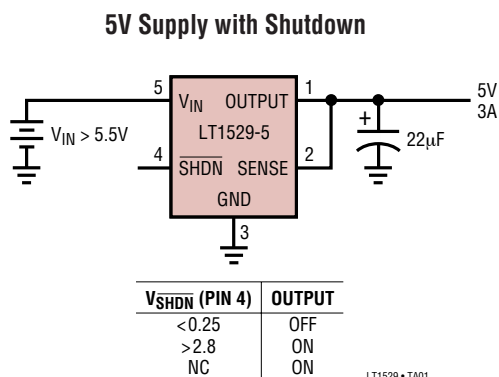

LT1529

LT1529-3.3/LT1529-5

ABSOLUTE MAXIMUM RATINGS (Note 1)

Input Voltage	$\pm 15V^*$	Output Short-Circuit Duration	Indefinite
OUTPUT Pin Reverse Current	10mA	Storage Temperature Range	$-65^{\circ}C$ to $150^{\circ}C$
SENSE Pin Current	10mA	Operating Junction Temperature Range	
ADJ Pin Current	10mA	Commercial	$0^{\circ}C$ to $125^{\circ}C$
SHDN Pin Input Voltage (Note 2)	$6.5V, -0.6V$	Industrial	$-45^{\circ}C$ to $125^{\circ}C$
SHDN Pin Input Current (Note 2)	5mA	Lead Temperature (Soldering, 10 sec)	$300^{\circ}C$

*For applications requiring input voltage ratings greater than 15V, contact the factory.

PACKAGE/ORDER INFORMATION

FRONT VIEW	ORDER PART NUMBER	FRONT VIEW	ORDER PART NUMBER
<p>Q PACKAGE 5-LEAD PLASTIC DD PAK</p> <p>*PIN 2 = SENSE FOR LT1529-3.3/LT1529-5 = ADJ FOR LT1529</p> <p>$T_{JMAX} = 125^{\circ}C, \theta_{JA} \approx 30^{\circ}C/W$</p>	LT1529CQ LT1529CQ-3.3 LT1529CQ-5 LT1529IQ LT1529IQ-3.3 LT1529IQ-5	<p>T PACKAGE 5-LEAD PLASTIC TO-220</p> <p>*PIN 2 = SENSE FOR LT1529-3.3/LT1529-5 = ADJ FOR LT1529</p> <p>$T_{JMAX} = 125^{\circ}C, \theta_{JA} \approx 50^{\circ}C/W$</p>	LT1529CT LT1529CT-3.3 LT1529CT-5 LT1529IT LT1529IT-3.3 LT1529IT-5

Consult LTC Marketing for parts specified with wider operating temperature ranges.

ELECTRICAL CHARACTERISTICS

The ● denotes specifications which apply over the operating temperature range, otherwise specifications are at $T_A = 25^{\circ}C$. (Note 3)

PARAMETER	CONDITIONS	MIN	TYP	MAX	UNITS
Regulated Output Voltage (Note 4)	LT1529-3.3 $V_{IN} = 3.8V, I_{OUT} = 1mA, T_J = 25^{\circ}C$ $4.3V < V_{IN} < 15V, 1mA < I_{OUT} < 3A$	● 3.250	3.300	3.350	V
		3.200	3.300	3.400	V
	LT1529-5 $V_{IN} = 5.5V, I_{OUT} = 1mA, T_J = 25^{\circ}C$ $6V < V_{IN} < 15V, 1mA < I_{OUT} < 3A$	● 4.925	5.000	5.075	V
		4.850	5.000	5.150	V
Line Regulation	LT1529-3.3 $\Delta V_{IN} = 3.8V$ to $15V, I_{OUT} = 1mA$	●	1.5	10	mV
	LT1529-5 $\Delta V_{IN} = 5.5V$ to $15V, I_{OUT} = 1mA$	●	1.5	10	mV
	LT1529 (Note 5) $\Delta V_{IN} = 4.3V$ to $15V, I_{OUT} = 1mA$	●	1.5	10	mV
Load Regulation	LT1529-3.3 $\Delta I_{LOAD} = 1mA$ to $3A, V_{IN} = 4.3V, T_J = 25^{\circ}C$ $\Delta I_{LOAD} = 1mA$ to $3A, V_{IN} = 4.3V$	●	5	20	mV
			12	30	mV
	LT1529-5 $\Delta I_{LOAD} = 1mA$ to $3A, V_{IN} = 6V, T_J = 25^{\circ}C$ $\Delta I_{LOAD} = 1mA$ to $3A, V_{IN} = 6V$	●	5	20	mV
			12	30	mV
Dropout Voltage (Note 6)	LT1529 (Note 5) $\Delta I_{LOAD} = 1mA$ to $3A, V_{IN} = 4.8V, T_J = 25^{\circ}C$ $\Delta I_{LOAD} = 1mA$ to $3A, V_{IN} = 4.8V$	●	5	20	mV
			12	30	mV
	$I_{LOAD} = 10mA, T_J = 25^{\circ}C$ $I_{LOAD} = 10mA$	●	110	180	mV
			250	mV	
	$I_{LOAD} = 100mA, T_J = 25^{\circ}C$ $I_{LOAD} = 100mA$	●	200	300	mV
				400	mV

152935fb

ELECTRICAL CHARACTERISTICS

The ● denotes specifications which apply over the operating temperature range, otherwise specifications are at $T_A = 25^\circ\text{C}$. (Note 3)

PARAMETER	CONDITIONS	MIN	TYP	MAX	UNITS
Dropout Voltage (Note 6)	$I_{\text{LOAD}} = 700\text{mA}$, $T_J = 25^\circ\text{C}$		320	430	mV
	$I_{\text{LOAD}} = 700\text{mA}$	●		550	mV
	$I_{\text{LOAD}} = 1.5\text{A}$, $T_J = 25^\circ\text{C}$		430	550	mV
	$I_{\text{LOAD}} = 1.5\text{A}$	●		700	mV
GND Pin Current (Note 7)	$I_{\text{LOAD}} = 3\text{A}$, $T_J = 25^\circ\text{C}$		600	750	mV
	$I_{\text{LOAD}} = 3\text{A}$	●		950	mV
	$I_{\text{LOAD}} = 0\text{mA}$, $T_J = 25^\circ\text{C}$		50	100	μA
	$I_{\text{LOAD}} = 0\text{mA}$, $T_J = 125^\circ\text{C}$ (Note 8)		400		μA
	$I_{\text{LOAD}} = 100\text{mA}$, $T_J = 25^\circ\text{C}$		0.6	1.0	mA
	$I_{\text{LOAD}} = 100\text{mA}$, $T_J = 125^\circ\text{C}$ (Note 8)		1.0		mA
ADJ Pin Bias Current (Notes 5, 9)	$I_{\text{LOAD}} = 700\text{mA}$	●	5.5	12	mA
	$I_{\text{LOAD}} = 1.5\text{A}$	●	20	40	mA
	$I_{\text{LOAD}} = 3\text{A}$	●	80	160	mA
	$T_J = 25^\circ\text{C}$		150	300	nA
	Shutdown Threshold	$V_{\text{OUT}} = \text{Off to On}$	●	1.20	2.8
	$V_{\text{OUT}} = \text{On to Off}$	●	0.25	0.75	V
$\overline{\text{SHDN}}$ Pin Current (Note 10)	$V_{\overline{\text{SHDN}}} = 0\text{V}$	●	4.5	10	μA
Quiescent Current in Shutdown (Note 11)	$V_{\text{IN}} = V_{\text{OUT}} (\text{Nominal}) + 1\text{V}$, $V_{\overline{\text{SHDN}}} = 0\text{V}$	●	15	30	μA
Ripple Rejection	$V_{\text{IN}} - V_{\text{OUT}} = 1\text{V}$ (Avg), $V_{\text{RIPPLE}} = 0.5\text{V}_{\text{P-P}}$, $f_{\text{RIPPLE}} = 120\text{Hz}$, $I_{\text{LOAD}} = 1.5\text{A}$		50	62	dB
Current Limit	$V_{\text{IN}} - V_{\text{OUT}} = 7\text{V}$, $T_J = 25^\circ\text{C}$			5	A
	$V_{\text{IN}} = V_{\text{OUT}} (\text{Nominal}) + 1.5\text{V}$, $\Delta V_{\text{OUT}} = -0.1\text{V}$	●	3.2	4.7	A
Input Reverse Leakage Current	$V_{\text{IN}} = -15\text{V}$, $V_{\text{OUT}} = 0\text{V}$	●		1.0	mA
Reverse Output Current (Note 12)	LT1529-3.3			16	μA
	LT1529-5	$V_{\text{OUT}} = 3.3\text{V}$, $V_{\text{IN}} = 0\text{V}$		16	μA
	LT1529 (Note 6)	$V_{\text{OUT}} = 5\text{V}$, $V_{\text{IN}} = 0\text{V}$		16	μA
		$V_{\text{OUT}} = 3.8\text{V}$, $V_{\text{IN}} = 0\text{V}$		16	μA

Note 1: Absolute Maximum Ratings are those values beyond which the life of a device may be impaired.

Note 2: The $\overline{\text{SHDN}}$ pin input voltage rating is required for a low impedance source. Internal protection devices connected to the SHDN pin will turn on and clamp the pin to approximately 7V or -0.6V . This range allows the use of 5V logic devices to drive the pin directly. For high impedance sources or logic running on supply voltages greater than 5.5V, the maximum current driven into the SHDN pin must be limited to less than 5mA.

Note 3: The device is tested under pulse load conditions such that $T_J = T_A$.

Note 4: Operating conditions are limited by maximum junction temperature. The regulated output voltage specification will not apply for all possible combinations of input voltage and output current. When operating at maximum input voltage, the output current range must be limited. When operating at maximum output current the input voltage range must be limited.

Note 5: The LT1529 is tested and specified with the ADJ pin connected to the OUTPUT pin.

Note 6: Dropout voltage is the minimum input/output voltage required to maintain regulation at the specified output current. In dropout the output voltage will be equal to $(V_{\text{IN}} - V_{\text{DROPOUT}})$.

Note 7: GND pin current is tested with $V_{\text{IN}} = V_{\text{OUT}}$ (nominal) and a current source load. This means that the device is tested while operating in its dropout region. This is the worst-case GND pin current. The GND pin current will decrease slightly at higher input voltages.

Note 8: GND pin current will rise at $T_J > 75^\circ\text{C}$. This is due to internal circuitry designed to compensate for leakage currents in the output transistor at high temperatures. This allows quiescent current to be minimized at lower temperatures, yet maintain output regulation at high temperatures with light loads. See quiescent current curve in typical performance characteristics.

Note 9: ADJ pin bias current flows into the ADJ pin.

Note 10: $\overline{\text{SHDN}}$ pin current at $V_{\overline{\text{SHDN}}} = 0\text{V}$ flows out of the $\overline{\text{SHDN}}$ pin.

Note 11: Quiescent current in shutdown is equal to the sum total of the $\overline{\text{SHDN}}$ pin current (5 μA) and the GND pin current (10 μA).

Note 12: Reverse output current is tested with the V_{IN} pin grounded and the OUTPUT pin forced to the rated output voltage. This current flows into the OUTPUT pin and out of the GND pin.

TYPICAL PERFORMANCE CHARACTERISTICS

Guaranteed Dropout Voltage

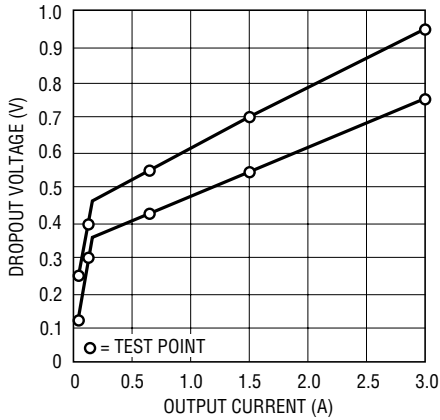

LT1529 • G01

Dropout Voltage

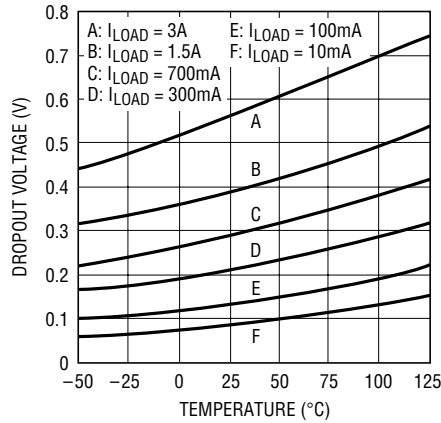

LT1529 • G02

Quiescent Current

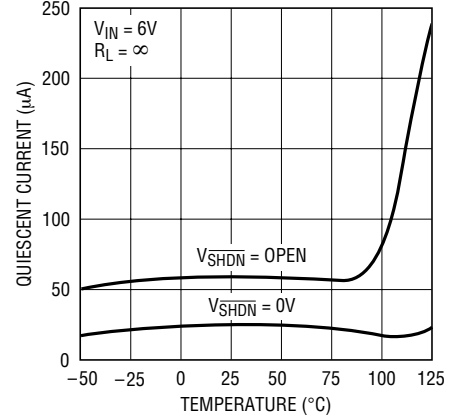

LT1529 • G03

**LT1529-3.3
 Quiescent Current**

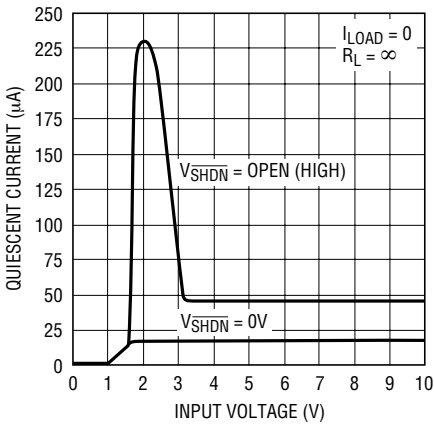

LT1529 • G04

**LT1529-5
 Quiescent Current**

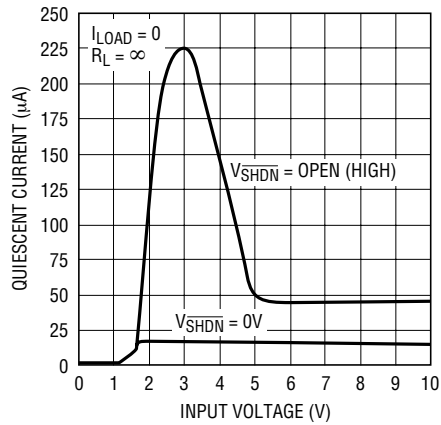

LT1529 • G05

**LT1529
 Quiescent Current**

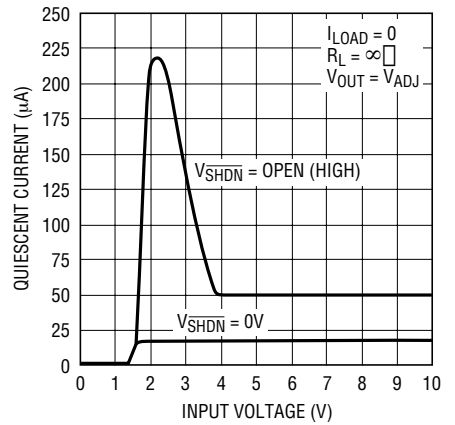

LT1529 • G06

**LT1529-3.3
 Output Voltage**

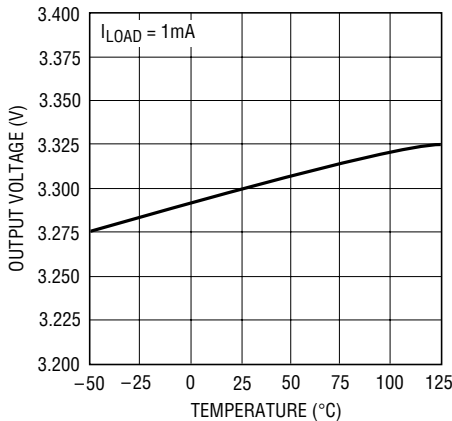

LT1529 • G07

**LT1529-5
 Output Voltage**

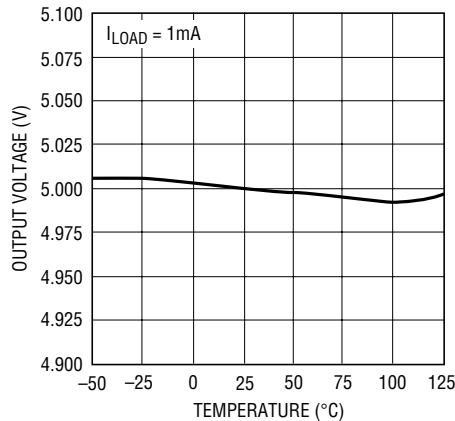

LT1529 • G08

**LT1529
 ADJ Pin Voltage**

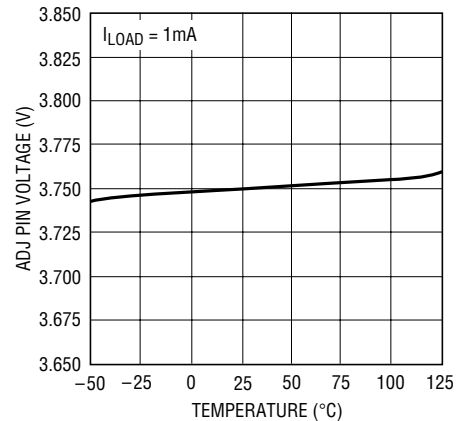

LT1529 • G09

TYPICAL PERFORMANCE CHARACTERISTICS

**LT1529-3.3
GND Pin Current**

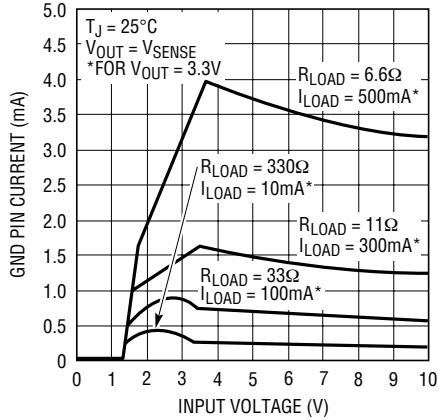

LT1529 • G10

**LT1529-5
GND Pin Current**

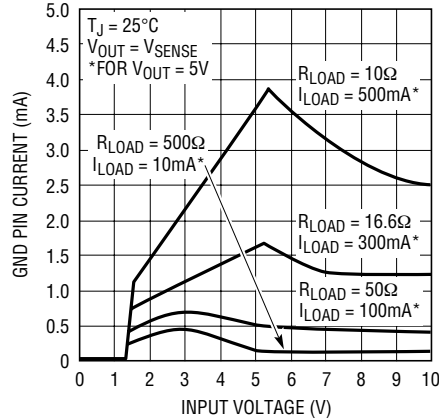

LT1529 • G11

**LT1529
GND Pin Current**

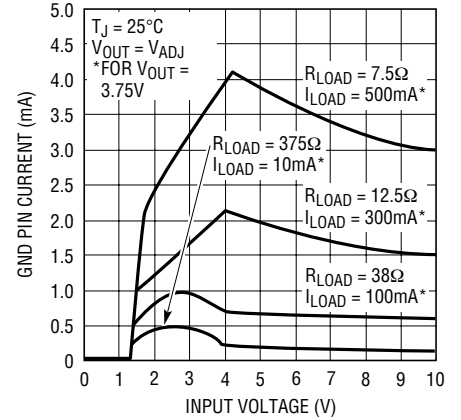

LT1529 • G12

**LT1529-3.3
GND Pin Current**

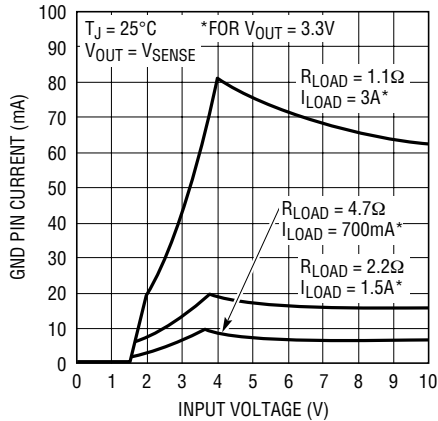

LT1529 • G13

**LT1529-5
GND Pin Current**

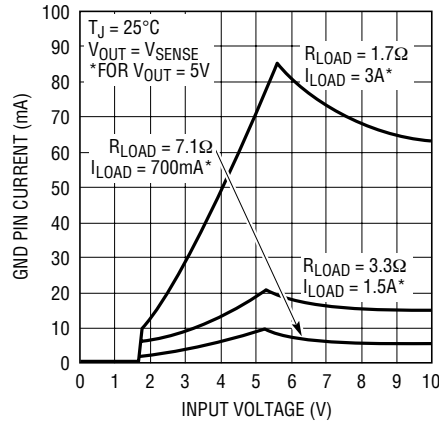

LT1529 • G14

**LT1529
GND Pin Current**

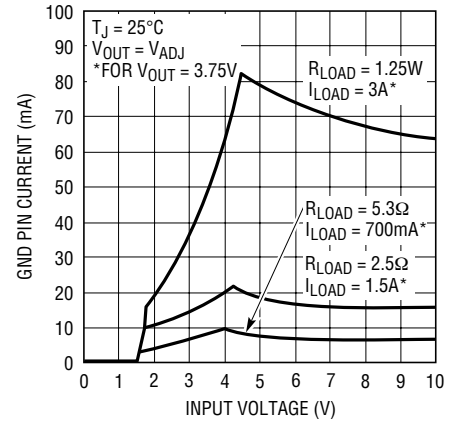

LT1529 • G15

GND Pin Current

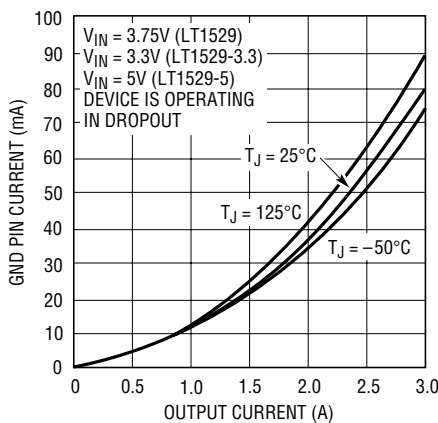

LT1529 • G16

**SHDN Pin Threshold
(On-to-Off)**

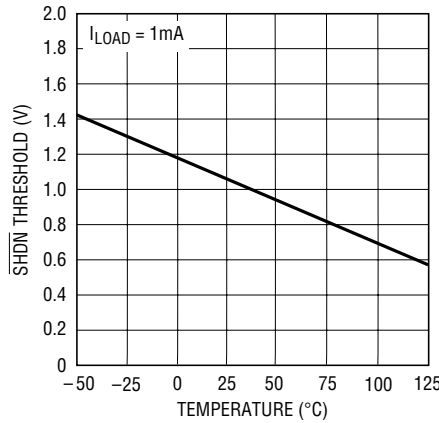

LT1529 • G17

**SHDN Pin Threshold
(Off-to-On)**

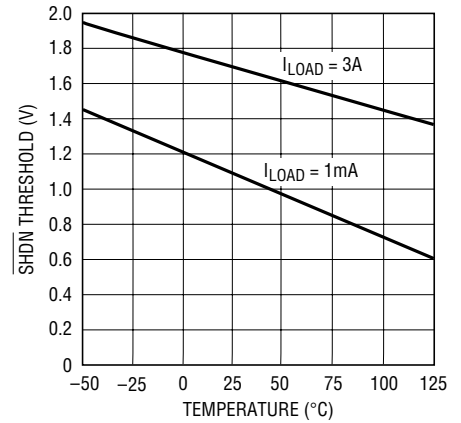

LT1529 • G18

TYPICAL PERFORMANCE CHARACTERISTICS

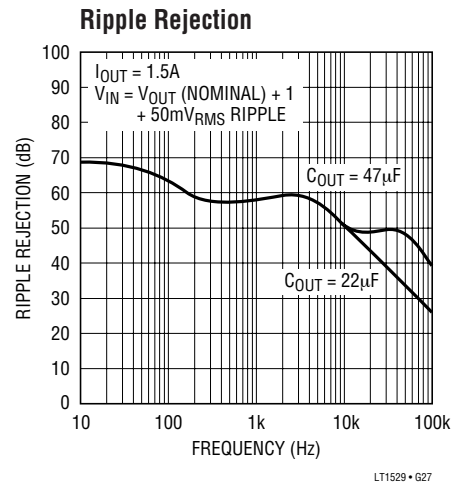
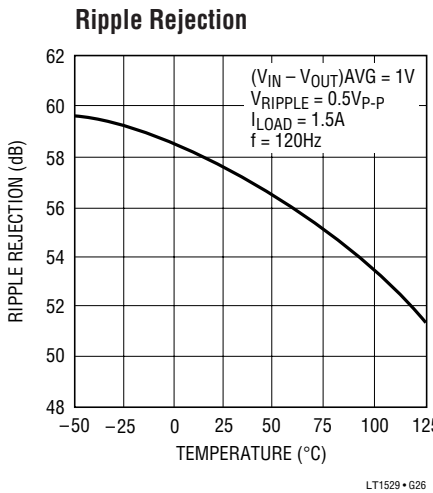
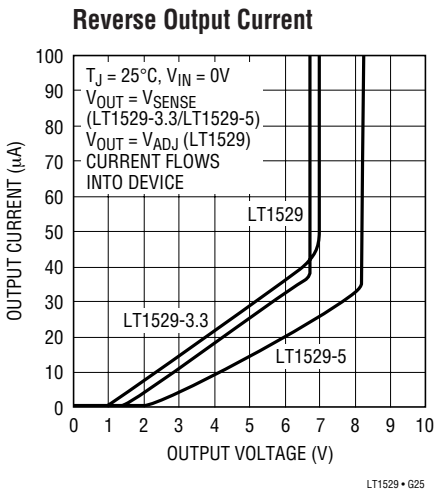
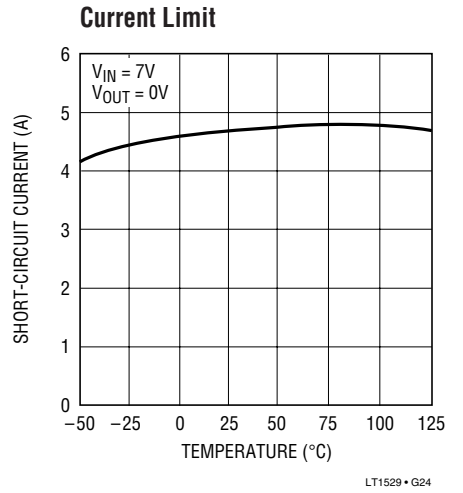
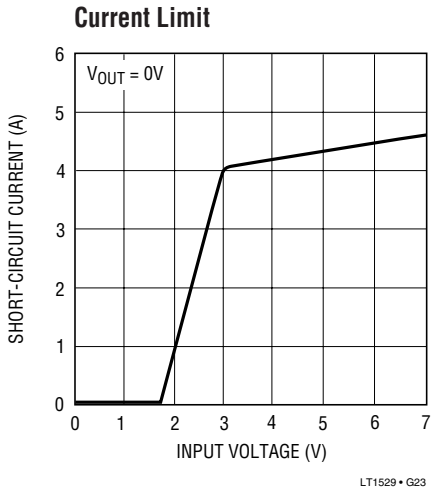
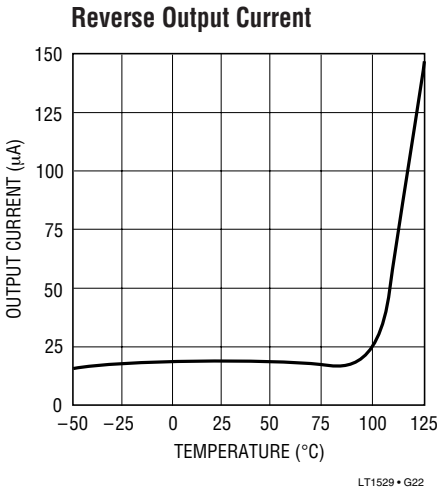
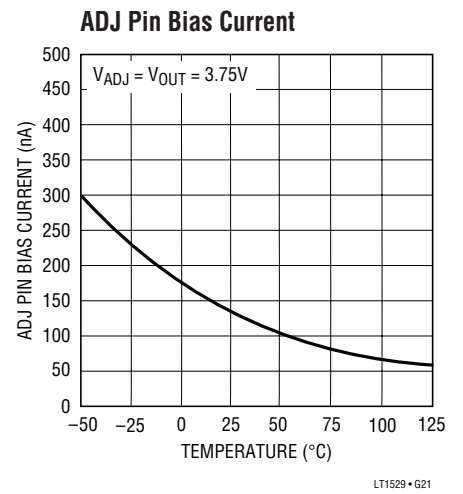
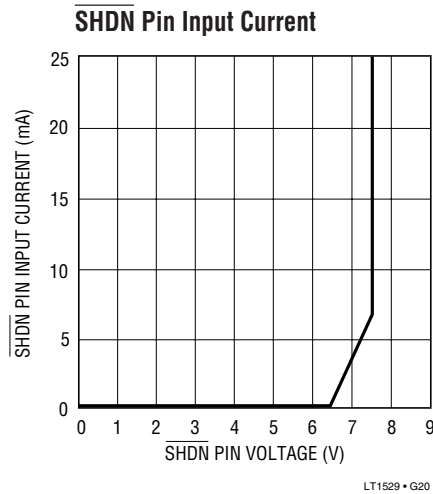
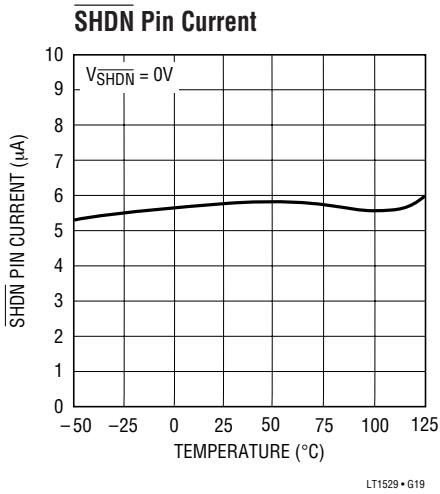

TYPICAL PERFORMANCE CHARACTERISTICS

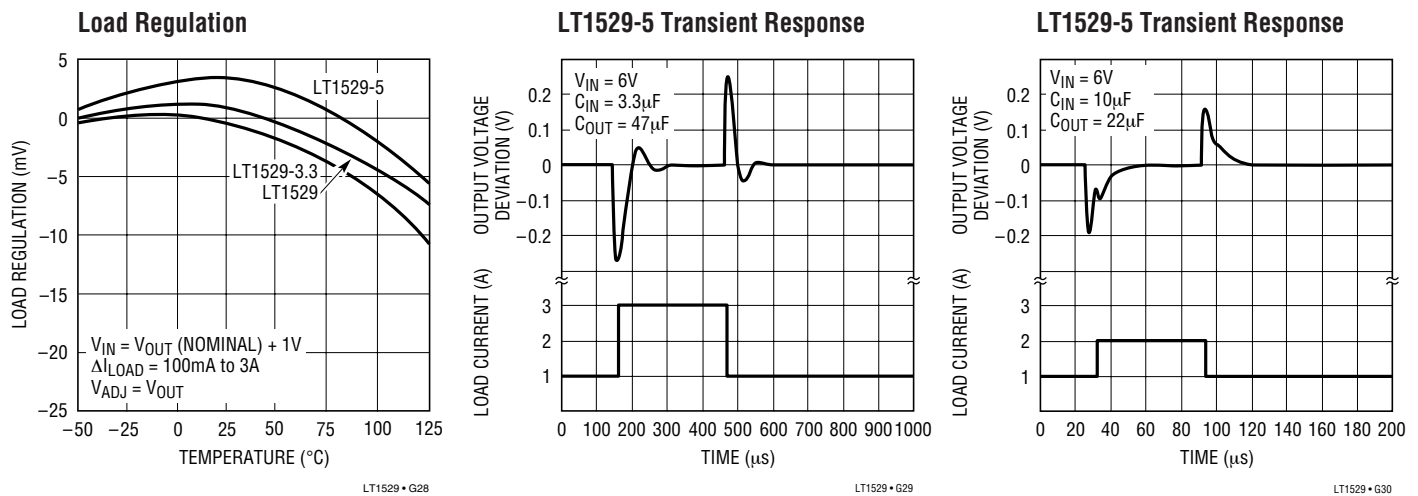

PIN FUNCTIONS

OUTPUT (Pin 1): OUTPUT Pin. The OUTPUT pin supplies power to the load. A minimum output capacitor of $22\mu\text{F}$ is required to prevent oscillations. Larger values will be required to optimize transient response for large load current deltas. See the Applications Information section for further information on output capacitance and reverse output characteristics.

SENSE (Pin 2): SENSE Pin. For fixed voltage versions of the LT1529 (LT1529-3.3, LT1529-5) the SENSE pin is the input to the error amplifier. Optimum regulation will be obtained at the point where the SENSE pin is connected to the output pin. For most applications the SENSE pin is connected directly to the OUTPUT pin at the regulator. In critical applications small voltage drops caused by the resistance (R_P) of PC traces between the regulator and the load, which would normally degrade regulation, may be eliminated by connecting the SENSE pin to the OUTPUT pin at the load as shown in Figure 1 (Kelvin Sense Connection). Note that the voltage drop across the external PC traces will add to the dropout voltage of the regulator. The SENSE pin bias current is $15\mu\text{A}$ at the nominal regulated output voltage. This pin is internally clamped to -0.6V (one V_{BE}).

ADJ (Pin 2): Adjust Pin. For the LT1529 (adjustable version) the ADJ pin is the input to the error amplifier. This

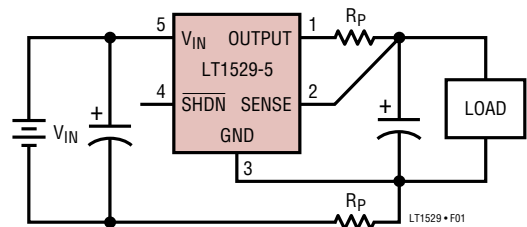

Figure 1. Kelvin Sense Connection

pin is internally clamped to 6V and -0.6V (one V_{BE}). This pin has a bias current of 150nA which flows into the pin. See Bias Current curve in the Typical Performance Characteristics. The ADJ pin reference voltage is equal to 3.75V referenced to ground.

SHDN (Pin 4): Shutdown Pin. This pin is used to put the device into shutdown. In shutdown the output of the device is turned off. This pin is active low. The device will be shut down if the SHDN pin is actively pulled low. The SHDN pin current with the pin pulled to ground will be $6\mu\text{A}$. The SHDN pin is internally clamped to 7V and -0.6V (one V_{BE}). This allows the SHDN pin to be driven directly by 5V logic or by open-collector logic with a pull-up resistor. The pull-up resistor is only required to supply the leakage current of the open-collector gate, normally several microamperes. Pull-up current must be limited to a maximum of 5mA . A curve of SHDN pin input current as a

PIN FUNCTIONS

function of voltage appears in the Typical Performance Characteristics. If the SHDN pin is not used it can be left open circuit. The device will be active, output on, if the SHDN pin is not connected.

V_{IN} (Pin 5): Input Pin. Power is supplied to the device through the V_{IN} pin. The V_{IN} pin should be bypassed to ground if the device is more than six inches away from the main input filter capacitor. In general, the output impedance of a battery rises with frequency so it is advisable to

include a bypass capacitor in battery-powered circuits. A bypass capacitor in the range of 1μF to 10μF is sufficient. The LT1529 is designed to withstand reverse voltages on the V_{IN} pin with respect to ground and OUTPUT pin. In the case of a reversed input, which can happen if a battery is plugged in backwards, the LT1529 will act as if there is a diode in series with its input. There will be no reverse current flow into the LT1529 and no reverse voltage will appear at the load. The device will protect both itself and the load.

APPLICATIONS INFORMATION

The LT1529 is a 3A low dropout regulator with micropower quiescent current and shutdown capable of supplying 3A of output current at a dropout voltage of 0.6V. The device operates with very low quiescent current (50μA). In shutdown the quiescent current drops to only 16μA. In addition to the low quiescent current the LT1529 incorporates several protection features which make it ideal for use in battery-powered systems. The device is protected against reverse input voltages. In battery backup applications where the output can be held up by a backup battery when the input is pulled to ground, the LT1529 acts like it has a diode in series with its output and prevents reverse current flow.

Adjustable Operation

The adjustable version of the LT1529 has an output voltage range of 3.75V to 14V. The output voltage is set by the ratio of two external resistors as shown in Figure 2. The device servos the output voltage to maintain the voltage at the ADJ pin at 3.75V. The current in R1 is then equal to 3.75V/R1. The current in R2 is equal to the sum of the current in R1 and the ADJ pin bias current. The ADJ pin bias current, 150nA at 25°C, flows through R2 into the ADJ pin. The output voltage can be calculated according to the formula in Figure 2. The value of R1 should be less than 400k to minimize errors in the output voltage caused by the ADJ pin bias current. Note that in shutdown the output is turned off and the divider current will be zero. Curves of ADJ Pin Voltage vs Temperature and ADJ Pin

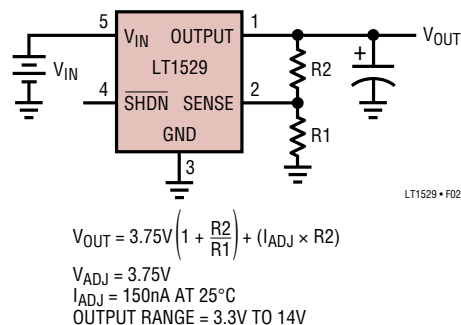

Figure 2. Adjustable Operation

Bias Current vs Temperature appear in the Typical Performance Characteristics. The reference voltage at the ADJ pin has a positive temperature coefficient of approximately 15ppm/°C. The ADJ pin bias current has a negative temperature coefficient. These effects will tend to cancel each other.

The adjustable device is specified with the ADJ pin tied to the OUTPUT pin. This sets the output voltage to 3.75V. Specifications for output voltage greater than 3.75V will be proportional to the ratio of the desired output voltage to 3.75V ($V_{OUT}/3.75V$). For example: load regulation for an output current change of 1mA to 3A is -0.5mV typical at $V_{OUT} = 3.75V$. At $V_{OUT} = 12V$, load regulation would be:

$$\left(\frac{12V}{3.75V} \right) (-0.5mV) = (-1.6mV)$$

APPLICATIONS INFORMATION

Thermal Considerations

The power handling capability of the device will be limited by the maximum rated junction temperature (125°C). The power dissipated by the device will be made up of two components:

1. Output current multiplied by the input/output voltage differential: $I_{OUT} \cdot (V_{IN} - V_{OUT})$, and
2. Ground pin current multiplied by the input voltage: $I_{GND} \cdot V_{IN}$.

The GND pin current can be found by examining the GND Pin Current curves in the Typical Performance Characteristics. Power dissipation will be equal to the sum of the two components listed above.

The LT1529 series regulators have internal thermal limiting designed to protect the device during overload conditions. For continuous normal load conditions the maximum junction temperature rating of 125°C must not be exceeded. It is important to give careful consideration to all sources of thermal resistance from junction to ambient. Additional heat sources mounted nearby must also be considered.

For surface mount devices heat sinking is accomplished by using the heat spreading capabilities of the PC board and its copper traces. Experiments have shown that the heat spreading copper layer does not need to be electrically connected to the tab of the device. The PC material can be very effective at transmitting heat between the pad area, attached to the tab of the device, and a ground or power plane layer either inside or on the opposite side of the board. Although the actual thermal resistance of the PC material is high, the length/area ratio of the thermal resistor between layers is small. Copper board stiffeners and plated through-holes can also be used to spread the heat generated by power devices.

The following tables list thermal resistances for each package. For the TO-220 package, thermal resistance is given for junction-to-case only since this package is usually mounted to a heat sink. Measured values of thermal resistance for several different copper areas are listed for the DD package. All measurements were taken in still air on 3/32" FR-4 board with 1-oz copper. This data can be used as a rough guideline in estimating thermal resis-

tance. The thermal resistance for each application will be affected by thermal interactions with other components as well as board size and shape. Some experimentation will be necessary to determine the actual value.

Table 1. Q Package, 5-Lead DD

COPPER AREA		BOARD AREA	THERMAL RESISTANCE (JUNCTION-TO-AMBIENT)
TOPSIDE*	BACKSIDE		
2500 sq. mm	2500 sq. mm	2500 sq. mm	23°C/W
1000 sq. mm	2500 sq. mm	2500 sq. mm	25°C/W
125 sq. mm	2500 sq. mm	2500 sq. mm	33°C/W

* Device is mounted on topside.

T Package, 5-Lead TO-220

Thermal Resistance (Junction-to-Case) = 2.5°C/W

Calculating Junction Temperature

Example: Given an output voltage of 3.3V, an input voltage range of 4.5V to 5.5V, an output current range of 0mA to 500mA, and a maximum ambient temperature of 50°C, what will the maximum junction temperature be?

The power dissipated by the device will be equal to:

$$I_{OUT(MAX)} \cdot (V_{IN(MAX)} - V_{OUT}) + (I_{GND} \cdot V_{IN(MAX)})$$

where, $I_{OUT(MAX)} = 500\text{mA}$

$$V_{IN(MAX)} = 5.5\text{V}$$

$$I_{GND} \text{ at } (I_{OUT} = 500\text{mA}, V_{IN} = 5.5\text{V}) = 3.6\text{mA}$$

$$\text{so, } P = 500\text{mA} \cdot (5.5\text{V} - 3.3\text{V}) + (3.6\text{mA} \cdot 5.5\text{V}) = 1.12\text{W}$$

If we use a DD package, then the thermal resistance will be in the range of 23°C/W to 33°C/W depending on copper area. So the junction temperature rise above ambient will be approximately equal to:

$$1.12\text{W} \cdot 28^\circ\text{C/W} = 31.4^\circ\text{C}$$

The maximum junction temperature will then be equal to the maximum junction temperature rise above ambient plus the maximum ambient temperature or:

$$T_{JMAX} = 50^\circ\text{C} + 31.4^\circ\text{C} = 81.4^\circ\text{C}$$

Output Capacitance and Transient Performance

The LT1529 is designed to be stable with a wide range of output capacitors. The minimum recommended value is 22µF with an ESR of 0.2Ω or less. The LT1529 is a

152935fb

APPLICATIONS INFORMATION

micropower device and output transient response will be a function of output capacitance. See the Transient Response curves in the Typical Performance Characteristics. Larger values of output capacitance will decrease the peak deviations and provide improved output transient response for larger load current deltas. Bypass capacitors, used to decouple individual components powered by the LT1529, will increase the effective value of the output capacitor.

Protection Features

The LT1529 incorporates several protection features which make it ideal for use in battery-powered circuits. In addition to the normal protection features associated with monolithic regulators, such as current limiting and thermal limiting, the device is protected against reverse input voltages, and reverse voltages from output to input.

Current limit protection and thermal overload protection are intended to protect the device against current overload conditions at the output of the device. For normal operation, the junction temperature should not exceed 125°C.

The input of the device will withstand reverse voltages of 15V. Current flow into the device will be limited to less than 1mA (typically less than 100µA) and no negative voltage will appear at the output. The device will protect both itself and the load. This provides protection against batteries that can be plugged in backwards.

For fixed voltage versions of the device, the SENSE pin is internally clamped to one diode drop below ground. For the adjustable version of the device, the OUTPUT pin is internally clamped at one diode drop below ground. If the

OUTPUT pin of an adjustable device, or the SENSE pin of a fixed voltage device, is pulled below ground, with the input open or grounded, current must be limited to less than 5mA.

In circuits where a backup battery is required, several different input/output conditions can occur. The output voltage may be held up while the input is either pulled to ground, pulled to some intermediate voltage, or is left open circuit. Current flow back into the output will vary depending on the conditions. Many battery-powered circuits incorporate some form of power management. The following information will help optimize battery life. Table 2 summarizes the following information.

The reverse output current will follow the curve in Figure 3 when the input is pulled to ground. This current flows through the device to ground. The state of the SHDN pin will have no effect on output current when the V_{IN} pin is pulled to ground.

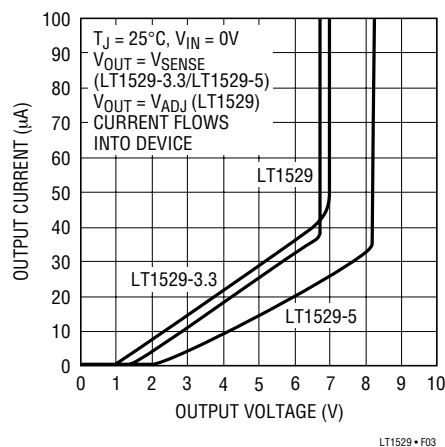

Figure 3. Reverse Output Current

Table 2. Fault Conditions

V_{IN} PIN	SHDN PIN	OUTPUT/SENSE PINS	
$<V_{OUT}$ (Nominal)	Open (High)	Forced to V_{OUT} (Nominal)	Reverse Output Current $\approx 15\mu A$ (See Figure 3), Input Current $\approx 1\mu A$ (See Figure 4)
$<V_{OUT}$ (Nominal)	Grounded	Forced to V_{OUT} (Nominal)	Reverse Output Current $\approx 15\mu A$ (See Figure 3), Input Current $\approx 1\mu A$ (See Figure 4)
Open	Open (High)	$> 1V$	Reverse Output Current $\approx 15\mu A$ Peak (See Figure 3)
Open	Grounded	$> 1V$	Reverse Output Current $\approx 15\mu A$ (See Figure 3)
$\leq 0.8V$	Open (High)	$\leq 0V$	Output Current = 0
$\leq 0.8V$	Grounded	$\leq 0V$	Output Current = 0
$> 1.5V$	Open (High)	$\leq 0V$	Output Current = Short-Circuit Current
$-15V < V_{IN} < 15V$	Grounded	$\leq 0V$	Output Current = 0

APPLICATIONS INFORMATION

In some applications it may be necessary to leave the input to the LT1529 unconnected when the output is held high. This can happen when the LT1529 is powered from a rectified AC source. If the AC source is removed, then the input of the LT1529 is effectively left floating. The reverse output current also follows the curve in Figure 3 if the V_{IN} pin is left open. The state of the SHDN pin will have no effect on the reverse output current when the V_{IN} pin is floating.

When the input of the LT1529 is forced to a voltage below its nominal output voltage and its output is held high, the output current will follow the curve shown in Figure 3. This can happen if the input of the LT1529 is connected to a discharged (low voltage) battery and the output is held up by either a backup battery or by a second regulator circuit. When the V_{IN} pin is forced below the OUTPUT pin or the OUTPUT pin is pulled above the V_{IN} pin, the input current

will typically drop to less than $2\mu\text{A}$ (see Figure 4). The state of the SHDN pin will have no effect on the reverse output current when the output is pulled above the input.

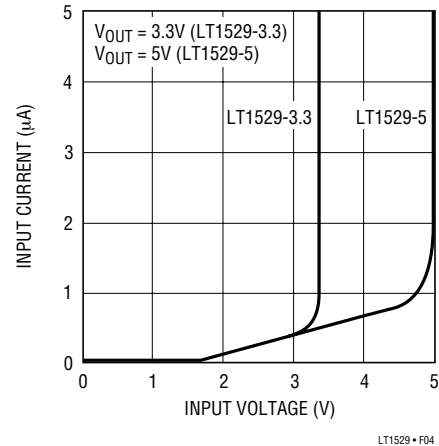
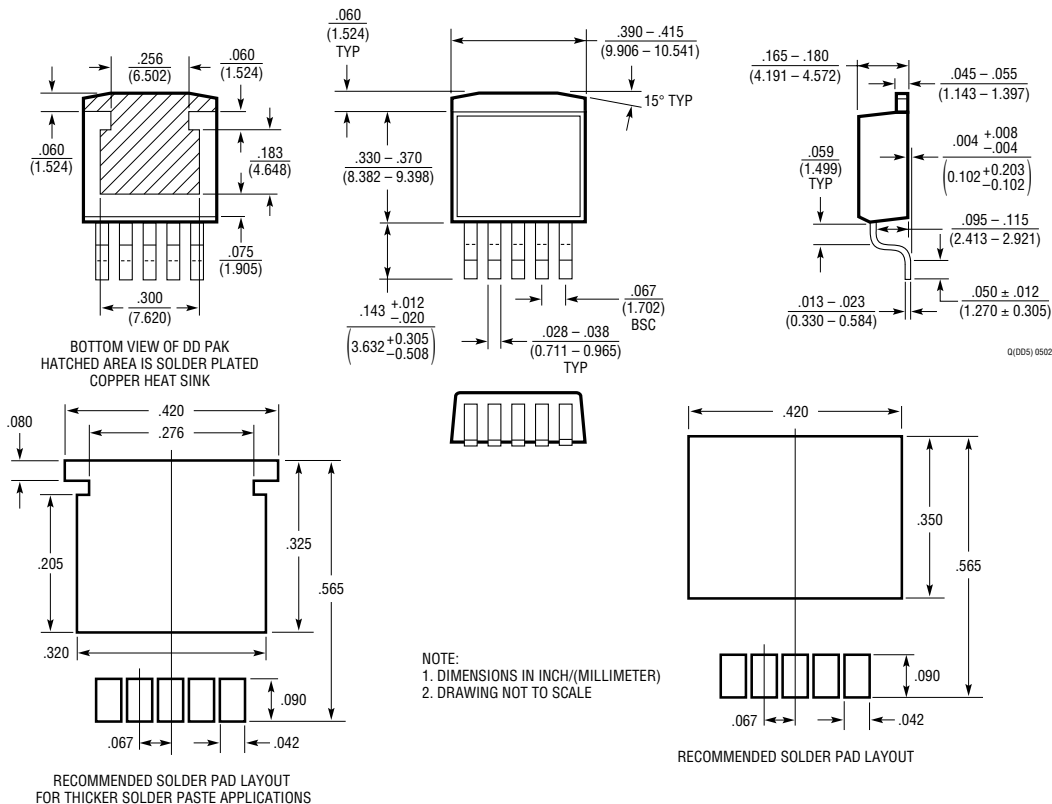

Figure 4. Input Current

PACKAGE DESCRIPTION

Q Package 5-Lead Plastic DD Pak (LTC DWG # 05-08-1461)



PACKAGE DESCRIPTION

T Package
5-Lead Plastic TO-220 (Standard)
 (LTC DWG # 05-08-1421)

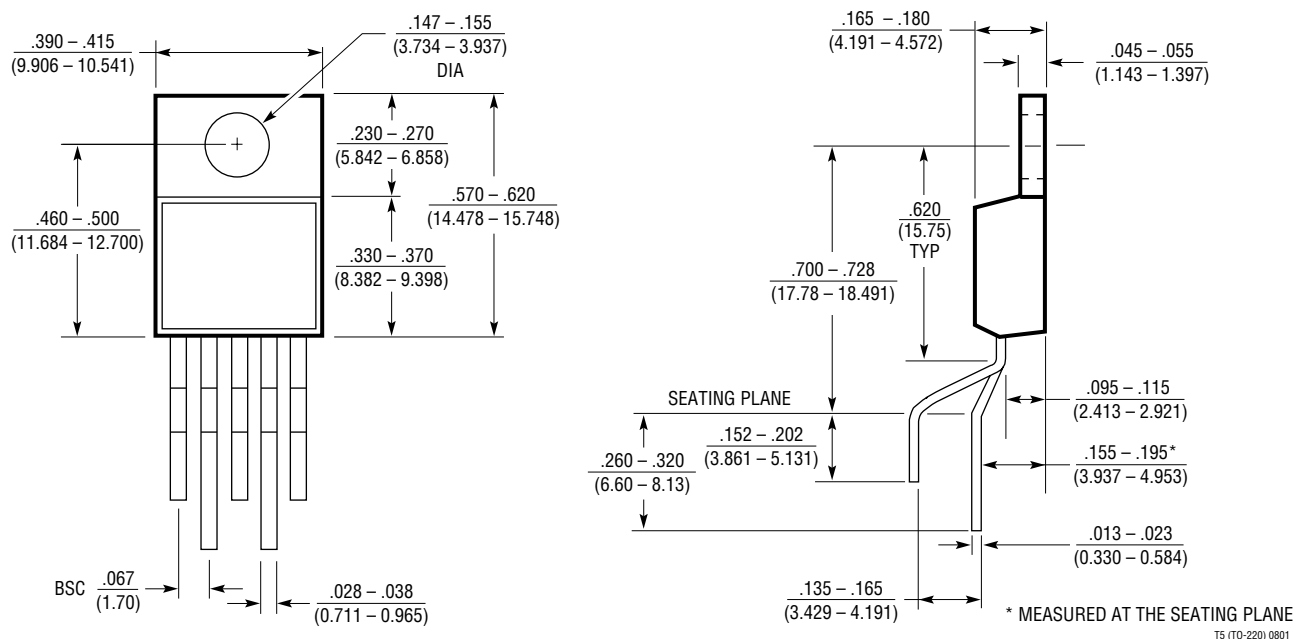

RELATED PARTS

PART NUMBER	DESCRIPTION	COMMENTS
LT1120A	125mA Low Dropout Regulator with 20 μ A I _Q	Includes 2.5V Reference and Comparator
LTC [®] 1174	High Efficiency 425mA Step-Down DC/DC Converter	Over 90% Efficiency, Includes Comparator
LT1303	Micropower Step-Up DC/DC Converter	Includes Comparator, Good for EL Displays
LT1376	500kHz 1.25A Step-Down DC/DC Converter	Uses Extremely Small External Components
LT1521	300 μ A Low Dropout Regulator with 15 μ A I _Q	Lowest I _Q Low Dropout Regulator

Looking for pricing, stock, or lifecycle information?

Click below to explore more details on WIN SOURCE:

- ⊖ [View LT1529IQ-3.3#TRPBF on WIN SOURCE](#)
- ⊖ [Analog Devices Inc. Information](#)

Optimize Your Supply Chain with WIN SOURCE Solutions

- ✓ Global Sourcing Solution
- ✓ Obsolete Management
- ✓ Cost Control Management
- ✓ Shortage Management
- ✓ Alternative Solution
- ✓ Excess Inventory Management