



**THE DATASHEET OF
LT1587CT-3.45#PBF**



7A, 4.6A, 3A Low Dropout Fast Response Positive Regulators Adjustable and Fixed

FEATURES

- Fast Transient Response
- Guaranteed Dropout Voltage at Multiple Currents
- Load Regulation: 0.05% Typical
- Trimmed Current Limit
- On-Chip Thermal Limiting
- Standard 3-Pin Power Package

APPLICATIONS

- Pentium™ Processor Supplies
- PowerPC™ Supplies
- Other 2.5V to 3.6V Microprocessor Supplies
- Low Voltage Logic Supplies
- Battery-Powered Circuitry
- Post Regulator for Switching Supply

LT1585/7CM, LT1584/5/7CT	Adjustable
LT1585/7CM-3.3, LT1584/5/7CT-3.3	3.3V Fixed
LT1585CM-3.38, LT1584/5CT-3.38	3.38V Fixed
LT1585/7CM-3.45, LT1584/5/7CT-3.45	3.45V Fixed
LT1585/7CM-3.6, LT1584/5/7CT-3.6	3.6V Fixed

DESCRIPTION

The LT[®]1584/LT1585/LT1587 are low dropout three-terminal regulators with 7A, 4.6A and 3A output current capability, respectively. Design has been optimized for low voltage applications where transient response and minimum input voltage are critical. Similar to the LT1083/4/5 family, it has lower dropout voltage and faster transient response. These improvements make it ideal for low voltage microprocessor applications requiring a regulated 2.5V to 3.6V output with an input supply below 7V.

Current limit is trimmed to ensure specified output current and controlled short-circuit current. On-chip thermal limiting provides protection against any combination of overload that would create excessive junction temperatures.

The LT1585/LT1587 are available in both the through-hole and surface mount versions of the industry standard 3-pin TO-220 power package. The LT1584 is available in the through-hole 3-pin TO-220 power package.

LT, LTC and LT are registered trademarks of Linear Technology Corporation.
 Pentium is a trademark of Intel Corporation. PowerPC is a trademark of IBM Corporation.

TYPICAL APPLICATION

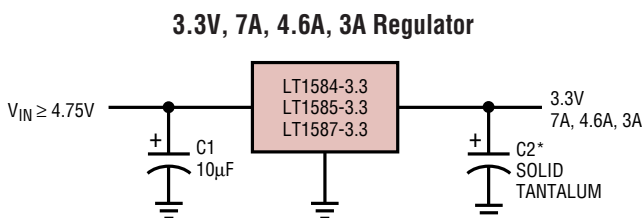

* REQUIRED FOR STABILITY
 LT1584: C2 = 22µF,
 LT1585/LT1587: C2 = 10µF

1585 TA01

NOTE: MICROPROCESSOR APPLICATIONS WITH LOAD TRANSIENTS OF 3.8A REQUIRE OUTPUT DECOUPLING CAPACITANCE > 1300µF ON FIXED VOLTAGE PARTS TO ACHIEVE < 50mV OF DEVIATION FROM NOMINAL OUTPUT. CONSULT FACTORY FOR DETAILS

Dropout Voltage vs Output Current

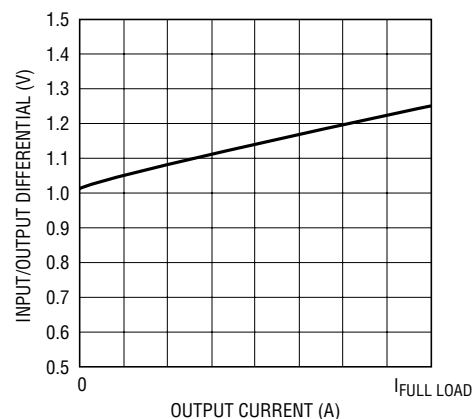

1585 TA02

158457a

LT1584/LT1585/LT1587

ABSOLUTE MAXIMUM RATINGS

(Note 1)

V_{IN} 7V
 Operating Junction Temperature Range
 C-Grade
 Control Section 0°C to 125°C
 Power Transistor 0°C to 150°C
 I-Grade
 Control Section -40°C to 125°C
 Power Transistor -40°C to 150°C

Storage Temperature Range -65°C to 150°C
 Lead Temperature (Soldering, 10 sec) 300°C

PRECONDITIONING

100% Thermal Limit Functional Test

PACKAGE/ORDER INFORMATION

 <p>M PACKAGE 3-LEAD PLASTIC DD $\theta_{JA} = 30^{\circ}\text{C/W}^*$</p>	<p>ORDER PART NUMBER</p> <p>LT1585CM LT1587CM</p>	 <p>T PACKAGE 3-LEAD PLASTIC TO-220 $\theta_{JA} = 50^{\circ}\text{C/W}$</p>	<p>ORDER PART NUMBER</p> <p>LT1584CT LT1585CT LT1587CT</p>
 <p>M PACKAGE 3-LEAD PLASTIC DD $\theta_{JA} = 30^{\circ}\text{C/W}^*$</p>	<p>LT1585CM-3.3 LT1585CM-3.38 LT1585CM-3.45 LT1585CM-3.6 LT1587CM-3.3 LT1587CM-3.45 LT1587CM-3.6</p>	 <p>T PACKAGE 3-LEAD PLASTIC TO-220 $\theta_{JA} = 50^{\circ}\text{C/W}$</p>	<p>LT1584CT-3.3 LT1584IT-3.3 LT1585CT-3.3 LT1587CT-3.3 LT1584CT-3.38 LT1585CT-3.38 LT1584CT-3.45 LT1585CT-3.45 LT1587CT-3.45 LT1584CT-3.6 LT1585CT-3.6 LT1587CT-3.6</p>

* With package soldered to 0.5 square inch copper area over backside ground plane or internal power plane. θ_{JA} can vary from 20°C/W to >40°C/W with other mounting techniques.

Consult LTC Marketing for parts specified with wider operating temperature ranges.

ELECTRICAL CHARACTERISTICS The ● denotes the specifications which apply over the full operating temperature range, otherwise specifications are at $T_A = 25^\circ\text{C}$.

PARAMETER	CONDITIONS	MIN	TYP	MAX	UNITS		
Reference Voltage	LT1584 LT1585 LT1587	$1.5\text{V} \leq (V_{\text{IN}} - V_{\text{OUT}}) \leq 3\text{V}, 10\text{mA} \leq I_{\text{OUT}} \leq 7\text{A}$ $1.5\text{V} \leq (V_{\text{IN}} - V_{\text{OUT}}) \leq 5.75\text{V}, 10\text{mA} \leq I_{\text{OUT}} \leq 4.6\text{A}, T_J \geq 25^\circ\text{C}$ $1.5\text{V} \leq (V_{\text{IN}} - V_{\text{OUT}}) \leq 5.75\text{V}, 10\text{mA} \leq I_{\text{OUT}} \leq 4\text{A}, T_J < 25^\circ\text{C}$ $1.5\text{V} \leq (V_{\text{IN}} - V_{\text{OUT}}) \leq 5.75\text{V}, 10\text{mA} \leq I_{\text{OUT}} \leq 3\text{A}$	●	1.225 (-2%)	1.250	1.275 (+2%)	V
Output Voltage	LT1584-3.3 LT1585-3.3 LT1587-3.3 LT1584-3.38 LT1585-3.38 LT1584-3.45 LT1585-3.45 LT1587-3.45 LT1584-3.6 LT1584-3.6 LT1584-3.6 LT1584-3.6 LT1585/7-3.6 LT1585/7-3.6 LT1585-3.6 LT1585-3.6	$4.75\text{V} \leq V_{\text{IN}} \leq 6.3\text{V}, 0\text{mA} \leq I_{\text{OUT}} \leq 7\text{A}$ $4.75\text{V} \leq V_{\text{IN}} \leq 7\text{V}, 0\text{mA} \leq I_{\text{OUT}} \leq 4.6\text{A}, T_J \geq 25^\circ\text{C}$ $4.75\text{V} \leq V_{\text{IN}} \leq 7\text{V}, 0\text{mA} \leq I_{\text{OUT}} \leq 4\text{A}, T_J < 25^\circ\text{C}$ $4.75\text{V} \leq V_{\text{IN}} \leq 7\text{V}, 0\text{mA} \leq I_{\text{OUT}} \leq 3\text{A}$ $4.75\text{V} \leq V_{\text{IN}} \leq 6.38\text{V}, 0\text{mA} \leq I_{\text{OUT}} \leq 7\text{A}$ $4.75\text{V} \leq V_{\text{IN}} \leq 7\text{V}, 0\text{mA} \leq I_{\text{OUT}} \leq 4\text{A}$ $4.75\text{V} \leq V_{\text{IN}} \leq 6.45\text{V}, 0\text{mA} \leq I_{\text{OUT}} \leq 7\text{A}$ $4.75\text{V} \leq V_{\text{IN}} \leq 7\text{V}, 0\text{mA} \leq I_{\text{OUT}} \leq 4\text{A}$ $4.75\text{V} \leq V_{\text{IN}} \leq 7\text{V}, 0\text{mA} \leq I_{\text{OUT}} \leq 3\text{A}$ $4.75\text{V} \leq V_{\text{IN}} \leq 7\text{V}, 0\text{mA} \leq I_{\text{OUT}} \leq 6\text{A}$ $4.80\text{V} \leq V_{\text{IN}} \leq 7\text{V}, 0\text{mA} \leq I_{\text{OUT}} \leq 6\text{A}$ $4.80\text{V} \leq V_{\text{IN}} \leq 6.6\text{V}, 0\text{mA} \leq I_{\text{OUT}} \leq 7\text{A}$ $4.85\text{V} \leq V_{\text{IN}} \leq 6.6\text{V}, 0\text{mA} \leq I_{\text{OUT}} \leq 7\text{A}$ $4.75\text{V} \leq V_{\text{IN}} \leq 7\text{V}, 0\text{mA} \leq I_{\text{OUT}} \leq 3\text{A}$ $4.80\text{V} \leq V_{\text{IN}} \leq 7\text{V}, 0\text{mA} \leq I_{\text{OUT}} \leq 3\text{A}$ $4.80\text{V} \leq V_{\text{IN}} \leq 7\text{V}, 0\text{mA} \leq I_{\text{OUT}} \leq 4\text{A}$ $4.85\text{V} \leq V_{\text{IN}} \leq 7\text{V}, 0\text{mA} \leq I_{\text{OUT}} \leq 4\text{A}$	●	3.235 (-2%)	3.300	3.365 (+2%)	V
		●	3.313 (-2%)	3.380	3.465 (+2.5%)	V	
		●	3.381 (-2%)	3.450	3.519 (+2%)	V	
		●	3.400 (-5.5%)	3.600	3.672 (+2%)	V	
		●	3.450 (-4%)	3.600	3.672 (+2%)	V	
		●	3.431 (-4.7%)	3.600	3.672 (+2%)	V	
		●	3.481 (-3.3%)	3.600	3.672 (+2%)	V	
		●	3.474 (-3.5%)	3.600	3.672 (+2%)	V	
		●	3.528 (-2%)	3.600	3.672 (+2%)	V	
		●	3.450 (-4%)	3.600	3.672 (+2%)	V	
		●	3.492 (-3%)	3.600	3.672 (+2%)	V	
Line Regulation (Notes 2, 3)	LT1584/5/7 LT1584/5/7-3.3 LT1584/5-3.38 LT1584/5/7-3.45 LT1584/5/7-3.6	$2.75\text{V} \leq V_{\text{IN}} \leq 7\text{V}, I_{\text{OUT}} = 10\text{mA}$ $4.75\text{V} \leq V_{\text{IN}} \leq 7\text{V}, I_{\text{OUT}} = 0\text{mA}$ $4.75\text{V} \leq V_{\text{IN}} \leq 7\text{V}, I_{\text{OUT}} = 0\text{mA}$ $4.75\text{V} \leq V_{\text{IN}} \leq 7\text{V}, I_{\text{OUT}} = 0\text{mA}$ $4.75\text{V} \leq V_{\text{IN}} \leq 7\text{V}, I_{\text{OUT}} = 0\text{mA}$	●		0.005	0.2	%
Load Regulation (Notes 2, 3, 4)	LT1584/5/7 LT1584/5/7-3.3 LT1584/5-3.38 LT1584/5/7-3.45 LT1584/5/7-3.6	$(V_{\text{IN}} - V_{\text{OUT}}) = 3\text{V}, T_J = 25^\circ\text{C}, 10\text{mA} \leq I_{\text{OUT}} \leq I_{\text{FULL LOAD}}$ $V_{\text{IN}} = 5\text{V}, T_J = 25^\circ\text{C}, 0\text{mA} \leq I_{\text{OUT}} \leq I_{\text{FULL LOAD}}$ $V_{\text{IN}} = 5\text{V}, T_J = 25^\circ\text{C}, 0\text{mA} \leq I_{\text{OUT}} \leq I_{\text{FULL LOAD}}$ $V_{\text{IN}} = 5\text{V}, T_J = 25^\circ\text{C}, 0\text{mA} \leq I_{\text{OUT}} \leq I_{\text{FULL LOAD}}$ $V_{\text{IN}} = 5.25\text{V}, T_J = 25^\circ\text{C}, 0\text{mA} \leq I_{\text{OUT}} \leq I_{\text{FULL LOAD}}$	●		0.05	0.3	%
				0.05	0.5	%	
Dropout Voltage	LT1585/7 LT1585/7-3.3 LT1585-3.38 LT1585/7-3.45 LT1585/7-3.6 LT1585 LT1585-3.3 LT1585-3.38 LT1585-3.45 LT1585-3.6 LT1584 LT1584-3.3 LT1584-3.38 LT1584-3.45 LT1584-3.6 LT1584IT-3.3	$\Delta V_{\text{REF}} = 1\%, I_{\text{OUT}} = 3\text{A}$ $\Delta V_{\text{OUT}} = 1\%, I_{\text{OUT}} = 3\text{A}$ $\Delta V_{\text{OUT}} = 1\%, I_{\text{OUT}} = 3\text{A}$ $\Delta V_{\text{OUT}} = 1\%, I_{\text{OUT}} = 3\text{A}$ $\Delta V_{\text{OUT}} = 1\%, I_{\text{OUT}} = 3\text{A}$ $\Delta V_{\text{REF}} = 1\%, I_{\text{OUT}} = 4.6\text{A}, T_J \geq 25^\circ\text{C}$ $\Delta V_{\text{REF}} = 1\%, I_{\text{OUT}} = 4\text{A}, T_J < 25^\circ\text{C}$ $\Delta V_{\text{OUT}} = 1\%, I_{\text{OUT}} = 4.6\text{A}, T_J \geq 25^\circ\text{C}$ $\Delta V_{\text{OUT}} = 1\%, I_{\text{OUT}} = 4\text{A}, T_J < 25^\circ\text{C}$ $\Delta V_{\text{OUT}} = 1\%, I_{\text{OUT}} = 4\text{A}$ $\Delta V_{\text{OUT}} = 1\%, I_{\text{OUT}} = 4\text{A}$ $\Delta V_{\text{OUT}} = 1\%, I_{\text{OUT}} = 4\text{A}$ $\Delta V_{\text{REF}} = 1\%, I_{\text{OUT}} = 6\text{A}$ $\Delta V_{\text{OUT}} = 1\%, I_{\text{OUT}} = 6\text{A}$ $\Delta V_{\text{OUT}} = 1\%, I_{\text{OUT}} = 6\text{A}$ $\Delta V_{\text{OUT}} = 1\%, I_{\text{OUT}} = 6\text{A}$ $\Delta V_{\text{OUT}} = 1\%, I_{\text{OUT}} = 6\text{A}$ $T_J \geq 25^\circ\text{C}$ $T_J < 25^\circ\text{C}$ $T_J < 25^\circ\text{C}$	●		1.150	1.300	V
		●		1.200	1.400	V	
		●		1.200	1.300	V	
		●		1.200	1.350	V	
		●		1.200	1.450	V	

LT1584/LT1585/LT1587

ELECTRICAL CHARACTERISTICS

The ● denotes the specifications which apply over the full operating temperature range, otherwise specifications are at $T_A = 25^\circ\text{C}$.

PARAMETER	CONDITIONS	MIN	TYP	MAX	UNITS	
Dropout Voltage	LT1584 LT1584-3.3 LT1584-3.38 LT1584-3.45 LT1584-3.6 LT1584IT-3.3	$\Delta V_{REF} = 1\%$, $I_{OUT} = 7A$ $\Delta V_{OUT} = 1\%$, $I_{OUT} = 7A$ $\Delta V_{OUT} = 1\%$, $I_{OUT} = 7A$ $\Delta V_{OUT} = 1\%$, $I_{OUT} = 7A$ $\Delta V_{OUT} = 1\%$, $I_{OUT} = 7A$ $T_J < 25^\circ\text{C}$	● ●	1.250 1.250	1.400 1.500	V V
	Current Limit (Note 4)	LT1584 LT1584-3.3 LT1584-3.38 LT1584-3.45 LT1584-3.6	●	7.100	8.250	A
	LT1585 LT1585-3.3	$(V_{IN} - V_{OUT}) = 5.5V$ $(V_{IN} - V_{OUT}) = 5.5V$ $T_J \geq 25^\circ\text{C}$ $T_J < 25^\circ\text{C}$	● ●	4.600 4.100	5.25 5.25	A A
	LT1585-3.38 LT1585-3.45 LT1585-3.6	$(V_{IN} - V_{OUT}) = 5.5V$ $(V_{IN} - V_{OUT}) = 5.5V$ $(V_{IN} - V_{OUT}) = 5.5V$	●	4.100	4.750	A
	LT1587 LT1587-3.3 LT1587-3.45 LT1587-3.6	$(V_{IN} - V_{OUT}) = 5.5V$ $(V_{IN} - V_{OUT}) = 5.5V$ $(V_{IN} - V_{OUT}) = 5.5V$ $(V_{IN} - V_{OUT}) = 5.5V$	●	3.100	3.750	A
	Adjust Pin Current	LT1584/5/7	●	55	120	μA
Adjust Pin Current Change (Note 4)	LT1584 LT1585/7	$1.5V \leq (V_{IN} - V_{OUT}) \leq 3V$, $10\text{mA} \leq I_{OUT} \leq I_{FULL\ LOAD}$ $1.5V \leq (V_{IN} - V_{OUT}) \leq 5.75V$, $10\text{mA} \leq I_{OUT} \leq I_{FULL\ LOAD}$	●	0.2	5	μA
Minimum Load Current	LT1584/5/7	$1.5V \leq (V_{IN} - V_{OUT}) \leq 5.75V$	●	2	10	mA
Quiescent Current	LT1584/5/7-3.3 LT1584/5-3.38 LT1584/5/7-3.45 LT1584/5/7-3.6 LT1584IT-3.3	$V_{IN} = 5V$ $V_{IN} = 5V$ $V_{IN} = 5V$ $V_{IN} = 5V$ $V_{IN} = 5V$	● ●	8 8	13 15	mA mA
	Ripple Rejection	LT1584 LT1584-3.3 LT1584-3.38 LT1584-3.45 LT1584-3.6 LT1585 LT1585-3.3 LT1585-3.38 LT1585-3.45 LT1585-3.6 LT1587 LT1587-3.3 LT1587-3.45 LT1587-3.6	$f = 120\text{Hz}$, $C_{OUT} = 25\mu\text{F}$ Tant., $(V_{IN} - V_{OUT}) = 2.5V$, $I_{OUT} = 7A$ $f = 120\text{Hz}$, $C_{OUT} = 25\mu\text{F}$ Tant., $V_{IN} = 5.8V$, $I_{OUT} = 7A$ $f = 120\text{Hz}$, $C_{OUT} = 25\mu\text{F}$ Tant., $V_{IN} = 5.88V$, $I_{OUT} = 7A$ $f = 120\text{Hz}$, $C_{OUT} = 25\mu\text{F}$ Tant., $V_{IN} = 5.95V$, $I_{OUT} = 7A$ $f = 120\text{Hz}$, $C_{OUT} = 25\mu\text{F}$ Tant., $V_{IN} = 6.1V$, $I_{OUT} = 7A$ $f = 120\text{Hz}$, $C_{OUT} = 25\mu\text{F}$ Tant., $(V_{IN} - V_{OUT}) = 3V$, $I_{OUT} = 4.6A$, $T_J \geq 25^\circ\text{C}$ $f = 120\text{Hz}$, $C_{OUT} = 25\mu\text{F}$ Tant., $(V_{IN} - V_{OUT}) = 3V$, $I_{OUT} = 4A$, $T_J < 25^\circ\text{C}$ $f = 120\text{Hz}$, $C_{OUT} = 25\mu\text{F}$ Tant., $V_{IN} = 6.3V$, $I_{OUT} = 4.6A$, $T_J \geq 25^\circ\text{C}$ $f = 120\text{Hz}$, $C_{OUT} = 25\mu\text{F}$ Tant., $V_{IN} = 6.3V$, $I_{OUT} = 4A$, $T_J < 25^\circ\text{C}$ $f = 120\text{Hz}$, $C_{OUT} = 25\mu\text{F}$ Tant., $V_{IN} = 6.38V$, $I_{OUT} = 4A$ $f = 120\text{Hz}$, $C_{OUT} = 25\mu\text{F}$ Tant., $V_{IN} = 6.45V$, $I_{OUT} = 4A$ $f = 120\text{Hz}$, $C_{OUT} = 25\mu\text{F}$ Tant., $V_{IN} = 6.6V$, $I_{OUT} = 4A$ $f = 120\text{Hz}$, $C_{OUT} = 25\mu\text{F}$ Tant., $(V_{IN} - V_{OUT}) = 3V$, $I_{OUT} = 3A$ $f = 120\text{Hz}$, $C_{OUT} = 25\mu\text{F}$ Tant., $V_{IN} = 6.3V$, $I_{OUT} = 3A$ $f = 120\text{Hz}$, $C_{OUT} = 25\mu\text{F}$ Tant., $V_{IN} = 6.45V$, $I_{OUT} = 3A$ $f = 120\text{Hz}$, $C_{OUT} = 25\mu\text{F}$ Tant., $V_{IN} = 6.6V$, $I_{OUT} = 3A$	●	60	72

ELECTRICAL CHARACTERISTICS The ● denotes the specifications which apply over the full operating temperature range, otherwise specifications are at $T_A = 25^\circ\text{C}$.

PARAMETER	CONDITIONS		MIN	TYP	MAX	UNITS
Thermal Regulation	LT1584/5/7 LT1584/5/7-3.3 LT1584/5-3.38 LT1584/5/7-3.45 LT1584/5/7-3.6	$T_A = 25^\circ\text{C}$, 30ms pulse $T_A = 25^\circ\text{C}$, 30ms pulse $T_A = 25^\circ\text{C}$, 30ms pulse $T_A = 25^\circ\text{C}$, 30ms pulse $T_A = 25^\circ\text{C}$, 30ms pulse		0.004	0.02	%/W
Temperature Stability		●		0.5		%
Long-Term Stability		$T_A = 125^\circ\text{C}$, 1000 Hrs.		0.03	1.0	%
RMS Output Noise (% of V_{OUT})		$T_A = 25^\circ\text{C}$, $10\text{Hz} \leq f \leq 10\text{kHz}$		0.003		%
Thermal Resistance Junction to Case	LT1584 LT1585 LT1585 LT1587 LT1587	T Package: Control Circuitry/Power Transistor T Package: Control Circuitry/Power Transistor M Package: Control Circuitry/Power Transistor T Package: Control Circuitry/Power Transistor M Package: Control Circuitry/Power Transistor			0.65/2.7 0.7/3.0 0.7/3.0 0.7/3.0 0.7/3.0	$^\circ\text{C}/\text{W}$ $^\circ\text{C}/\text{W}$ $^\circ\text{C}/\text{W}$ $^\circ\text{C}/\text{W}$ $^\circ\text{C}/\text{W}$

Note 1: Absolute Maximum Ratings are those values beyond which the life of a device may be impaired.

Note 2: See thermal regulation specifications for changes in output voltage due to heating effects. Load and line regulation are measured at a constant junction temperature by low duty cycle pulse testing.

Note 3: Line and load regulation are guaranteed up to the maximum power dissipation (25W for the LT1584 in T package, 26.5W for the LT1585 in T package, 18W for the LT1587 in T package). Power dissipation is determined by input/output differential and the output current. Guaranteed

maximum output power will not be available over the full input/output voltage range.

Note 4: $I_{FULL\ LOAD}$ is defined as the maximum value of output load current as a function of input-to-output voltage. $I_{FULL\ LOAD}$ is equal to 7A for the LT1584, 4.6A at $T_J \geq 25^\circ\text{C}$ and 4A at $T_J < 25^\circ\text{C}$ for the LT1585/LT1585-3.3 and 3A for the LT1587. The remaining LT1585 fixed voltage versions are 4A. The LT1585 and LT1587 have constant current limit with changes in input-to-output voltage. The LT1584 has variable current limit which decreases about 4A as input-to-output voltage increases from 3V to 7V.

TYPICAL PERFORMANCE CHARACTERISTICS

LT1584 Dropout Voltage vs Output Current

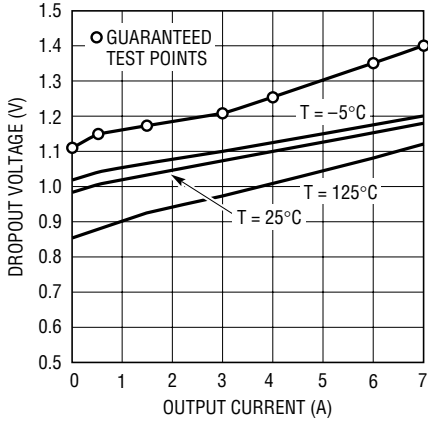

LT1584 • TPC01

LT1584 Short-Circuit Current vs Input/Output Differential

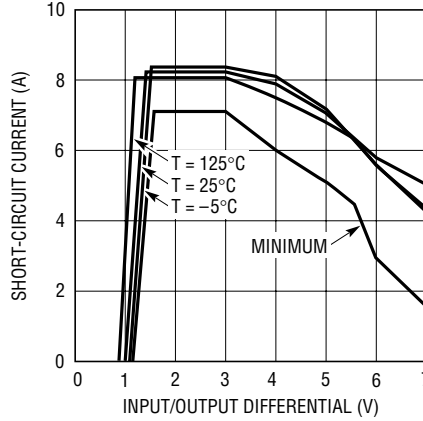

LT1584 • TPC02

LT1584 Load Regulation vs Temperature

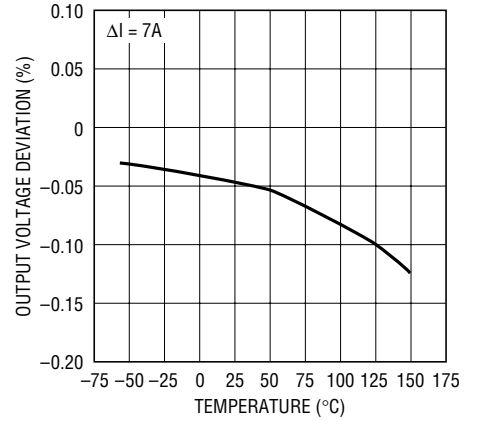

LT1584 • TPC03

LT1585 Dropout Voltage vs Output Current

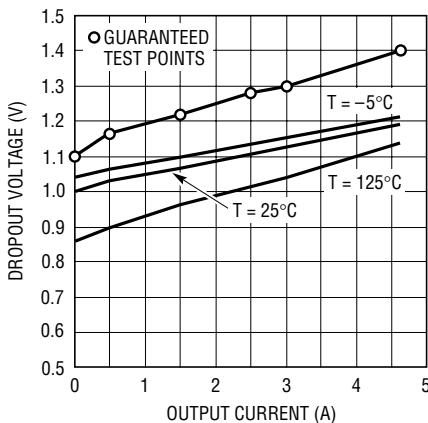

LT1585 • TPC04

LT1585 Short-Circuit Current vs Temperature

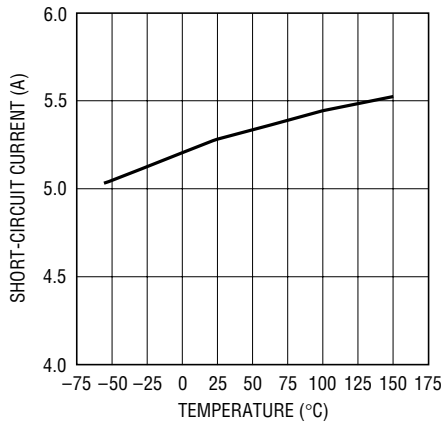

LT1584 • TPC05

LT1585 Load Regulation vs Temperature

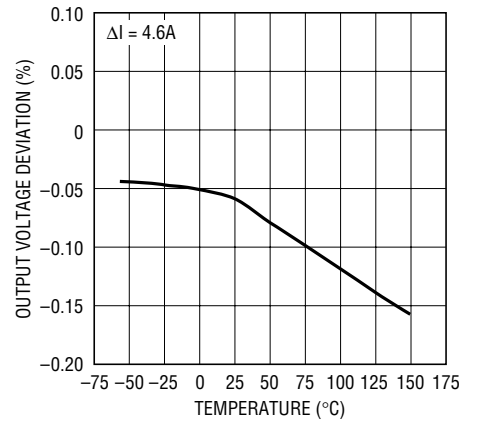

LT1584 • TPC03

LT1587 Dropout Voltage vs Output Current

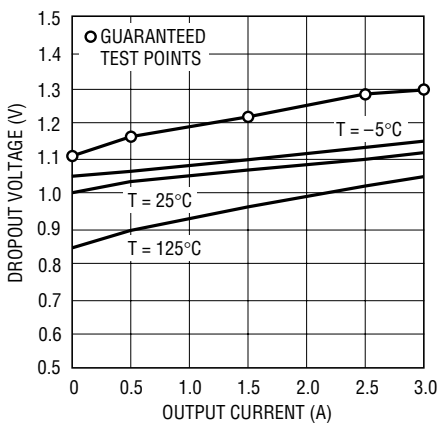

LT1584 • TPC07

LT1587 Short-Circuit Current vs Temperature

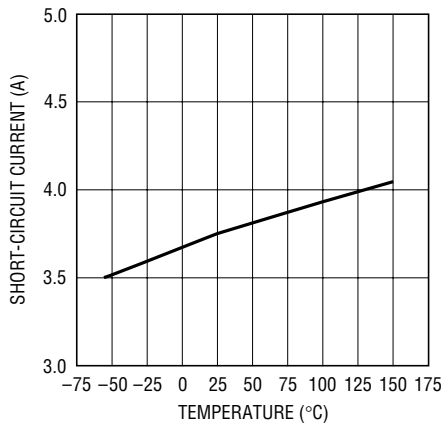

LT1584 • TPC05

LT1587 Load Regulation vs Temperature

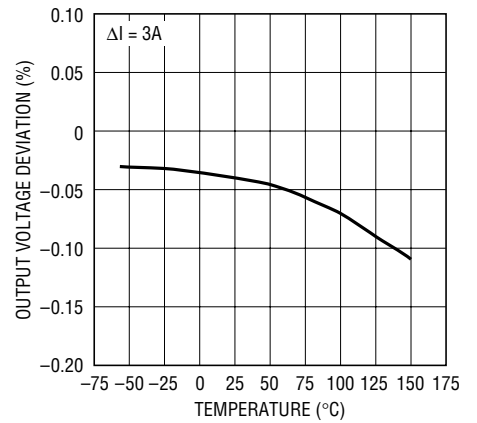

LT1584 • TPC09

TYPICAL PERFORMANCE CHARACTERISTICS

LT1584/5/7 Reference Voltage vs Temperature

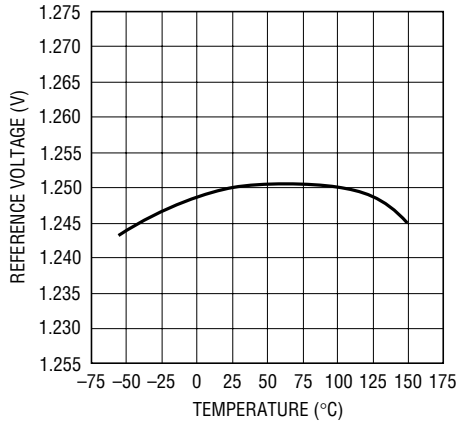

LT1584 • TPC10

Output Voltage vs Temperature Using Adjustable LT1584/5/7



LT1584 • TPC11

LT1584/5/7-3.XX Output Voltage vs Temperature



LT1584 • TPC12

LT1584/5/7 Minimum Load Current vs Temperature



LT1584 • TPC13

LT1584/5/7 Adjust Pin Current vs Temperature



LT1584 • TPC14

LT1584/5/7-3.XX Quiescent Current vs Temperature



LT1584 • TPC15

LT1584/5/7 Ripple Rejection vs Frequency

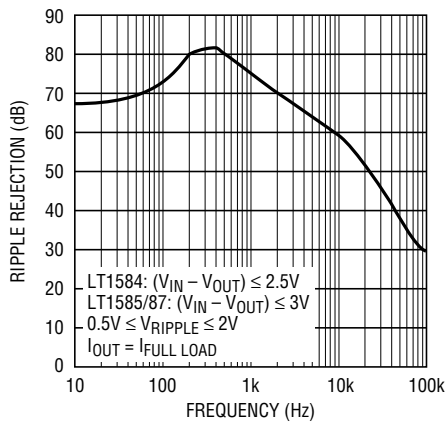

LT1584 • TPC16

LT1585/7 Maximum Power Dissipation*

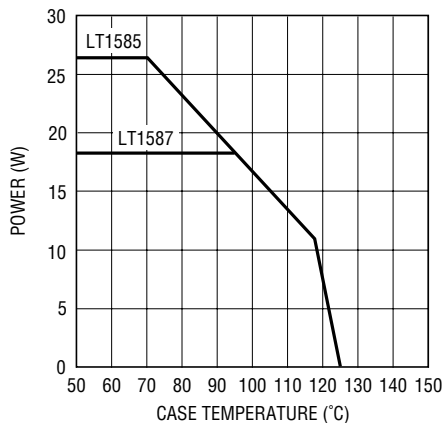

LT1584 • TPC17

*AS LIMITED BY MAXIMUM JUNCTION TEMPERATURE

LT1584 Maximum Power Dissipation*

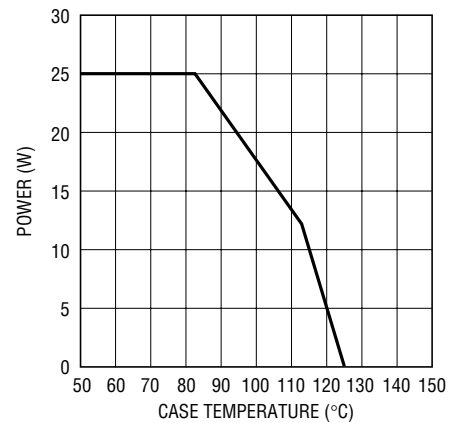

LT1584 • TPC18

*AS LIMITED BY MAXIMUM JUNCTION TEMPERATURE

SIMPLIFIED SCHEMATIC



APPLICATIONS INFORMATION

General

The LT1584/LT1585/LT1587 family of three-terminal regulators is easy to use and has all the protection features expected in high performance linear regulators. The devices are short-circuit protected, safe-area protected, and provide thermal shutdown to turn off the regulators should the junction temperature exceed about 150°C. The LT1584/LT1585/LT1587 family includes adjustable and fixed voltage versions.

These ICs are pin compatible with the LT1083/LT1084/LT1085 family of linear regulators but offer lower dropout voltage and faster transient response. The trade-off for this improved performance is a 7V maximum supply voltage. Similar to the LT1083/LT1084/LT1085 family, the LT1584/LT1585/LT1587 regulators require an output capacitor for stability. However, the improved frequency compensation permits the use of capacitors with much lower ESR while still maintaining stability. This is critical in addressing the needs of modern, low voltage, high speed microprocessors.

Current generation microprocessors cycle load current from almost zero to amps in tens of nanoseconds. Output voltage tolerances are tighter and include transient response as part of the specification. The LT1584/LT1585/LT1587 family is specifically designed to meet the fast current load-step requirements of these microprocessors and saves total cost by needing less output capacitance in order to maintain regulation.

Stability

The circuit design in the LT1584/LT1585/LT1587 family requires the use of an output capacitor as part of the frequency compensation. For all operating conditions, the addition of a 22 μ F solid tantalum or a 100 μ F aluminum electrolytic on the output ensures stability. Normally, the LT1584/LT1585/LT1587 can use smaller value capacitors. Many different types of capacitors are available and have widely varying characteristics. These capacitors differ in capacitor tolerance (sometimes ranging up to $\pm 100\%$), equivalent series resistance, equivalent series inductance, and capacitance temperature coefficient. The LT1584/

LT1585/LT1587 frequency compensation optimizes frequency response with low ESR capacitors. In general, use capacitors with an ESR of less than 1 Ω .

On the adjustable LT1584/LT1585/LT1587, bypassing the adjust terminal improves ripple rejection and transient response. Bypassing the adjust pin increases the required output capacitor value. The value of 22 μ F tantalum or 100 μ F aluminum covers all cases of bypassing the adjust terminal. With no adjust pin bypassing, smaller values of capacitors provide equally good results.

Normally, capacitor values on the order of several hundred microfarads are used on the output of the regulators to ensure good transient response with heavy load current changes. Output capacitance can increase without limit and larger values of output capacitance further improve the stability and transient response of the LT1584/LT1585/LT1587 family.

Large load current changes are exactly the situation presented by modern microprocessors. The load current step contains higher order frequency components that the output decoupling network must handle until the regulator throttles to the load current level. Capacitors are not ideal elements and contain parasitic resistance and inductance. These parasitic elements dominate the change in output voltage at the beginning of a transient load step change. The ESR of the output capacitors produces an instantaneous step in output voltage ($\Delta V = \Delta I \times \text{ESR}$). The ESL of the output capacitors produces a droop proportional to the rate of change of output current ($V = L \times \Delta I / \Delta t$). The output capacitance produces a change in output voltage proportional to the time until the regulator can respond ($\Delta V = \Delta t \times \Delta I / C$). These transient effects are illustrated in Figure 1.

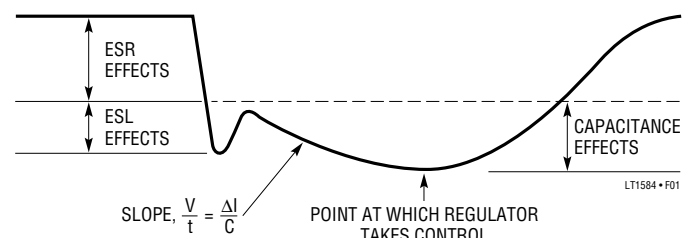

Figure 1

APPLICATIONS INFORMATION

The use of capacitors with low ESR, low ESL, and good high frequency characteristics is critical in meeting the output voltage tolerances of these high speed microprocessors. These requirements dictate a combination of high quality, surface mount tantalum capacitors and ceramic capacitors. The location of the decoupling network is critical to transient response performance. Place the decoupling network as close as possible to the processor pins because trace runs from the decoupling capacitors to the processor pins are inductive. The ideal location for the decoupling network is actually inside the microprocessor socket cavity. In addition, use large power and ground plane areas to minimize distribution drops.

A possible stability problem that occurs in monolithic linear regulators is current limit oscillations. The LT1585/LT1587 essentially have a flat current limit over the range of input supply voltage. The lower current limit rating and 7V maximum supply voltage rating for these devices permit this characteristic. Current limit oscillations are typically nonexistent, unless the input and output decoupling capacitors for the regulators are mounted several inches from the terminals. The LT1584 differs from the LT1585/LT1587 and provides current limit foldback as input-to-output differential voltage increases. This safe-area characteristic exhibits a negative impedance because increasing voltage causes output current to decrease. Negative resistance during current limit is not unique to the LT1584 devices and is present on many power IC regulators. The value of the negative resistance is a function of how fast the current limit is folded back as input-to-output voltage increases. This negative resistance can react with capacitors and inductors on the input and output to cause oscillation during current limit. Depending on the values of series resistances, the overall system may end up unstable. However, the oscillation causes no problem and the IC remains protected. In general, if this problem occurs and is unacceptable, increasing the amount of output capacitance helps dampen the system.

Protection Diodes

In normal operation, the LT1584/LT1585/LT1587 family does not require any protection diodes. Older three-terminal regulators require protection diodes between the out-

put pin and the input pin or between the adjust pin and the output pin to prevent die overstress.

On the adjustable LT1584/LT1585/LT1587, internal resistors limit internal current paths on the adjust pin. Therefore, even with bypass capacitors on the adjust pin, no protection diode is needed to ensure device safety under short-circuit conditions.

A protection diode between the input and output pins is usually not needed. An internal diode between the input and output pins on the LT1584/LT1585/LT1587 family can handle microsecond surge currents of 50A to 100A. Even with large value output capacitors it is difficult to obtain those values of surge currents in normal operation. Only with large values of output capacitance, such as 1000 μ F to 5000 μ F, and with the input pin instantaneously shorted to ground can damage occur. A crowbar circuit at the input of the LT1584/LT1585/LT1587 can generate those levels of current, and a diode from output to input is then recommended. This is shown in Figure 2. Usually, normal power supply cycling or system "hot plugging and unplugging" will not generate current large enough to do any damage.

The adjust pin can be driven on a transient basis ± 7 V with respect to the output, without any device degradation. As with any IC regulator, exceeding the maximum input-to-output voltage differential causes the internal transistors to break down and none of the protection circuitry is then functional.

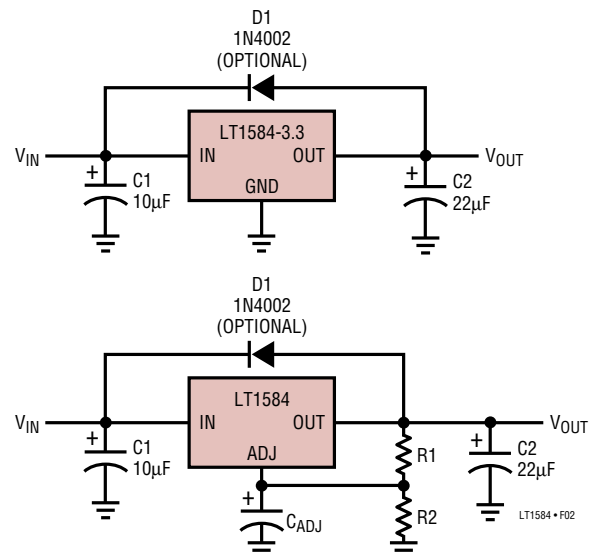

Figure 2

APPLICATIONS INFORMATION

Overload Recovery

The LT1584 devices have safe-area protection similar to the LT1083/LT1084/LT1085. The safe-area protection decreases current limit as input-to-output voltage increases. This behavior keeps the power transistor inside a safe operating region for all values of input-to-output voltage. The LT1584 protection circuitry provides some output current at all values of input-to-output voltage up to the 7V maximum supply voltage. When power is first applied, the input voltage rises and the output voltage follows the input. The input-to-output voltage remains small and the regulator can supply large output currents. This action permits the regulator to start-up into very heavy loads.

With higher input voltages, a problem can occur where the removal of an output short does not permit the output voltage to recover. This problem is not unique to the LT1584 devices and is present on the LT1083/LT1084/LT1085 family and older generation linear regulators. The problem occurs with a heavy output load, a high input voltage, and a low output voltage. An example is immediately after the removal of a short circuit. The load line of such a load may intersect the output current curve at two points. If this happens, two stable output operating points exist for the regulator. With this double intersection, the power supply may require cycling down to zero and back up again to make the output recover. This situation does not occur with the LT1585/LT1587 because no foldback circuitry is required to provide safe-area protection.

Ripple Rejection

The typical curve for ripple rejection reflects values for the LT1584/LT1585/LT1587 fixed output voltage parts between 3.3V and 3.6V. In applications that require improved ripple rejection, use the adjustable devices. A bypass capacitor from the adjust pin to ground reduces the output ripple by the ratio of $V_{OUT}/1.25V$. The impedance of the adjust pin capacitor at the ripple frequency should be less than the value of R1 (typically in the range of 100Ω to 120Ω) in the feedback divider network in Figure 2. Therefore, the value of the required adjust pin capacitor is a function of the input ripple frequency. For example, if R1 equals 100Ω and the ripple frequency equals 120Hz, the

adjust pin capacitor should be 22μF. At 10kHz, only 0.22μF is needed.

Output Voltage

The LT1584/LT1585/LT1587 adjustable regulators develop a 1.25V reference voltage between the output pin and the adjust pin (see Figure 3). Placing a resistor R1 between these two terminals causes a constant current to flow through R1 and down through R2 to set the overall output voltage. Normally, this current is the specified minimum load current of 10mA. The current out of the adjust pin adds to the current from R1 and is typically 55μA. Its output voltage contribution is small and only needs consideration when very precise output voltage setting is required.

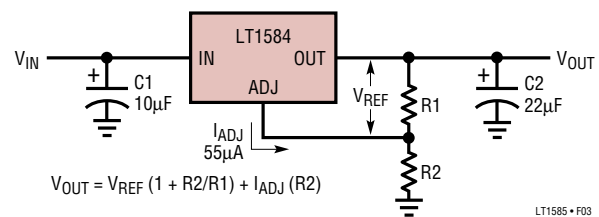

Figure 3. Basic Adjustable Regulator

Load Regulation

It is not possible to provide true remote load sensing because the LT1584/LT1585/LT1587 are three-terminal devices. Load regulation is limited by the resistance of the wire connecting the regulators to the load. Load regulation per the data sheet specification is measured at the bottom of the package.

For fixed voltage devices, negative side sensing is a true Kelvin connection with the ground pin of the device returned to the negative side of the load. This is illustrated in Figure 4.

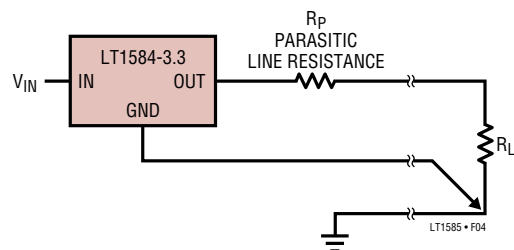

Figure 4. Connection for Best Load Regulation

APPLICATIONS INFORMATION

For adjustable voltage devices, negative side sensing is a true Kelvin connection with the bottom of the output divider returned to the negative side of the load. The best load regulation is obtained when the top of resistor divider R1 connects directly to the regulator output and not to the load. Figure 5 illustrates this point. If R1 connects to the load, the effective resistance between the regulator and the load is:

$$R_P \times (1 + R_2/R_1), R_P = \text{Parasitic Line Resistance}$$

The connection shown in Figure 5 does not multiply R_P by the divider ratio. As an example, R_P is about four milliohms per foot with 16-gauge wire. This translates to 4mV per foot at 1A load current. At higher load currents, this drop represents a significant percentage of the overall regulation. It is important to keep the positive lead between the regulator and the load as short as possible and to use large wire or PC board traces.



Figure 5. Connection for Best Load Regulation

Thermal Considerations

The LT1584/LT1585/LT1587 family protects the device under overload conditions with internal power and thermal limiting circuitry. However, for normal continuous load conditions, do not exceed maximum junction temperature ratings. It is important to consider all sources of thermal resistance from junction-to-ambient. These sources include the junction-to-case resistance, the case-to-heat sink interface resistance, and the heat sink resistance. Thermal resistance specifications have been developed to more accurately reflect device temperature and ensure safe operating temperatures. The electrical characteristics section provides a separate thermal resistance and maximum junction temperature for both the control circuitry and the power transistor. Older regulators, with a single junction-to-case thermal resistance specification, use an average of the two values provided here and allow excessive junction temperatures under certain conditions of ambient temperature and heat sink resistance. Calculate the maximum junction temperature for both sections to ensure that both thermal limits are met.

Junction-to-case thermal resistance is specified from the IC junction to the bottom of the case directly below the die. This is the lowest resistance path for heat flow. Proper mounting ensures the best thermal flow from this area of the package to the heat sink. Linear Technology strongly recommends thermal compound at the case-to-heat sink interface. Use a thermally conductive spacer if the case of the device must be electrically isolated and include its

APPLICATIONS INFORMATION

contribution to the total thermal resistance. Please consult "Mounting Considerations for Power Semiconductors" 1990 Linear Applications Handbook, Volume I, Pages RR3-1 to RR3-20. The output connects to the case of all devices in the LT1584/LT1585/LT1587 series.

For example, using an LT1585CT-3.3 (TO-220, commercial) and assuming:

$$V_{IN}(\text{Max Continuous}) = 5.25\text{V} (5\text{V} + 5\%), V_{OUT} = 3.3\text{V}, I_{OUT} = 4.6\text{A}$$

$$T_A = 70^\circ\text{C}, \theta_{\text{HEAT SINK}} = 4^\circ\text{C/W}$$

$$\theta_{\text{CASE-TO-HEAT SINK}} = 1^\circ\text{C/W} (\text{with Thermal Compound})$$

Power dissipation under these conditions is equal to:

$$P_D = (V_{IN} - V_{OUT})(I_{OUT}) = (5.25 - 3.3)(4.6) = 9\text{W}$$

Junction temperature will be equal to:

$$T_J = T_A + P_D(\theta_{\text{HEAT SINK}} + \theta_{\text{CASE-TO-HEAT SINK}} + \theta_{JC})$$

For the Control Section:

$$T_J = 70^\circ\text{C} + 9\text{W} (4^\circ\text{C/W} + 1^\circ\text{C/W} + 0.7^\circ\text{C/W}) = 121.3^\circ\text{C}$$

$$121.3^\circ\text{C} < 125^\circ\text{C} = T_{J\text{MAX}} (\text{Control Section Commercial range})$$

For the Power Transistor:

$$T_J = 70^\circ\text{C} + 9\text{W} (4^\circ\text{C/W} + 1^\circ\text{C/W} + 3^\circ\text{C/W}) = 142^\circ\text{C}$$

$$142^\circ\text{C} < 150^\circ\text{C} = T_{J\text{MAX}} (\text{Power Transistor Commercial Range})$$

In both cases the junction temperature is below the maximum rating for the respective sections, ensuring reliable operation.

TYPICAL APPLICATIONS

Recommended LT1587-3.45 Circuit for the Intel 486™ DX4™ Overdrive Microprocessor

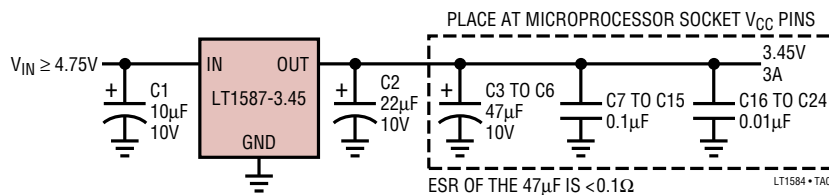

Minimum Parts Count LT1585 Adjustable Circuit for the Intel Pentium VRE Processor

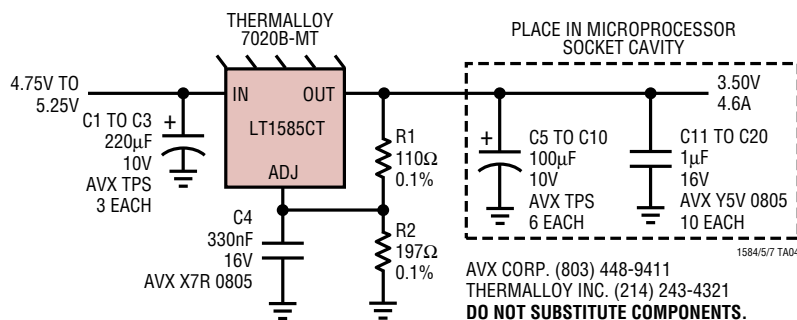

LT1585 Transient Response for 3.8A Load Current Step*

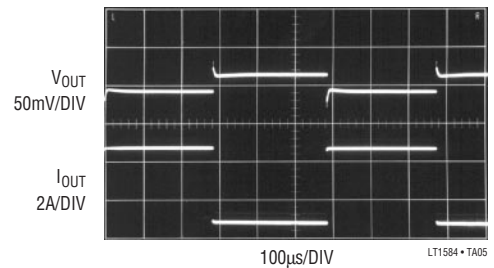

*TRANSIENT RESPONSE MEASURED WITH AN INTEL POWER VALIDATOR. V_{OUT} IS MEASURED AT THE POWER VALIDATOR

486 and DX4 are trademarks of Intel Corporation.

PACKAGE INFORMATION

M Package
3-Lead Plastic DD Pak
 (Reference LTC DWG # 05-08-1460)

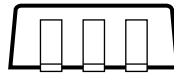

RECOMMENDED SOLDER PAD LAYOUT

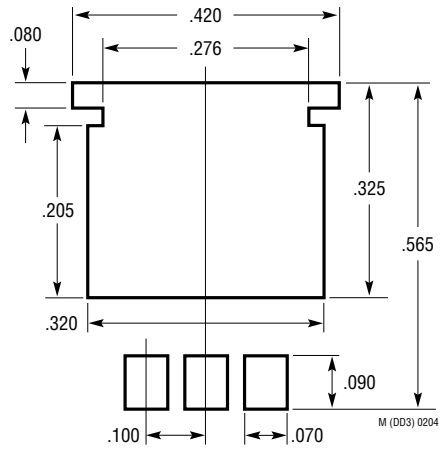

RECOMMENDED SOLDER PAD LAYOUT
 FOR THICKER SOLDER PASTE APPLICATIONS

NOTE:
 1. DIMENSIONS IN INCH/(MILLIMETER)
 2. DRAWING NOT TO SCALE

PACKAGE INFORMATION

T Package
3-Lead Plastic TO-220
 (Reference LTC DWG # 05-08-1420)



TYPICAL APPLICATIONS

Guaranteed LT1584/LT1431 Circuit for the Intel 90MHz and 100MHz Pentium Processors (Meets Intel Specifications with Worst-Case Tolerances)

- NOTES: UNLESS OTHERWISE SPECIFIED
1. ALL RESISTOR VALUES ARE OHMS, 1/8W, 5%
 2. ALL CAPACITORS ARE 50V, 20%
 3. ALL POLARIZED CAPACITORS ARE AVX TYPE TPS OR EQUIVALENT
 4. INPUT CAPACITANCE MAY BE REDUCED IF THE 5V SUPPLY IS WELL BYPASSED
 5. FOR 100MHz PENTIUM PROCESSOR, INPUT VOLTAGE MUST BE AT LEAST 4.85V AT THE REGULATOR INPUT
 6. FOR PENTIUM VRE PROCESSOR, R4 NOT INSTALLED
- FOR 3.3V OUTPUT, INSTALL 0Ω JUMPER RESISTOR R4
 7. R3A TO R3E ARE B.I. TECHNOLOGY 627V/100

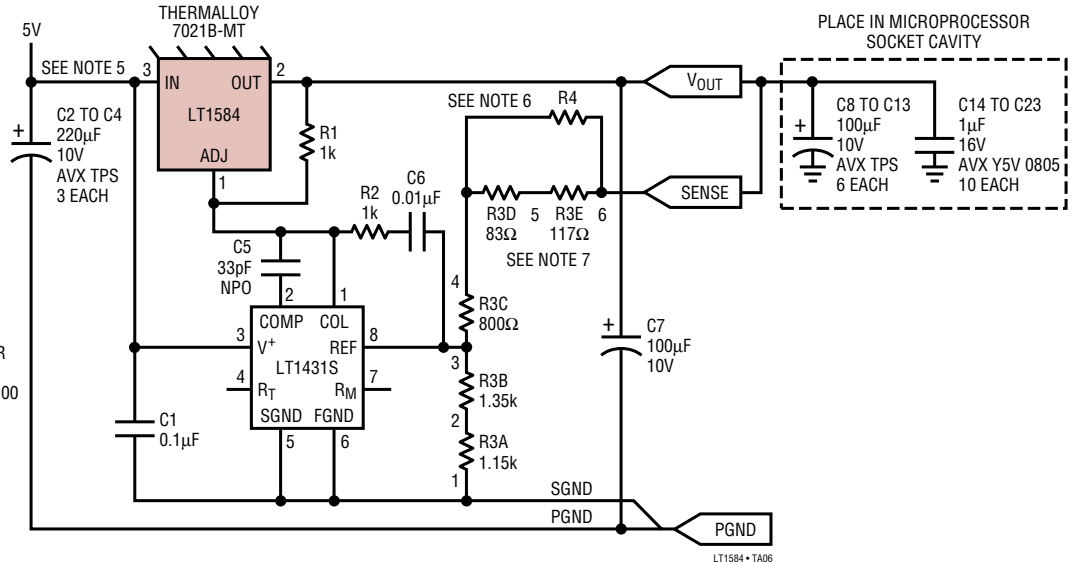

**LT1584/LT1431 Transient Response
for 3.8A Load Current Step***

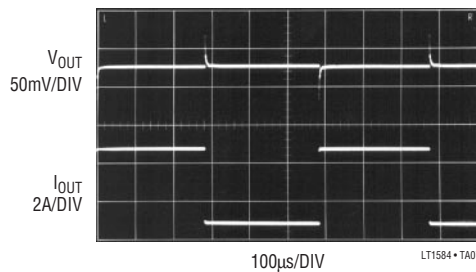

* TRANSIENT RESPONSE MEASURED WITH AN INTEL POWER VALIDATOR. V_{OUT} IS MEASURED AT THE POWER VALIDATOR

RELATED PARTS

PART NUMBER	DESCRIPTION	COMMENTS
LT1083/84/85	7.5A, 5A, 3A Low Dropout Linear Regulators	Fixed Output at 3.3V, 3.6V, 5V and 12V, V _{IN} to 25V
LT1083/84/85	7.5A, 5A, 3A Low Dropout Linear Regulators	Adjustable Output with up to 30V (V _{IN} - V _{OUT}) Differential
LT1086	1.5A Low Dropout Linear Regulator	Both Fixed and Adjustable Versions, (V _{IN} - V _{OUT}) to 30V
LT1521	300mA Low Dropout Linear Regulator with 12μA Quiescent Current and Shutdown	Both Fixed and Adjustable Versions, Surface Mount Package Available
LT1529	3A Low Dropout Linear Regulator with 50μA Quiescent Current and Shutdown	Both Fixed and Adjustable Versions, Surface Mount Package Available
LT1580	7A Very Low Dropout Linear Regulator	540mV Dropout at 7A, Remote Sensing

Looking for pricing, stock, or lifecycle information?

Click below to explore more details on WIN SOURCE:

 [View LT1587CT-3.45#PBF on WIN SOURCE](#)

 [Analog Devices Inc. Information](#)

Optimize Your Supply Chain with WIN SOURCE Solutions

-  Global Sourcing Solution
-  Obsolete Management
-  Cost Control Management
-  Shortage Management
-  Alternative Solution
-  Excess Inventory Management