



**THE DATASHEET OF
LT1819CS8#TRPBF**



FEATURES

- 400MHz Gain Bandwidth Product
- 2500V/ μ s Slew Rate
- -85dBc Distortion at 5MHz
- 9mA Supply Current Per Amplifier
- 6nV/ $\sqrt{\text{Hz}}$ Input Noise Voltage
- Unity-Gain Stable
- 1.5mV Maximum Input Offset Voltage
- 8 μ A Maximum Input Bias Current
- 800nA Maximum Input Offset Current
- 40mA Minimum Output Current, $V_{OUT} = \pm 3V$
- $\pm 3.5V$ Minimum Input CMR, $V_S = \pm 5V$
- Specified at $\pm 5V$, Single 5V Supplies
- Operating Temperature Range: -40°C to 85°C
- Low Profile (1mm) TSOT-23 (ThinSOT™) Package

APPLICATIONS

- Wideband Amplifiers
- Buffers
- Active Filters
- Video and RF Amplification
- Communication Receivers
- Cable Drivers
- Data Acquisition Systems

DESCRIPTION

The LT®1818/LT1819 are single/dual wide bandwidth, high slew rate, low noise and distortion operational amplifiers with excellent DC performance. The LT1818/LT1819 have been designed for wider bandwidth and slew rate, much lower input offset voltage and lower noise and distortion than devices with comparable supply current. The circuit topology is a voltage feedback amplifier with the excellent slewing characteristics of a current feedback amplifier.

The output drives a 100 Ω load to $\pm 3.8V$ with $\pm 5V$ supplies. On a single 5V supply, the output swings from 1V to 4V with a 100 Ω load connected to 2.5V. The amplifier is unity-gain stable with a 20pF capacitive load without the need for a series resistor. Harmonic distortion is -85dBc up to 5MHz for a 2V_{p-p} output at a gain of 2.

The LT1818/LT1819 are manufactured on Linear Technology's advanced low voltage complementary bipolar process. The LT1818 (single op amp) is available in TSOT-23 and SO-8 packages; the LT1819 (dual op amp) is available in MSOP-8 and SO-8 packages.

LT, LT, LTC, LTM, Linear Technology and the Linear logo are registered trademarks of Linear Technology Corporation. ThinSOT is a trademark of Linear Technology Corporation. All other trademarks are the property of their respective owners.

TYPICAL APPLICATION

Single Supply Unity-Gain ADC Driver for Oversampling Applications

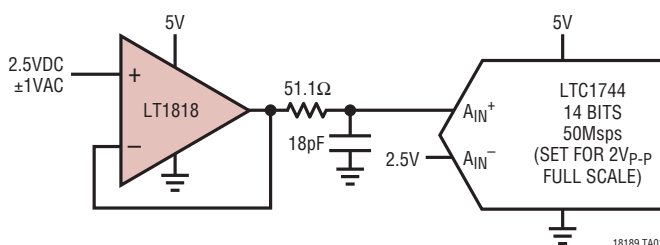

FFT of Single Supply ADC Driver

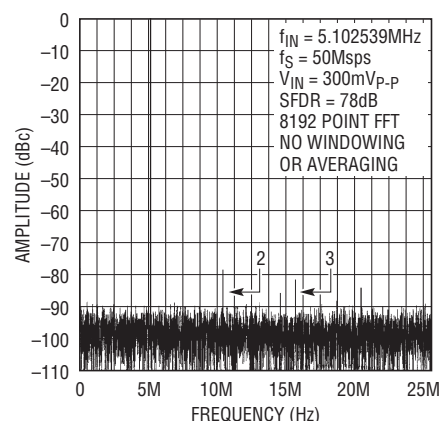

LT1818/LT1819

ABSOLUTE MAXIMUM RATINGS (Note 1)

Total Supply Voltage (V^+ to V^-)	12.6V	Specified Temperature Range (Note 9)	-40°C to 85°C
Differential Input Voltage (Transient Only, Note 2).....	$\pm 6\text{V}$	Maximum Junction Temperature.....	150°C
Output Short-Circuit Duration (Note 3)	Indefinite	Storage Temperature Range.....	-65°C to 150°C
Operating Temperature Range (Note 8)....	-40°C to 85°C	Lead Temperature (Soldering, 10 sec)	300°C

PIN CONFIGURATION

<p>TOP VIEW</p> <p>OUT 1 1 5 V^+ V^- 2 $+IN$ 3 4 $-IN$</p> <p>S5 PACKAGE 5-LEAD PLASTIC TSOT-23</p> <p>$T_{JMAX} = 150^{\circ}\text{C}$, $\theta_{JA} = 250^{\circ}\text{C/W}$ (NOTE 10)</p>	<p>TOP VIEW</p> <p>OUT A 1 8 V^+ $-IN A$ 2 7 OUT B $+IN A$ 3 6 $-IN B$ V^- 4 5 $+IN B$</p> <p>MS8 PACKAGE 8-LEAD PLASTIC MSOP</p> <p>$T_{JMAX} = 150^{\circ}\text{C}$, $\theta_{JA} = 250^{\circ}\text{C/W}$ (NOTE 10)</p>
<p>TOP VIEW</p> <p>NC 1 8 NC $-IN$ 2 7 V^+ $+IN$ 3 6 OUT V^- 4 5 NC</p> <p>S8 PACKAGE 8-LEAD PLASTIC SO</p> <p>$T_{JMAX} = 150^{\circ}\text{C}$, $\theta_{JA} = 150^{\circ}\text{C/W}$ (NOTE 10)</p>	<p>TOP VIEW</p> <p>OUT A 1 8 V^+ $-IN A$ 2 7 OUT B $+IN A$ 3 6 $-IN B$ V^- 4 5 $+IN B$</p> <p>S8 PACKAGE 8-LEAD PLASTIC SO</p> <p>$T_{JMAX} = 150^{\circ}\text{C}$, $\theta_{JA} = 150^{\circ}\text{C/W}$ (NOTE 10)</p>

ORDER INFORMATION

LEAD FREE FINISH	TAPE AND REEL	PART MARKING*	PACKAGE DESCRIPTION	SPECIFIED TEMPERATURE RANGE
LT1818CS5#PBF	LT1818CS5#TRPBF	LTF7	5-Lead Plastic TSOT-23	0°C to 70°C
LT1818IS5#PBF	LT1818IS5#TRPBF	LTF7	5-Lead Plastic TSOT-23	-40°C to 85°C
LT1818CS8#PBF	LT1818CS8#TRPBF	1818	8-Lead Plastic SO	0°C to 70°C
LT1818IS8#PBF	LT1818IS8#TRPBF	1818I	8-Lead Plastic SO	-40°C to 85°C
LT1819CMS8#PBF	LT1819CMS8#TRPBF	LTE7	8-Lead Plastic MSOP	0°C to 70°C
LT1819IMS8#PBF	LT1819IMS8#TRPBF	LTE5	8-Lead Plastic MSOP	-40°C to 85°C
LT1819CS8#PBF	LT1819CS8#TRPBF	1819	8-Lead Plastic SO	0°C to 70°C
LT1819IS8#PBF	LT1819IS8#TRPBF	1819I	8-Lead Plastic SO	-40°C to 85°C

Consult LTC Marketing for parts specified with wider operating temperature ranges. *The temperature grade is identified by a label on the shipping container. Consult LTC Marketing for information on non-standard lead based finish parts.

For more information on lead free part marking, go to: <http://www.linear.com/leadfree/>

For more information on tape and reel specifications, go to: <http://www.linear.com/tapeandree/>

ELECTRICAL CHARACTERISTICS The ● denotes the specifications which apply over the full operating temperature range, otherwise specifications are at $T_A = 25^\circ\text{C}$. (Note 9) $V_S = \pm 5\text{V}$, $V_{CM} = 0\text{V}$, unless otherwise noted.

SYMBOL	PARAMETER	CONDITIONS	MIN	TYP	MAX	UNITS
V_{OS}	Input Offset Voltage	(Note 4)		0.2	1.5	mV
		$T_A = 0^\circ\text{C}$ to 70°C	●		2.0	mV
		$T_A = -40^\circ\text{C}$ to 85°C	●		3.0	mV
$\Delta V_{OS}/\Delta T$	Input Offset Voltage Drift	$T_A = 0^\circ\text{C}$ to 70°C (Note 7)	●	10	15	$\mu\text{V}/^\circ\text{C}$
		$T_A = -40^\circ\text{C}$ to 85°C (Note 7)	●	10	30	$\mu\text{V}/^\circ\text{C}$
I_{OS}	Input Offset Current	$T_A = 0^\circ\text{C}$ to 70°C	●	60	800	nA
		$T_A = -40^\circ\text{C}$ to 85°C	●		1000	nA
			●		1200	nA
I_B	Input Bias Current	$T_A = 0^\circ\text{C}$ to 70°C	●	-2	± 8	μA
		$T_A = -40^\circ\text{C}$ to 85°C	●		± 10	μA
			●		± 12	μA
e_n	Input Noise Voltage Density	$f = 10\text{kHz}$		6		$\text{nV}/\sqrt{\text{Hz}}$
i_n	Input Noise Current Density	$f = 10\text{kHz}$		1.2		$\text{pA}/\sqrt{\text{Hz}}$
R_{IN}	Input Resistance	$V_{CM} = V^- + 1.5\text{V}$ to $V^+ - 1.5\text{V}$ Differential		1.5	5	$\text{M}\Omega$
					750	$\text{k}\Omega$
C_{IN}	Input Capacitance			1.5		pF
V_{CM}	Input Voltage Range (Positive/Negative)	Guaranteed by CMRR $T_A = -40^\circ\text{C}$ to 85°C	●	± 3.5	± 4.2	V
			●	± 3.5		V
CMRR	Common Mode Rejection Ratio	$V_{CM} = \pm 3.5\text{V}$ $T_A = 0^\circ\text{C}$ to 70°C $T_A = -40^\circ\text{C}$ to 85°C	●	75	85	dB
			●	73		dB
			●	72		dB
PSRR	Power Supply Rejection Ratio	Guaranteed by PSRR $T_A = -40^\circ\text{C}$ to 85°C	●	± 1.25	± 2	V
			●		± 2	V
PSRR	Power Supply Rejection Ratio	$V_S = \pm 2\text{V}$ to $\pm 5.5\text{V}$ $T_A = 0^\circ\text{C}$ to 70°C $T_A = -40^\circ\text{C}$ to 85°C	●	78	97	dB
			●	76		dB
			●	75		dB
A_{VOL}	Large-Signal Voltage Gain	$V_{OUT} = \pm 3\text{V}$, $R_L = 500\Omega$ $T_A = 0^\circ\text{C}$ to 70°C $T_A = -40^\circ\text{C}$ to 85°C	●	1.5	2.5	V/mV
			●	1.0		V/mV
			●	0.6		V/mV
		$V_{OUT} = \pm 3\text{V}$, $R_L = 100\Omega$ $T_A = 0^\circ\text{C}$ to 70°C $T_A = -40^\circ\text{C}$ to 85°C	●	1.0	6	V/mV
			●	0.7		V/mV
			●	0.6		V/mV
Channel Separation	$V_{OUT} = \pm 3\text{V}$, LT1819 $T_A = 0^\circ\text{C}$ to 70°C $T_A = -40^\circ\text{C}$ to 85°C	●	82	100	dB	
		●	81		dB	
		●	80		dB	
V_{OUT}	Output Swing (Positive/Negative)	$R_L = 500\Omega$, 30mV Overdrive $T_A = 0^\circ\text{C}$ to 70°C $T_A = -40^\circ\text{C}$ to 85°C	●	± 3.8	± 4.1	V
			●	± 3.7		V
			●	± 3.6		V
		$R_L = 100\Omega$, 30mV Overdrive $T_A = 0^\circ\text{C}$ to 70°C $T_A = -40^\circ\text{C}$ to 85°C	●	± 3.50	± 3.8	V
			●	± 3.25		V
			●	± 3.15		V
I_{OUT}	Output Current	$V_{OUT} = \pm 3\text{V}$, 30mV Overdrive $T_A = 0^\circ\text{C}$ to 70°C $T_A = -40^\circ\text{C}$ to 85°C	●	± 40	± 70	mA
			●	± 35		mA
			●	± 30		mA
I_{SC}	Output Short-Circuit Current	$V_{OUT} = 0\text{V}$, 1V Overdrive (Note 3) $T_A = 0^\circ\text{C}$ to 70°C $T_A = -40^\circ\text{C}$ to 85°C	●	± 100	± 200	mA
			●	± 90		mA
			●	± 70		mA
SR	Slew Rate	$A_V = 1$		2500		V/ μs
		$A_V = -1$ (Note 5) $T_A = 0^\circ\text{C}$ to 70°C $T_A = -40^\circ\text{C}$ to 85°C	●	900	1800	V/ μs
			●	750		V/ μs
●	600		V/ μs			
FPBW	Full-Power Bandwidth	6V _{P-P} (Note 6)		95		MHz

ELECTRICAL CHARACTERISTICS

The ● denotes the specifications which apply over the full operating temperature range, otherwise specifications are at $T_A = 25^\circ\text{C}$. (Note 9) $V_S = \pm 5\text{V}$, $V_{CM} = 0\text{V}$, unless otherwise noted.

SYMBOL	PARAMETER	CONDITIONS	MIN	TYP	MAX	UNITS
GBW	Gain-Bandwidth Product	$f = 4\text{MHz}$, $R_L = 500\Omega$	270	400		MHz
		$T_A = 0^\circ\text{C}$ to 70°C	260			MHz
		$T_A = -40^\circ\text{C}$ to 85°C	250			MHz
t_r , t_f	Rise Time, Fall Time	$A_V = 1$, 10% to 90%, 0.1V Step		0.6		ns
t_{PD}	Propagation Delay	$A_V = 1$, 50% to 50%, 0.1V Step		1.0		ns
OS	Overshoot	$A_V = 1$, 0.1V, $R_L = 100\Omega$		20		%
t_S	Settling Time	$A_V = -1$, 0.1%, 5V		10		ns
HD	Harmonic Distortion	HD2, $A_V = 2$, $f = 5\text{MHz}$, $V_{OUT} = 2V_{P-P}$, $R_L = 500\Omega$		-85		dBc
		HD3, $A_V = 2$, $f = 5\text{MHz}$, $V_{OUT} = 2V_{P-P}$, $R_L = 500\Omega$		-89		dBc
dG	Differential Gain	$A_V = 2$, $R_L = 150\Omega$		0.07		%
dP	Differential Phase	$A_V = 2$, $R_L = 150\Omega$		0.02		DEG
I_S	Supply Current	Per Amplifier		9	10	mA
		$T_A = 0^\circ\text{C}$ to 70°C	●		13	mA
		$T_A = -40^\circ\text{C}$ to 85°C	●		14	mA

The ● denotes the specifications which apply over the full operating temperature range, otherwise specifications are at $T_A = 25^\circ\text{C}$. (Note 9) $V_S = 5\text{V}$, 0V ; $V_{CM} = 2.5\text{V}$, R_L to 2.5V unless otherwise noted.

SYMBOL	PARAMETER	CONDITIONS	MIN	TYP	MAX	UNITS
V_{OS}	Input Offset Voltage	(Note 4)		0.4	2.0	mV
		$T_A = 0^\circ\text{C}$ to 70°C	●		2.5	mV
		$T_A = -40^\circ\text{C}$ to 85°C	●		3.5	mV
$\Delta V_{OS}/\Delta T$	Input Offset Voltage Drift	(Note 7)				
		$T_A = 0^\circ\text{C}$ to 70°C	●	10	15	$\mu\text{V}/^\circ\text{C}$
		$T_A = -40^\circ\text{C}$ to 85°C	●	10	30	$\mu\text{V}/^\circ\text{C}$
I_{OS}	Input Offset Current	$T_A = 0^\circ\text{C}$ to 70°C	●	60	800	nA
		$T_A = -40^\circ\text{C}$ to 85°C	●		1000	nA
					1200	nA
I_B	Input Bias Current	$T_A = 0^\circ\text{C}$ to 70°C	●	-2.4	± 8	μA
		$T_A = -40^\circ\text{C}$ to 85°C	●		± 10	μA
					± 12	μA
e_n	Input Noise Voltage Density	$f = 10\text{kHz}$		6		$\text{nV}/\sqrt{\text{Hz}}$
i_n	Input Noise Current Density	$f = 10\text{kHz}$		1.4		$\text{pA}/\sqrt{\text{Hz}}$
R_{IN}	Input Resistance	$V_{CM} = V^- + 1.5\text{V}$ to $V^+ - 1.5\text{V}$	1.5	5		M Ω
		Differential		750		k Ω
C_{IN}	Input Capacitance			1.5		pF
V_{CM}	Input Voltage Range (Positive)	Guaranteed by CMRR $T_A = -40^\circ\text{C}$ to 85°C	3.5	4.2		V
	Input Voltage Range (Negative)	Guaranteed by CMRR $T_A = -40^\circ\text{C}$ to 85°C	●	0.8	1.5	V
CMRR	Common Mode Rejection Ratio	$V_{CM} = 1.5\text{V}$ to 3.5V	●	73	82	dB
		$T_A = 0^\circ\text{C}$ to 70°C	●	71		dB
		$T_A = -40^\circ\text{C}$ to 85°C	●	70		dB
	Minimum Supply Voltage	Guaranteed by PSRR		± 1.25	± 2	V
		$T_A = -40^\circ\text{C}$ to 85°C	●		± 2	V
PSRR	Power Supply Rejection Ratio	$V_S = 4\text{V}$ to 11V	●	78	97	dB
		$T_A = 0^\circ\text{C}$ to 70°C	●	76		dB
		$T_A = -40^\circ\text{C}$ to 85°C	●	75		dB

ELECTRICAL CHARACTERISTICS The ● denotes the specifications which apply over the full operating temperature range, otherwise specifications are at $T_A = 25^\circ\text{C}$. (Note 9) $V_S = 5\text{V}$, 0V ; $V_{CM} = 2.5\text{V}$, R_L to 2.5V unless otherwise noted.

SYMBOL	PARAMETER	CONDITIONS	MIN	TYP	MAX	UNITS	
A_{VOL}	Large-Signal Voltage Gain	$V_{OUT} = 1.5\text{V to }3.5\text{V}$, $R_L = 500\Omega$ $T_A = 0^\circ\text{C to }70^\circ\text{C}$ $T_A = -40^\circ\text{C to }85^\circ\text{C}$	● ●	1.0 0.7	2	V/mV V/mV	
		$V_{OUT} = 1.5\text{V to }3.5\text{V}$, $R_L = 100\Omega$ $T_A = 0^\circ\text{C to }70^\circ\text{C}$ $T_A = -40^\circ\text{C to }85^\circ\text{C}$	● ●	0.7 0.5 0.4	4	V/mV V/mV V/mV	
V_{OUT}	Channel Separation	$V_{OUT} = 1.5\text{V to }3.5\text{V}$, LT1819 $T_A = 0^\circ\text{C to }70^\circ\text{C}$ $T_A = -40^\circ\text{C to }85^\circ\text{C}$	● ●	81 80 79	100	dB dB dB	
		Output Swing (Positive)	$R_L = 500\Omega$, 30mV Overdrive $T_A = 0^\circ\text{C to }70^\circ\text{C}$ $T_A = -40^\circ\text{C to }85^\circ\text{C}$	● ●	3.9 3.8 3.7	4.2	V V V
			$R_L = 100\Omega$, 30mV Overdrive $T_A = 0^\circ\text{C to }70^\circ\text{C}$ $T_A = -40^\circ\text{C to }85^\circ\text{C}$	● ●	3.7 3.6 3.5	4	V V V
Output Swing (Negative)	$R_L = 500\Omega$, 30mV Overdrive $T_A = 0^\circ\text{C to }70^\circ\text{C}$ $T_A = -40^\circ\text{C to }85^\circ\text{C}$	● ●		0.8	1.1 1.2 1.3	V V V	
	$R_L = 100\Omega$, 30mV Overdrive $T_A = 0^\circ\text{C to }70^\circ\text{C}$ $T_A = -40^\circ\text{C to }85^\circ\text{C}$	● ●		1	1.3 1.4 1.5	V V V	
I_{OUT}	Output Current	$V_{OUT} = 1.5\text{V or }3.5\text{V}$, 30mV Overdrive $T_A = 0^\circ\text{C to }70^\circ\text{C}$ $T_A = -40^\circ\text{C to }85^\circ\text{C}$	● ●	± 30 ± 25 ± 20	± 50	mA mA mA	
I_{SC}	Output Short-Circuit Current	$V_{OUT} = 2.5\text{V}$, 1V Overdrive (Note 3) $T_A = 0^\circ\text{C to }70^\circ\text{C}$ $T_A = -40^\circ\text{C to }85^\circ\text{C}$		± 80 ± 70 ± 50	± 140	mA mA mA	
SR	Slew Rate	$A_V = 1$			1000	V/ μs	
		$A_V = -1$ (Note 5) $T_A = 0^\circ\text{C to }70^\circ\text{C}$ $T_A = -40^\circ\text{C to }85^\circ\text{C}$	● ●	450 375 300	800	V/ μs V/ μs V/ μs	
FPBW	Full-Power Bandwidth	$2V_{P-P}$ (Note 6)			125	MHz	
GBW	Gain-Bandwidth Product	$f = 4\text{MHz}$, $R_L = 500\Omega$ $T_A = 0^\circ\text{C to }70^\circ\text{C}$ $T_A = -40^\circ\text{C to }85^\circ\text{C}$	● ●	240 230 220	360	MHz MHz MHz	
		Rise Time, Fall Time	$A_V = 1$, 10% to 90%, 0.1V Step			0.7	ns
t_{PD}	Propagation Delay	$A_V = 1$, 50% to 50%, 0.1V Step			1.1	ns	
OS	Overshoot	$A_V = 1$, 0.1V, $R_L = 100\Omega$			20	%	
HD	Harmonic Distortion	HD2, $A_V = 2$, $f = 5\text{MHz}$, $V_{OUT} = 2V_{P-P}$, $R_L = 500\Omega$			-72	dBc	
		HD3, $A_V = 2$, $f = 5\text{MHz}$, $V_{OUT} = 2V_{P-P}$, $R_L = 500\Omega$			-74	dBc	
dG	Differential Gain	$A_V = 2$, $R_L = 150\Omega$			0.07	%	
dP	Differential Phase	$A_V = 2$, $R_L = 150\Omega$			0.07	DEG	
I_S	Supply Current	Per Amplifier $T_A = 0^\circ\text{C to }70^\circ\text{C}$ $T_A = -40^\circ\text{C to }85^\circ\text{C}$	● ●		8.5 10 13 14	mA mA mA mA	

Note 1: Stresses beyond those listed under Absolute Maximum Ratings may cause permanent damage to the device. Exposure to any Absolute Maximum Rating condition for extended periods may affect device reliability and lifetime.

Note 2: Differential inputs of $\pm 6\text{V}$ are appropriate for transient operation only, such as during slewing. Large sustained differential inputs can cause excessive power dissipation and may damage the part.

Note 3: A heat sink may be required to keep the junction temperature below absolute maximum when the output is shorted indefinitely.

Note 4: Input offset voltage is pulse tested and is exclusive of warm-up drift.

ELECTRICAL CHARACTERISTICS

Note 5: With $\pm 5V$ supplies, slew rate is tested in a closed-loop gain of -1 by measuring the rise time of the output from $-2V$ to $2V$ with an output step from $-3V$ to $3V$. With single $5V$ supplies, slew rate is tested in a closed-loop gain of -1 by measuring the rise time of the output from $1.5V$ to $3.5V$ with an output step from $1V$ to $4V$. Falling edge slew rate is not production tested, but is designed, characterized and expected to be within 10% of the rising edge slew rate.

Note 6: Full-power bandwidth is calculated from the slew rate:

$$FPBW = SR/2\pi V_p$$

Note 7: This parameter is not 100% tested.

Note 8: The LT1818C/LT1818I and LT1819C/LT1819I are guaranteed functional over the operating temperature range of $-40^\circ C$ to $85^\circ C$.

Note 9: The LT1818C/LT1819C are guaranteed to meet specified performance from $0^\circ C$ to $70^\circ C$ and is designed, characterized and expected to meet the extended temperature limits, but is not tested at $-40^\circ C$ and $85^\circ C$. The LT1818I/LT1819I are guaranteed to meet the extended temperature limits.

Note 10: Thermal resistance (θ_{JA}) varies with the amount of PC board metal connected to the package. The specified values are for short traces connected to the leads. If desired, the thermal resistance can be significantly reduced by connecting the V^- pin to a large metal area.

TYPICAL PERFORMANCE CHARACTERISTICS

Supply Current vs Temperature

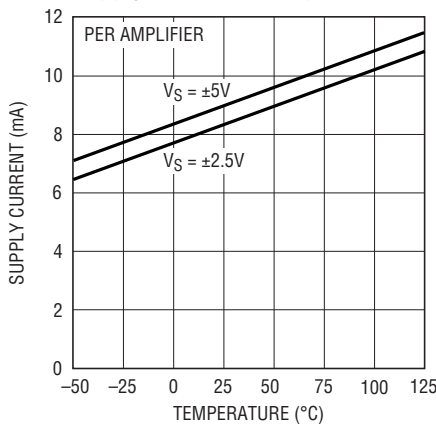

18189 G01

Input Common Mode Range vs Supply Current

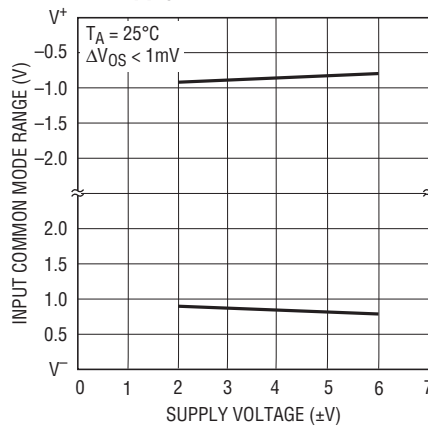

18189 G02

Input Bias Current vs Common Mode Voltage

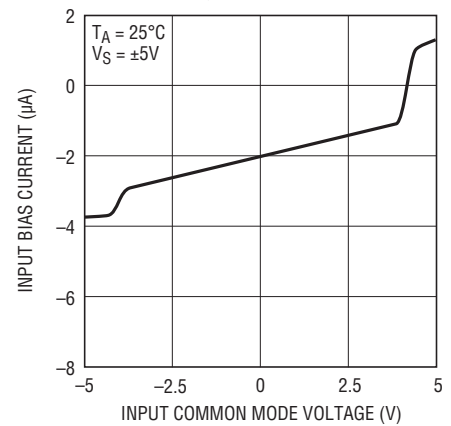

18189 G03

Input Bias Current vs Temperature

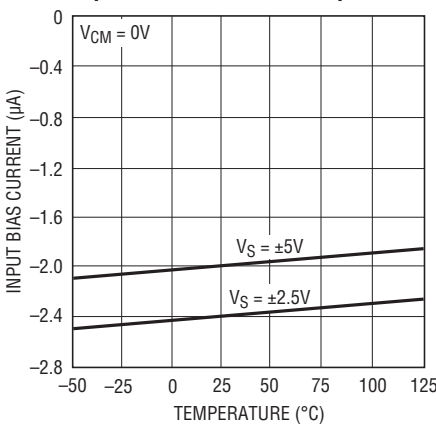

18189 G04

Input Noise Spectral Density

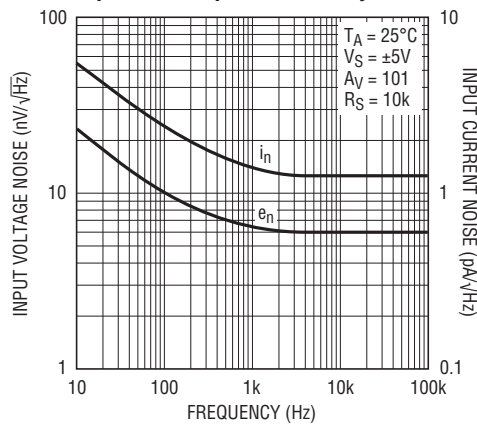

18189 G05

Open-Loop Gain vs Resistive Load

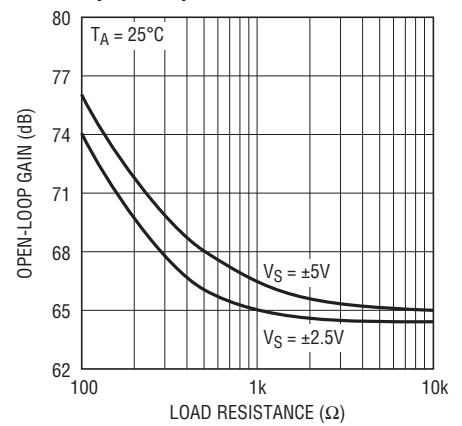

18189 G06

TYPICAL PERFORMANCE CHARACTERISTICS

Open-Loop Gain vs Temperature

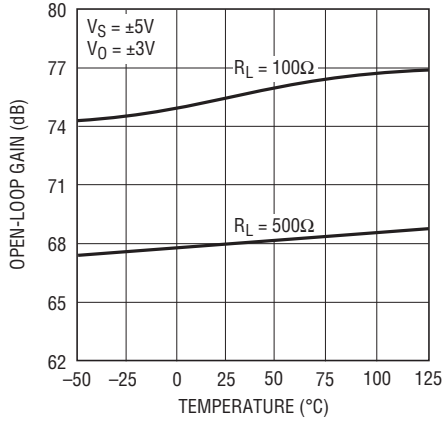

18189 G07

Output Voltage Swing vs Supply Voltage

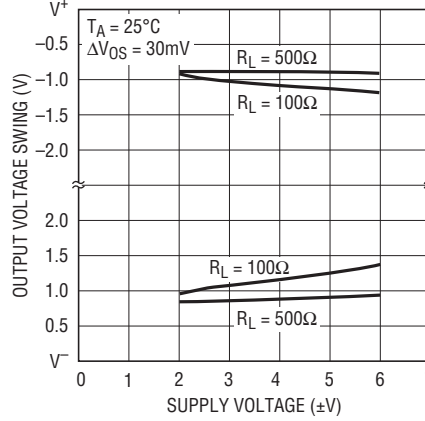

18189 G08

Output Voltage Swing vs Load Current

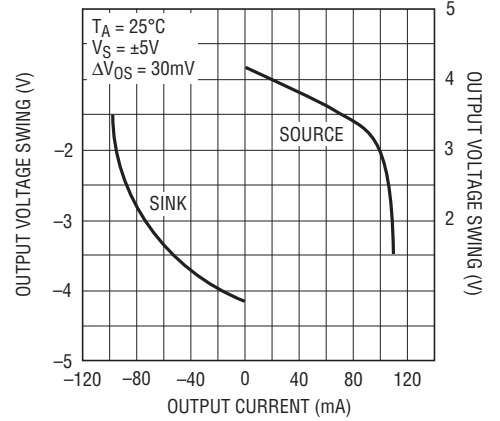

18189 G09

Output Short-Circuit Current vs Temperature

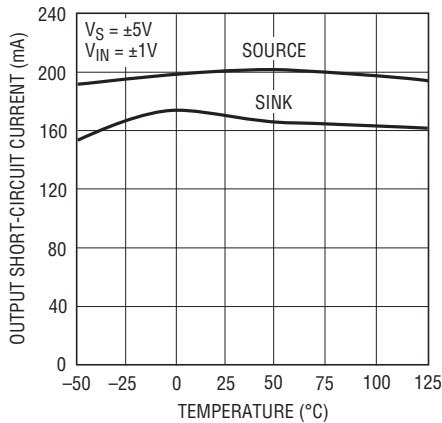

18189 G10

Output Current vs Temperature

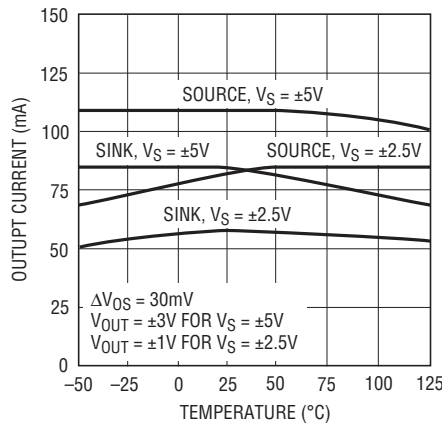

18189 G11

Output Impedance vs Frequency

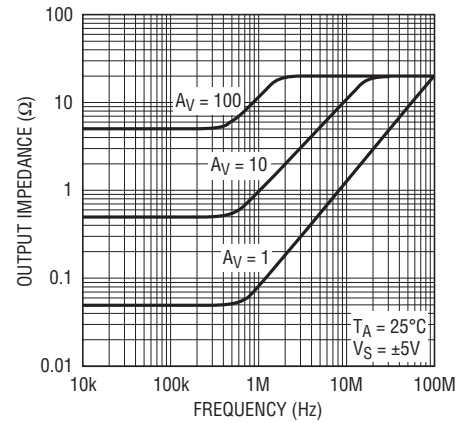

18189 G12

Gain and Phase vs Frequency

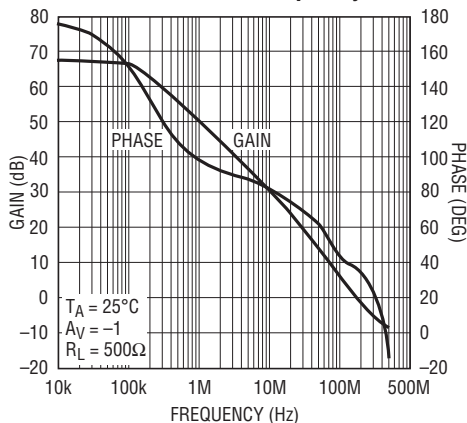

18189 G13

Gain Bandwidth and Phase Margin vs Temperature

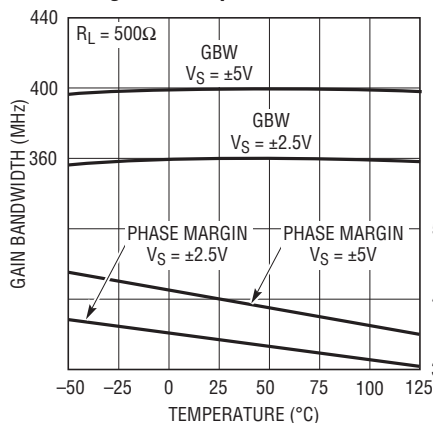

18189 G15

Gain vs Frequency, AV = 1

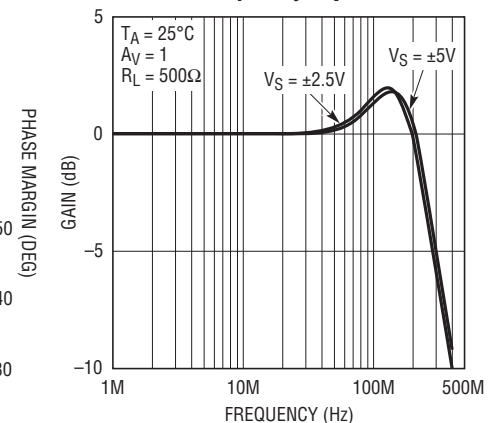

18189 G16

TYPICAL PERFORMANCE CHARACTERISTICS

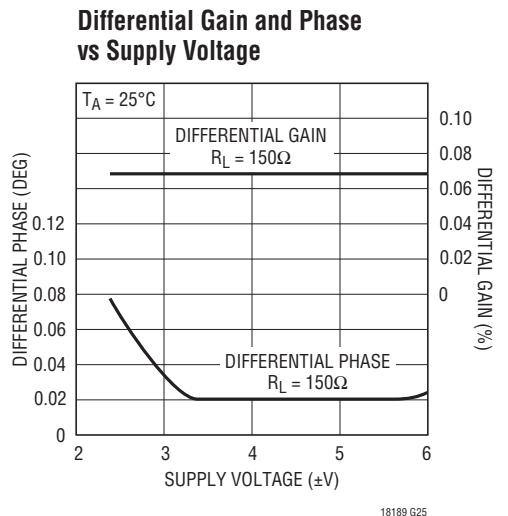
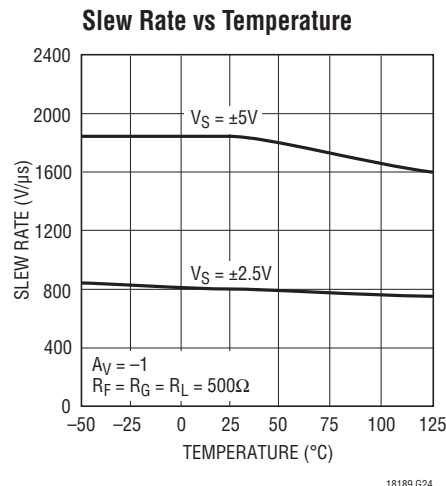
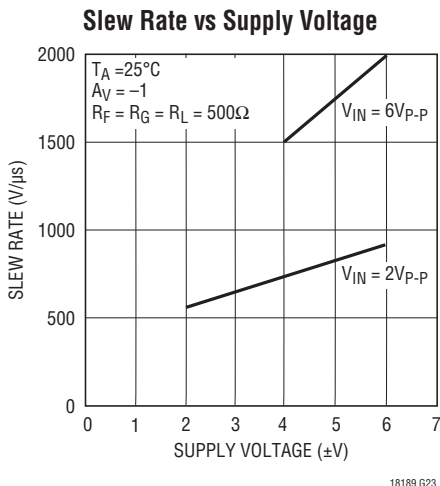
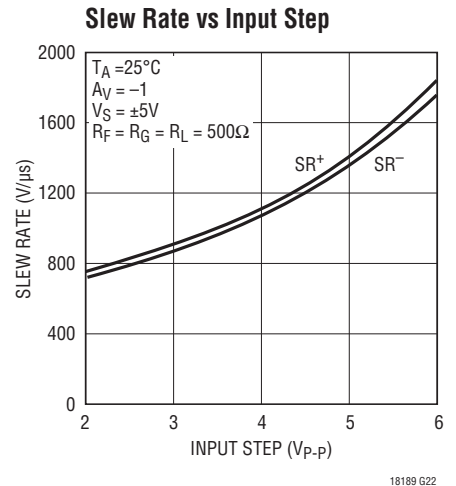
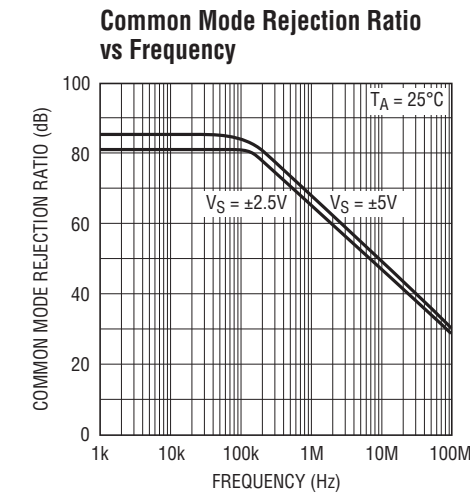
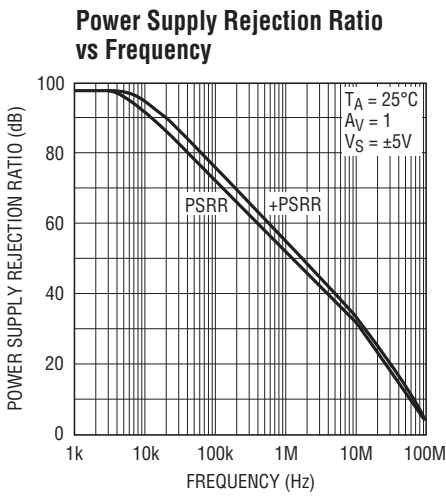
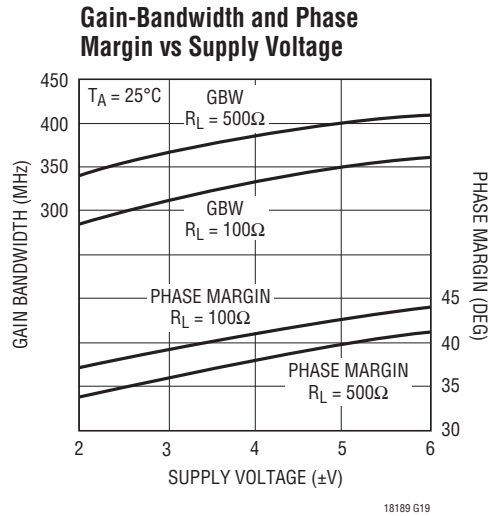
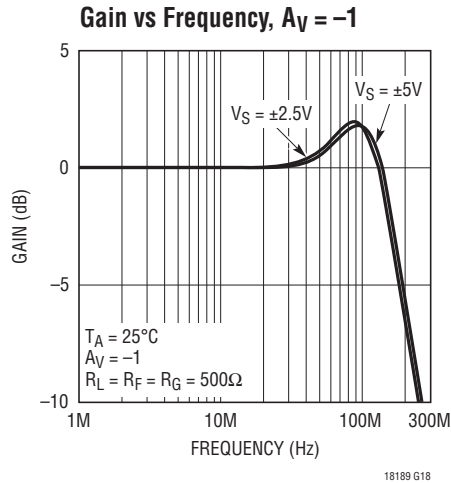
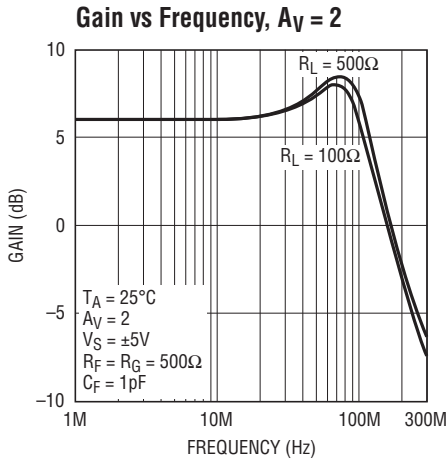

TYPICAL PERFORMANCE CHARACTERISTICS

Distortion vs Frequency, $A_V = 2$

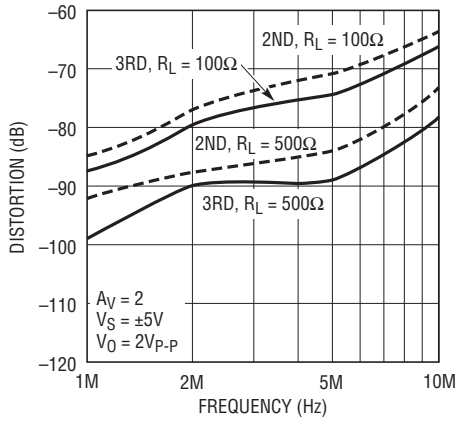

18189 G26

Distortion vs Frequency, $A_V = -1$

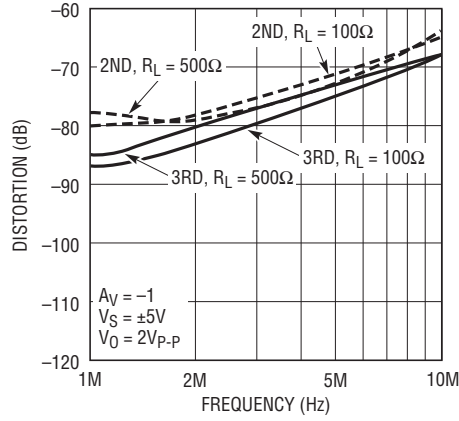

18189 G27

Distortion vs Frequency, $A_V = 1$

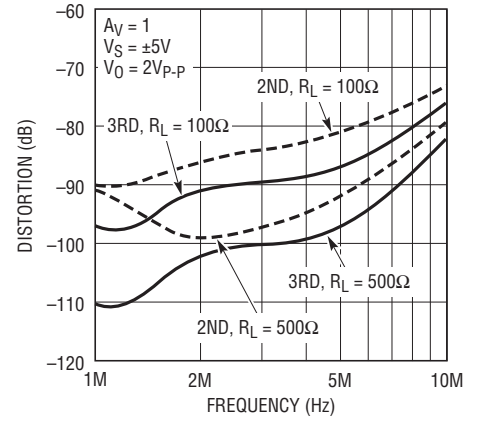

18189 G28

Channel Separation vs Frequency

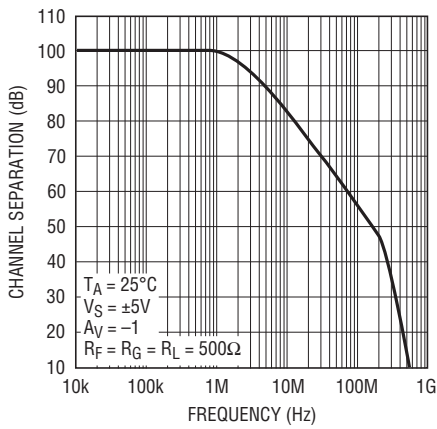

18188 G29

0.1% Settling Time

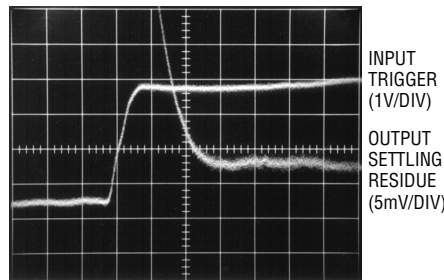

$V_S = \pm 5V$
 $V_{OUT} = \pm 2.5V$
 SETTLE TIME = 9ns
 $A_V = -1$
 $R_F = R_G = 500\Omega$
 $C_F = 4.1pF$

18189 G30

Small-Signal Transient, 20dB Gain

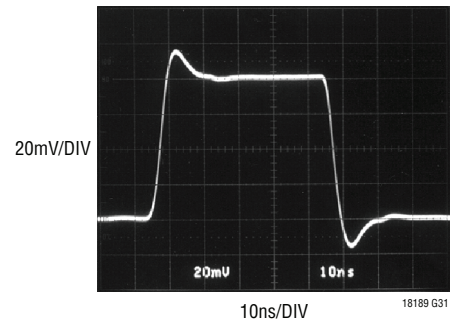

18189 G31

Large-Signal Transient, $A_V = -1$

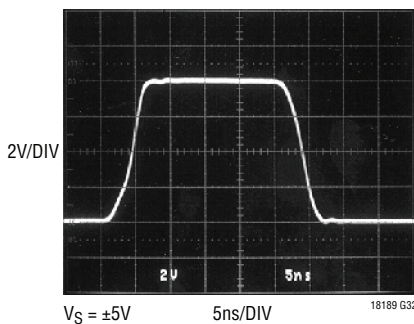

$V_S = \pm 5V$

18189 G32

Large-Signal Transient, $A_V = 1$

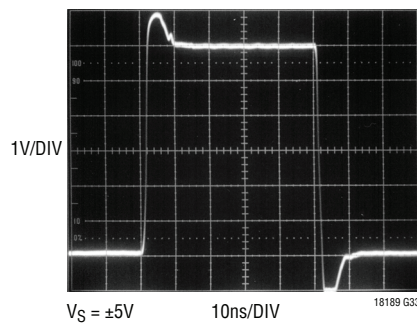

$V_S = \pm 5V$

18189 G33

Large-Signal Transient, $A_V = -1$

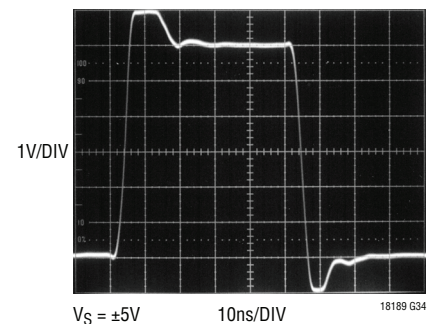

$V_S = \pm 5V$

18189 G34

APPLICATIONS INFORMATION

Layout and Passive Components

As with all high speed amplifiers, the LT1818/LT1819 require some attention to board layout. A ground plane is recommended and trace lengths should be minimized, especially on the negative input lead.

Low ESL/ESR bypass capacitors should be placed directly at the positive and negative supply (0.01μF ceramics are recommended). For high drive current applications, additional 1μF to 10μF tantalums should be added.

The parallel combination of the feedback resistor and gain setting resistor on the inverting input combine with the input capacitance to form a pole that can cause peaking or even oscillations. If feedback resistors greater than 500Ω are used, a parallel capacitor of value

$$C_F > R_G \cdot C_{IN}/R_F$$

should be used to cancel the input pole and optimize dynamic performance (see Figure 1). For applications where the DC noise gain is 1 and a large feedback resistor is used, C_F should be greater than or equal to C_{IN} . An example would be an I-to-V converter.

In high closed-loop gain configurations, $R_F \gg R_G$, no C_F needs to be added. To optimize the bandwidth in these applications, a capacitor, C_G , may be added in parallel with R_G in order to cancel out any parasitic C_F capacitance.

Capacitive Loading

The LT1818/LT1819 are optimized for low distortion and high gain bandwidth applications. The amplifiers can drive a capacitive load of 20pF in a unity-gain configuration and more with higher gain. When driving a larger capacitive

load, a resistor of 10Ω to 50Ω must be connected between the output and the capacitive load to avoid ringing or oscillation (see R_S in Figure 1). The feedback must still be taken directly from the output so that the series resistor will isolate the capacitive load to ensure stability.

Input Considerations

The inputs of the LT1818/LT1819 amplifiers are connected to the bases of NPN and PNP bipolar transistors in parallel. The base currents are of opposite polarity and provide first order bias current cancellation. Due to variation in the matching of NPN and PNP beta, the polarity of the input bias current can be positive or negative. The offset current, however, does not depend on beta matching and is tightly controlled. Therefore, the use of balanced source resistance at each input is recommended for applications where DC accuracy must be maximized. For example, with a 100Ω source resistance at each input, the 800nA maximum offset current results in only 80μV of extra offset, while without balance the 8μA maximum input bias current could result in an 0.8mV offset condition.

The inputs can withstand differential input voltages of up to 6V without damage and without needing clamping or series resistance for protection. This differential input voltage generates a large internal current (up to 50mA), which results in the high slew rate. In normal transient closed-loop operation, this does not increase power dissipation significantly because of the low duty cycle of the transient inputs. Sustained differential inputs, however, will result in excessive power dissipation and therefore **this device should not be used as a comparator.**

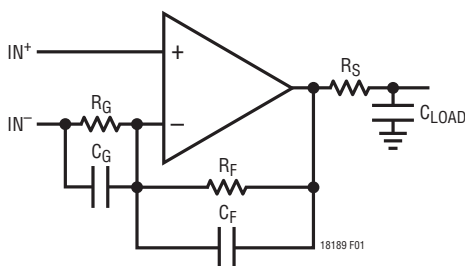

Figure 1

APPLICATIONS INFORMATION

Slew Rate

The slew rate of the LT1818/LT1819 is proportional to the differential input voltage. Highest slew rates are therefore seen in the lowest gain configurations. For example, a 6V output step with a gain of 10 has a 0.6V input step, whereas at unity gain there is a 6V input step. The LT1818/LT1819 is tested for slew rate at a gain of -1. Lower slew rates occur in higher gain configurations, whereas the highest slew rate (2500V/μs) occurs in a noninverting unity-gain configuration.

Power Dissipation

The LT1818/LT1819 combine high speed and large output drive in small packages. It is possible to exceed the maximum junction temperature specification (150°C) under certain conditions. Maximum junction temperature (T_J) is calculated from the ambient temperature (T_A), power dissipation per amplifier (P_D) and number of amplifiers (n) as follows:

$$T_J = T_A + (n \cdot P_D \cdot \theta_{JA})$$

Power dissipation is composed of two parts. The first is due to the quiescent supply current and the second is due to on-chip dissipation caused by the load current. The worst-case load-induced power occurs when the output voltage is at 1/2 of either supply voltage (or the maximum swing if less than 1/2 the supply voltage). Therefore $P_{D\text{MAX}}$ is:

$$P_{D\text{MAX}} = (V^+ - V^-) \cdot (I_{S\text{MAX}}) + (V^+ / 2)^2 / R_L \text{ or}$$

$$P_{D\text{MAX}} = (V^+ - V^-) \cdot (I_{S\text{MAX}}) + (V^+ - V_{O\text{MAX}}) \cdot (V_{O\text{MAX}} / R_L)$$

Example: LT1819IS8 at 85°C, $V_S = \pm 5V$, $R_L = 100\Omega$

$$P_{D\text{MAX}} = (10V) \cdot (14mA) + (2.5V)^2 / 100\Omega = 202.5mW$$

$$T_{J\text{MAX}} = 85^\circ\text{C} + (2 \cdot 202.5mW) \cdot (150^\circ\text{C/W}) = 146^\circ\text{C}$$

Circuit Operation

The LT1818/LT1819 circuit topology is a true voltage feedback amplifier that has the slewing behavior of a current feedback amplifier. The operation of the circuit can be understood by referring to the Simplified Schematic. Complementary NPN and PNP emitter followers buffer the inputs and drive an internal resistor. The input voltage appears across the resistor, generating a current that is mirrored into the high impedance node.

Complementary followers form an output stage that buffer the gain node from the load. The input resistor, input stage transconductance and the capacitor on the high impedance node determine the bandwidth. The slew rate is determined by the current available to charge the gain node capacitance. This current is the differential input voltage divided by R_1 , so the slew rate is proportional to the input step. Highest slew rates are therefore seen in the lowest gain configurations.

TYPICAL APPLICATION

Single Supply Differential ADC Driver

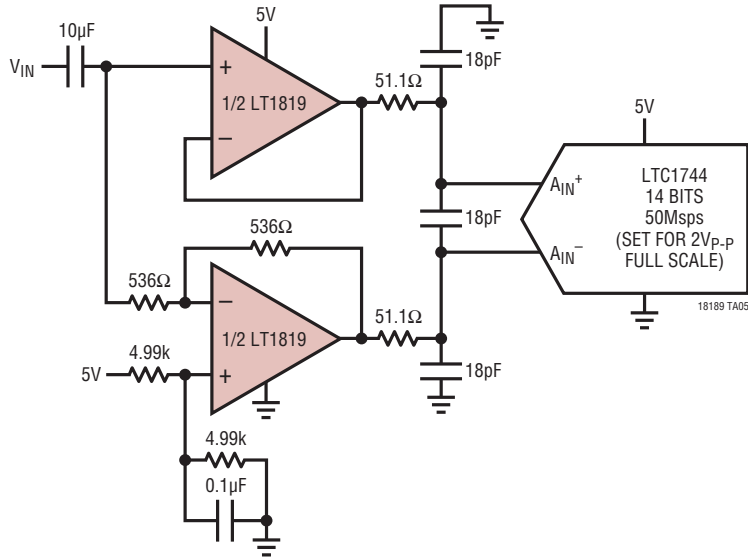

**Results Obtained with the Circuit of Figure 2 at 5MHz.
FFT Shows 81dB Overall Spurious Free Dynamic Range**

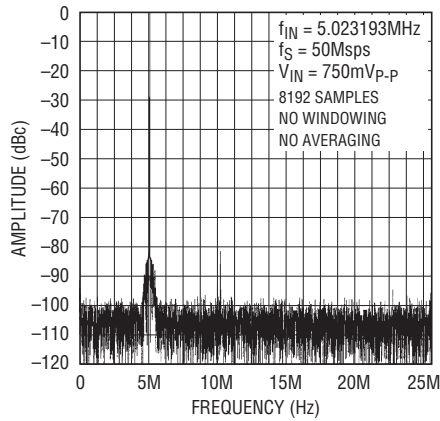

18189 TA06

SIMPLIFIED SCHEMATIC (One Amplifier)

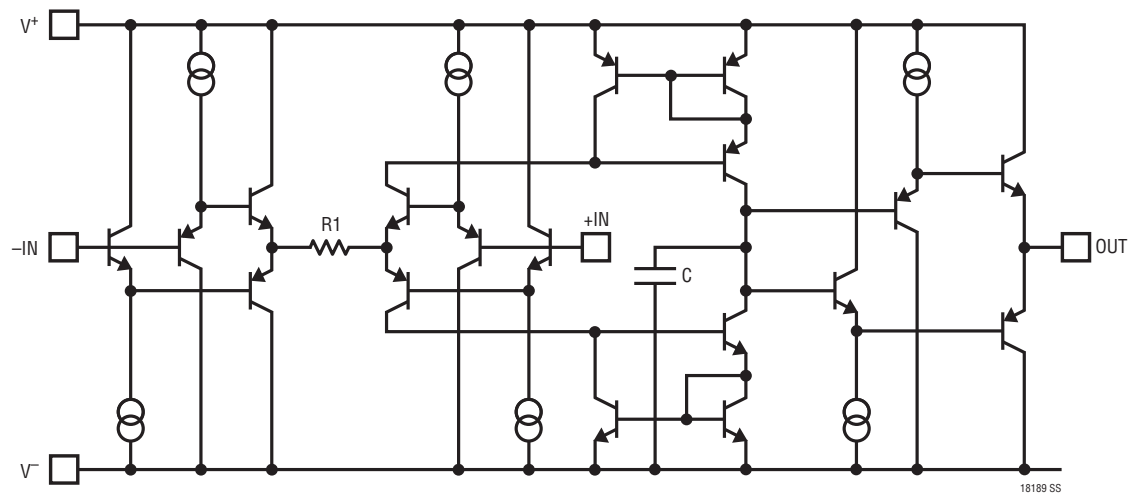

PACKAGE DESCRIPTION

**MS8 Package
8-Lead Plastic MSOP**

(Reference LTC DWG # 05-08-1660 Rev F)

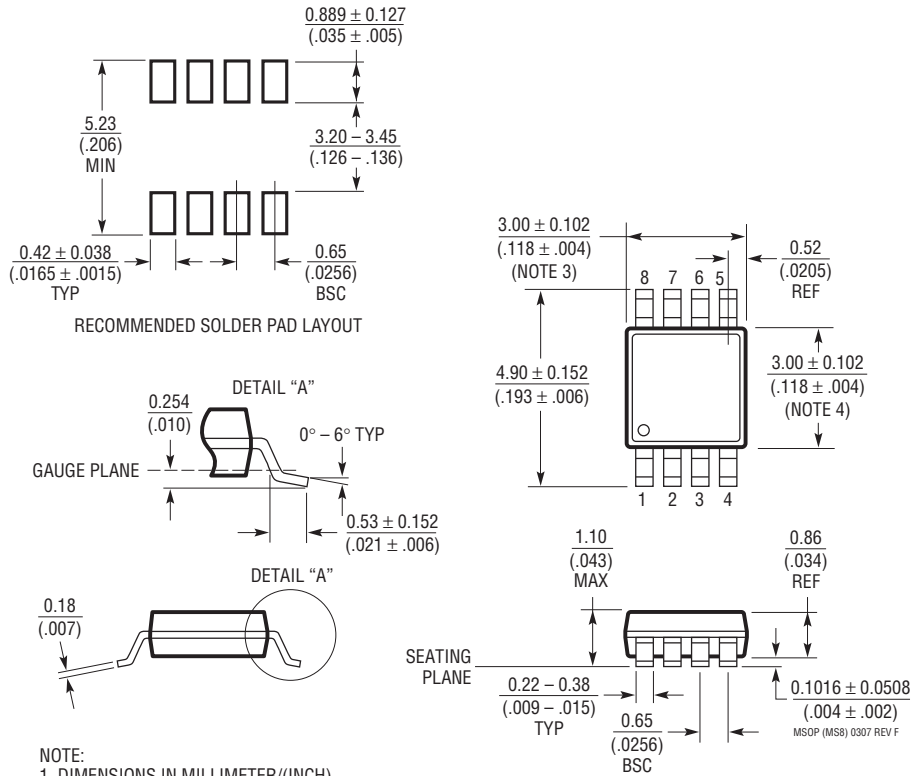

- NOTE:
1. DIMENSIONS IN MILLIMETER/(INCH)
 2. DRAWING NOT TO SCALE
 3. DIMENSION DOES NOT INCLUDE MOLD FLASH, PROTRUSIONS OR GATE BURRS.
MOLD FLASH, PROTRUSIONS OR GATE BURRS SHALL NOT EXCEED 0.152mm (.006") PER SIDE
 4. DIMENSION DOES NOT INCLUDE INTERLEAD FLASH OR PROTRUSIONS.
INTERLEAD FLASH OR PROTRUSIONS SHALL NOT EXCEED 0.152mm (.006") PER SIDE
 5. LEAD COPLANARITY (BOTTOM OF LEADS AFTER FORMING) SHALL BE 0.102mm (.004") MAX

PACKAGE DESCRIPTION

S5 Package
5-Lead Plastic TSOT-23
 (Reference LTC DWG # 05-08-1635)

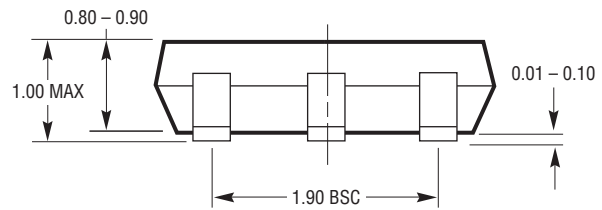
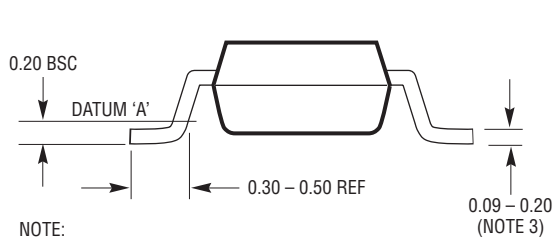
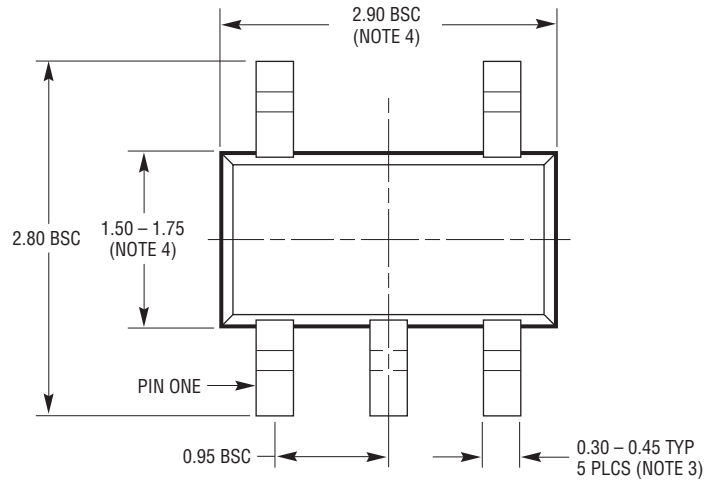
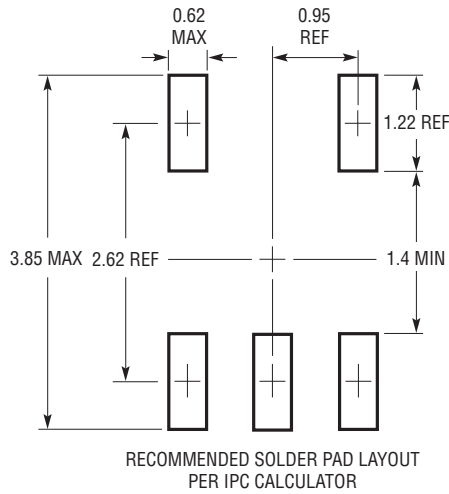

- NOTE:
1. DIMENSIONS ARE IN MILLIMETERS
 2. DRAWING NOT TO SCALE
 3. DIMENSIONS ARE INCLUSIVE OF PLATING
 4. DIMENSIONS ARE EXCLUSIVE OF MOLD FLASH AND METAL BURR
 5. MOLD FLASH SHALL NOT EXCEED 0.254mm
 6. JEDEC PACKAGE REFERENCE IS MO-193

S5 TSOT-23 0302 REV B

PACKAGE DESCRIPTION

S8 Package
8-Lead Plastic Small Outline (Narrow .150 Inch)
 (Reference LTC DWG # 05-08-1610)

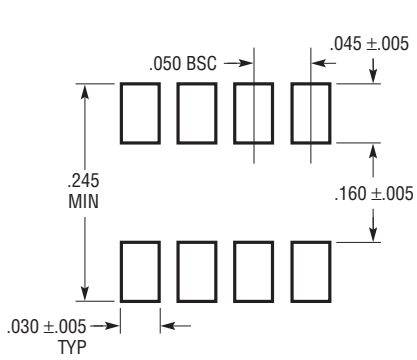

RECOMMENDED SOLDER PAD LAYOUT

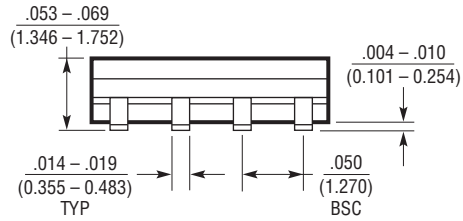
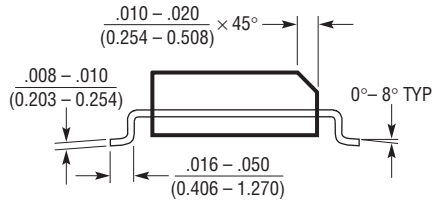
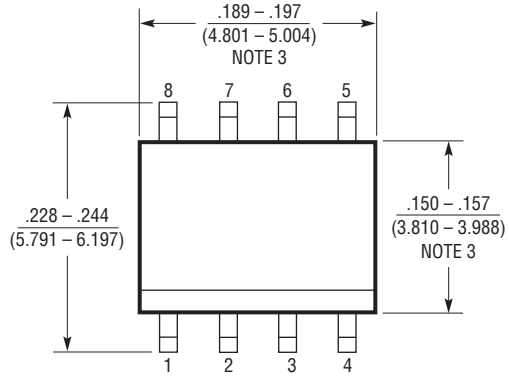

- NOTE:
 1. DIMENSIONS IN $\frac{\text{INCHES}}{\text{MILLIMETERS}}$
 2. DRAWING NOT TO SCALE
 3. THESE DIMENSIONS DO NOT INCLUDE MOLD FLASH OR PROTRUSIONS.
 MOLD FLASH OR PROTRUSIONS SHALL NOT EXCEED .006" (0.15mm)

S08 0303

REVISION HISTORY (Revision history begins at Rev B)

REV	DATE	DESCRIPTION	PAGE NUMBER
B	5/10	Updated Order Information Section	2

TYPICAL APPLICATION

80MHz, 20dB Gain Block

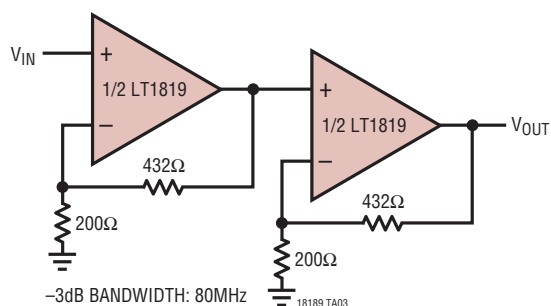

20dB Gain Block Frequency Response

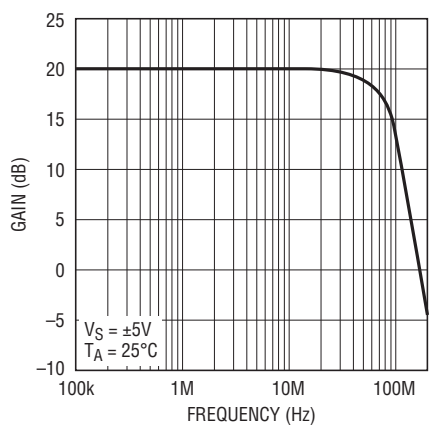

18189 TA04

Large-Signal Transient Response

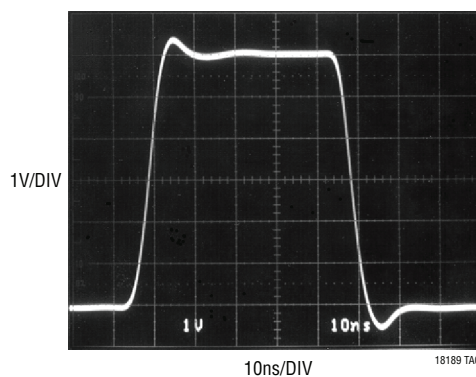

18189 TA07

RELATED PARTS

PART NUMBER	DESCRIPTION	COMMENTS
LT1395/LT1396/LT1397	Single/Dual/Quad 400MHz Current Feedback Amplifiers	4.6mA Supply Current
LT1806/LT1807	Single/Dual 325MHz, 140V/μs Rail-to-Rail I/O Op Amps	Low Noise: 3.5nV/√Hz
LT1809/LT1810	Single/Dual 180MHz, 350V/μs Rail-to-Rail I/O Op Amps	Low Distortion: -90dBc at 5MHz
LT1812/LT1813/LT1814	Single/Dual/Quad 100MHz, 750V/μs Op Amps	Low Power: 3.6mA Max at ±5V
LT1815/LT1816/LT1817	Single/Dual/Quad 220MHz, 1500V/μs Op Amps	Programmable Supply Current
LT6203/LT6204	Dual/Quad 100MHz, Rail-to-Rail I/O Op Amps	1.9nV/√Hz Noise, 3mA Max

Looking for pricing, stock, or lifecycle information?

Click below to explore more details on WIN SOURCE:

 [View LT1819CS8#TRPBF on WIN SOURCE](#)

 [Analog Devices Inc. Information](#)

Optimize Your Supply Chain with WIN SOURCE Solutions

-  Global Sourcing Solution
-  Obsolete Management
-  Cost Control Management
-  Shortage Management
-  Alternative Solution
-  Excess Inventory Management