



**THE DATASHEET OF  
LT3014BIDD#TRPBF**



# 20mA, 3V to 80V Low Dropout Micropower Linear Regulator

## FEATURES

- **Wide Input Voltage Range: 3V to 80V**
- **Low Quiescent Current: 7 $\mu$ A**
- **Low Dropout Voltage: 350mV**
- **Output Current: 20mA**
- LT3014BHV Survives 100V Transients (2ms)
- No Protection Diodes Needed
- Adjustable Output from 1.22V to 60V
- Stable with 0.47 $\mu$ F Output Capacitor
- Stable with Aluminum, Tantalum or Ceramic Capacitors
- Reverse-Battery Protection
- No Reverse Current Flow from Output
- Thermal Limiting
- Available in 5-Lead ThinSOT™ and 8-Lead DFN Packages

## APPLICATIONS

- Low Current High Voltage Regulators
- Regulator for Battery-Powered Systems
- Telecom Applications
- Automotive Applications

## DESCRIPTION

The **LT<sup>®</sup>3014B** is a high voltage, micropower low dropout-linear regulator. The device is capable of supplying 20mA of output current with a dropout voltage of 350mV. Designed for use in battery-powered or high voltage systems, the low quiescent current (7 $\mu$ A operating) makes the LT3014B an ideal choice. Quiescent current is also well controlled in dropout.

Other features of the LT3014B include the ability to operate with very small output capacitors. The regulators are stable with only 0.47 $\mu$ F on the output while most older devices require between 10 $\mu$ F and 100 $\mu$ F for stability. Small ceramic capacitors can be used without the necessary addition of ESR as is common with other regulators. Internal protection circuitry includes reverse-battery protection, current limiting, thermal limiting and reverse current protection.

The device is available as an adjustable device with a 1.22V reference voltage. The LT3014B regulator is available in the 5-lead ThinSOT and 8-lead DFN packages.

LT, LT, LTC and LTM are registered trademarks of Linear Technology Corporation. ThinSOT is a trademark of Linear Technology Corporation. All other trademarks are the property of their respective owners. Protected by U.S. Patents including 6118263, 6144250.

## TYPICAL APPLICATION

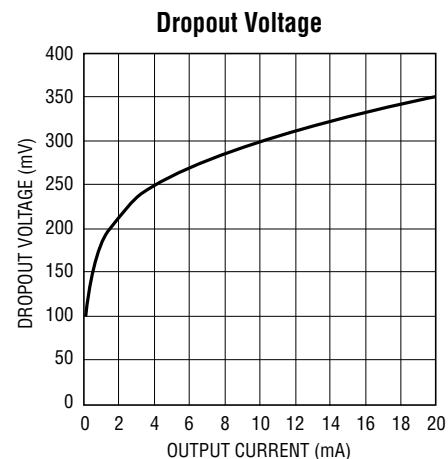
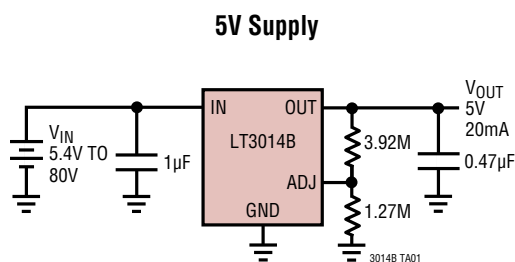

3014B TA02

# LT3014B

## ABSOLUTE MAXIMUM RATINGS (Note 1)

IN Pin Voltage, Operating.....	±80V	Storage Temperature Range	
Transient (2ms Survival, LT3014BHV) .....	+100V	ThinSOT Package.....	–65°C to 150°C
OUT Pin Voltage.....	±60V	DFN Package.....	–65°C to 125°C
IN to OUT Differential Voltage .....	±80V	Operating Junction Temperature Range (Notes 3, 9, 10)	
ADJ Pin Voltage .....	±7V	E-Grade, I-Grade .....	–40°C to 125°C
Output Short-Circuit Duration .....	Indefinite	MP-Grade.....	–55°C to 125°C
		Lead Temperature (Soldering, 10 sec)	
		SOT-23 Package.....	300°C

## PIN CONFIGURATION

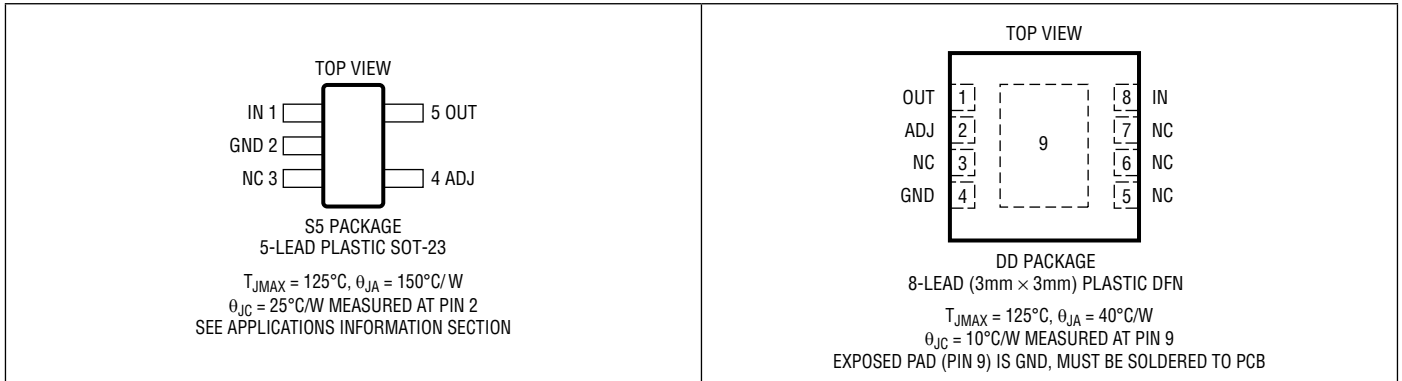

## ORDER INFORMATION

LEAD FREE FINISH	TAPE AND REEL	PART MARKING*	PACKAGE DESCRIPTION	TEMPERATURE RANGE
LT3014BES5#PBF	LT3014BES5#TRPBF	LTCHK	5-Lead Plastic SOT-23	-40°C to 125°C
LT3014BIS5#PBF	LT3014BIS5#TRPBF	LTCHK	5-Lead Plastic SOT-23	-40°C to 125°C
LT3014BMPS5#PBF	LT3014BMPS5#TRPBF	LTCHK	5-Lead Plastic SOT-23	-55°C to 125°C
LT3014BHVES5#PBF	LT3014BHVES5#TRPBF	LTCHN	5-Lead Plastic SOT-23	-40°C to 125°C
LT3014BHVIS5#PBF	LT3014BHVIS5#TRPBF	LTCHN	5-Lead Plastic SOT-23	-40°C to 125°C
LT3014BEDD#PBF	LT3014BEDD#TRPBF	LCHM	8-Lead (3mm × 3mm) Plastic DFN	-40°C to 125°C
LT3014BIDD#PBF	LT3014BIDD#TRPBF	LCHM	8-Lead (3mm × 3mm) Plastic DFN	-40°C to 125°C
LT3014BHVEDD#PBF	LT3014BHVEDD#TRPBF	LCHP	8-Lead (3mm × 3mm) Plastic DFN	-40°C to 125°C
LT3014BHVIDD#PBF	LT3014BHVIDD#TRPBF	LCHP	8-Lead (3mm × 3mm) Plastic DFN	-40°C to 125°C
LEAD BASED FINISH	TAPE AND REEL	PART MARKING*	PACKAGE DESCRIPTION	TEMPERATURE RANGE
LT3014BES5	LT3014BES5#TR	LTCHK	5-Lead Plastic SOT-23	-40°C to 125°C
LT3014BIS5	LT3014BIS5#TR	LTCHK	5-Lead Plastic SOT-23	-40°C to 125°C
LT3014BMPS5	LT3014BMPS5#TR	LTCHK	5-Lead Plastic SOT-23	-55°C to 125°C
LT3014BHVES5	LT3014BHVES5#TR	LTCHN	5-Lead Plastic SOT-23	-40°C to 125°C
LT3014BHVIS5	LT3014BHVIS5#TR	LTCHN	5-Lead Plastic SOT-23	-40°C to 125°C
LT3014BEDD	LT3014BEDD#TR	LCHM	8-Lead (3mm × 3mm) Plastic DFN	-40°C to 125°C
LT3014BIDD	LT3014BIDD#TR	LCHM	8-Lead (3mm × 3mm) Plastic DFN	-40°C to 125°C
LT3014BHVEDD	LT3014BHVEDD#TR	LCHP	8-Lead (3mm × 3mm) Plastic DFN	-40°C to 125°C
LT3014BHVIDD	LT3014BHVIDD#TR	LCHP	8-Lead (3mm × 3mm) Plastic DFN	-40°C to 125°C

Consult LTC Marketing for parts specified with wider operating temperature ranges. \*The temperature grade is identified by a label on the shipping container.

For more information on lead free part marking, go to: <http://www.linear.com/leadfree/>

This product is only offered in trays. For more information go to: <http://www.linear.com/packaging/>

# LT3014B

## ELECTRICAL CHARACTERISTICS

The ● denotes the specifications which apply over the full operating temperature range, otherwise specifications are at  $T_J = 25^\circ\text{C}$ .

SYMBOL	CONDITIONS		MIN	TYP	MAX	UNITS
Minimum Input Voltage	$I_{LOAD} = 20\text{mA}$	●		3	3.3	V
ADJ Pin Voltage (Notes 2, 3)	$V_{IN} = 3.3\text{V}$ , $I_{LOAD} = 100\mu\text{A}$ $3.3\text{V} < V_{IN} < 80\text{V}$ , $100\mu\text{A} < I_{LOAD} < 20\text{mA}$	●	1.200	1.220	1.240	V
Line Regulation	$\Delta V_{IN} = 3.3\text{V}$ to $80\text{V}$ , $I_{LOAD} = 100\mu\text{A}$ (Note 2)	●		1	10	mV
Load Regulation	$V_{IN} = 3.3\text{V}$ , $\Delta I_{LOAD} = 100\mu\text{A}$ to $20\text{mA}$ (Note 2) $V_{IN} = 3.3\text{V}$ , $\Delta I_{LOAD} = 100\mu\text{A}$ to $20\text{mA}$	●		13	25	mV
Dropout Voltage $V_{IN} = V_{OUT(NOMINAL)}$ (Notes 4, 5)	$I_{LOAD} = 100\mu\text{A}$	●		120	180	mV
	$I_{LOAD} = 100\mu\text{A}$	●			250	mV
	$I_{LOAD} = 1\text{mA}$ $I_{LOAD} = 1\text{mA}$	●		200	270	mV
	$I_{LOAD} = 1\text{mA}$ $I_{LOAD} = 1\text{mA}$	●			360	mV
GND Pin Current $V_{IN} = V_{OUT(NOMINAL)}$ (Notes 4, 6)	$I_{LOAD} = 10\text{mA}$ $I_{LOAD} = 10\text{mA}$	●		300	350	mV
	$I_{LOAD} = 10\text{mA}$ $I_{LOAD} = 10\text{mA}$	●			450	mV
	$I_{LOAD} = 20\text{mA}$ $I_{LOAD} = 20\text{mA}$	●		350	410	mV
	$I_{LOAD} = 20\text{mA}$ $I_{LOAD} = 20\text{mA}$	●			570	mV
Output Voltage Noise	$I_{LOAD} = 0\text{mA}$	●		7	20	$\mu\text{A}$
	$I_{LOAD} = 100\mu\text{A}$	●		12	30	$\mu\text{A}$
	$I_{LOAD} = 1\text{mA}$	●		40	100	$\mu\text{A}$
	$I_{LOAD} = 10\text{mA}$	●		250	450	$\mu\text{A}$
	$I_{LOAD} = 20\text{mA}$	●		650	1000	$\mu\text{A}$
Output Voltage Noise	$C_{OUT} = 0.47\mu\text{F}$ , $I_{LOAD} = 20\text{mA}$ , $\text{BW} = 10\text{Hz}$ to $100\text{kHz}$			115		$\mu\text{V}_{\text{RMS}}$
ADJ Pin Bias Current	(Note 7)			4	10	nA
Ripple Rejection	$V_{IN} = 7\text{V}$ (Avg), $V_{\text{RIPPLE}} = 0.5\text{V}_{\text{P-P}}$ , $f_{\text{RIPPLE}} = 120\text{Hz}$ , $I_{LOAD} = 20\text{mA}$		60	70		dB
Current Limit	$V_{IN} = 7\text{V}$ , $V_{OUT} = 0\text{V}$			70		mA
	$V_{IN} = 3.3\text{V}$ , $\Delta V_{OUT} = -0.1\text{V}$ (Note 2)	●	25			mA
Input Reverse Leakage Current	$V_{IN} = -80\text{V}$ , $V_{OUT} = 0\text{V}$	●			6	mA
Reverse Output Current (Note 8)	$V_{OUT} = 1.22\text{V}$ , $V_{IN} < 1.22\text{V}$ (Note 2)			2	4	$\mu\text{A}$

**Note 1:** Stresses beyond those listed under Absolute Maximum Ratings may cause permanent damage to the device. Exposure to any Absolute Maximum Rating condition for extended periods may affect device reliability and lifetime.

**Note 2:** The LT3014B is tested and specified for these conditions with the ADJ pin connected to the OUT pin.

**Note 3:** Operating conditions are limited by maximum junction temperature. The regulated output voltage specification will not apply for all possible combinations of input voltage and output current. When operating at maximum input voltage, the output current range must be limited. When operating at maximum output current, the input voltage range must be limited.

**Note 4:** To satisfy requirements for minimum input voltage, the LT3014B is tested and specified for these conditions with an external resistor divider (249k bottom, 392k top) for an output voltage of 3.3V. The external resistor divider adds a 5 $\mu\text{A}$  DC load on the output.

**Note 5:** Dropout voltage is the minimum input to output voltage differential needed to maintain regulation at a specified output current. In dropout, the output voltage is equal to  $(V_{IN} - V_{\text{DROPOUT}})$ .

**Note 6:** GND pin current is tested with  $V_{IN} = V_{OUT}$  (nominal) and a current source load. This means the device is tested while operating in its dropout region. This is the worst-case GND pin current. The GND pin current decreases slightly at higher input voltages.

**Note 7:** ADJ pin bias current flows into the ADJ pin.

**Note 8:** Reverse output current is tested with the IN pin grounded and the OUT pin forced to the rated output voltage. This current flows into the OUT pin and out of the GND pin.

**Note 9:** The LT3014B is tested and specified under pulse load conditions such that  $T_J \cong T_A$ . The LT3014BE is 100% tested at  $T_A = 25^\circ\text{C}$ . Performance at  $-40^\circ\text{C}$  to  $125^\circ\text{C}$  is assured by design, characterization, and statistical process controls. The LT3014BI is guaranteed over the full  $-40^\circ\text{C}$  to  $125^\circ\text{C}$  operating junction temperature range. The LT3014BMP is 100% tested and guaranteed over the  $-55^\circ\text{C}$  to  $125^\circ\text{C}$  operating junction temperature range.

**Note 10:** This IC includes overtemperature protection that is intended to protect the device during momentary overload conditions. Junction temperature will exceed  $125^\circ\text{C}$  when overtemperature protection is active. Continuous operation above the specified maximum operating junction temperature may impair device reliability.

# TYPICAL PERFORMANCE CHARACTERISTICS

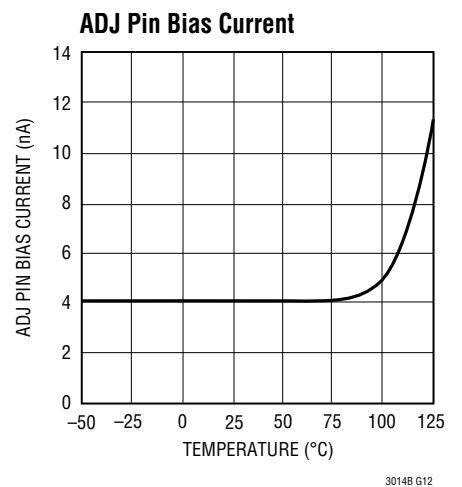
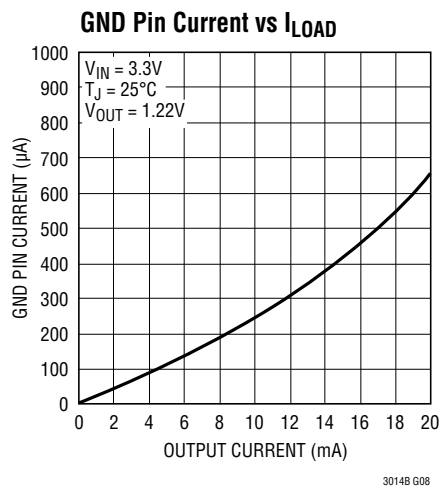
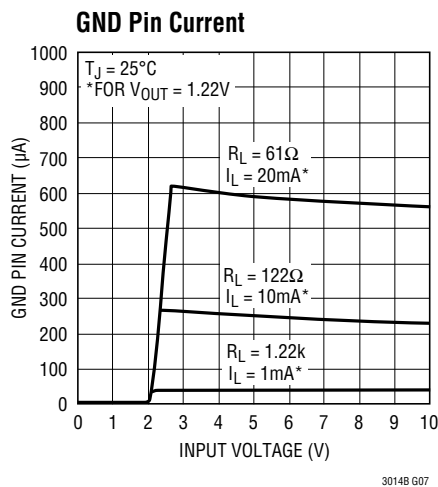
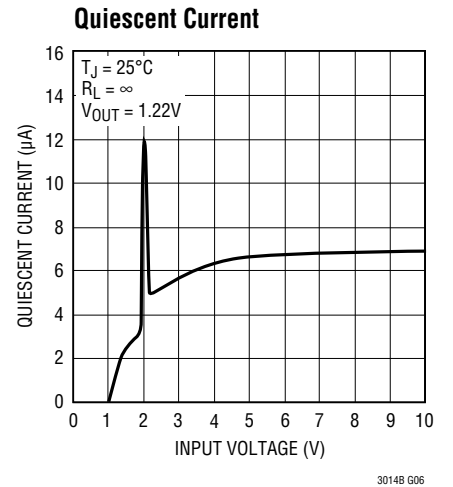
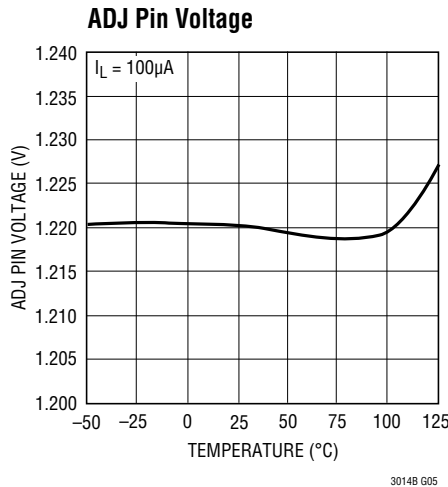
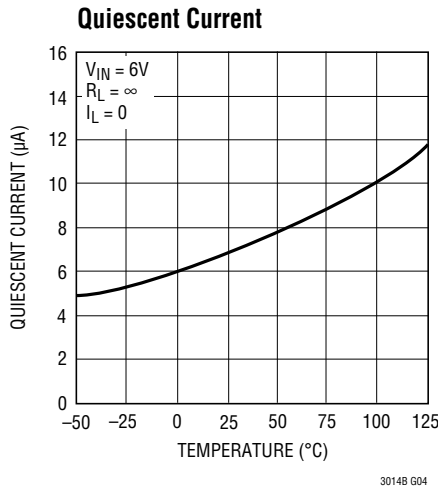
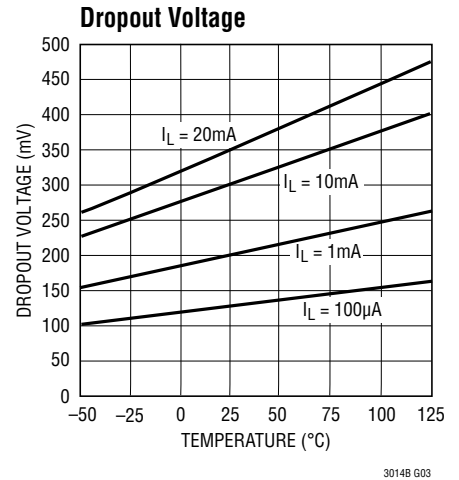
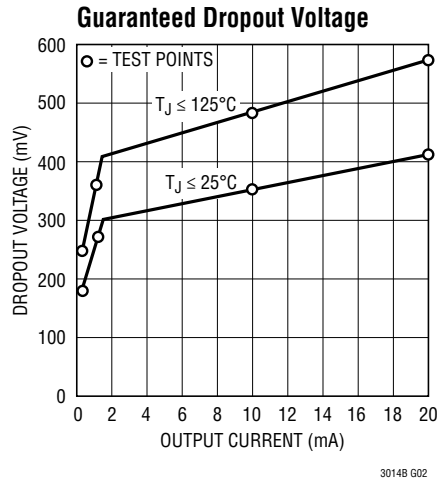
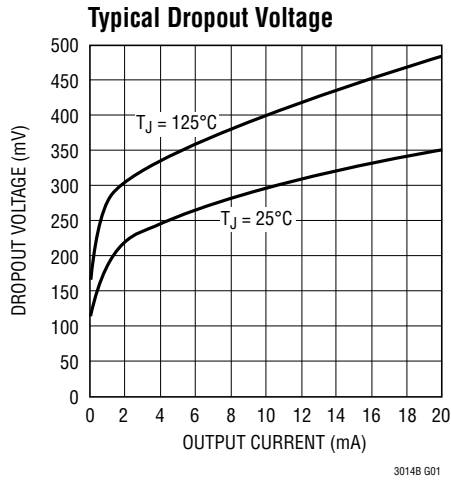

## TYPICAL PERFORMANCE CHARACTERISTICS

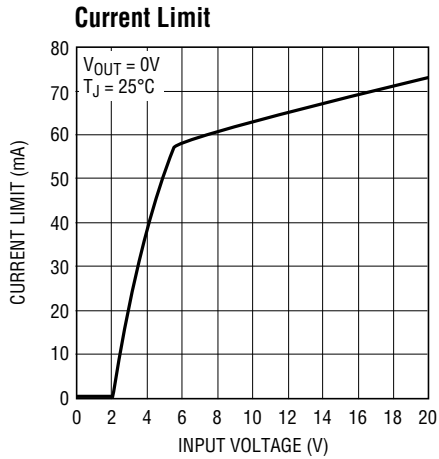

3014B G13

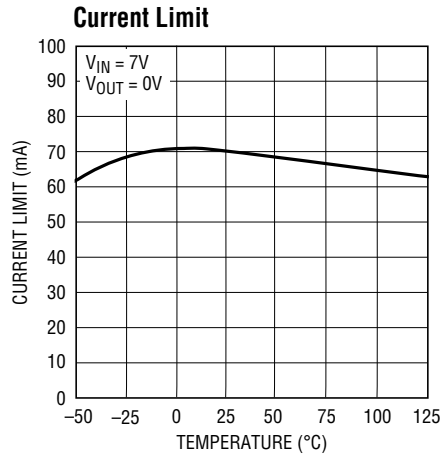

3014B G14

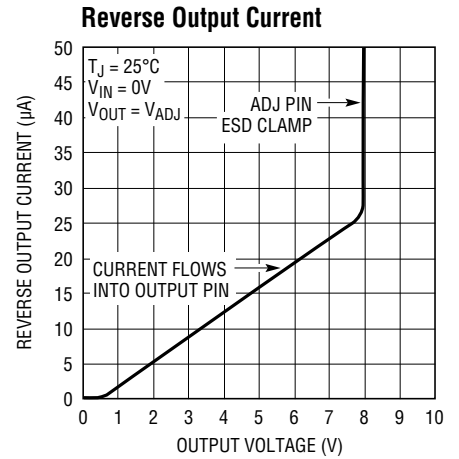

3014B G15

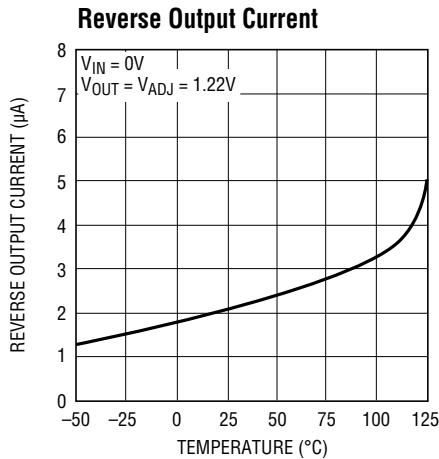

3014B G16

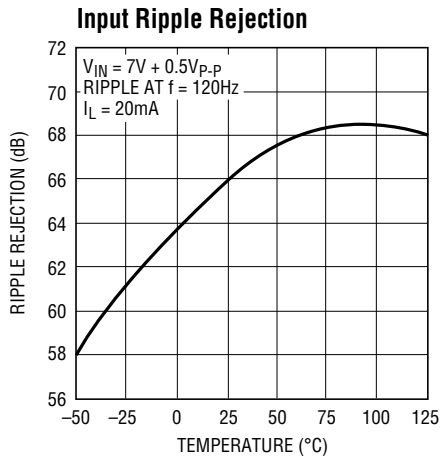

3014B G17

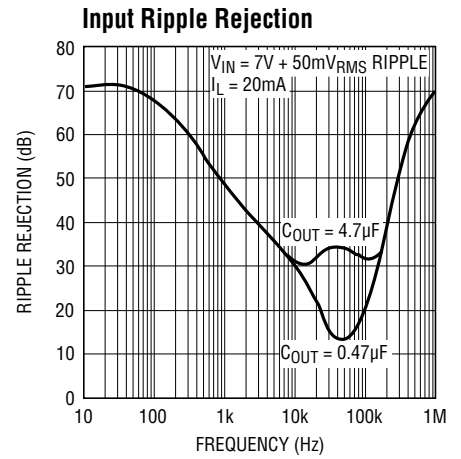

3014B G18

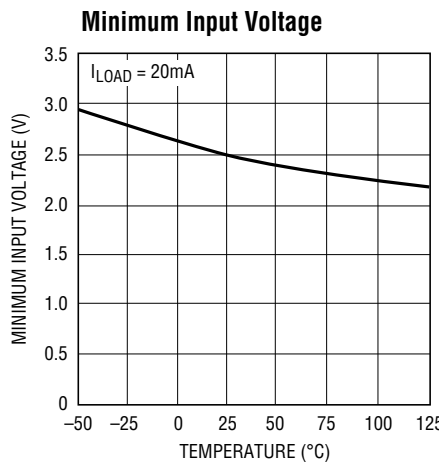

3014B G19

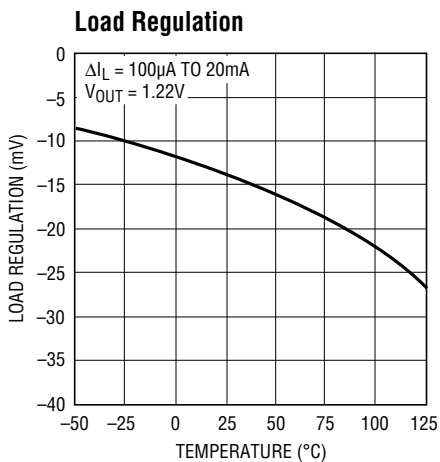

3014B G20

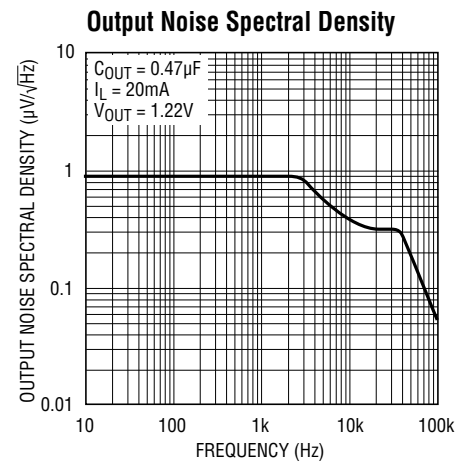

3014B G21

## TYPICAL PERFORMANCE CHARACTERISTICS

### 10Hz to 100kHz Output Noise

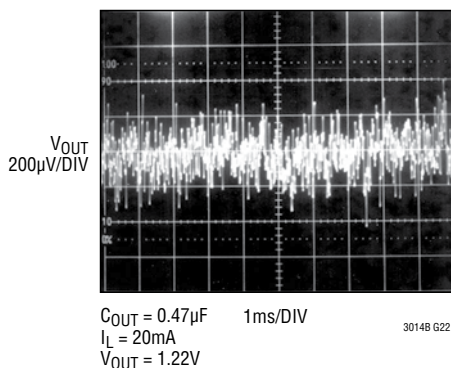

### Transient Response

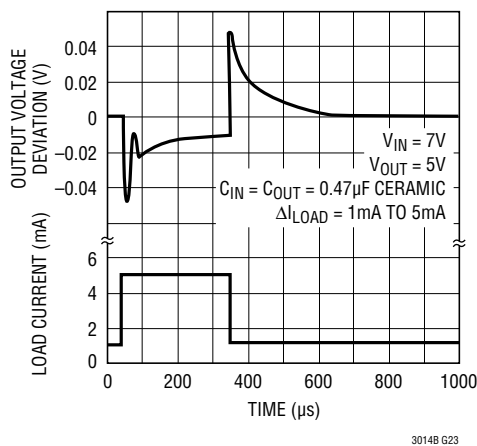

## PIN FUNCTIONS (SOT-23 Package/DD Package)

**IN (Pin 1/Pin 8):** Input. Power is supplied to the device through the IN pin. A bypass capacitor is required on this pin if the device is more than six inches away from the main input filter capacitor. In general, the output impedance of a battery rises with frequency, so it is advisable to include a bypass capacitor in battery-powered circuits. A bypass capacitor in the range of  $0.1\mu\text{F}$  to  $10\mu\text{F}$  is sufficient. The LT3014B is designed to withstand reverse voltages on the IN pin with respect to ground and the OUT pin. In the case of a reversed input, which can happen if a battery is plugged in backwards, the LT3014B will act as if there is a diode in series with its input. There will be no reverse current flow into the LT3014B and no reverse voltage will appear at the load. The device will protect both itself and the load.

**GND (Pin 2/Pins 4, 9):** Ground.

**ADJ (Pin 4/Pin 2):** Adjust. This is the input to the error amplifier. This pin is internally clamped to  $\pm 7\text{V}$ . It has a bias current of  $4\text{nA}$  which flows into the pin (see curve of ADJ Pin Bias Current vs Temperature in the Typical Performance Characteristics). The ADJ pin voltage is  $1.22\text{V}$  referenced to ground, and the output voltage range is  $1.22\text{V}$  to  $60\text{V}$ .

**OUT (Pin 5/Pin 1):** Output. The output supplies power to the load. A minimum output capacitor of  $0.47\mu\text{F}$  is required to prevent oscillations. Larger output capacitors will be required for applications with large transient loads to limit peak voltage transients. See the Applications Information section for more information on output capacitance and reverse output characteristics.

**NC (Pin 3/Pins 3, 5, 6, 7):** No Connect. No Connect pins may be floated, tied to IN or tied to GND.

## APPLICATIONS INFORMATION

The LT3014B is a 20mA high voltage, low dropout regulator with micropower quiescent current. The device is capable of supplying 20mA at a dropout voltage of 350mV. Operating quiescent current is only 7µA. In addition to the low quiescent current, the LT3014B incorporates several protection features which make it ideal for use in battery-powered systems. The device is protected against both reverse input and reverse output voltages. In battery backup applications where the output can be held up by a backup battery when the input is pulled to ground, the LT3014B acts like it has a diode in series with its output and prevents reverse current flow.

### Adjustable Operation

The LT3014B has an output voltage range of 1.22V to 60V. The output voltage is set by the ratio of two external resistors as shown in Figure 1. The device servos the output to maintain the voltage at the adjust pin at 1.22V referenced to ground. The current in R1 is then equal to 1.22V/R1 and the current in R2 is the current in R1 plus the ADJ pin bias current. The ADJ pin bias current, 4nA at 25°C, flows through R2 into the ADJ pin. The output voltage can be calculated using the formula in Figure 1. The value of R1 should be less than 1.62M to minimize errors in the output voltage caused by the ADJ pin bias current. The device is tested and specified with the ADJ pin tied to the OUT pin and a 5µA DC load (unless otherwise specified) for an output voltage of 1.22V. Specifications for output voltages greater than 1.22V will be proportional to the ratio of the desired output voltage to 1.22V ( $V_{OUT}/1.22V$ ). For example, load regulation for an output current change of 1mA to 20mA is -13mV typical at  $V_{OUT} = 1.22V$ . At  $V_{OUT} = 12V$ , load regulation is:

$$(12V/1.22V) \cdot (-13mV) = -128mV$$

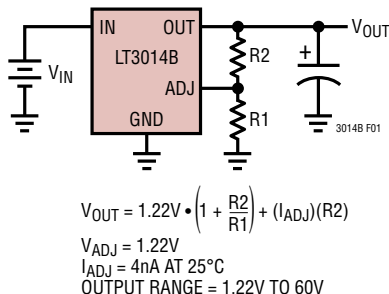

Figure 1. Adjustable Operation

### Output Capacitance and Transient Response

The LT3014B is designed to be stable with a wide range of output capacitors. The ESR of the output capacitor affects stability, most notably with small capacitors. A minimum output capacitor of 0.47µF with an ESR of 3Ω or less is recommended to prevent oscillations. The LT3014B is a micropower device and output transient response will be a function of output capacitance. Larger values of output capacitance decrease the peak deviations and provide improved transient response for larger load current changes. Bypass capacitors, used to decouple individual components powered by the LT3014B, will increase the effective output capacitor value.

Extra consideration must be given to the use of ceramic capacitors. Ceramic capacitors are manufactured with a variety of dielectrics, each with different behavior across temperature and applied voltage. The most common dielectrics used are specified with EIA temperature characteristic codes of Z5U, Y5V, X5R and X7R. The Z5U and Y5V dielectrics are good for providing high capacitances in a small package, but they tend to have strong voltage and temperature coefficients as shown in Figures 2 and 3. When used with a 5V regulator, a 16V 10µF Y5V capacitor can exhibit an effective value as low as 1µF to 2µF for the DC bias voltage applied and over the operating temperature range. The X5R and X7R dielectrics result in more stable characteristics and are more suitable for use as the output capacitor. The X7R type has better stability across temperature, while the X5R is less expensive and is avail-

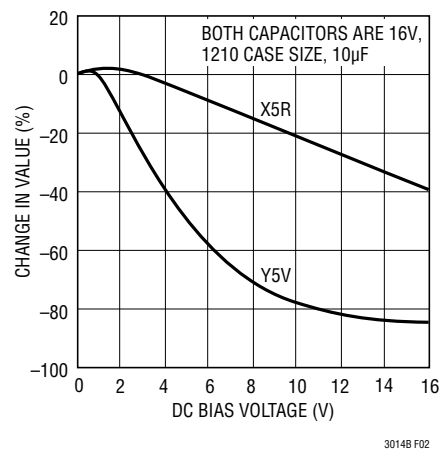
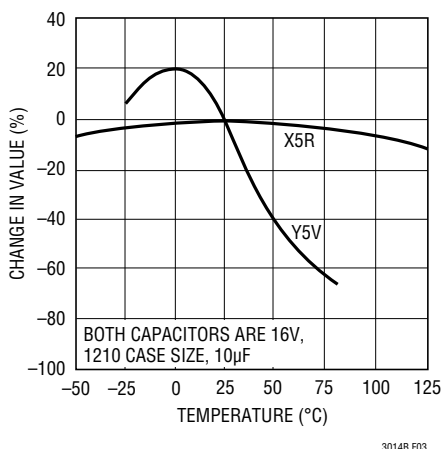

Figure 2. Ceramic Capacitor DC Bias Characteristics

## APPLICATIONS INFORMATION



**Figure 3. Ceramic Capacitor Temperature Characteristics**

able in higher values. Care still must be exercised when using X5R and X7R capacitors; the X5R and X7R codes only specify operating temperature range and maximum capacitance change over temperature. Capacitance change due to DC bias with X5R and X7R capacitors is better than Y5V and Z5U capacitors, but can still be significant enough to drop capacitor values below appropriate levels. Capacitor DC bias characteristics tend to improve as component case size increases, but expected capacitance at operating voltage should be verified.

Voltage and temperature coefficients are not the only sources of problems. Some ceramic capacitors have a piezoelectric response. A piezoelectric device generates voltage across its terminals due to mechanical stress, similar to the way a piezoelectric accelerometer or microphone works. For a ceramic capacitor the stress can be induced by vibrations in the system or thermal transients.

### Thermal Considerations

The power handling capability of the device will be limited by the maximum rated junction temperature (125°C). The power dissipated by the device will be made up of two components:

1. Output current multiplied by the input/output voltage differential:  $I_{OUT} \cdot (V_{IN} - V_{OUT})$  and,
2. GND pin current multiplied by the input voltage:  $I_{GND} \cdot V_{IN}$ .

The GND pin current can be found by examining the GND Pin Current curves in the Typical Performance Characteristics. Power dissipation will be equal to the sum of the two components listed above.

The LT3014B regulator has internal thermal limiting designed to protect the device during overload conditions. For continuous normal conditions the maximum junction temperature rating of 125°C must not be exceeded. It is important to give careful consideration to all sources of thermal resistance from junction to ambient. Additional heat sources mounted nearby must also be considered.

For surface mount devices, heat sinking is accomplished by using the heat spreading capabilities of the PC board and its copper traces. Copper board stiffeners and plated through-holes can also be used to spread the heat generated by power devices.

The following table lists thermal resistance for several different board sizes and copper areas. All measurements were taken in still air on 3/32" FR-4 board with one ounce copper.

**Table 1. SOT-23 Measured Thermal Resistance**

COPPER AREA		BOARD AREA	THERMAL RESISTANCE (JUNCTION-TO-AMBIENT)
TOPSIDE	BACKSIDE		
2500 sq mm	2500 sq mm	2500 sq mm	125°C/W
1000 sq mm	2500 sq mm	2500 sq mm	125°C/W
225 sq mm	2500 sq mm	2500 sq mm	130°C/W
100 sq mm	2500 sq mm	2500 sq mm	135°C/W
50 sq mm	2500 sq mm	2500 sq mm	150°C/W

**Table 2. DFN Measured Thermal Resistance**

COPPER AREA		BOARD AREA	THERMAL RESISTANCE (JUNCTION-TO-AMBIENT)
TOPSIDE	BACKSIDE		
2500 sq mm	2500 sq mm	2500 sq mm	40°C/W
1000 sq mm	2500 sq mm	2500 sq mm	45°C/W
225 sq mm	2500 sq mm	2500 sq mm	50°C/W
100 sq mm	2500 sq mm	2500 sq mm	62°C/W

For the DFN package, the thermal resistance junction-to-case ( $\theta_{JC}$ ), measured at the Exposed Pad on the back of the die, is 16°C/W.

## APPLICATIONS INFORMATION

Continuous operation at large input/output voltage differentials and maximum load current is not practical due to thermal limitations. Transient operation at high input/output differentials is possible. The approximate thermal time constant for a 2500sq mm 3/32" FR-4 board with maximum topside and backside area for one ounce copper is 3 seconds. This time constant will increase as more thermal mass is added (i.e. vias, larger board, and other components).

For an application with transient high power peaks, average power dissipation can be used for junction temperature calculations as long as the pulse period is significantly less than the thermal time constant of the device and board.

### Calculating Junction Temperature

Example 1: Given an output voltage of 5V, an input voltage range of 24V to 30V, an output current range of 0mA to 20mA, and a maximum ambient temperature of 50°C, what will the maximum junction temperature be?

The power dissipated by the device will be equal to:

$$I_{OUT(MAX)} \cdot (V_{IN(MAX)} - V_{OUT}) + (I_{GND} \cdot V_{IN(MAX)})$$

where:

$$I_{OUT(MAX)} = 20mA$$

$$V_{IN(MAX)} = 30V$$

$$I_{GND} \text{ at } (I_{OUT} = 20mA, V_{IN} = 30V) = 0.55mA$$

So:

$$P = 20mA \cdot (30V - 5V) + (0.55mA \cdot 30V) = 0.52W$$

The thermal resistance for the DFN package will be in the range of 40°C/W to 62°C/W depending on the copper area. So the junction temperature rise above ambient will be approximately equal to:

$$0.52W \cdot 50°C/W = 26°C$$

The maximum junction temperature will then be equal to the maximum junction temperature rise above ambient plus the maximum ambient temperature or:

$$T_{JMAX} = 50°C + 26°C = 76°C$$

Example 2: Given an output voltage of 5V, an input voltage of 48V that rises to 72V for 5ms(max) out of every 100ms, and a 5mA load that steps to 20mA for 50ms out of every 250ms, what is the junction temperature rise above ambient? Using a 500ms period (well under the time constant of the board), power dissipation is as follows:

$$P1(48V \text{ in, } 5mA \text{ load}) = 5mA \cdot (48V - 5V) + (100\mu A \cdot 48V) = 0.22W$$

$$P2(48V \text{ in, } 20mA \text{ load}) = 20mA \cdot (48V - 5V) + (0.55mA \cdot 48V) = 0.89W$$

$$P3(72V \text{ in, } 5mA \text{ load}) = 5mA \cdot (72V - 5V) + (100\mu A \cdot 72V) = 0.34W$$

$$P4(72V \text{ in, } 20mA \text{ load}) = 20mA \cdot (72V - 5V) + (0.55mA \cdot 72V) = 1.38W$$

Operation at the different power levels is as follows:

76% operation at P1, 19% for P2, 4% for P3, and 1% for P4.

$$P_{EFF} = 76\%(0.22W) + 19\%(0.89W) + 4\%(0.34W) + 1\%(1.38W) = 0.36W$$

With a thermal resistance in the range of 40°C/W to 62°C/W, this translates to a junction temperature rise above ambient of 20°C.

### Protection Features

The LT3014B incorporates several protection features which make it ideal for use in battery-powered circuits. In addition to the normal protection features associated with monolithic regulators, such as current limiting and thermal limiting, the device is protected against reverse-input voltages, and reverse voltages from output to input.

Current limit protection and thermal overload protection are intended to protect the device against current overload conditions at the output of the device. For normal operation, the junction temperature should not exceed 125°C.

The input of the device will withstand reverse voltages of 80V. Current flow into the device will be limited to less than 6mA (typically less than 100μA) and no negative

## APPLICATIONS INFORMATION

voltage will appear at the output. The device will protect both itself and the load. This provides protection against batteries which can be plugged in backward.

The ADJ pin can be pulled above or below ground by as much as 7V without damaging the device. If the input is left open circuit or grounded, the ADJ pin will act like an open circuit when pulled below ground, and like a large resistor (typically 100k) in series with a diode when pulled above ground. If the input is powered by a voltage source, pulling the ADJ pin below the reference voltage will cause the device to current limit. This will cause the output to go to an unregulated high voltage. Pulling the ADJ pin above the reference voltage will turn off all output current.

In situations where the ADJ pin is connected to a resistor divider that would pull the ADJ pin above its 7V clamp voltage if the output is pulled high, the ADJ pin input current must be limited to less than 5mA. For example, a resistor divider is used to provide a regulated 1.5V output from the 1.22V reference when the output is forced to 60V. The top resistor of the resistor divider must be chosen to limit the current into the ADJ pin to less than 5mA when the ADJ pin is at 7V. The 53V difference between the OUT and ADJ pins divided by the 5mA maximum current into the ADJ pin yields a minimum top resistor value of 10.6k.

In circuits where a backup battery is required, several different input/output conditions can occur. The output voltage may be held up while the input is either pulled

to ground, pulled to some intermediate voltage, or is left open circuit. Current flow back into the output will follow the curve shown in Figure 4. The rise in reverse output current above 7V occurs from the breakdown of the 7V clamp on the ADJ pin. With a resistor divider on the regulator output, this current will be reduced depending on the size of the resistor divider.

When the IN pin of the LT3014B is forced below the OUT pin or the OUT pin is pulled above the IN pin, input current will typically drop to less than 2μA. This can happen if the input of the LT3014B is connected to a discharged (low voltage) battery and the output is held up by either a backup battery or a second regulator circuit.

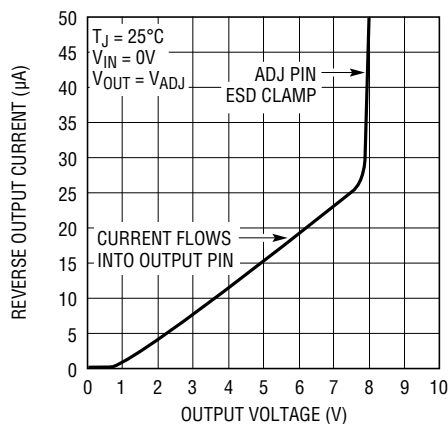
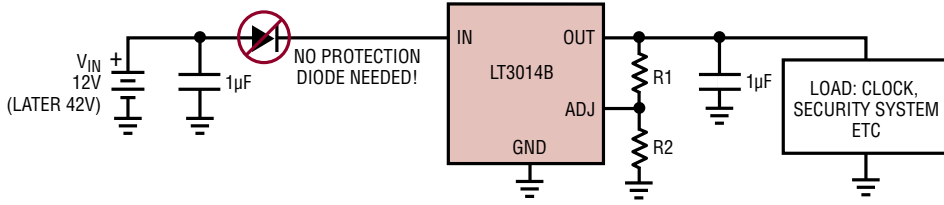

Figure 4. Reverse Output Current

## TYPICAL APPLICATIONS

### LT3014B Automotive Application



### LT3014B Telecom Application

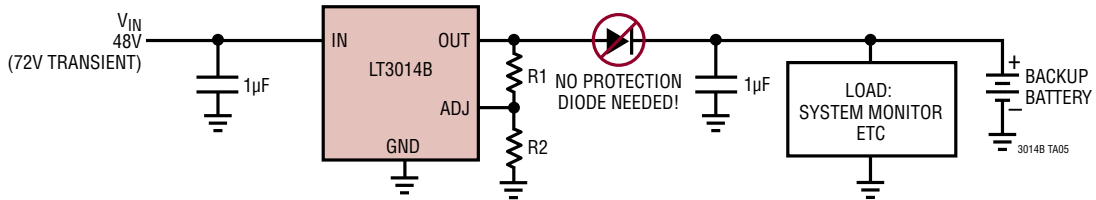

# PACKAGE DESCRIPTION

Please refer to <http://www.linear.com/designtools/packaging/> for the most recent package drawings.

## S5 Package 5-Lead Plastic TSOT-23 (Reference LTC DWG # 05-08-1635)

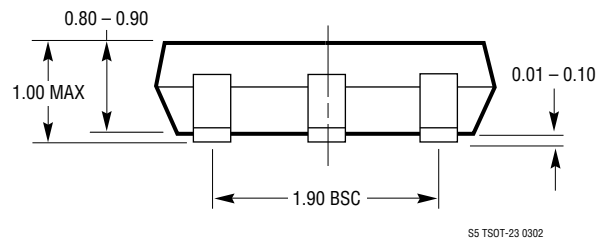
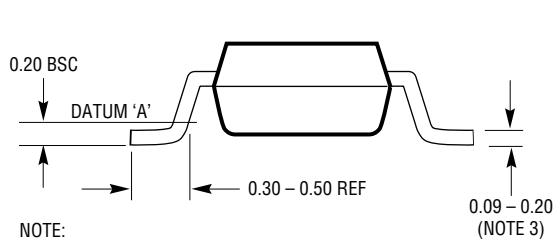
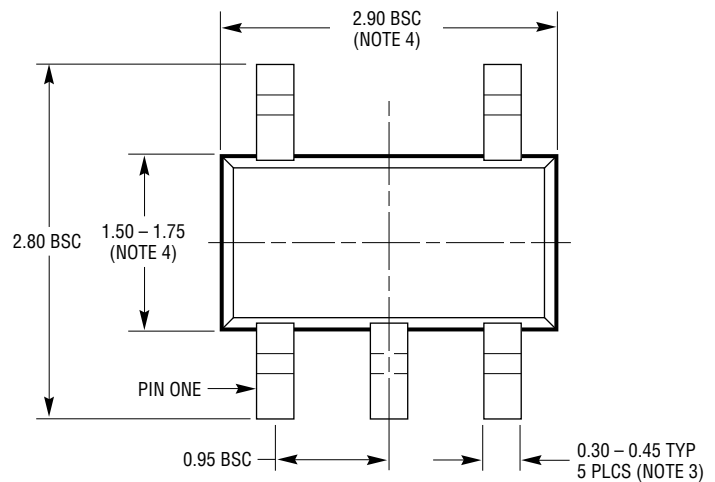
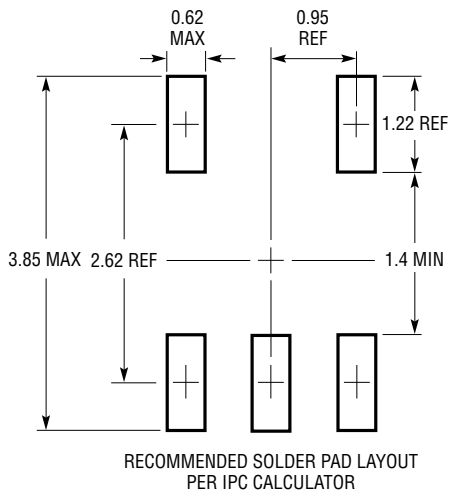

- NOTE:
1. DIMENSIONS ARE IN MILLIMETERS
  2. DRAWING NOT TO SCALE
  3. DIMENSIONS ARE INCLUSIVE OF PLATING
  4. DIMENSIONS ARE EXCLUSIVE OF MOLD FLASH AND METAL BURR
  5. MOLD FLASH SHALL NOT EXCEED 0.254mm
  6. JEDEC PACKAGE REFERENCE IS MO-193

S5 TSOT-23 0302

## PACKAGE DESCRIPTION

Please refer to <http://www.linear.com/designtools/packaging/> for the most recent package drawings.

### DD Package 8-Lead Plastic DFN (3mm × 3mm) (Reference LTC DWG # 05-08-1698 Rev C)

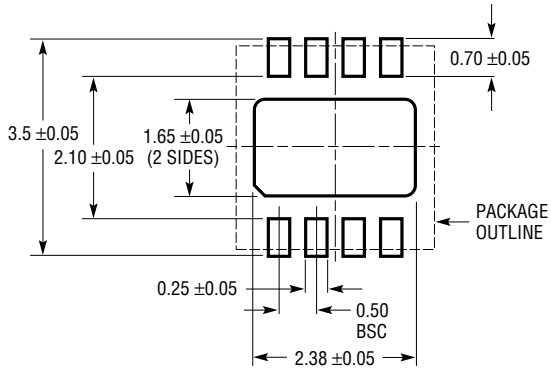

RECOMMENDED SOLDER PAD PITCH AND DIMENSIONS  
APPLY SOLDER MASK TO AREAS THAT ARE NOT SOLDERED

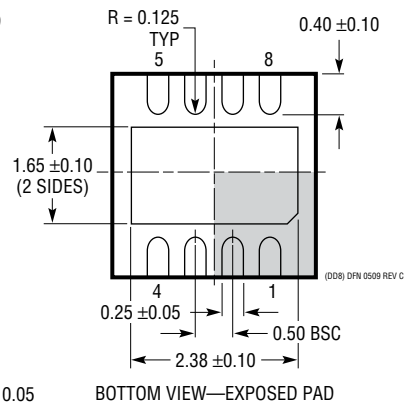
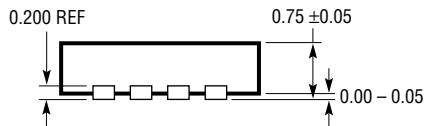
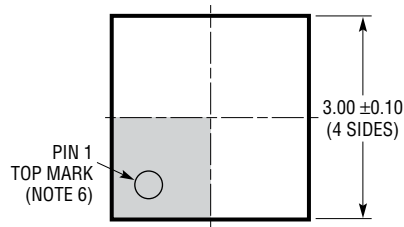

**NOTE:**

1. DRAWING TO BE MADE A JEDEC PACKAGE OUTLINE M0-229 VARIATION OF (WEED-1)
2. DRAWING NOT TO SCALE
3. ALL DIMENSIONS ARE IN MILLIMETERS
4. DIMENSIONS OF EXPOSED PAD ON BOTTOM OF PACKAGE DO NOT INCLUDE MOLD FLASH. MOLD FLASH, IF PRESENT, SHALL NOT EXCEED 0.15mm ON ANY SIDE
5. EXPOSED PAD SHALL BE SOLDER PLATED
6. SHADED AREA IS ONLY A REFERENCE FOR PIN 1 LOCATION ON TOP AND BOTTOM OF PACKAGE

**REVISION HISTORY** (Revision history begins at Rev B)

REV	DATE	DESCRIPTION	PAGE NUMBER
B	11/14	Add MP-Grade Modified Related Parts	2, 3, 4 16

## TYPICAL APPLICATIONS

### Constant Brightness for Indicator LED over Wide Input Voltage Range

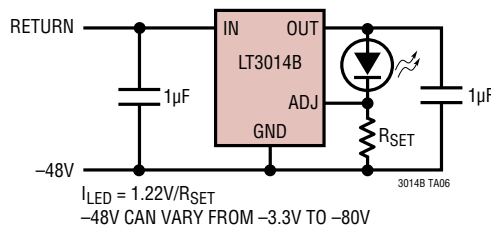

## RELATED PARTS

PART NUMBER	DESCRIPTION	COMMENTS
<a href="#">LT1129</a>	700mA, Micropower, LDO	$V_{IN}$ : 4.2V to 30V, $V_{OUT(MIN)}$ = 3.75V, $V_{DO}$ = 0.4V, $I_Q$ = 50µA, $I_{SD}$ = 16µA, DD, SOT-223, S8, TO220, TSSOP-20 Packages
<a href="#">LT1175</a>	500mA, Micropower Negative LDO	$V_{IN}$ : -20V to -4.3V, $V_{OUT(MIN)}$ = -3.8V, $V_{DO}$ = 0.50V, $I_Q$ = 45µA, $I_{SD}$ = 10µA, DD, SOT-223, S8 Packages
<a href="#">LT1185</a>	3A, Negative LDO	$V_{IN}$ : -35V to -4.2V, $V_{OUT(MIN)}$ = -2.40V, $V_{DO}$ = 0.80V, $I_Q$ = 2.5mA, $I_{SD}$ < 1µA, TO220-5 Package
<a href="#">LT1761</a>	100mA, Low Noise Micropower, LDO	$V_{IN}$ : 1.8V to 20V, $V_{OUT(MIN)}$ = 1.22V, $V_{DO}$ = 0.30V, $I_Q$ = 20µA, $I_{SD}$ < 1µA, ThinSOT Package
<a href="#">LT1762</a>	150mA, Low Noise Micropower, LDO	$V_{IN}$ : 1.8V to 20V, $V_{OUT(MIN)}$ = 1.22V, $V_{DO}$ = 0.30V, $I_Q$ = 25µA, $I_{SD}$ < 1µA, MS8 Package
<a href="#">LT1763</a>	500mA, Low Noise Micropower, LDO	$V_{IN}$ : 1.8V to 20V, $V_{OUT(MIN)}$ = 1.22V, $V_{DO}$ = 0.30V, $I_Q$ = 30µA, $I_{SD}$ < 1µA, S8 and DFN Packages
<a href="#">LT1764/LT1764A</a>	3A, Low Noise, Fast Transient Response, LDO	$V_{IN}$ : 2.7V to 20V, $V_{OUT(MIN)}$ = 1.21V, $V_{DO}$ = 0.34V, $I_Q$ = 1mA, $I_{SD}$ < 1µA, DD, TO220 Packages
<a href="#">LTC1844</a>	150mA, Very Low Dropout LDO	$V_{IN}$ : 1.6V to 6.5V, $V_{OUT(MIN)}$ = 1.25V, $V_{DO}$ = 0.08V, $I_Q$ = 40µA, $I_{SD}$ < 1µA, ThinSOT Package
<a href="#">LT1962</a>	300mA, Low Noise Micropower, LDO	$V_{IN}$ : 1.8V to 20V, $V_{OUT(MIN)}$ = 1.22V, $V_{DO}$ = 0.27V, $I_Q$ = 30µA, $I_{SD}$ < 1µA, MS8 Package
<a href="#">LT1963/LT1963A</a>	1.5A, Low Noise, Fast Transient Response, LDO	$V_{IN}$ : 2.1V to 20V, $V_{OUT(MIN)}$ = 1.21V, $V_{DO}$ = 0.34V, $I_Q$ = 1mA, $I_{SD}$ < 1µA, DD, TO220, SOT-223 and S8 Packages
<a href="#">LT1964</a>	200mA, Low Noise Micropower, Negative LDO	$V_{IN}$ : -1.9V to -20V, $V_{OUT(MIN)}$ = -1.21V, $V_{DO}$ = 0.34V, $I_Q$ = 30µA, $I_{SD}$ = 3µA, ThinSOT and DFN Packages
<a href="#">LT3010</a>	50mA, 80V, Low Noise Micropower, LDO	$V_{IN}$ : 3V to 80V, $V_{OUT(MIN)}$ = 1.28V, $V_{DO}$ = 0.3V, $I_Q$ = 30µA, $I_{SD}$ < 1µA, MS8E Package
<a href="#">LT3020</a>	100mA, Low $V_{IN}$ , Low $V_{OUT}$ Micropower, VLDO	$V_{IN}$ : 0.9V to 10V, $V_{OUT(MIN)}$ = 0.20V, $V_{DO}$ = 0.15V, $I_Q$ = 120µA, $I_{SD}$ < 1µA, DFN, MS8 Packages
<a href="#">LT3023</a>	Dual 100mA, Low Noise Micropower, LDO	$V_{IN}$ : 1.8V to 20V, $V_{OUT(MIN)}$ = 1.22V, $V_{DO}$ = 0.30V, $I_Q$ = 40µA, $I_{SD}$ < 1µA, DFN, MS10 Packages
<a href="#">LT3024</a>	Dual 100mA/500mA, Low Noise Micropower, LDO	$V_{IN}$ : 1.8V to 20V, $V_{OUT(MIN)}$ = 1.22V, $V_{DO}$ = 0.30V, $I_Q$ = 60µA, $I_{SD}$ < 1µA, DFN, TSSOP-16E Packages
<a href="#">LT3027</a>	Dual 100mA, Low Noise LDO with Independent Inputs	$V_{IN}$ : 1.8V to 20V, $V_{OUT(MIN)}$ = 1.22V, $V_{DO}$ = 0.30V, $I_Q$ = 40µA, $I_{SD}$ < 1µA, DFN, MS10E Packages
<a href="#">LT3028</a>	Dual 100mA/500mA, Low Noise LDO with Independent Inputs	$V_{IN}$ : 1.8V to 20V, $V_{OUT(MIN)}$ = 1.22V, $V_{DO}$ = 0.30V, $I_Q$ = 60µA, $I_{SD}$ < 1µA, DFN, TSSOP-16E Packages

## Looking for pricing, stock, or lifecycle information?

Click below to explore more details on WIN SOURCE:

- ⊖ [View LT3014BIDD#TRPBF on WIN SOURCE](#)
- ⊖ [Analog Devices Inc. Information](#)

## Optimize Your Supply Chain with WIN SOURCE Solutions

- ✓ Global Sourcing Solution
- ✓ Obsolete Management
- ✓ Cost Control Management
- ✓ Shortage Management
- ✓ Alternative Solution
- ✓ Excess Inventory Management