



**THE DATASHEET OF  
LTC1502CMS8-3.3#TRPBF**



# Single Cell to 3.3V Regulated Charge Pump DC/DC Converter

## FEATURES

- **Input Voltage Range: 0.9V to 1.8V**
- **0.9V Guaranteed Start-Up Voltage**
- Regulated Output Voltage:  $3.3V \pm 4\%$
- Output Current: 10mA ( $V_{IN} \geq 1V$ )
- **No Inductors**
- **Shutdown Disconnects Load from  $V_{IN}$**
- Low Operating Current: 40 $\mu$ A
- Low Shutdown Current: 5 $\mu$ A
- Short-Circuit and Overtemperature Protected
- **Application Circuit Fits in  $<0.125in^2$  PCB Area**
- Available in 8-Pin MSOP and SO Packages

## APPLICATIONS

- Pagers
- Battery Backup Supplies
- Portable Electronic Equipment
- Handheld Medical Instruments
- Glucose Meters

## DESCRIPTION

The LTC<sup>®</sup>1502-3.3 is a quadrupler charge pump DC/DC converter that produces a regulated 3.3V output from a single alkaline cell input. It requires only five small external capacitors—no inductors are required. Low supply current (40 $\mu$ A typical, 5 $\mu$ A in shutdown) and minimal external components make the LTC1502-3.3 ideal for space and power conscious single-cell applications. The total printed circuit board area of the circuit shown below is less than 0.125in<sup>2</sup>.

Forcing the C1<sup>-</sup>/SHDN pin low through an external resistive pull-down puts the part into shutdown mode. During shutdown, the internal oscillator is stopped and the load is disconnected from  $V_{IN}$ . An internal pull-up current on the C1<sup>-</sup>/SHDN pin forces the part back into normal operation once the pull-down resistance is removed.

The LTC1502-3.3 is short-circuit protected and survives an indefinite  $V_{OUT}$  short to ground. The LTC1502-3.3 is available in 8-pin MSOP and SO packages.

 LTC and LT are registered trademarks of Linear Technology Corporation.

## TYPICAL APPLICATION

Single Cell to 3.3V DC/DC Converter

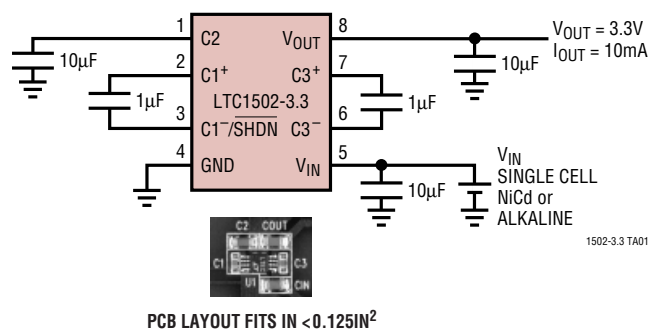

Output Voltage vs Input Voltage

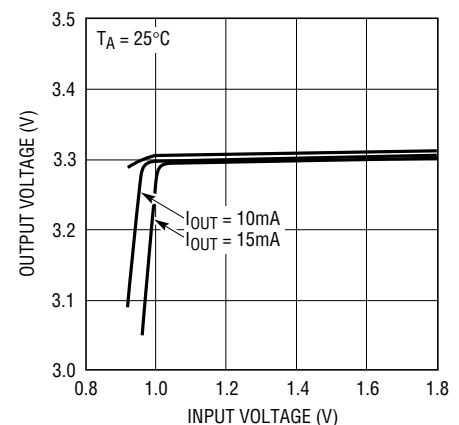

1502-3.3 TA02

# LTC1502-3.3

## ABSOLUTE MAXIMUM RATINGS (Note 1)

$V_{IN}$ to GND .....	-0.3V to 2V	Operating Temperature Range	
$V_{OUT}$ to GND .....	-0.3V to 5V	Commercial .....	0°C to 70°C
All Other Pins to GND .....	-0.3V to 5V	Extended Commercial (Note 4) .....	-40°C to 85°C
$V_{OUT}$ Short-Circuit Duration .....	Indefinite	Industrial .....	-40°C to 85°C
Storage Temperature Range .....	-65°C to 150°C	Lead Temperature (Soldering, 10 sec) .....	300°C

## PACKAGE/ORDER INFORMATION

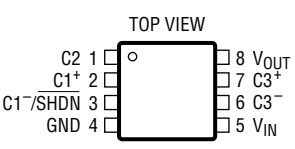
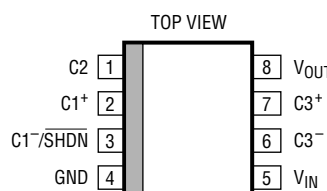
 <p>MS8 PACKAGE 8-LEAD PLASTIC MSOP <math>T_{JMAX} = 125^{\circ}\text{C}</math>, <math>\theta_{JA} = 250^{\circ}\text{C/W}</math></p>	ORDER PART NUMBER	 <p>S8 PACKAGE 8-LEAD PLASTIC SO <math>T_{JMAX} = 125^{\circ}\text{C}</math>, <math>\theta_{JA} = 150^{\circ}\text{C/W}</math></p>	ORDER PART NUMBER
	LTC1502CMS8-3.3		LTC1502CS8-3.3 LTC1502IS8-3.3
	MS8 PART MARKING		S8 PART MARKING
	LTEC		150233 502133

Consult factory for Military grade parts.

## ELECTRICAL CHARACTERISTICS

The ● denotes the specifications which apply over the full operating temperature range, otherwise specifications are at  $T_A = 25^{\circ}\text{C}$ .  
 $V_{IN} = 0.9\text{V}$  to  $1.8\text{V}$ ,  $C1 = C3 = 1\mu\text{F}$ ,  $C_{IN} = C2 = C_{OUT} = 10\mu\text{F}$  unless otherwise specified.

PARAMETER	CONDITIONS	MIN	TYP	MAX	UNITS
$V_{IN}$ Operating Voltage		● 0.9		1.8	V
Minimum $V_{IN}$ Start-Up Voltage	$T_A = 0^{\circ}\text{C}$ to $70^{\circ}\text{C}$ (Note 2)	●	0.75	0.9	V
	$T_A = -40^{\circ}\text{C}$ to $85^{\circ}\text{C}$ (Note 2)	●		1.1	V
$V_{OUT}$ Voltage	$I_{OUT} \leq 3.5\text{mA}$ , $0.9\text{V} \leq V_{IN} \leq 1.8\text{V}$	● 3.17	3.3	3.43	V
	$I_{OUT} \leq 10\text{mA}$ , $1\text{V} \leq V_{IN} \leq 1.8\text{V}$	● 3.17	3.3	3.43	V
$V_{IN}$ Operating Current	$I_{OUT} = 0\text{mA}$	●	40	90	$\mu\text{A}$
$V_{IN}$ Shutdown Current	$C1/\overline{\text{SHDN}} = 0\text{V}$	●	5	15	$\mu\text{A}$
Output Ripple	$I_{OUT} = 10\text{mA}$ , $V_{IN} = 1.25\text{V}$		50		mV <sub>p-p</sub>
Efficiency	$V_{IN} = 1\text{V}$ , $I_{OUT} = 10\text{mA}$		77		%
Switching Frequency	Oscillator Free-Running		500		kHz
$C1/\overline{\text{SHDN}}$ Shutdown Input Threshold	$C1/\overline{\text{SHDN}}$ in Hi-Z Sampling State	● 0.20	0.55	0.85	V
$C1/\overline{\text{SHDN}}$ Shutdown Input Current	$C1/\overline{\text{SHDN}} = 0\text{V}$ (Note 3)	● -0.5	-2.5	-8	$\mu\text{A}$
$V_{OUT}$ Turn-On Time	$V_{IN} = 1\text{V}$ , $I_{OUT} = 0\text{mA}$		5		ms
$V_{OUT}$ Short-Circuit Current	$V_{IN} = 1.5\text{V}$ , $V_{OUT}$ Forced to 0V		20		mA

**Note 1:** Absolute Maximum Ratings are those values beyond which the life of the device may be impaired.

**Note 2:** Start-up testing is done with a 100k $\Omega$  equivalent load on  $V_{OUT}$ .

**Note 3:** Currents flowing into the device are positive polarity. Currents flowing out of the device are negative polarity.

**Note 4:** Commercial grade specifications are guaranteed over the 0°C to 70°C operating temperature range. In addition, commercial grade specifications are assured over the -40°C to 85°C operating temperature range by design, characterization and correlation with statistical process controls. Industrial grade specifications are guaranteed and tested over the -40°C to 85°C operating temperature range.

# TYPICAL PERFORMANCE CHARACTERISTICS

**No Load Input Current vs Input Voltage**

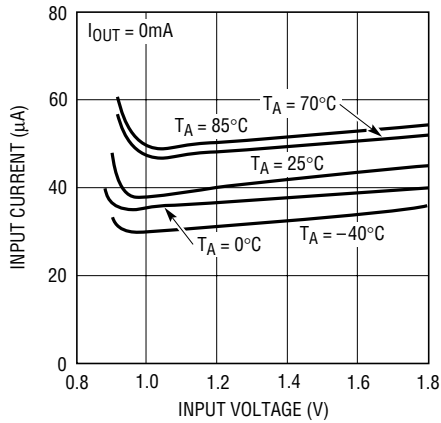

**Shutdown Input Current vs Input Voltage**

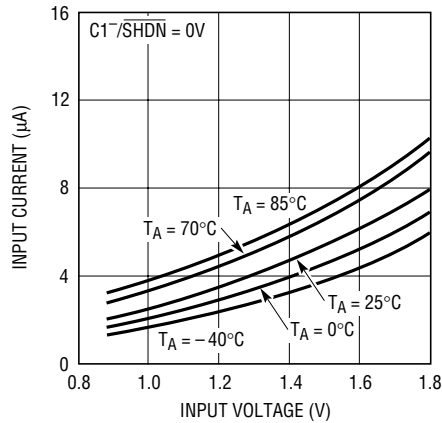

**Output Voltage vs Output Current**

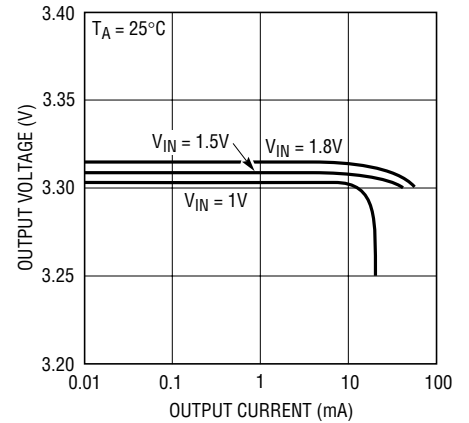

**Maximum Start-Up Load Current vs Input Voltage**

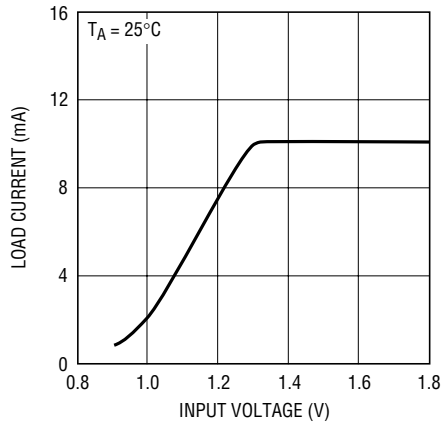

**Efficiency vs Output Current**

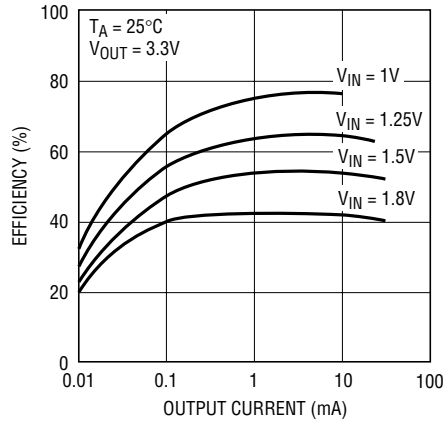

**Load Transient Response**

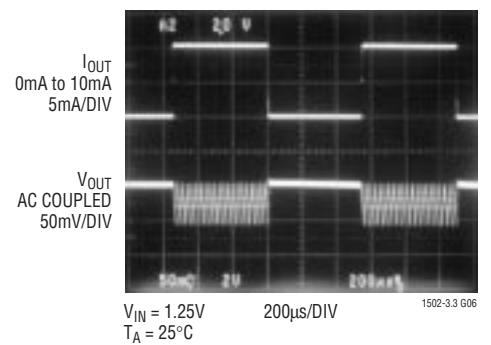

**Oscillator Frequency vs Input Voltage**

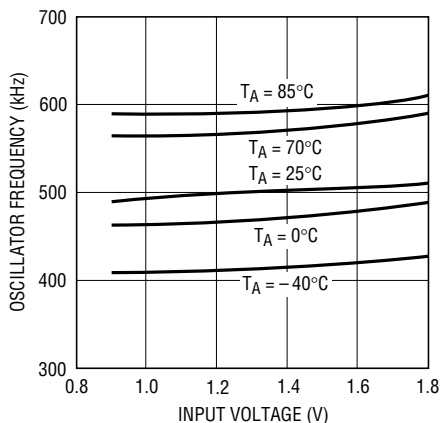

**Calculated Battery Life, Battery = 2400mA • Hr AA Cell**

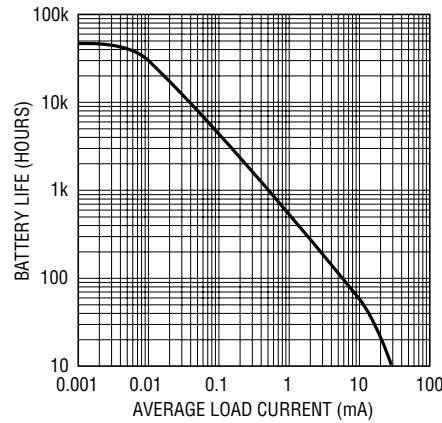

**Shutdown Waveforms (See Figure 1)**

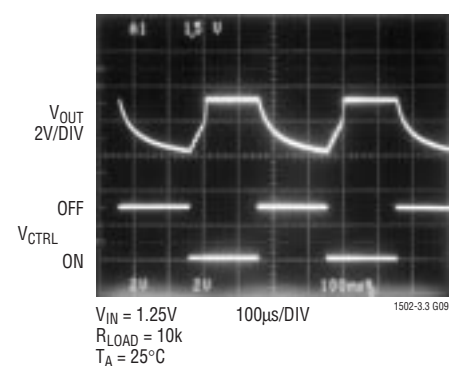



## TEST CIRCUIT

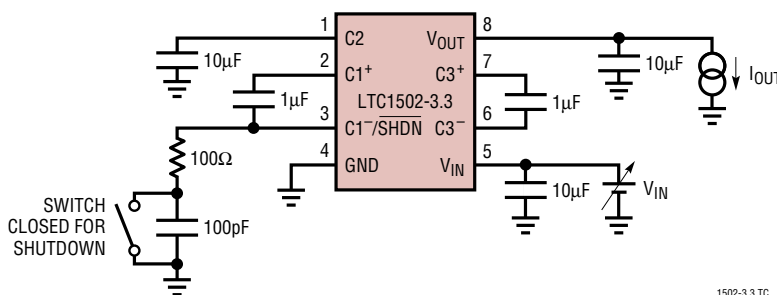

1502-3.3 TC

## APPLICATIONS INFORMATION

### Regulator Operation

The LTC1502-3.3 uses a quadrupler charge pump DC/DC converter to produce a boosted output voltage. The quadrupler charge pump consists of two voltage doubler charge pumps (CP1 and CP2 on the Block Diagram) cascaded in series. CP1 doubles the input voltage  $V_{IN}$  and the CP1 output voltage is stored on external capacitor C2. The C2 pin also serves as the input for doubler CP2 whose output is stored on the output capacitor  $C_{OUT}$ . Each doubler is controlled by a two-phase clock which is generated in the Timing Control circuit. On phase one of the clock, the flying capacitors C1 and C3 are charged to their respective input voltages. On phase two each charged flying capacitor is stacked on top of the input voltage and discharged through an internal switch onto its respective output. This sequence of charging and discharging the CP1 and CP2 flying capacitors continues at the free running oscillator frequency (500kHz typ) until the output is in regulation.

Regulation is achieved by comparing the divided down output voltage to a fixed voltage reference. The charge pump clocks are disabled when the output voltage is above the desired regulation point set by COMP1. When the output has dropped below the lower trip point of COMP1, the charge pump clocks are turned back on until  $V_{OUT}$  is boosted back into regulation.

### Enhanced Start-Up

Enhanced start-up capability is provided by the COMP2 circuitry. COMP2 compares the divided down C2 voltage to the input voltage  $V_{IN}$ . The COMP2 output disables the output charge pump CP2 whenever the divided C2 voltage

is lower than  $V_{IN}$ . The CP2 output is thereby forced into a high impedance state until the voltage on C2 has been raised above  $V_{IN}$  (the C2 pin should not be loaded for proper start-up). This allows a higher internal gate drive voltage to be generated (from the C2 pin) before the output ( $V_{OUT}$ ) is connected to a load. Hysteresis in COMP2 forces CP2 to be turned ON and OFF while  $C_{OUT}$  is charging up to prevent a lockup condition if C2 droops too low during start-up. By the time the output nears the regulation point, the C2 voltage is well above the lower trip point of COMP2 and CP2 will remain enabled. This method of disabling the output charge pump while an internal boosted gate drive supply is developed allows the part to start up at low voltages with a larger output current load than would otherwise be possible.

### Shutdown

Shutdown is implemented using an external pull-down device on the C1-/SHDN pin. The recommended external pull-down device is an open-drain FET with resistive current limiting (see Figure 1). The pull-down device must sink up to 300µA and pull down below 0.2V to ensure proper shutdown operation, however, the actual series resistance is not critical. The pull-down device must also go into a Hi-Z state for the LTC1502-3.3 to become active.

The timing control circuitry forces the CP1 switches into a high impedance state every 16 clock cycles. The Hi-Z duration is equal to one clock cycle. At the end of the Hi-Z time interval, the voltage on the C1-/SHDN pin is sampled. If the C1-/SHDN pin has been pulled to a logic low state, the part will go into shutdown mode. When the pull-down device is disabled, an internal pull-up current

## APPLICATIONS INFORMATION

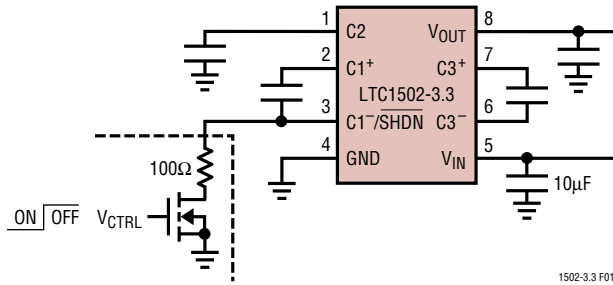

Figure 1. Pull-Down Circuitry for Shutdown

will force a logic high on the C1<sup>-</sup>/SHDN pin and put the part back into active mode. If no external pull-down is present during the Hi-Z interval, the internal pull-up current will maintain a logic high on the C1<sup>-</sup>/SHDN pin thereby keeping the part in active mode.

The shutdown feature can be used to prevent charge pump switching during noise sensitive intervals. Since the charge pump oscillator is disabled during shutdown, output switching noise can be eliminated while the external pull-down is active. The LTC1502-3.3 takes between 20μs and 50μs to switch from shutdown to active mode once the pull-down device has been turned off (assuming a 100pF external capacitance to GND on the C1<sup>-</sup>/SHDN pin). A 100k pull-up resistor from V<sub>IN</sub> to C1<sup>-</sup>/SHDN will speed up this transition by a factor of five at the expense of 10μA or so of additional shutdown current. To maintain regulation, a sufficiently large output capacitor must be used to prevent excessive V<sub>OUT</sub> droop while the charge pump is in shutdown. Also, there must be adequate time for the charge pump to recharge the output capacitor while the part is active. In other words, the average load current must be low enough for the LTC1502-3.3 to maintain a 3.3V output while the part is active.

### Capacitor Selection

For best performance, it is recommended that low ESR capacitors be used for C<sub>IN</sub>, C<sub>2</sub> and C<sub>OUT</sub> to reduce noise and ripple. The C<sub>IN</sub>, C<sub>2</sub> and C<sub>OUT</sub> capacitors should be either ceramic or tantalum and should be 10μF or greater. If the input source impedance is very low (<0.5Ω), C<sub>IN</sub> may not be needed. Ceramic capacitors are recommended for the flying capacitors C1 and C3 with values of 0.47μF to 2.2μF. Smaller values may be used in low output current applications (e.g., I<sub>OUT</sub> < 1mA).

### Output Ripple

Normal LTC1502-3.3 operation produces voltage ripple on the V<sub>OUT</sub> pin. Output voltage ripple is required for regulation. Low frequency ripple exists due to the hysteresis in the sense comparator and propagation delays in the charge pump enable/disable circuits. High frequency ripple is also present mainly from the ESR (equivalent series resistance) in the output capacitor. Typical output ripple (V<sub>IN</sub> = 1.25V) under maximum load is 50mV peak-to-peak with a low ESR 10μF output capacitor.

The magnitude of the ripple voltage depends on several factors. High input voltages increase the output ripple since more charge is delivered to C<sub>OUT</sub> per charging cycle. Large output current load and/or a small output capacitor (<10μF) results in higher ripple due to higher output voltage dV/dt. High ESR capacitors (ESR > 0.5Ω) on the output pin cause high frequency voltage spikes on V<sub>OUT</sub> with every clock cycle.

There are several ways to reduce the output voltage ripple. A larger C<sub>OUT</sub> capacitor (22μF or greater) will reduce both the low and high frequency ripple due to the lower C<sub>OUT</sub> charging and discharging dV/dt and the lower ESR typically found with higher value (larger case size) capacitors. A low ESR ceramic output capacitor will minimize the high frequency ripple, but will not reduce the low frequency ripple unless a high capacitance value is chosen. A reasonable compromise is to use a 10μF to 22μF tantalum capacitor in parallel with a 1μF to 3.3μF ceramic capacitor on V<sub>OUT</sub> to reduce both the low and high frequency ripple. An RC filter may also be used to reduce high frequency voltage spikes (see Figure 2).

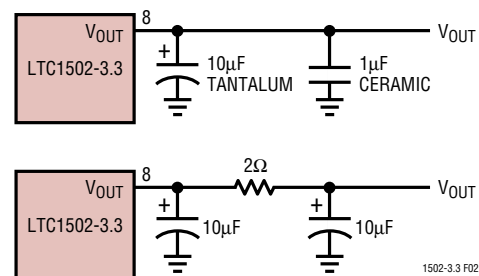

Figure 2. Output Ripple Reduction Techniques

## APPLICATIONS INFORMATION

### Short-Circuit Protection

When the output is shorted to ground, the LTC1502-3.3 will continuously charge the C2 capacitor up to approximately 1.4 times  $V_{IN}$ , and then discharge C2 into the shorted output. Since the discharging of C2 into  $V_{OUT}$  will bring the C2 voltage below the COMP2 start-up comparator trip voltage, the output charge pump will be forced Hi-Z while C2 charges up again. Hence, the internal charge

pump gate drive voltage is limited to  $(1.4)(V_{IN(MAX)})$  on the C2 pin, and no continuous current is supplied to  $V_{OUT}$ . The resulting output short-circuit current is limited to under 20mA (typ) thereby allowing the LTC1502-3.3 to endure an indefinite output short circuit without damage. When the short is removed, the part will start up, and operate normally.

## PACKAGE DESCRIPTION

Dimensions in inches (millimeters) unless otherwise noted.

**MS8 Package**  
**8-Lead Plastic MSOP**  
 (LTC DWG # 05-08-1660)

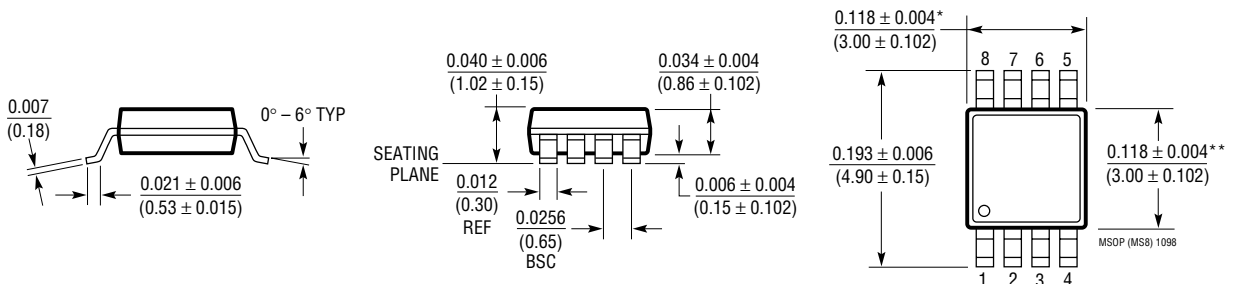

\* DIMENSION DOES NOT INCLUDE MOLD FLASH, PROTRUSIONS OR GATE BURRS. MOLD FLASH, PROTRUSIONS OR GATE BURRS SHALL NOT EXCEED  $0.006^*$  (0.152mm) PER SIDE  
 \*\* DIMENSION DOES NOT INCLUDE INTERLEAD FLASH OR PROTRUSIONS. INTERLEAD FLASH OR PROTRUSIONS SHALL NOT EXCEED  $0.006^*$  (0.152mm) PER SIDE

**S8 Package**  
**8-Lead Plastic Small Outline (Narrow 0.150)**  
 (LTC DWG # 05-08-1610)

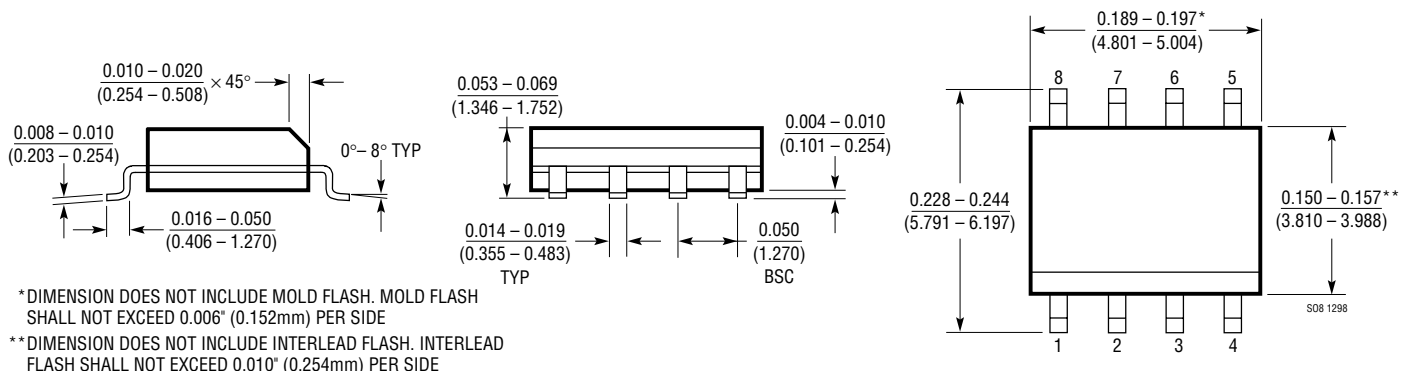

\* DIMENSION DOES NOT INCLUDE MOLD FLASH. MOLD FLASH SHALL NOT EXCEED  $0.006^*$  (0.152mm) PER SIDE  
 \*\* DIMENSION DOES NOT INCLUDE INTERLEAD FLASH. INTERLEAD FLASH SHALL NOT EXCEED  $0.010^*$  (0.254mm) PER SIDE

## TYPICAL APPLICATIONS

Single Cell to 3.3V DC/DC Converter with Shutdown

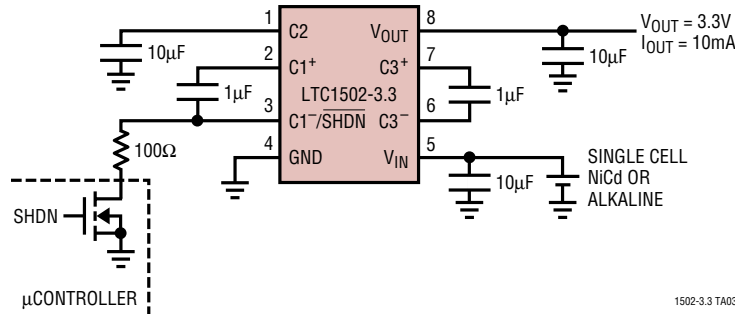

Single Cell Battery Backup Supply with Autoswitchover and No Reverse Current

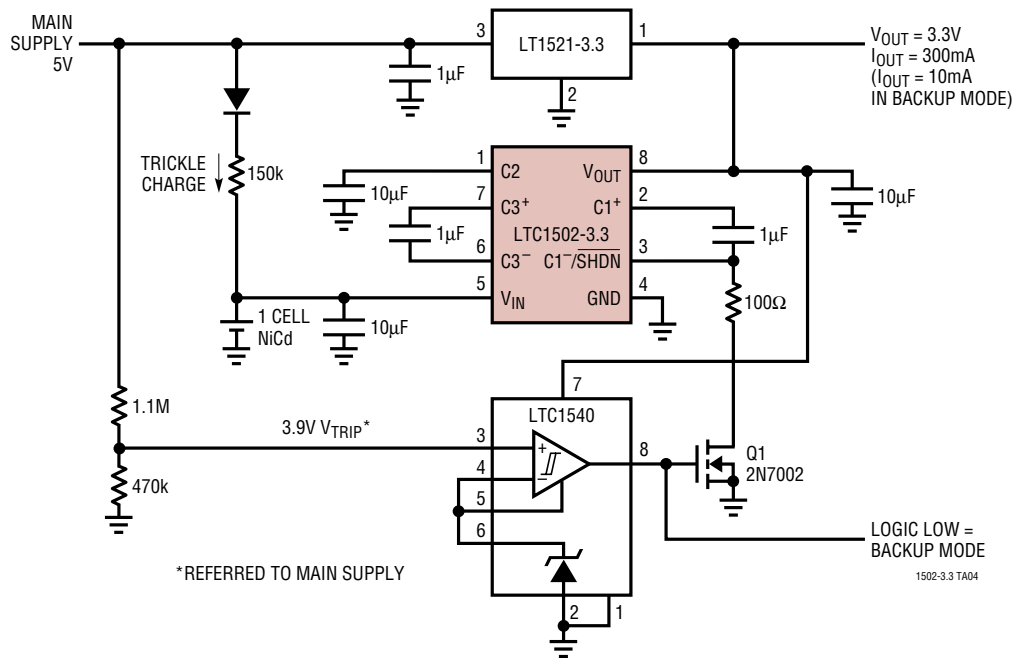

## RELATED PARTS

PART NUMBER	DESCRIPTION	COMMENTS
LT1307/LT1307B	750mA Single Cell Micropower 600kHz PWM DC/DC Converter	3.3V at 75mA from 1 Cell, MSOP Package
LT1308A/LT1308B	2A Single Cell Micropower 600kHz PWM DC/DC Converter	3.3V at 300mA from 1 Cell, SO-8 Package
LTC1517-3.3	Micropower Regulated 3.3V Charge Pump DC/DC Converter	I <sub>OUT</sub> = 15mA (V <sub>IN</sub> ≥ 2.5V)
LTC1558/LTC1559	Backup Battery Controller with Programmable Output	Uses Single NiCd Cell, 100mW Output (Min)
LT1610	Single Cell Micropower 1.7MHz PWM DC/DC Converter	30μA I <sub>Q</sub> , MSOP Package
LT1611	1.4MHz Inverting Switching Regulator	5V to -5V at 150mA, Low Output Noise, SOT-23 package
LT1613	1.4MHz Boost Switching Regulator	5V at 200mA from 3.3V Input, SOT-23 Package
LT1615	Micropower Boost Switching Regulator	30μA I <sub>Q</sub> , V <sub>OUT</sub> Up to 34V, SOT-23 Package
LTC1682	Low Noise Doubler Charge Pump	60μV <sub>RMS</sub> Noise, I <sub>OUT</sub> Up to 50mA, MSOP

## Looking for pricing, stock, or lifecycle information?

Click below to explore more details on WIN SOURCE:

- ⊖ [View LTC1502CMS8-3.3#TRPBF on WIN SOURCE](#)
- ⊖ [Analog Devices Inc. Information](#)

## Optimize Your Supply Chain with WIN SOURCE Solutions

- ✓ Global Sourcing Solution
- ✓ Obsolete Management
- ✓ Cost Control Management
- ✓ Shortage Management
- ✓ Alternative Solution
- ✓ Excess Inventory Management