



**THE DATASHEET OF
LTC3786IMSE#TRPBF**



LTpowerPlanner III System-Level Design Tool Quick Start Guide

Ver. 3.0.0
January 2016

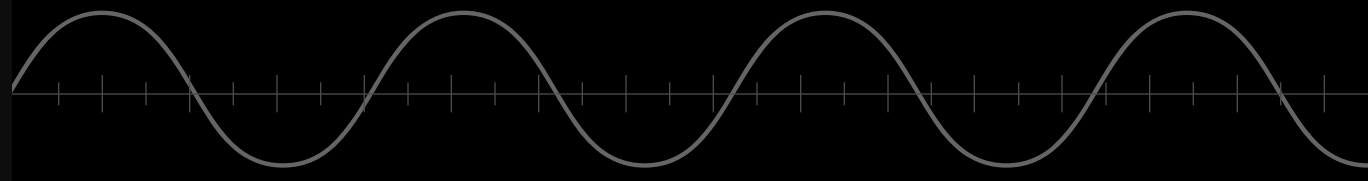

Design Tool Development Team
Applications Engineering
Power Products, Linear Technology Corp.

LTpowerCAD@linear.com

Linear Technology Corporation Copyright.

Last Update: 1/2016



LTpowerPlanner™

A System-Level Power Architecture Planning Tool:

- ✓ Create a **“Power Tree”** diagram of your Power Management System
- ✓ Estimate **Total System Power, Efficiency and Solution Size**
- ✓ **Compare** different system architectures for optimum solution
- ✓ Display and Copy Block Diagram for **System Presentation**
- ✓ Save and Load System Design Files for **Project Organization**
- ✓ Interface with LTspice™ Simulation file
- ✓ Interface with LTpowerCAD™ Design Tool file
- ✓ Available in LTpowerCAD Toolbox, **free download** at www.linear.com/ltpowercad
- ✓ Offline program on PC with Windows 7, 8 or 10.

LTpowerPlanner™

Located inside the LTpowerCAD “LTC Toolbox”:

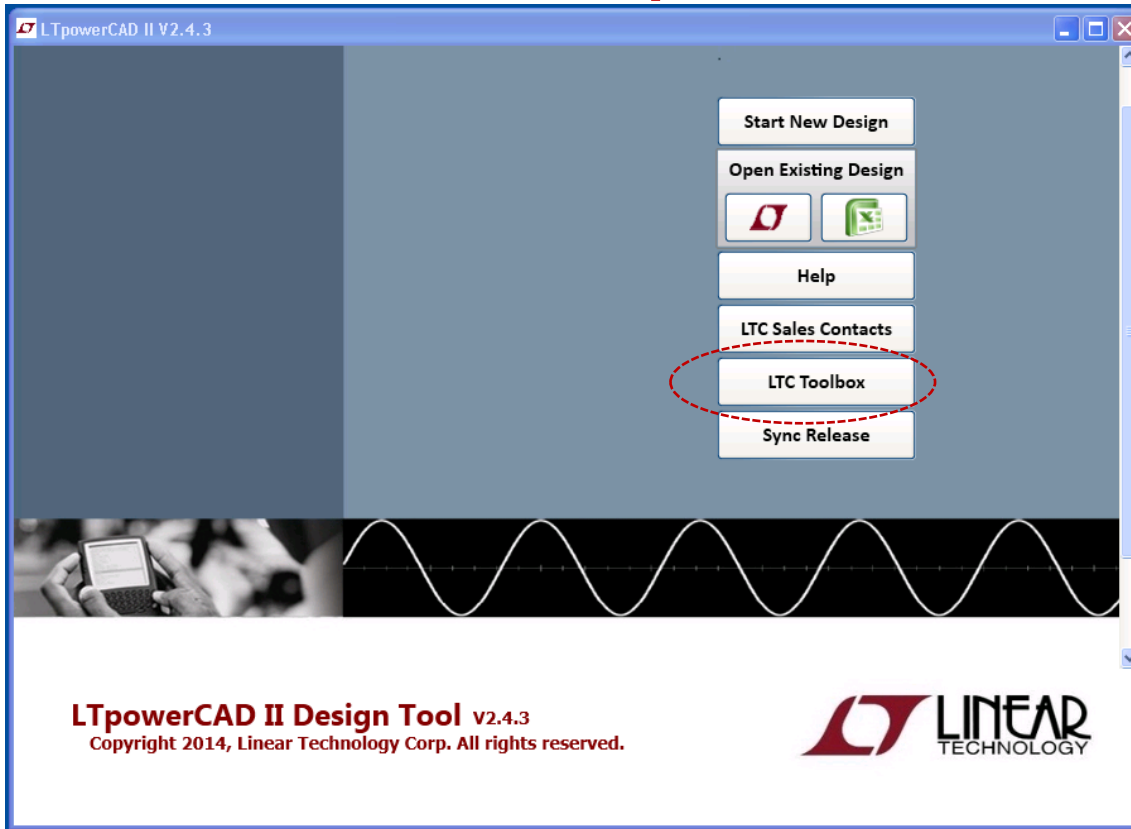

- Both **LTpowerPlanner III** and LTpowerPlanner II programs are listed.
- The previous LTpowerPlanner II program is NOT recommended for new designs.
- LTpowerCAD program is available at www.linear.com/LTpowerCAD

LTpowerPlanner™

Intuitive Power System Planning

Create System “Power Tree”

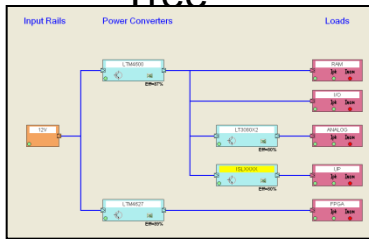

Design / Calculation

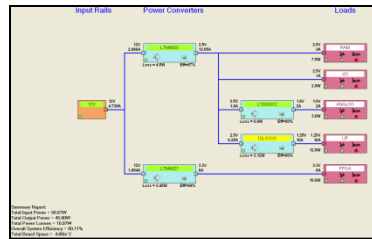

Save Design

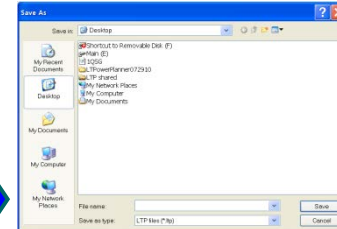

Print

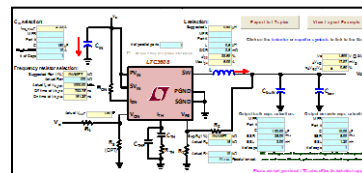
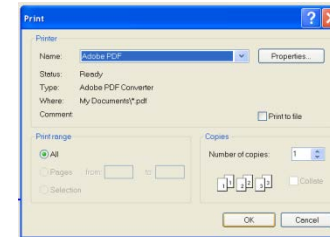

Interface With
LTpowerCAD™
Design Tool

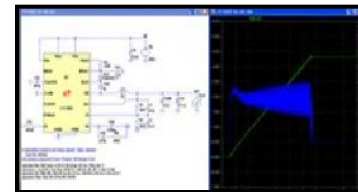

Interface With
LTspice™
Simulation Tool

LTpowerPlanner™

A Simple Design Example

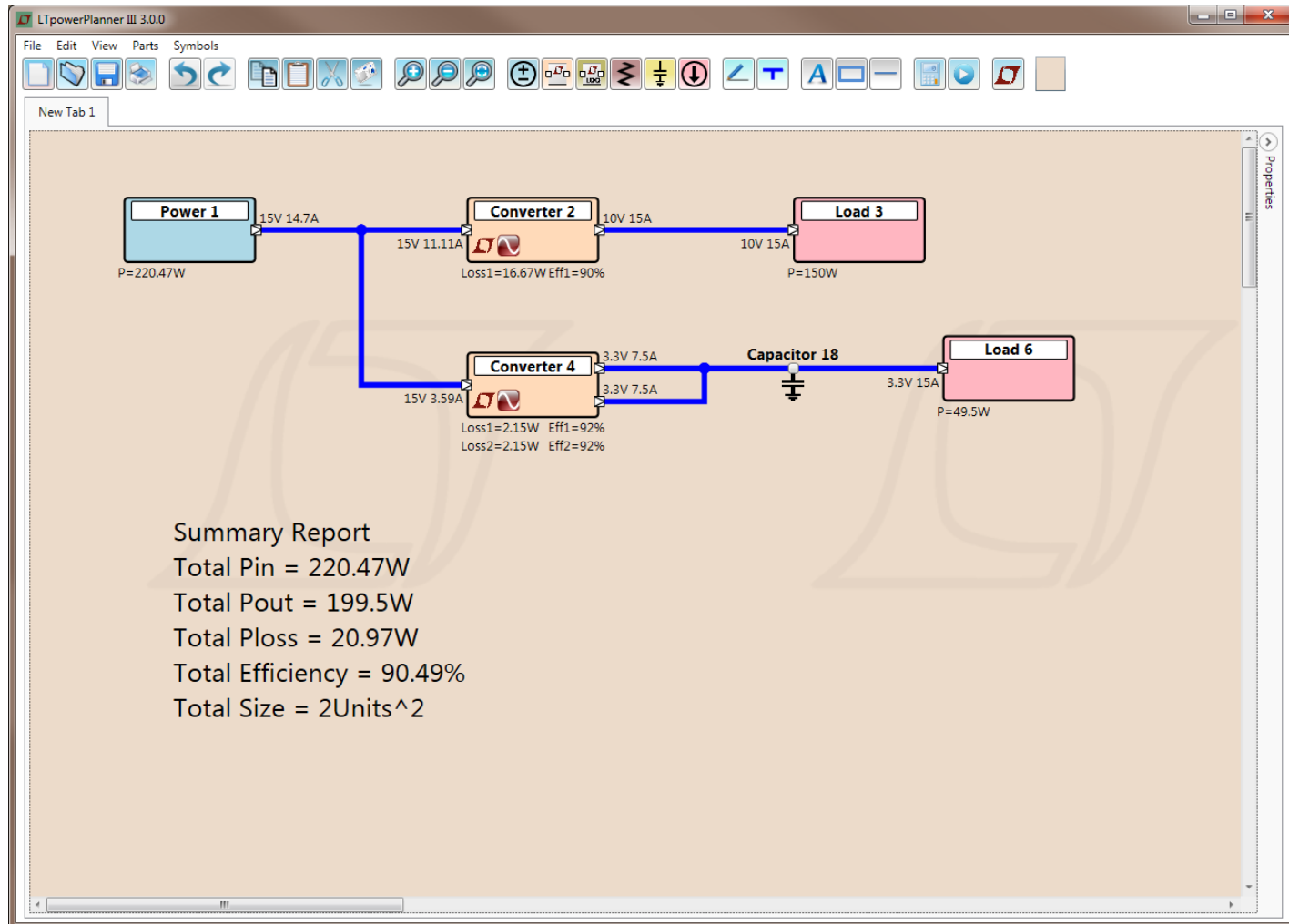

LTpowerPlanner™

Get Started with an Example

Main Screen

Toolbar
Tool Strip / Icons

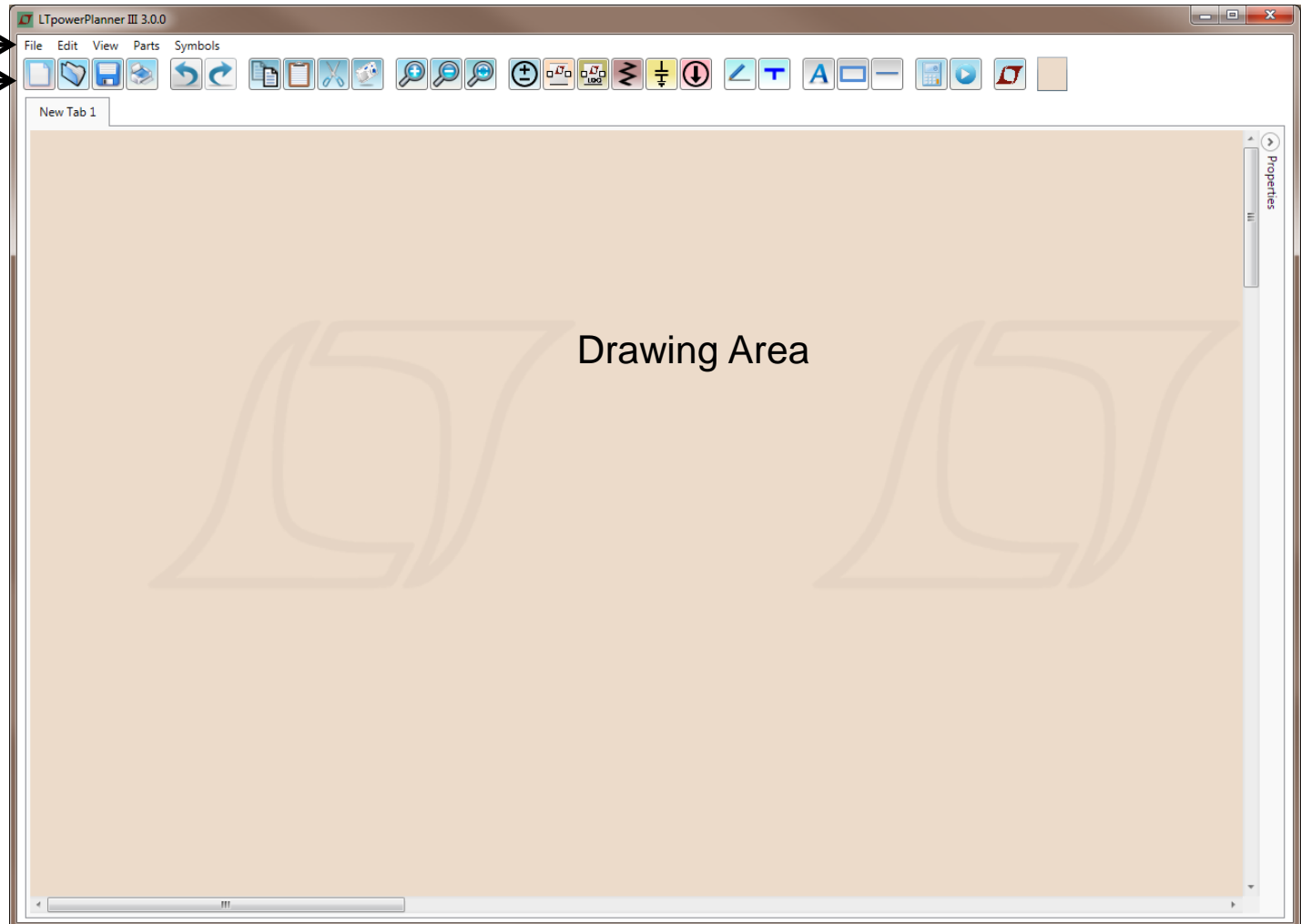

Components Toolbar

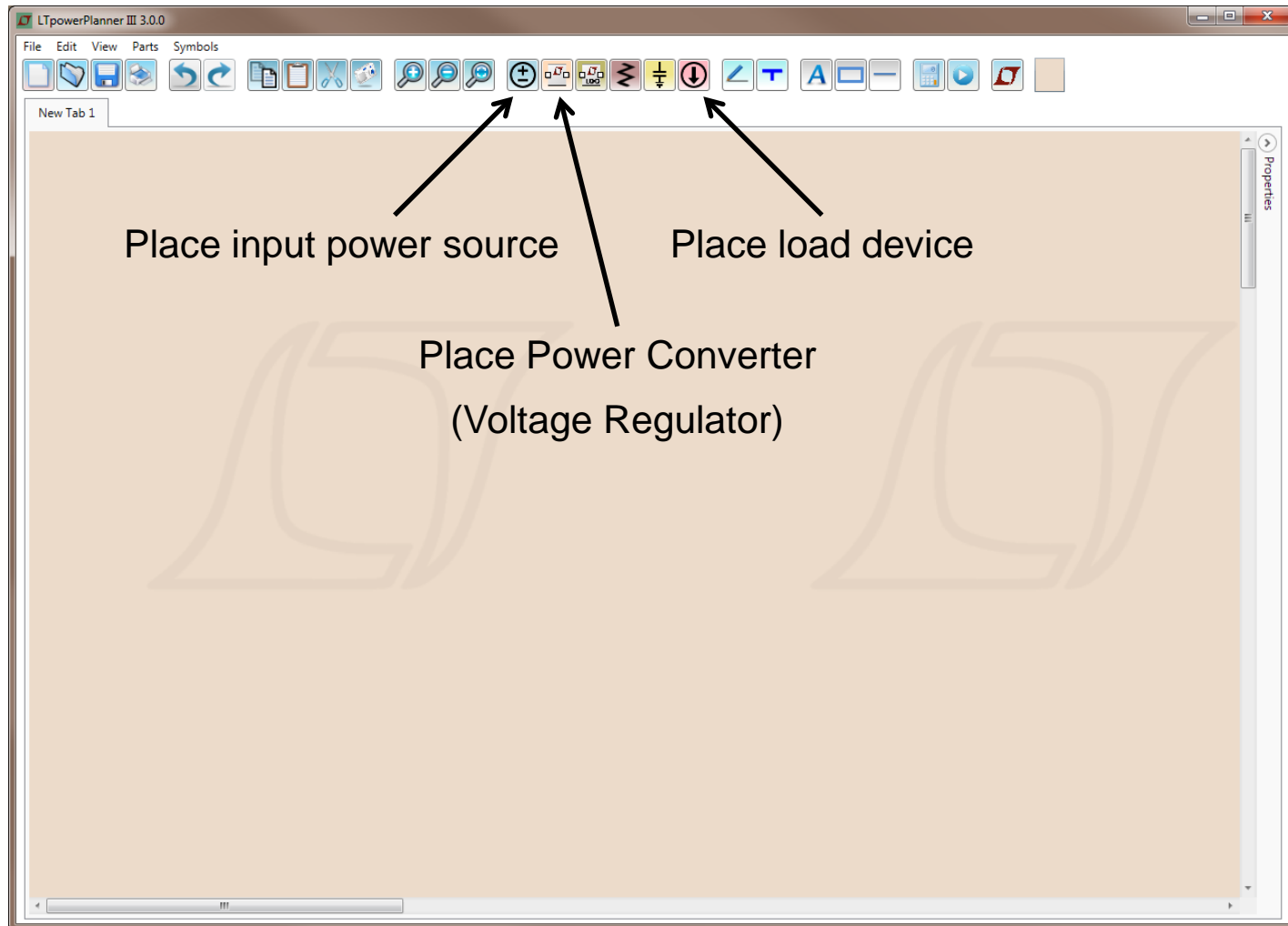

Components

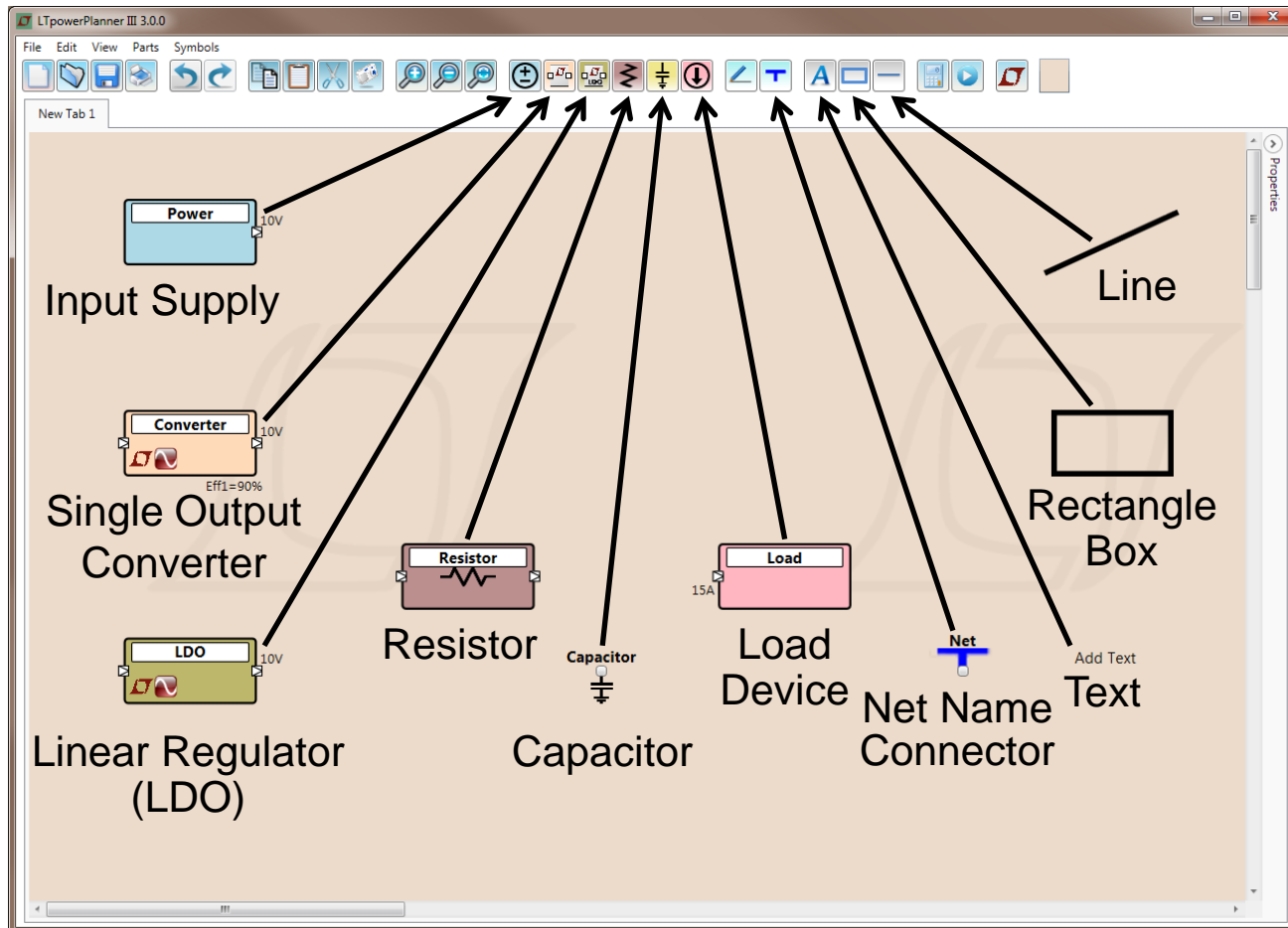

The Basics – Step 1: Add Parts

Click **Power, Converter or Load Icon** on the tool strip and drop the part onto the drawing area.

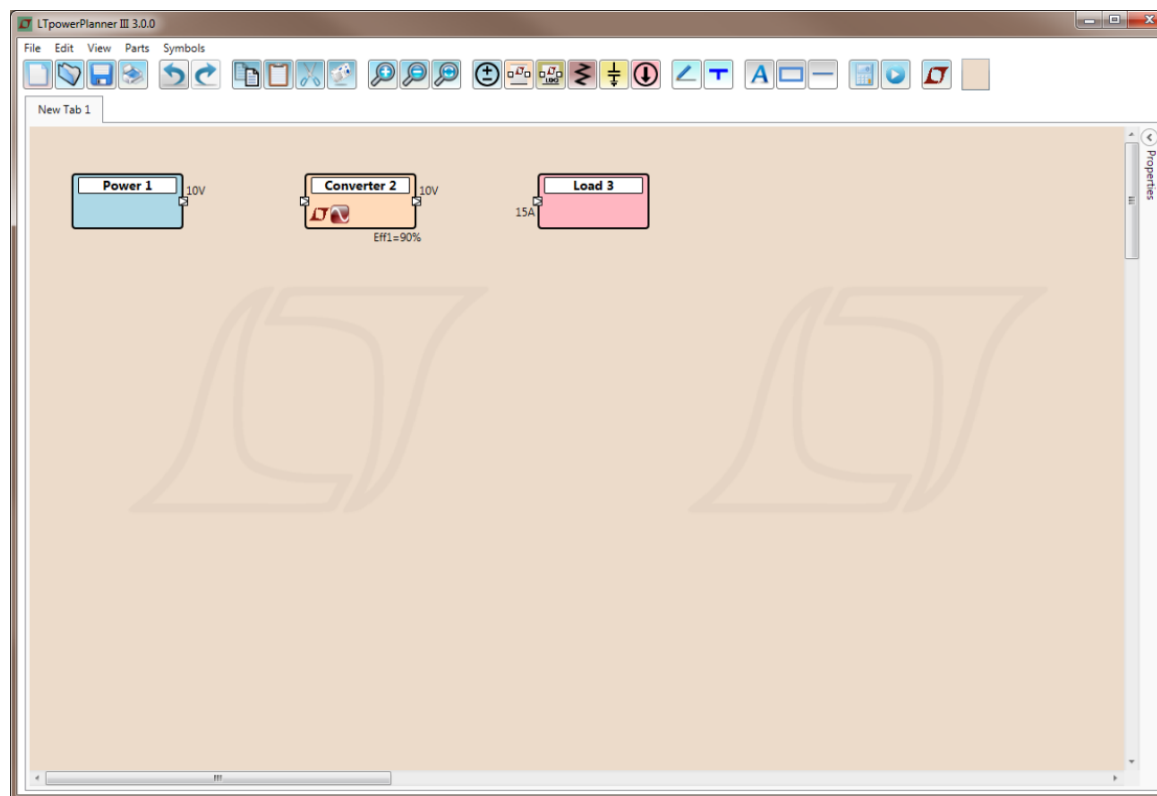

- By default, the input power source only has an output terminal. Converters have both input and output terminals. The load only has input terminals.
- **The input is always on the left side and the output is always on the right side.**

The Basics – Step 2: Make Connections

Add connections. Add a wire connecting Converter 2 to Load 3: **First click on the  Icon.** While in “Draw Wire” mode, the cursor will become a cross-hair. **Click Converter2’s output terminal.** Then release the mouse. **Next click on Load3’s input terminal** to create the wire. Right-click the Drawing Area to cancel “Draw Wire” mode.

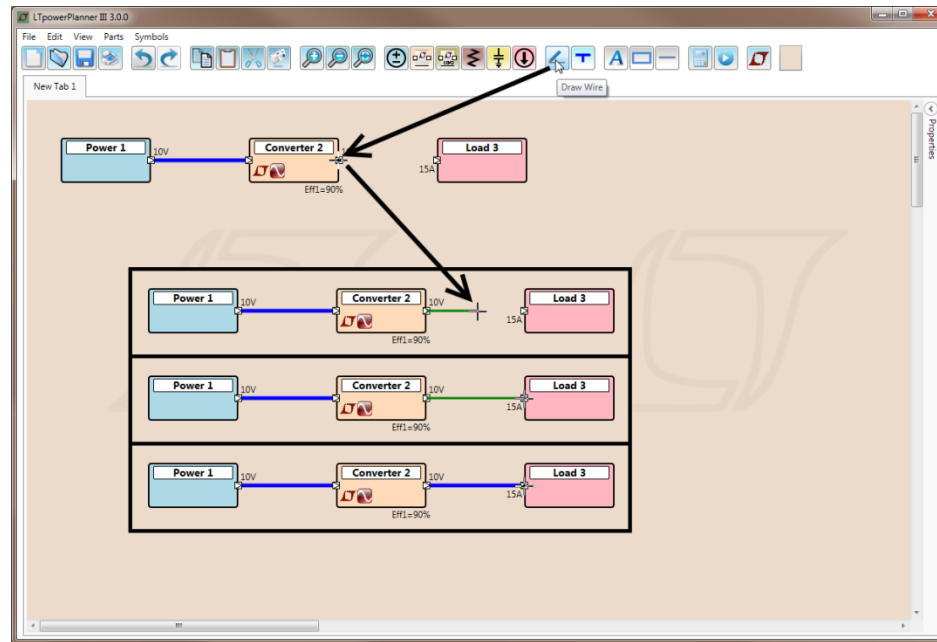

Notes:

1. Using an external mouse makes it easy to draw wires (instead of laptop PC touch pad/mouse)
2. The current program does **NOT** support “click-and-drag” to draw connection wire.
3. Routes requiring 90° turns must be placed by the user.

The Basics – Step 3: Part Properties

Change part properties. Double click on part labeled “Converter 2” to open the “Properties Tab”. Update the text box entries appropriate to the desired values.

The screenshot displays the LTpowerPlanner III 3.0.0 interface. The main workspace shows a circuit diagram with three components: 'Power 1' (10V), 'Converter 2' (10V, 15A, Eff1=90%), and 'Load 3'. A hand cursor is positioned over 'Converter 2', and a 'Double Click' label points to it. On the right, the 'Converter' properties tab is open, showing fields for Name, IC Part #, Vin Min (4.5 V), Vin Max (20 V), Topology (All), Converter Type (All), Output 1, Vout (10 V), Vout Min (2 V), Vout Max (15 V), Iout Max (15 A), Eff Nom (90%), and Eff Peak (95%). A red circle highlights a right-pointing arrow in the top right corner of the properties panel, with an arrow pointing to it from the text on the right.

Pressing this arrow will keep the “Properties Tab” always open or always closed when a single part is selected. Shortcut is “Space”

Note: the values with blue cell background color are used for power calculation or interface with LTpowerCAD search.

The Basics – Step 3: Part Properties

Each component has a unique “Properties” box which allows the appropriate fields to be edited.

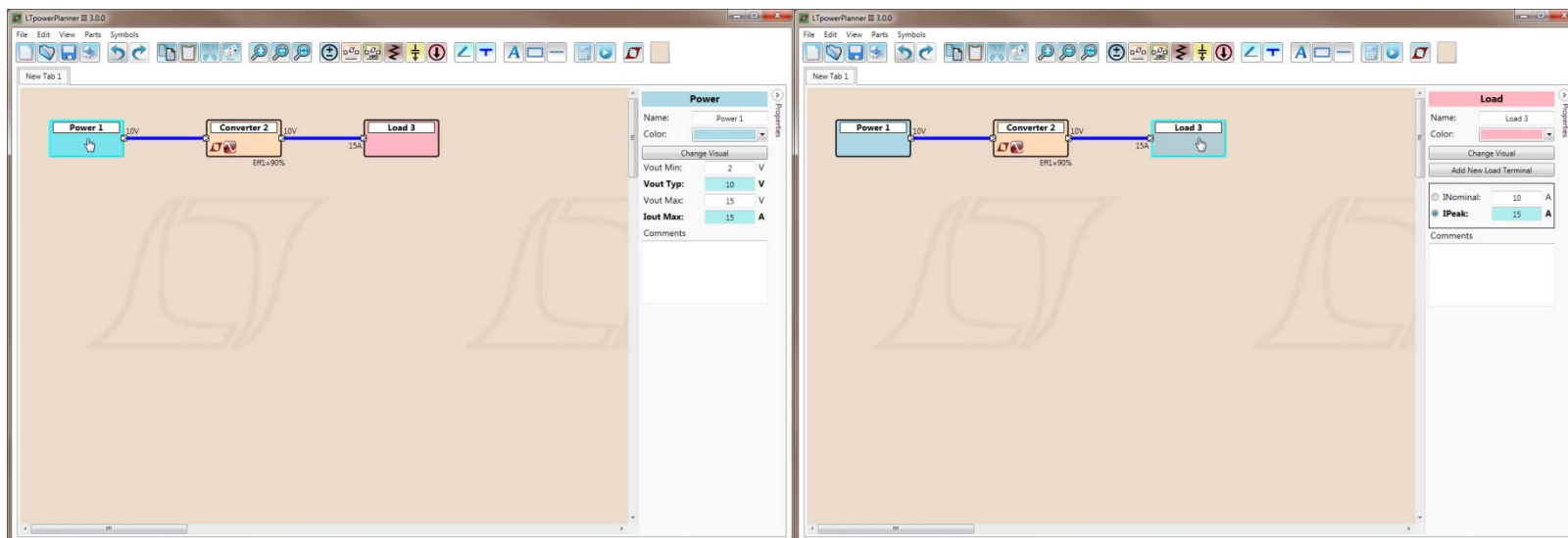

Power Source Properties

Load Device Properties

The Basics – Step 4: Calculate Parameters

Calculate parameters. Click the “Run” icon on the tool strip to calculate system efficiency, losses and total solution size.

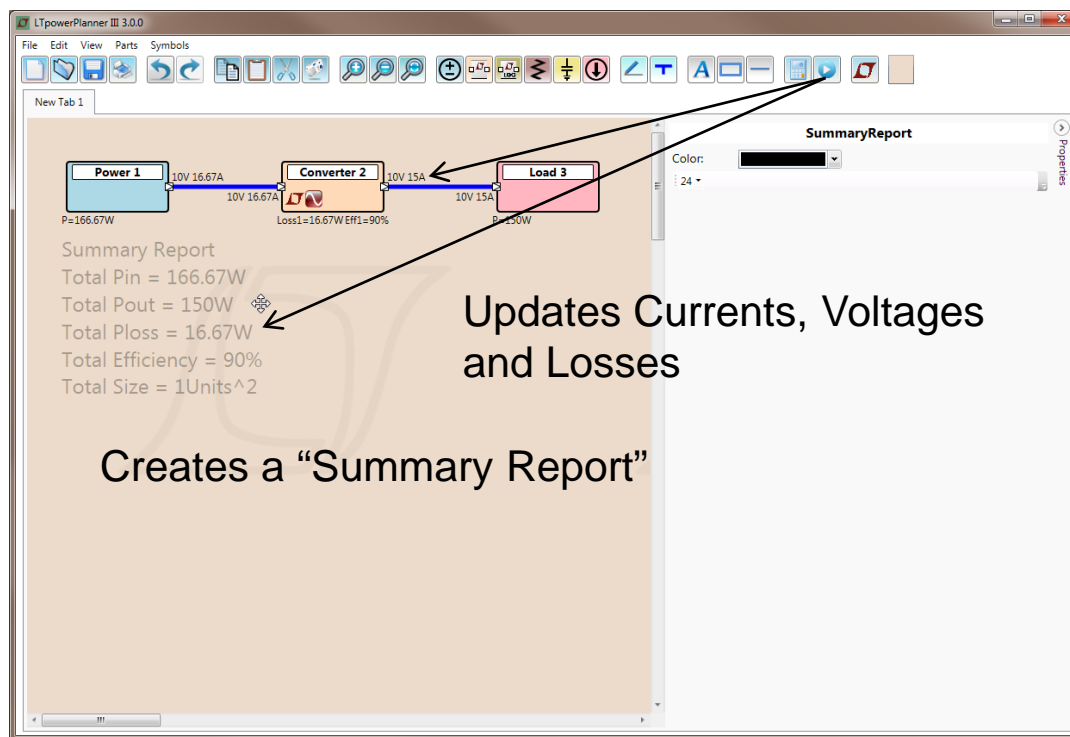

A design project is saved as an **.ltp3** file.

Note:

1. The user needs to **manually enter** the estimated efficiency and size of each converter to generate estimated total efficiency and board space.

Design Example – Functions & Features(1)

Move. Click and drag a part to move it to a new location. Dragging will snap parts in line with other parts and wire lines.

Step 1. Drag
(to select)

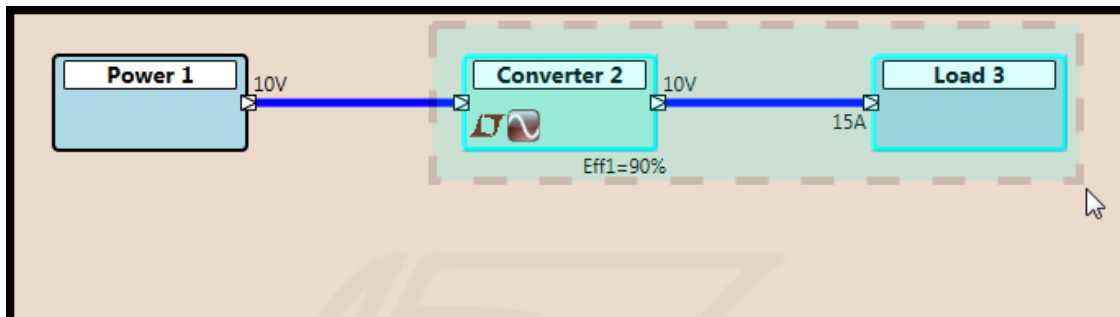

Step 2. Click & Hold
(to drag)

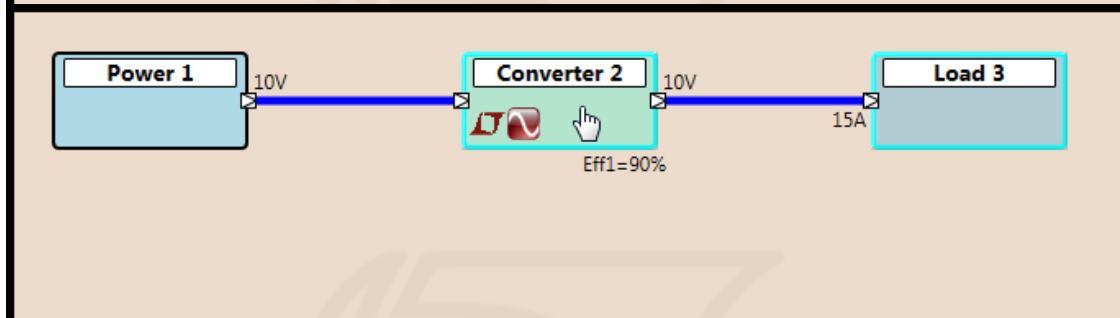

Step 3. Drag and Release
(to a new location)

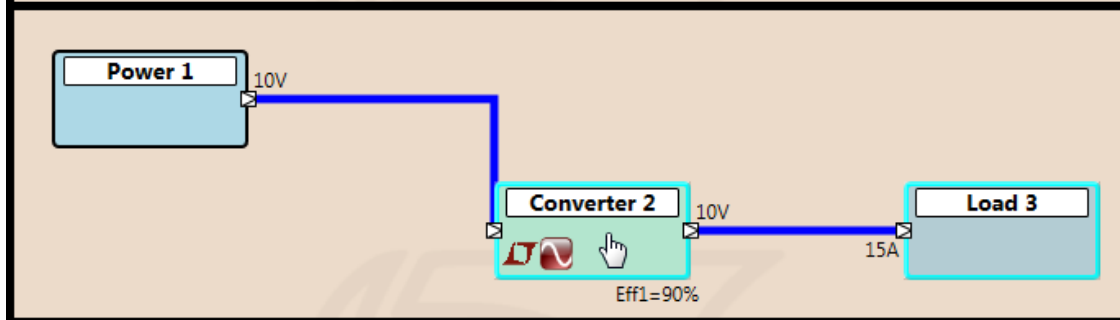

Design Example – Functions & Features(2)

Zoom. Click the “Zoom In” icon on the tool strip menu. This will increment the zoom by one step. “Zoom Out” is opposite this function. “Zoom to Fit” automatically sizes the zoom.

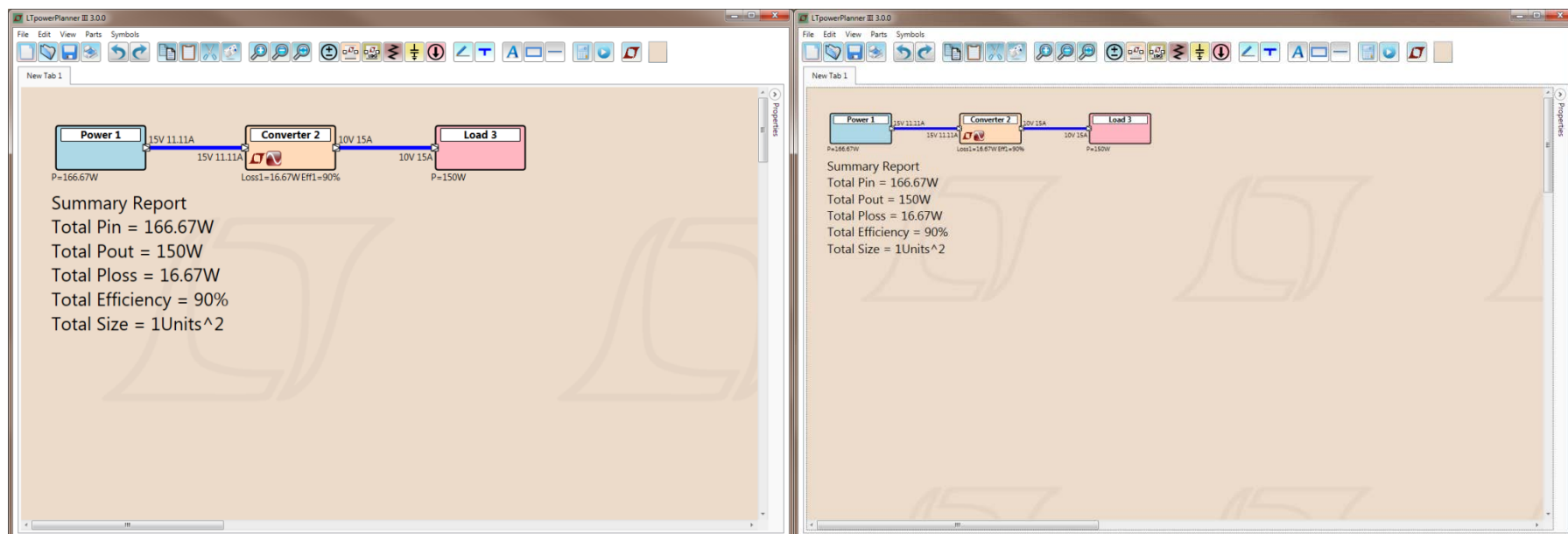

Design Example – Functions & Features(3)

Delete. Click the  icon to enter “Delete” Mode. **Deleting components** will automatically delete wires that are no longer relevant without the component. Right-click the Drawing Area to exit “Delete” mode.

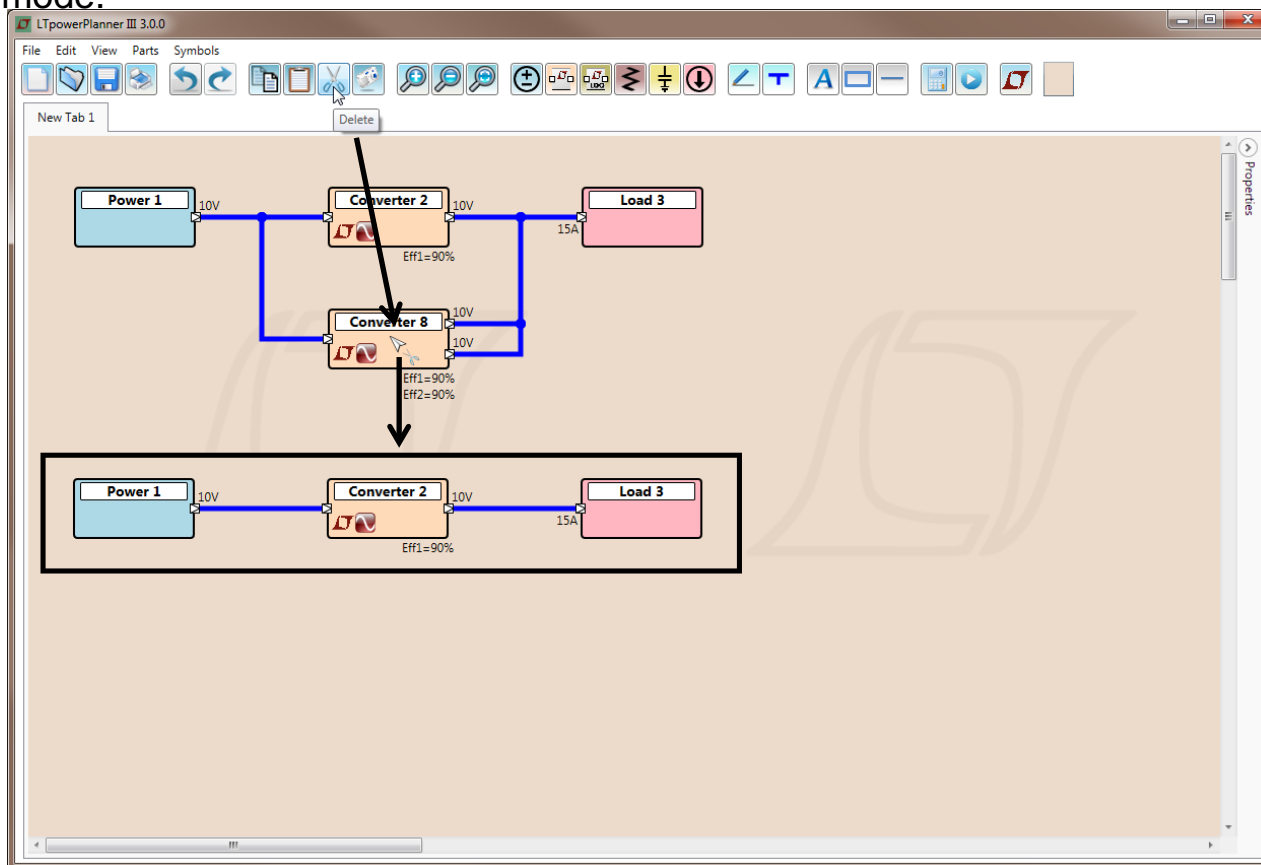

Design Example – Functions & Features(4)

Delete. Deleting a wire will automatically delete joining wires that are no longer relevant. Right-click the Drawing Area to exit “Delete” mode.

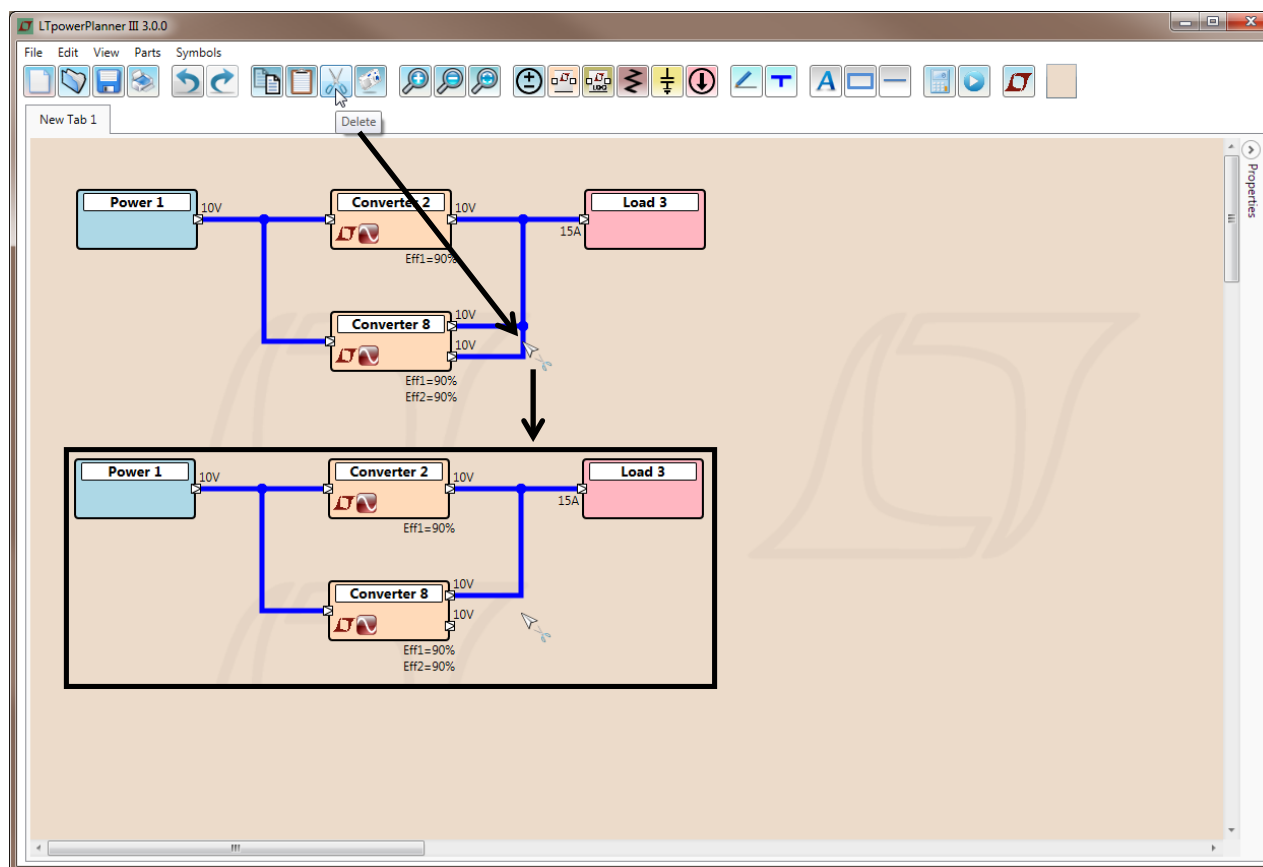

Advanced Functions – Drag Delete

Drag (Group) Delete. Delete groups of parts by dragging the Delete tool

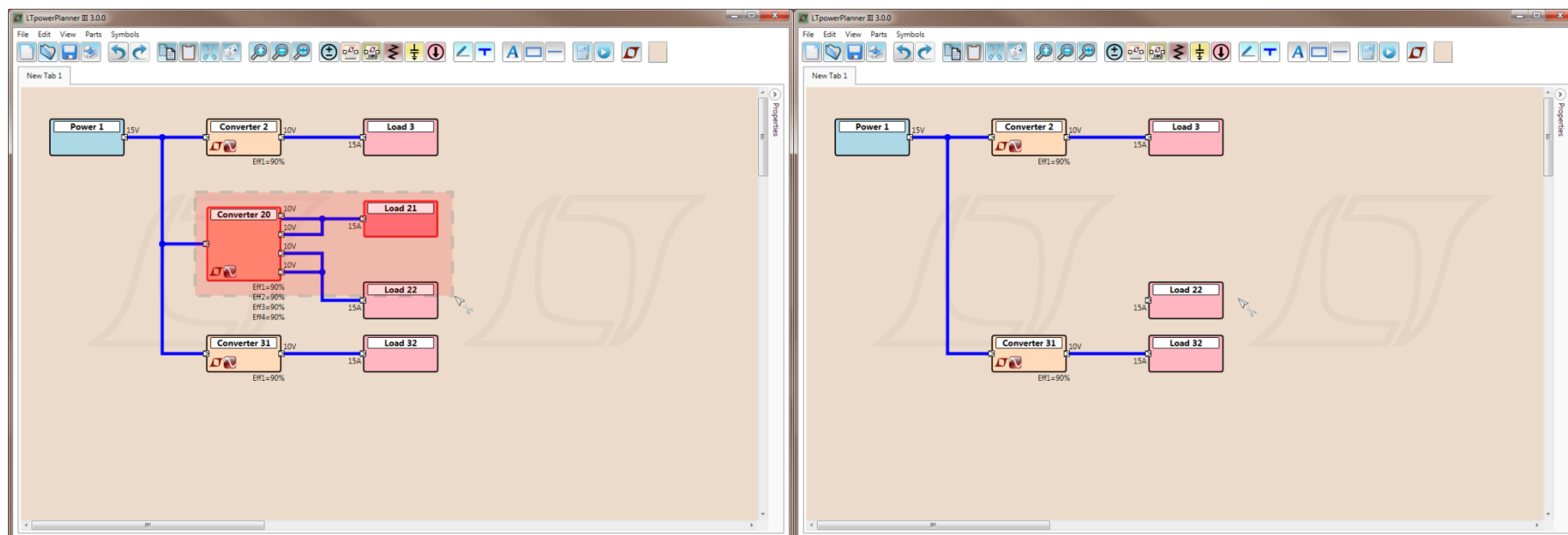

Design Example – Functions & Features(5)

Group Copy/Paste. Duplicates the selected components and their properties.

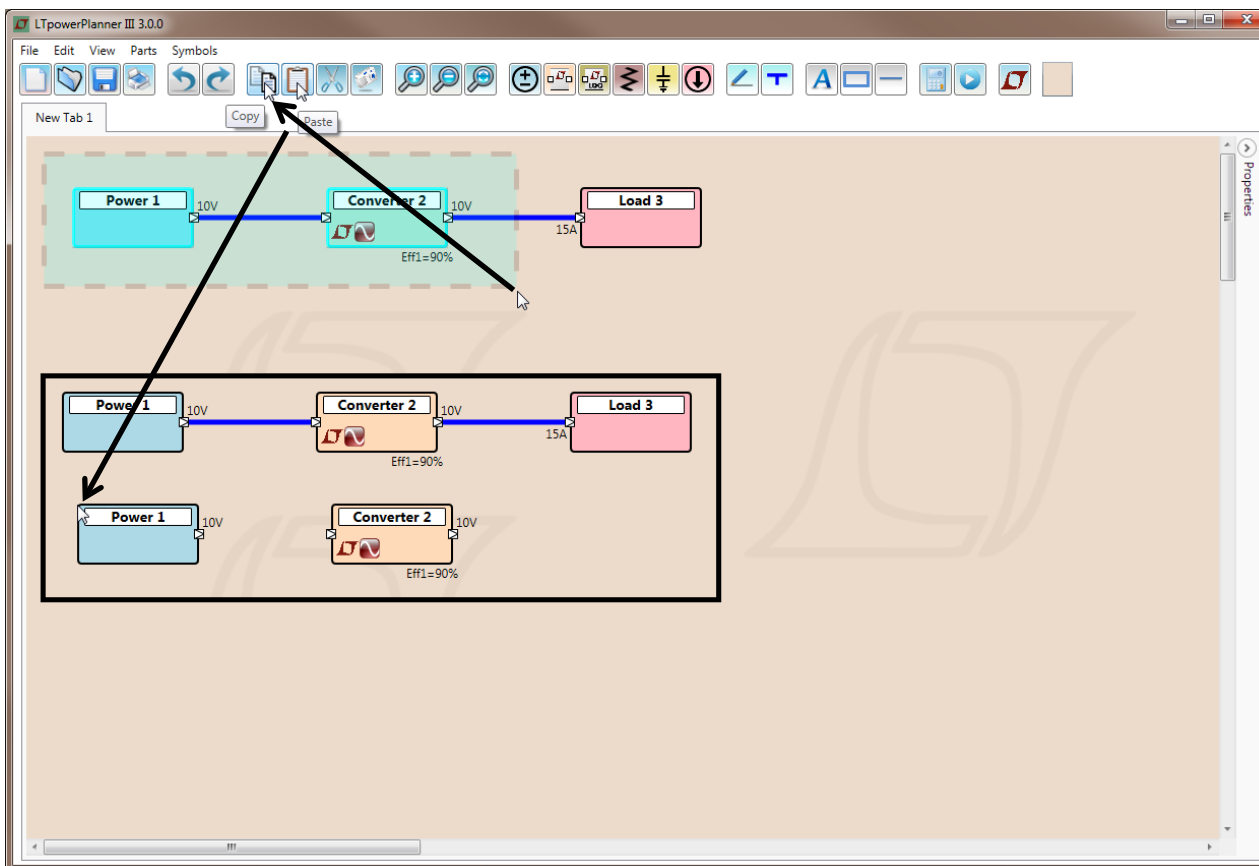

Note: copy/paste connection wires are not supported yet.

Design Example – Functions & Features(6)

Resize Component. Resize parts by dragging the corner of the part when the cursor changes to the resize icon. Rectangles, lines and text can be resized from multiple corners.

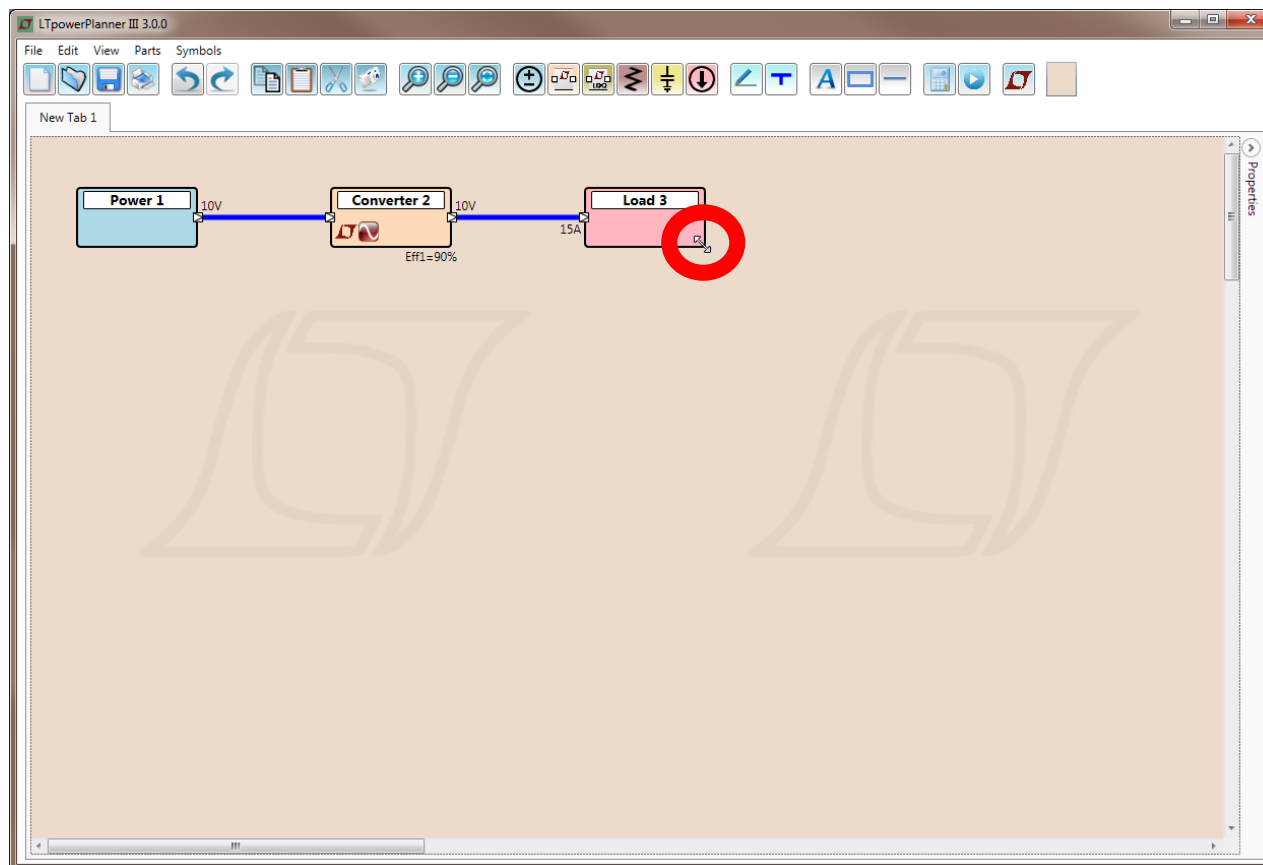

Design Example – Functions & Features(7)

Add Converter Output Terminals. Click the “+” button to add an output to the selected converter.

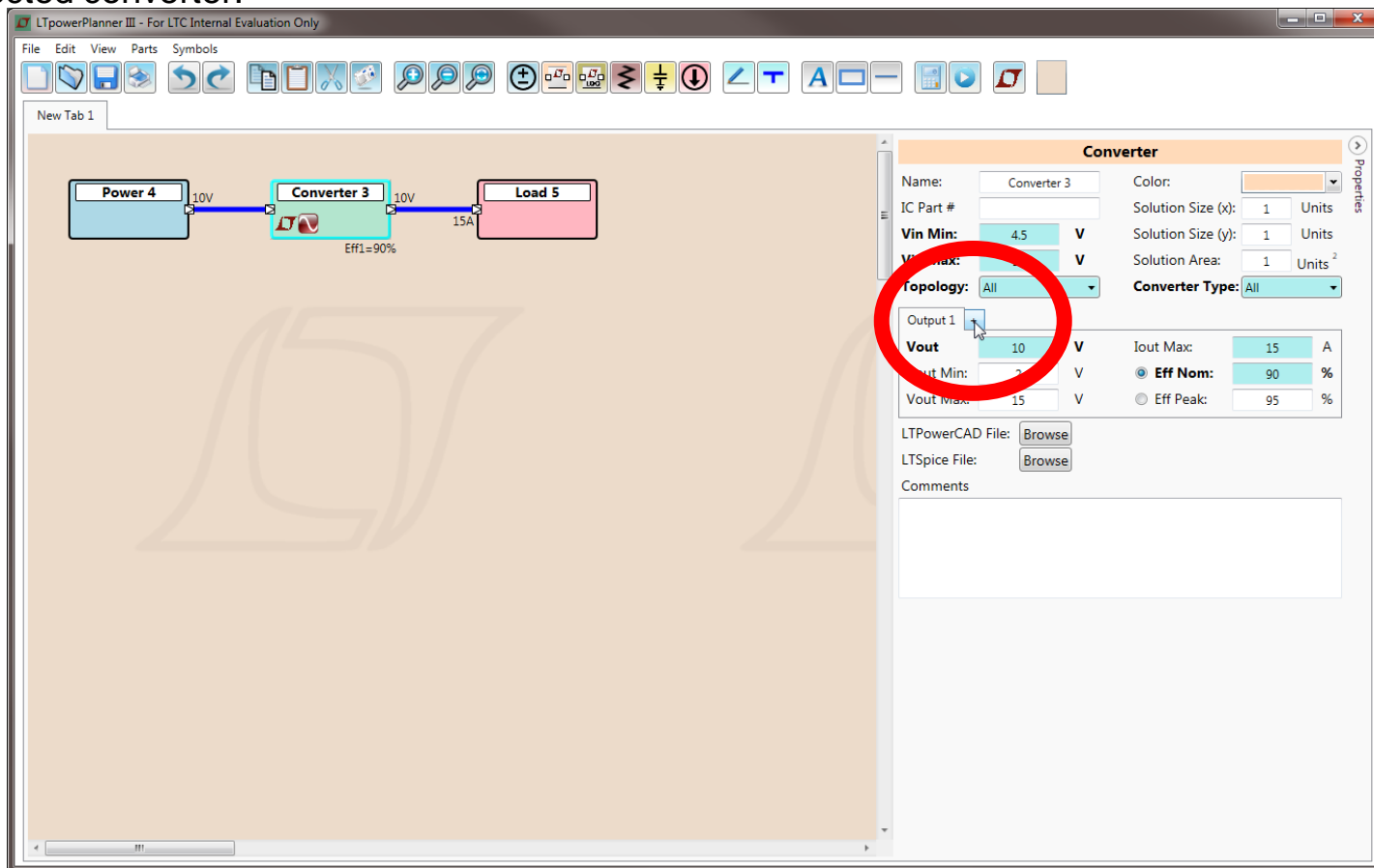

Design Example – Functions & Features(8)

Add Output Terminals. Each converter can have up to **8** outputs with separate efficiencies and output voltages.

The screenshot displays the LTpowerPlanner III software interface. The main workspace shows a schematic with a central 'Converter 3' block. It has a 'Power 4' input block on the left connected to its top terminal. On the right, 'Load 5' is connected to the top terminal, with a current of 15A indicated. The converter has eight output terminals, each labeled '10V'. Below the converter block, a list of efficiencies is shown: Eff1=90%, Eff2=90%, Eff3=90%, Eff4=90%, Eff5=90%, Eff6=90%, Eff7=90%, and Eff8=90%.

The right-hand panel, titled 'Converter', shows the configuration for 'Converter 3':

- Name: Converter 3
- Color: (orange)
- IC Part #: (empty)
- Solution Size (x): 1 Units
- Solution Size (y): 1 Units
- Solution Area: 1 Units²
- Topology: All
- Converter Type: All

Output 5	Output 6	Output 7	Output 8
Output 1	Output 2	Output 3	Output 4
Vout: 10 V		Iout Max: 15 A	
Vout Min: 2 V		<input checked="" type="radio"/> Eff Nom: 90 %	
Vout Max: 15 V		<input type="radio"/> Eff Peak: 95 %	

Below the configuration panel, there are fields for 'LTPowerCAD File:' and 'LTSpice File:', each with a 'Browse' button, and a 'Comments' text area.

Design Example – Functions & Features(9)

Add Load Input Terminals. Add an unlimited amount of Terminals to Load Parts by clicking the “Add New Load Terminal” button.

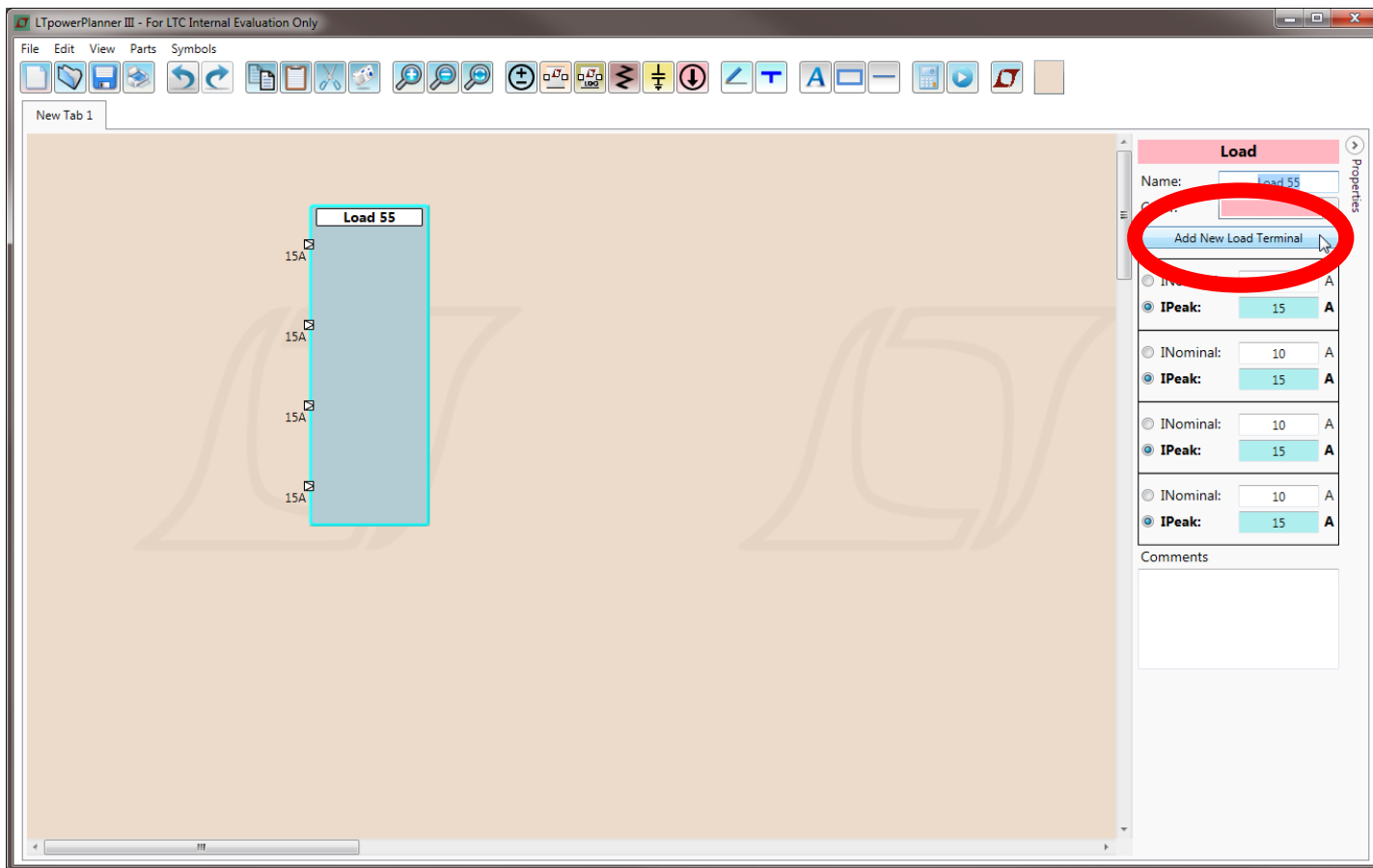

Design Example – Functions & Features(10)

Change Load Visual (Symbol). Change the appearance of Single Load Parts and Input Parts by clicking the “Change Visual” button.

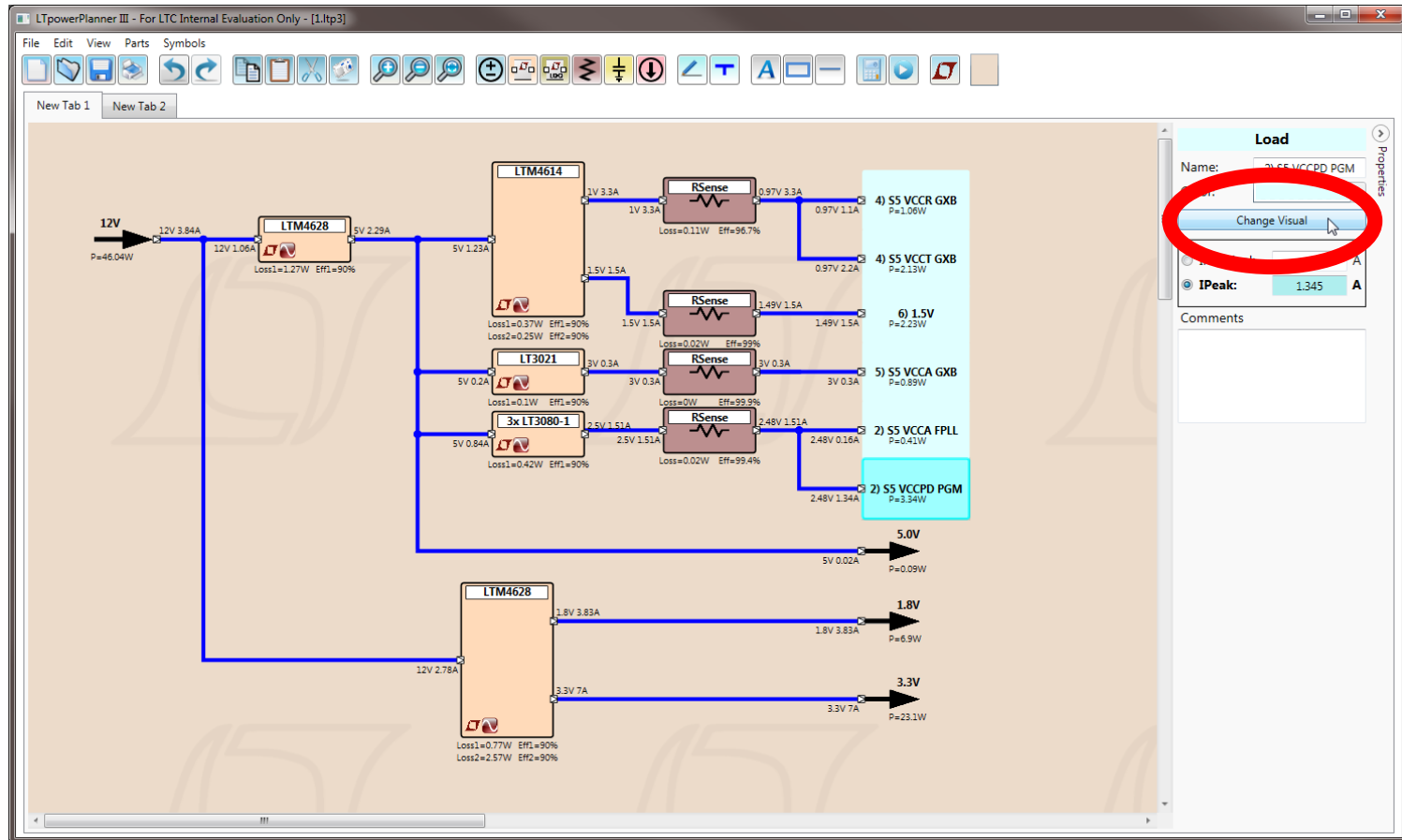

Design Example – Functions & Features(11)

Change Load Visual. Experiment with different sizes and configurations to achieve the desired appearance.

The screenshot displays the LTpowerPlanner III software interface. The main workspace is divided into two sections: "Input Visuals" on the left and "Load Visuals" on the right. The "Input Visuals" section contains three power sources labeled "Power 1", "Power 2", and "Power 3", each with a 10V label. The "Load Visuals" section contains ten load components labeled "Load 4" through "Load 10", each with a 15A label. A red arrow points from "Load 6" to "Load 10". The "Load 10" component is highlighted in cyan. On the right side, the "Properties" panel for "Load 10" is visible, showing fields for "Name" (Load 10), "Color" (a dropdown menu), and "Change Visual" button. Below these are radio buttons for "INominal" (10 A) and "IPeak" (15 A), with "IPeak" selected. A "Comments" text area is also present.

Stack this visual and change the color to create a multiple input load with individual labels

Design Example – Functions & Features(12)

Net Naming Part. Net naming parts with the same name are connected. This part cannot be connected by dropping onto existing wires. You have to manually connect wires to it to establish connections.

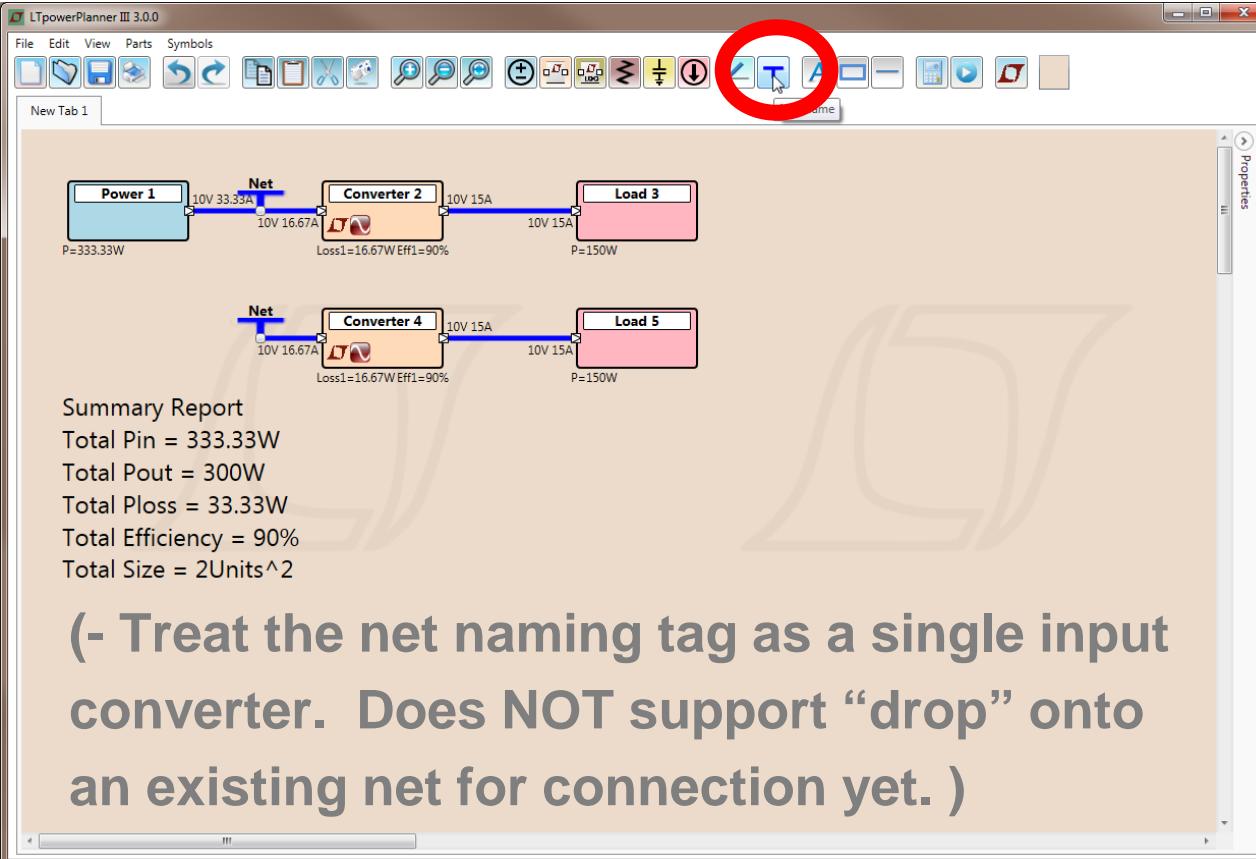

The screenshot shows the LTpowerPlanner III 3.0.0 software interface. The main workspace displays a circuit diagram with two power conversion stages. The top stage consists of a 'Power 1' block (P=333.33W) connected to a 'Net' block (10V 33.33A), which is then connected to 'Converter 2' (Loss1=16.67W Eff1=90%), and finally to 'Load 3' (P=150W). The bottom stage consists of a 'Net' block (10V 16.67A) connected to 'Converter 4' (Loss1=16.67W Eff1=90%), which is then connected to 'Load 5' (P=150W). A red circle highlights the 'Net Naming' tool in the toolbar. Below the diagram, a 'Summary Report' is displayed:

```

Summary Report
Total Pin = 333.33W
Total Pout = 300W
Total Ploss = 33.33W
Total Efficiency = 90%
Total Size = 2Units^2
  
```

(- Treat the net naming tag as a single input converter. Does NOT support “drop” onto an existing net for connection yet.)

Design Example – Functions & Features(13)

Copy an area of the drawing to image. Click the “Camera” icon. Left click and drag the cursor until the area covers the image you want to copy. This highlighted area of the drawing has been copied to the clipboard which can now be pasted elsewhere as a picture/image.

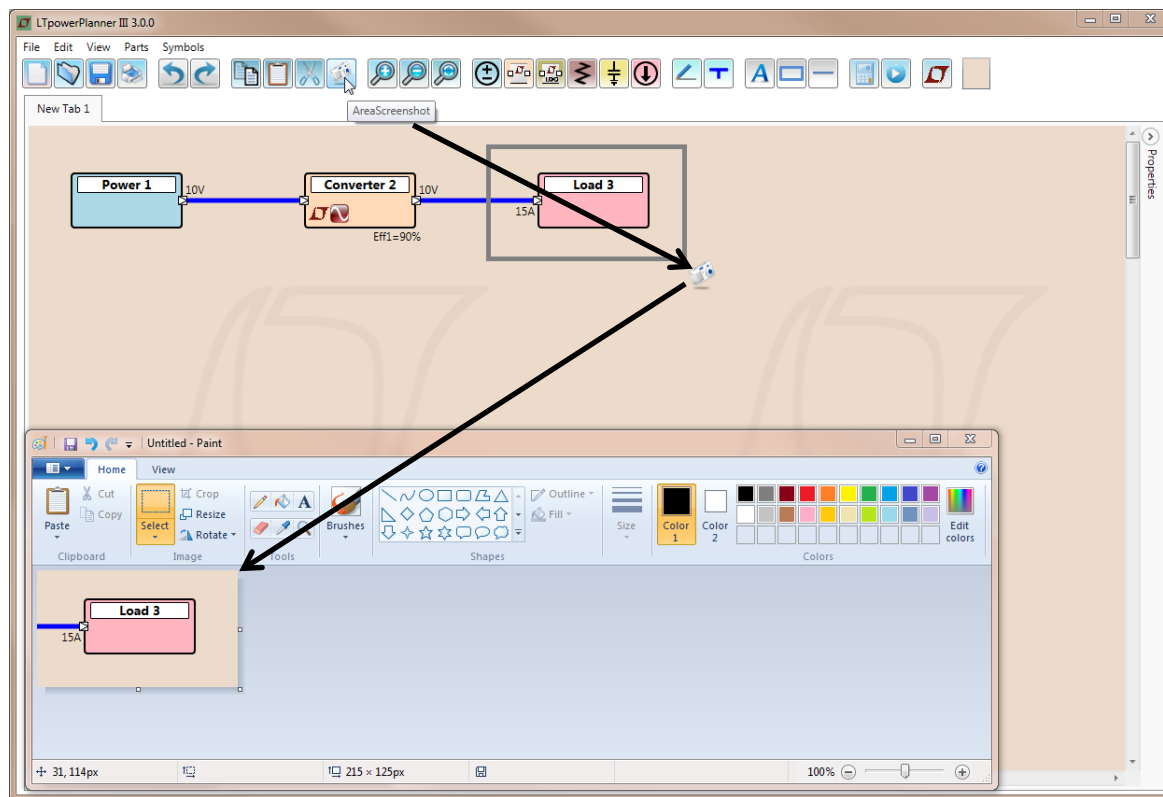

Design Example – Functions & Features(14)

Add text boxes and highlights. Icons from the Shapes group allow you to add commenting text and bring attention to specific areas.

The screenshot displays the LTpowerPlanner III 3.0.0 software interface. The main workspace shows a power flow diagram with three components: Power 1 (blue box), Converter 2 (orange box), and Load 3 (pink box). The diagram includes electrical parameters such as voltage (15V), current (11.11A, 15A), power (166.67W, 150W), and efficiency (90%). A dashed rectangular box highlights a 'Summary Report' with the following data:

- Summary Report
- Total Pin = 166.67W
- Total Pout = 150W
- Total Ploss = 16.67W
- Total Efficiency = 90%
- Total Size = 1Units^2

An arrow points to a 'Shapes Group' in the top toolbar, which contains icons for adding text boxes and highlights. Another arrow points to a text box containing the text 'Add comments and highlights!'.

- Note: the commenting text color, size and commenting line/rectangular box color and style can be changed in their properties window.

Design Example – Functions & Features(15)

New Tab. Click the “Page” icon to create a new tab. Each tab is included under the same project. Save will save all tabs into one project file.

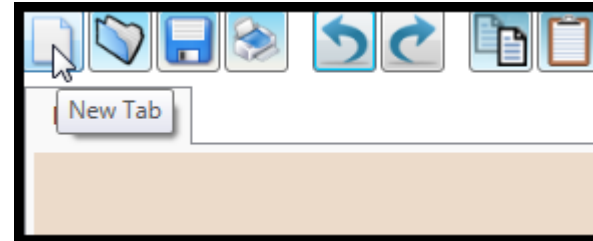

Rename Tab. Double click the Tab Name to rename the tab.

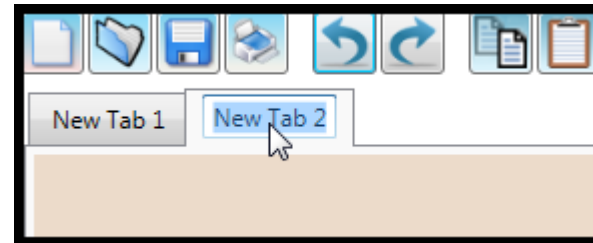

Delete Tab. Right click the Tab Name to bring up the delete option.



Design Example – Functions & Features(16)

Save/Open. “Save” and “Open” apply to ALL TABS! Each tab is designed to be a part of one solution. This means “Save” saves all your tabs to one file which has multiple tabs. When you “Open” a file, all your tabs will be replaced by the new project.

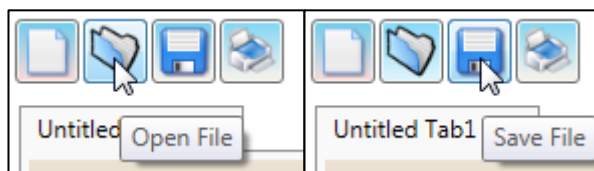

Print. Print will Zoom-to-Fit the current tab and open your printing options.

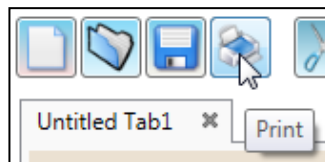

Undo/Redo.

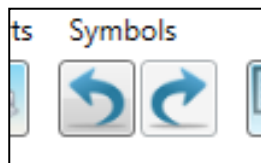

Design Example – Functions & Features(17)

Change Background Color. Click the “Color Switch” icon next to the “LTpowerCAD” icon. This will bring up a Color box that will let you change the color of the drawing area background.

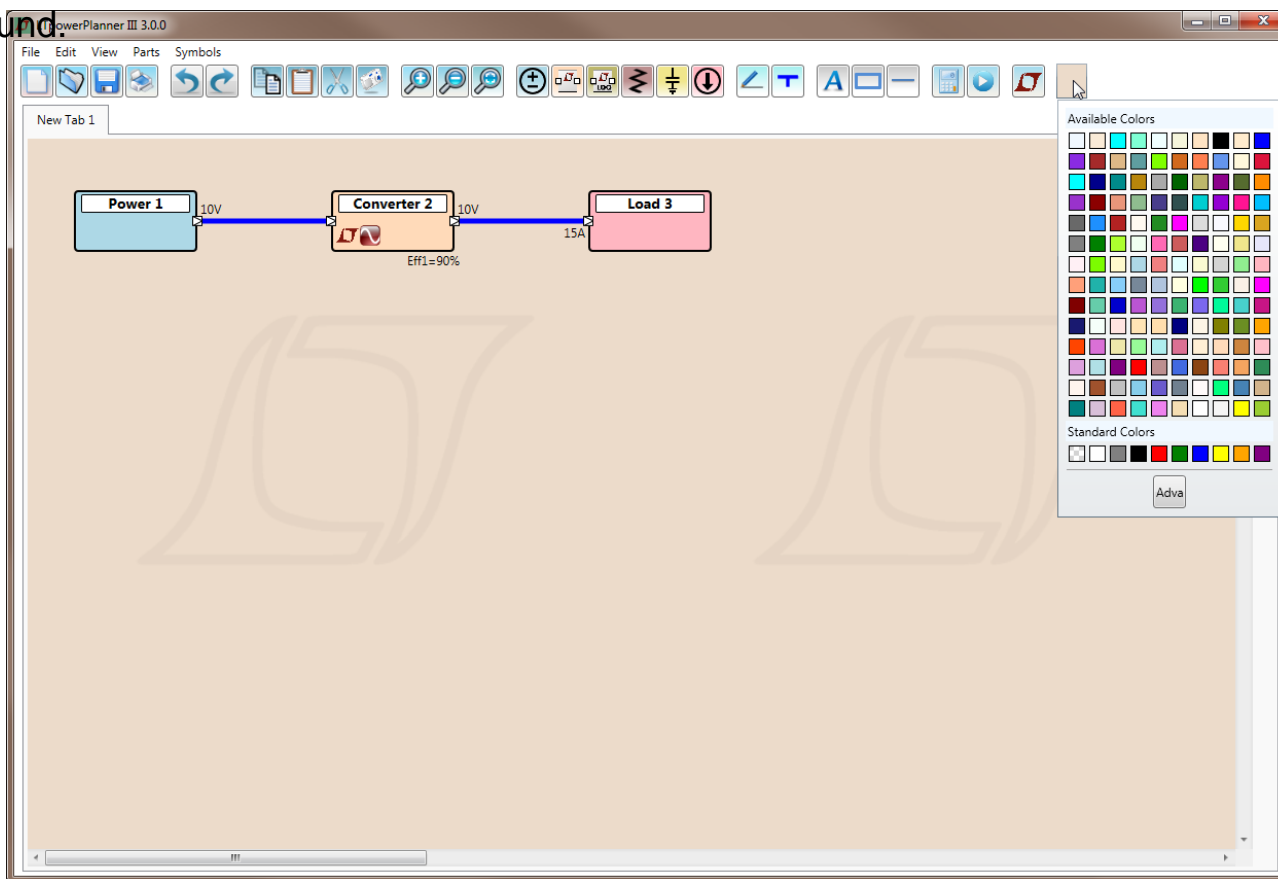

Design Example – Functions & Features(18)

Printing. Landscape printing is the default setting and can be changed in printing preferences.

The screenshot displays the LTpowerPlanner III interface. The main workspace shows two power converter designs. The top design consists of Power 4 (10V 33.33A, P=333.33W), Converter 3 (10V 16.67A, Loss1=16.67W Eff1=90%), and Load 5 (10V 15A, P=150W). The bottom design consists of Converter 62 (10V 16.67A, Loss1=16.67W Eff1=90%) and Load 63 (10V 15A, P=150W). A Summary Report on the right shows: Total Input Power: 333.33W, Total Output Power: 300W, Total Power Loss: 33.33W, and Total Efficiency: 90%.

Two dialog boxes are open. The 'Print' dialog box is in the foreground, showing printer selection options (e.g., HP LaserJet 4100) and page range settings. The 'Printing Preferences' dialog box is also open, with the 'Paper/Quality' tab selected. In this dialog, the 'Paper type' dropdown menu is open, and 'Landscape' is highlighted with a red circle, indicating it is the selected option.

Functions – Link LTspice/LTpowerCAD Files

Link Files. Click “Browse” in a converter’s Property Window to link an existing **LTSpice** or **LTPowerCAD** design file (previously created by user in a PC folder) to a specific converter.

The image displays two side-by-side screenshots of the Converter Property Window, illustrating the process of linking an external design file. Both windows show the same configuration for a converter named "Converter 2":

- Name:** Converter 2
- Color:** (Dropdown menu)
- IC Part #:** (Empty field)
- Solution Size (x):** 1 Units
- Solution Size (y):** 1 Units
- Solution Area:** 1 Units²
- Converter Type:** All
- Topology:** All
- Vin Min:** 4.5 V
- Vin Max:** 20 V
- Output 1:**
 - Vout:** 10 V
 - Vout Min:** 2 V
 - Vout Max:** 15 V
 - Iout Max:** 15 A
 - Eff Nom:** 90 %
 - Eff Peak:** 95 %

In the left window, the "LTPowerCAD File:" field has a "Browse" button next to it. In the right window, this field is populated with "ExampleLTPCFile.ltpc". Below this field is another "Browse" button for the "LTSpice File:" field. To the right of the property windows, a circuit diagram shows two "Converter 2" blocks. Each block has a 10V output terminal and an efficiency indicator "Eff1=90%". Arrows point from the "ExampleLTPCFile.ltpc" text in the right window to the top converter block, and from the "Browse" button in the right window to the bottom converter block.

Open Linked Design / Simulation files. Click the LTPowerCAD or LTSpice button to open the linked files.

Functions – Open LTpowerCAD Parametric Search

Parametric Search. Clicking the LTpowerCAD button **without** a linked file will open LTpowerCAD's parametric search using parameters pulled from the LTpowerPlanner converter. Clicking LTspice without a linked file will open a new LTspice window.

The screenshot displays the LTpowerCAD II V2.4.3 interface. On the left, a 'Converter' window is open, showing a schematic of 'Converter 2' with a 10V output and 90% efficiency. Below the schematic, the 'Converter' configuration panel is visible, with fields for Name, IC Part #, Vin Min (4.5 V), Vin Max (20 V), Topology (All), Converter Type (All), Output 1 (Vout 10 V), Vout Min (2 V), Vout Max (15 V), Iout Max (15 A), Eff Nom (90%), and Eff Peak (95%). A 'Browse' button is next to the LTPowerCAD File field. The main LTpowerCAD window shows the 'Converter Specification' section with fields for Converter Topology (BuckBoost), Converter Type (All), Output Rail 1 (Vout1 10 V, Iout1 15 A), Min. Input Voltage (4.5 V), Nom. Input Voltage (12.25 V), Max. Input Voltage (20 V), Num. of Output Rails (One), and Num. of Parallel Phases (1). The 'Optional Features' section includes checkboxes for Burst Mode, Synchronous FET, Isolated, Run / Enable, Sync. to External Clock, Output Voltage Tracking, Remote Voltage Sensing, Margin Control, Power Good Monitor, Poly-phase / Load Share, and I2C/PMBus Interface. The 'Search' section has buttons for Search Parts, All Parts, and LTC Web Search, along with checkboxes for Search Designer's Tools Only and Always Keep Search Page Open. A table at the bottom shows search results for parts LTC3780 and LTC3789.

Design Tool	Website	Part #	Type	Description	Topology	IC Max Vin	IC Min Vin
	LTC Web	LTC3780	Controller	High Efficiency, Synchronous, 4-Switch Buck-Boost Con	Buck-Boost	36	4
	LTC Web	LTC3789	Controller	High Efficiency, Synchronous, 4-Switch Buck-Boost Con	Buck-Boost	38	4

LTpowerCAD currently supports design tools for a limited number of parts. For more part options click the LTC Web Search button.

Advanced Functions – Wire Snapping

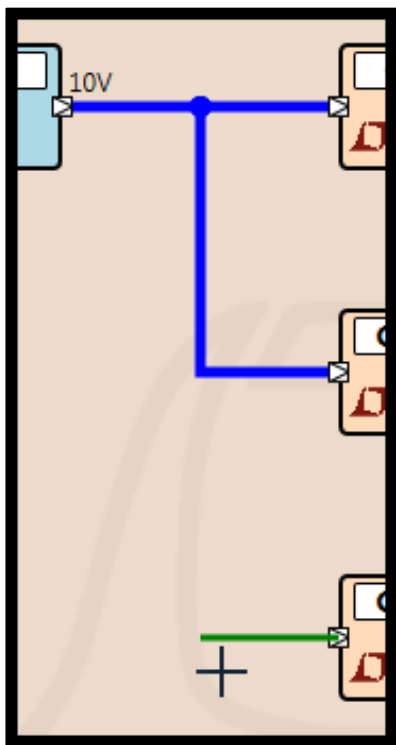

Snaps left of cursor location
to line up with the corner

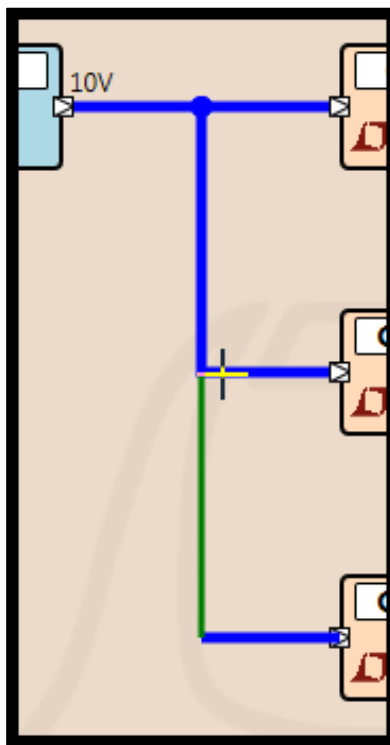

Must click wire to make
connection, even though it
snaps to the correct place

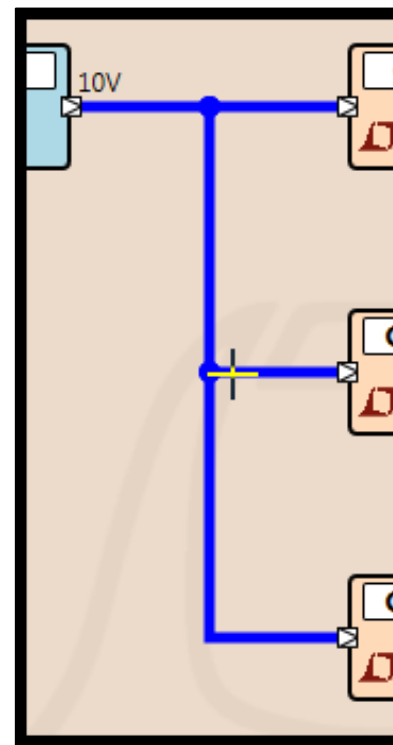

Easy clean connection

Drawing wires will snap to corners for easier and cleaner connections

Advanced Functions – Keybindings & Shortcuts

- ◆ Ctrl + N = New Tab
- ◆ Ctrl + O = Open File
- ◆ Ctrl + S = Save File
- ◆ Ctrl + Shift + S = Save File As
- ◆ Ctrl + P = Print

- ◆ Delete = Delete Mode
- ◆ Ctrl + C = Copy/Paste Mode
- ◆ W = Wiring Mode
- ◆ B = Run Calculation

- ◆ I = Draw Line
- ◆ A = Draw Arrow
- ◆ E = Draw Rectangle
- ◆ T = Text

- ◆ Space = Open/Close Properties Tab
- ◆ P = Create Power
- ◆ S = Create Single Converter
- ◆ D = Create Dual Converter
- ◆ R = Create Resistor
- ◆ O = Create LDO Converter
- ◆ C = Create Capacitor
- ◆ L = Create Load

- ◆ - or Ctrl + Scroll Down = Zoom Out
- ◆ = or Ctrl + Scroll Up = Zoom In
- ◆ 0 = Zoom Fit
- ◆ Scroll = Vertical Scroll
- ◆ Shift + Scroll = Horizontal Scroll

Backward Compatibility with LTpowerPlanner Rev.2.

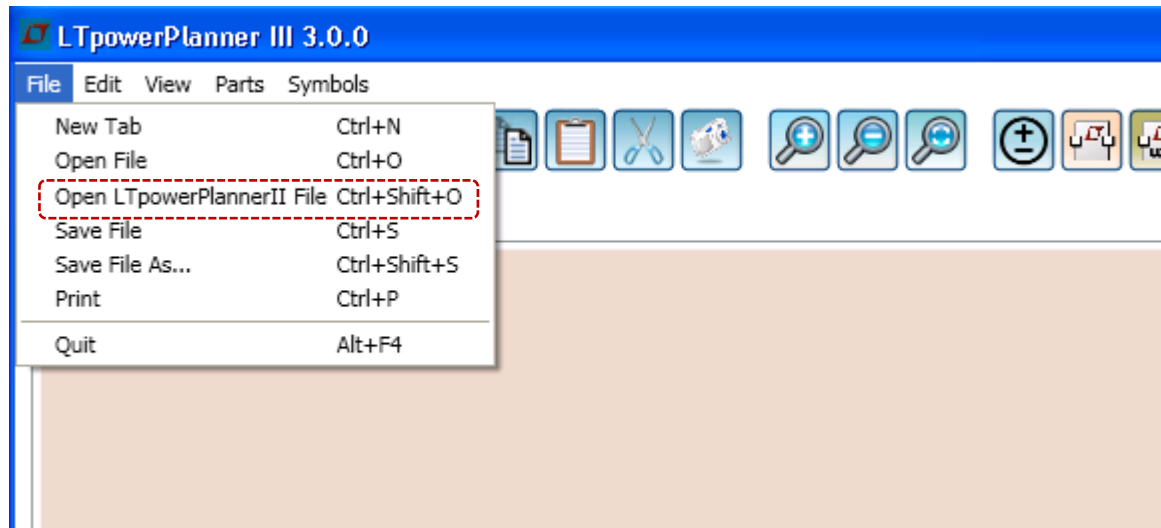

- Due to the major program structure change, the LTpowerPlanner III can open the LTpowerPlanner II project files. Only the components are imported. The wiring connection is not imported.
- We will keep the backward compatibility for future LTpowerPlanner III and beyond program versions.

Future Functions – In Development

In Development:

- **Delete Extra Input/Output Terminals**
- **Group Copy/Paste with Wiring**
- **Support Negative Output Voltage**
- **Support Multiple Output LDO**

Thank You

Now you have gone through the main features of the program and are ready to use LTpowerPlanner™ !

There are still more features to explore...

Questions? Suggestions?
Email to: LTpowerCAD@linear.com

Looking for pricing, stock, or lifecycle information?

Click below to explore more details on WIN SOURCE:

- ⊖ [View LTC3786IMSE#TRPBF on WIN SOURCE](#)
- ⊖ [Analog Devices Inc. Information](#)

Optimize Your Supply Chain with WIN SOURCE Solutions

- ✓ Global Sourcing Solution
- ✓ Obsolete Management
- ✓ Cost Control Management
- ✓ Shortage Management
- ✓ Alternative Solution
- ✓ Excess Inventory Management