



**THE DATASHEET OF  
LTC6242HVIGN#TRPBF**



## FEATURES

- **0.1Hz to 10Hz Noise: 550nV<sub>p-p</sub>**
- **Input Bias Current:**  
     **0.2pA (Typ at 25°C)**  
     **1pA Max (LTC6240)**
- **Low Offset Voltage: 125µV Max**
- **Low Offset Drift: 2.5µV/°C Max**
- **Gain Bandwidth Product: 18MHz**
- **Output Swings Rail-to-Rail**
- **Supply Operation:**  
     2.8V to 6V LTC6240/LTC6241/LTC6242  
     2.8V to ±5.5V LTC6240HV/LTC6241HV/LTC6242HV
- **Low Input Capacitance**
- **H-Grade Temperature Range: -40°C to 125°C**
- **Single LTC6240 in 5-Pin Low Profile (1mm) ThinSOT™ Package and 8-Pin SO for PCB Guard Ring**
- **Dual LTC6241 in 8-Pin SO and Tiny DFN Packages**
- **Quad LTC6242 in 16-Pin SSOP and 5mm × 3mm DFN Packages**

## APPLICATIONS

- Photo Diode Amplifiers
- Charge Coupled Amplifiers
- Low Noise Signal Processing
- Medical Instrumentation
- High Impedance Transducer Amplifier

## DESCRIPTION

The LTC®6240/6241/LTC6242 are single, dual and quad low noise, low offset, rail-to-rail output, unity gain stable CMOS op amps that feature 1pA of input bias current. Input bias current is guaranteed to be 1pA max on the single LTC6240. The 0.1Hz to 10Hz noise of only 550nV<sub>p-p</sub>, along with an offset of just 125µV are significant improvements over traditional CMOS op amps. Additionally, noise is guaranteed to be less than 10nV/√Hz at 1kHz. An 18MHz gain bandwidth, and 10V/µs slew rate, along with the wide supply range and low input capacitance, make them perfect for use as fast signal processing amplifiers.

These op amps have an output stage that swings within 30mV of either supply rail to maximize the signal dynamic range in low supply applications. The input common mode range extends to the negative supply. They are fully specified on 3V and 5V, and an HV version guarantees operation on supplies up to ±5V.

The LTC6240 is available in the 8-pin SO and the 5-pin SOT-23 packages. The LTC6241 is available in the 8-pin SO, and for compact designs it is packaged in a tiny dual fine pitch leadless (DFN) package. The LTC6242 is available in the 16-pin SSOP as well as the 5mm × 3mm DFN package.

LT, LT, LTC, LTM, Linear Technology and the Linear logo are registered trademarks of Linear Technology Corporation. ThinSOT is a trademark of Linear Technology Corporation. All other trademarks are the property of their respective owners.

## TYPICAL APPLICATION

### Low Noise Single-Ended Input to Differential Output Amplifier

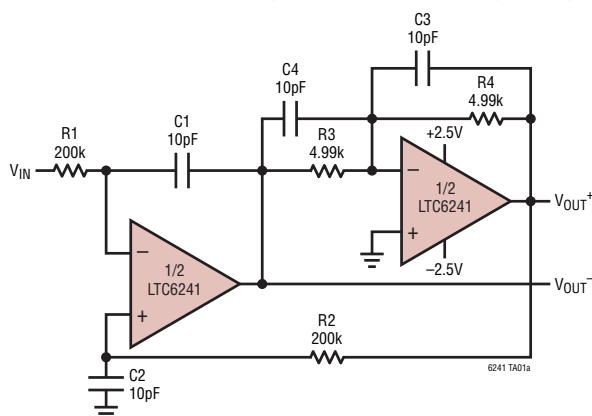

### Noise Voltage vs Frequency

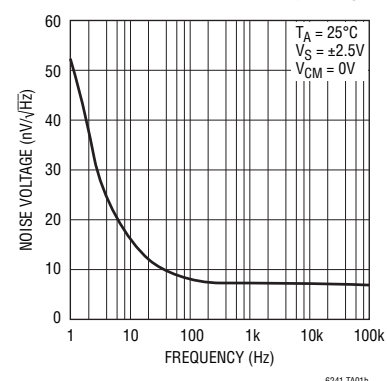

# LTC6240/LTC6241/LTC6242

## ABSOLUTE MAXIMUM RATINGS (Note 1)

Total Supply Voltage ( $V^+$ to $V^-$ )	
LTC6240/LTC6241/LTC6242 .....	7V
LTC6240HV/LTC6241HV/LTC6242HV .....	12V
Input Voltage.....	( $V^+ + 0.3V$ ) to ( $V^- - 0.3V$ )
Input Current.....	$\pm 10mA$
Output Short-Circuit Duration (Note 2) .....	Indefinite
Operating Temperature Range	
LTC6240C/LTC6241C/LTC6242C .....	$-40^\circ C$ to $85^\circ C$
LTC6240I/LTC6241I/LTC6242I .....	$-40^\circ C$ to $85^\circ C$
LTC6240H/LTC6241H/LTC6242H .....	$-40^\circ C$ to $125^\circ C$

Specified Temperature Range (Note 3)	
LTC6240C/LTC6241C/LTC6242C .....	$0^\circ C$ to $70^\circ C$
LTC6240I/LTC6241I/LTC6242I .....	$-40^\circ C$ to $85^\circ C$
LTC6240H/LTC6241H/LTC6242H .....	$-40^\circ C$ to $125^\circ C$
Junction Temperature .....	
DHC, DD Package .....	$150^\circ C$
DHC, DD Package .....	$125^\circ C$
Storage Temperature Range .....	
DHC, DD Package .....	$-65^\circ C$ to $150^\circ C$
DHC, DD Package .....	$-65^\circ C$ to $125^\circ C$
Lead Temperature (Soldering, 10 sec).....	
	$300^\circ C$

## PIN CONFIGURATION

<p>LTC6240</p> <p>TOP VIEW</p> <p>OUT 1 1, 5 <math>V^+</math> 5  <math>V^-</math> 2, 4 -IN 4      +IN 3 3</p> <p>S5 PACKAGE      5-LEAD PLASTIC TSOT-23  <math>T_{JMAX} = 150^\circ C, \theta_{JA} = 250^\circ C/W</math></p>	<p>LTC6240</p> <p>TOP VIEW</p> <p>NC 1, 8 NC 8      -IN 2, 7 <math>V^+</math> 7      +IN 3, 6 OUT 6  <math>V^-</math> 4, 5 NC 5</p> <p>S8 PACKAGE      8-LEAD PLASTIC SO  <math>T_{JMAX} = 150^\circ C, \theta_{JA} = 190^\circ C/W</math></p>
<p>LTC6241</p> <p>TOP VIEW</p> <p>OUT A 1, 8 <math>V^+</math> 8      -IN A 2, 7 OUT B 7      +IN A 3, 6 -IN B 6  <math>V^-</math> 4, 5 +IN B 5</p> <p>DD PACKAGE      8-LEAD (3mm x 3mm) PLASTIC DFN  <math>T_{JMAX} = 125^\circ C, \theta_{JA} = 43^\circ C/W</math>      UNDERSIDE METAL CONNECTED TO <math>V^-</math>      (PCB CONNECTION OPTIONAL)</p>	<p>LTC6241</p> <p>TOP VIEW</p> <p>OUT A 1, 8 <math>V^+</math> 8      -IN A 2, 7 OUT B 7      +IN A 3, 6 -IN B 6  <math>V^-</math> 4, 5 +IN B 5</p> <p>S8 PACKAGE      8-LEAD PLASTIC SO  <math>T_{JMAX} = 150^\circ C, \theta_{JA} = 190^\circ C/W</math></p>
<p>LTC6242</p> <p>TOP VIEW</p> <p>OUT A 1, 16 OUT D 16      -IN A 2, 15 -IN D 15      +IN A 3, 14 +IN D 14  <math>V^+</math> 4, 13 <math>V^-</math> 13      +IN B 5, 12 +IN C 12      -IN B 6, 11 -IN C 11      OUT B 7, 10 OUT C 10      NC 8, 9 NC 9</p> <p>DHC PACKAGE      16-LEAD (5mm x 3mm) PLASTIC DFN  <math>T_{JMAX} = 125^\circ C, \theta_{JA} = 43^\circ C/W</math>      UNDERSIDE METAL CONNECTED TO <math>V^-</math> (PCB CONNECTION OPTIONAL)</p>	<p>LTC6242</p> <p>TOP VIEW</p> <p>OUT A 1, 16 OUT D 16      -IN A 2, 15 -IN D 15      +IN A 3, 14 +IN D 14  <math>V^+</math> 4, 13 <math>V^-</math> 13      +IN B 5, 12 +IN C 12      -IN B 6, 11 -IN C 11      OUT B 7, 10 OUT C 10      NC 8, 9 NC 9</p> <p>GN PACKAGE      16-LEAD PLASTIC SSOP  <math>T_{JMAX} = 150^\circ C, \theta_{JA} = 135^\circ C/W</math></p>

## ORDER INFORMATION

LEAD FREE FINISH	TAPE AND REEL	PART MARKING*	PACKAGE DESCRIPTION	SPECIFIED TEMPERATURE RANGE
LTC6240CS5#PBF	LTC6240CS5#TRPBF	LTCRR	5-Lead Plastic TSOT-23	0°C to 70°C
LTC6240HVCS5#PBF	LTC6240HVCS5#TRPBF	LTCRS	5-Lead Plastic TSOT-23	0°C to 70°C
LTC6240IS5#PBF	LTC6240IS5#TRPBF	LTCRR	5-Lead Plastic TSOT-23	-40°C to 85°C
LTC6240HVIS5#PBF	LTC6240HVIS5#TRPBF	LTCRS	5-Lead Plastic TSOT-23	-40°C to 85°C
LTC6240HS5#PBF	LTC6240HS5#TRPBF	LTCRR	5-Lead Plastic TSOT-23	-40°C to 125°C
LTC6240HVHS5#PBF	LTC6240HVHS5#TRPBF	LTCRS	5-Lead Plastic TSOT-23	-40°C to 125°C
LTC6240CS8#PBF	LTC6240CS8#TRPBF	6240	8-Lead Plastic SO	0°C to 70°C
LTC6240HVCS8#PBF	LTC6240HVCS8#TRPBF	6240HV	8-Lead Plastic SO	0°C to 70°C
LTC6240IS8#PBF	LTC6240IS8#TRPBF	6240I	8-Lead Plastic SO	-40°C to 85°C
LTC6240HVIS8#PBF	LTC6240HVIS8#TRPBF	240HVI	8-Lead Plastic SO	-40°C to 85°C
LTC6240HS8#PBF	LTC6240HS8#TRPBF	6240H	8-Lead Plastic SO	-40°C to 125°C
LTC6240HVHS8#PBF	LTC6240HVHS8#TRPBF	240HVH	8-Lead Plastic SO	-40°C to 125°C
LTC6241CDD#PBF	LTC6241CDD#TRPBF	LBPD	8-Lead (3mm × 3mm) Plastic DFN	0°C to 70°C
LTC6241HVCDD#PBF	LTC6241HVCDD#TRPBF	LBRR	8-Lead (3mm × 3mm) Plastic DFN	0°C to 70°C
LTC6241IDD#PBF	LTC6241IDD#TRPBF	LBPD	8-Lead (3mm × 3mm) Plastic DFN	-40°C to 85°C
LTC6241HVIDD#PBF	LTC6241HVIDD#TRPBF	LBRR	8-Lead (3mm × 3mm) Plastic DFN	-40°C to 85°C
LTC6241CS8#PBF	LTC6241CS8#TRPBF	6241	8-Lead Plastic SO	0°C to 70°C
LTC6241HVCS8#PBF	LTC6241HVCS8#TRPBF	6241HV	8-Lead Plastic SO	0°C to 70°C
LTC6241IS8#PBF	LTC6241IS8#TRPBF	6241I	8-Lead Plastic SO	-40°C to 85°C
LTC6241HVIS8#PBF	LTC6241HVIS8#TRPBF	241HVI	8-Lead Plastic SO	-40°C to 85°C
LTC6241HS8#PBF	LTC6241HS8#TRPBF	6241H	8-Lead Plastic SO	-40°C to 125°C
LTC6241HVHS8#PBF	LTC6241HVHS8#TRPBF	241HVH	8-Lead Plastic SO	-40°C to 125°C
LTC6242CDHC#PBF	LTC6242CDHC#TRPBF	6242	16-Lead (5mm × 3mm) Plastic DFN	0°C to 70°C
LTC6242HVCDHC#PBF	LTC6242HVCDHC#TRPBF	6242HV	16-Lead (5mm × 3mm) Plastic DFN	0°C to 70°C
LTC6242IDHC#PBF	LTC6242IDHC#TRPBF	6242	16-Lead (5mm × 3mm) Plastic DFN	-40°C to 85°C
LTC6242HVIDHC#PBF	LTC6242HVIDHC#TRPBF	6242HV	16-Lead (5mm × 3mm) Plastic DFN	-40°C to 85°C
LTC6242CGN#PBF	LTC6242CGN#TRPBF	6242	16-Lead Plastic SSOP	0°C to 70°C
LTC6242HVCGN#PBF	LTC6242HVCGN#TRPBF	6242HV	16-Lead Plastic SSOP	0°C to 70°C
LTC6242IGN#PBF	LTC6242IGN#TRPBF	6242I	16-Lead Plastic SSOP	-40°C to 85°C
LTC6242HVIGN#PBF	LTC6242HVIGN#TRPBF	242HVI	16-Lead Plastic SSOP	-40°C to 85°C
LTC6242HGN#PBF	LTC6242HGN#TRPBF	6242H	16-Lead Plastic SSOP	-40°C to 125°C
LTC6242HVHGN#PBF	LTC6242HVHGN#TRPBF	242HVH	16-Lead Plastic SSOP	-40°C to 125°C

Consult LTC Marketing for parts specified with wider operating temperature ranges. \*The temperature grade is identified by a label on the shipping container. Consult LTC Marketing for information on non-standard lead based finish parts.

For more information on lead free part marking, go to: <http://www.linear.com/leadfree/>

For more information on tape and reel specifications, go to: <http://www.linear.com/tapeandree/>

# LTC6240/LTC6241/LTC6242

## AVAILABLE OPTIONS

PART NUMBER	AMPS/PACKAGE	SPECIFIED TEMP RANGE	SPECIFIED SUPPLY VOLTAGE	PACKAGE	PART MARKING
LTC6240CS5	1	0°C to 70°C	3V, 5V	SOT-23	LTCRR
LTC6240CS8	1	0°C to 70°C	3V, 5V	SO-8	6240
LTC6240HVCS5	1	0°C to 70°C	3V, 5V, ±5V	SOT-23	LTCRS
LTC6240HVCS8	1	0°C to 70°C	3V, 5V, ±5V	SO-8	6240HV
LTC6240IS5	1	-40°C to 85°C	3V, 5V	SOT-23	LTCRR
LTC6240IS8	1	-40°C to 85°C	3V, 5V	SO-8	6240I
LTC6240HVIS5	1	-40°C to 85°C	3V, 5V, ±5V	SOT-23	LTCRS
LTC6240HVIS8	1	-40°C to 85°C	3V, 5V, ±5V	SO-8	240HVI
LTC6240HS5	1	-40°C to 125°C	3V, 5V	SOT-23	LTCRR
LTC6240HS8	1	-40°C to 125°C	3V, 5V	SO-8	6240H
LTC6240HVHS5	1	-40°C to 125°C	3V, 5V, ±5V	SOT-23	LTCRS
LTC6240HVHS8	1	-40°C to 125°C	3V, 5V, ±5V	SO-8	240HVH
LTC6241CS8	2	0°C to 70°C	3V, 5V	SO-8	6241
LTC6241CDD	2	0°C to 70°C	3V, 5V	DD	LBDP
LTC6241HVCS8	2	0°C to 70°C	3V, 5V, ±5V	SO-8	6241HV
LTC6241HVCDD	2	0°C to 70°C	3V, 5V, ±5V	DD	LBRR
LTC6241IS8	2	-40°C to 85°C	3V, 5V	SO-8	6241I
LTC6241IDD	2	-40°C to 85°C	3V, 5V	DD	LBDP
LTC6241HVIS8	2	-40°C to 85°C	3V, 5V, ±5V	SO-8	241HVI
LTC6241HVIDD	2	-40°C to 85°C	3V, 5V, ±5V	DD	LBRR
LTC6241HS8	2	-40°C to 125°C	3V, 5V	SO-8	6241H
LTC6241HVHS8	2	-40°C to 125°C	3V, 5V, ±5V	SO-8	241HVH
LTC6242CGN	4	0°C to 70°C	3V, 5V	GN	6242
LTC6242CDHC	4	0°C to 70°C	3V, 5V	DHC	6242
LTC6242HVCGN	4	0°C to 70°C	3V, 5V, ±5V	GN	6242HV
LTC6242HVCDHC	4	0°C to 70°C	3V, 5V, ±5V	DHC	6242HV
LTC6242IGN	4	-40°C to 85°C	3V, 5V	GN	6242I
LTC6242IDHC	4	-40°C to 85°C	3V, 5V	DHC	6242
LTC6242HVIGN	4	-40°C to 85°C	3V, 5V, ±5V	GN	242HVI
LTC6242HVIDHC	4	-40°C to 85°C	3V, 5V, ±5V	DHC	6242HV
LTC6242HGN	4	-40°C to 125°C	3V, 5V	GN	6242H
LTC6242HVHGN	4	-40°C to 125°C	3V, 5V, ±5V	GN	242HVH

**ELECTRICAL CHARACTERISTICS** (LTC6240C/I, LTC6240HVC/I, LTC6241C/I, LTC6241HVC/I, LTC6242C/I, LTC6242HVC/I) The ● denotes the specifications which apply over the full operating temperature range, otherwise specifications are at  $T_A = 25^\circ\text{C}$ .  $V_S = 5\text{V}$ ,  $0\text{V}$ ,  $V_{CM} = 2.5\text{V}$  unless otherwise noted.

SYMBOL	PARAMETER	CONDITIONS	MIN	TYP	MAX	UNITS
$V_{OS}$	Input Offset Voltage (Note 4)	LTC6241 S8 0°C to 70°C -40°C to 85°C	●	40	125 250 300	$\mu\text{V}$ $\mu\text{V}$ $\mu\text{V}$
		LTC6242 GN 0°C to 70°C -40°C to 85°C	●	50	150 275 300	$\mu\text{V}$ $\mu\text{V}$ $\mu\text{V}$
		LTC6240 0°C to 70°C -40°C to 85°C	●	50	175 300 350	$\mu\text{V}$ $\mu\text{V}$ $\mu\text{V}$
		LTC6241 DD, LTC6242 DHC 0°C to 70°C -40°C to 85°C	●	100	550 650 725	$\mu\text{V}$ $\mu\text{V}$ $\mu\text{V}$
	$V_{OS}$ Match Channel-to-Channel (Note 5)	LTC6241 S8 0°C to 70°C -40°C to 85°C	●	40	160 300 375	$\mu\text{V}$ $\mu\text{V}$ $\mu\text{V}$
		LTC6242 GN 0°C to 70°C -40°C to 85°C	●	50	185 325 400	$\mu\text{V}$ $\mu\text{V}$ $\mu\text{V}$
LTC6241 DD, LTC6242 DHC 0°C to 70°C -40°C to 85°C		●	150	650 700 750	$\mu\text{V}$ $\mu\text{V}$ $\mu\text{V}$	
$TC V_{OS}$	Input Offset Voltage Drift (Note 6)		●	0.7	2.5	$\mu\text{V}/^\circ\text{C}$
$I_B$	Input Bias Current (Notes 4, 7)	LTC6241, LTC6242	●	0.2	75	$\text{pA}$ $\text{pA}$
		LTC6240	●	0.2	1 75	$\text{pA}$ $\text{pA}$
$I_{OS}$	Input Offset Current (Notes 4, 7)	LTC6241, LTC6242	●	0.2	75	$\text{pA}$ $\text{pA}$
		LTC6240	●	0.2	1 75	$\text{pA}$ $\text{pA}$
	Input Noise Voltage	0.1Hz to 10Hz		550		$\text{nV}_{\text{P-P}}$
$e_n$	Input Noise Voltage Density	$f = 1\text{kHz}$		7	10	$\text{nV}/\sqrt{\text{Hz}}$
$i_n$	Input Noise Current Density (Note 8)			0.56		$\text{fA}/\sqrt{\text{Hz}}$
$R_{IN}$	Input Resistance	Common Mode		$10^{12}$		$\Omega$
$C_{IN}$	Input Capacitance Differential Mode Common Mode	$f = 100\text{kHz}$		3.5		$\text{pF}$
				3		$\text{pF}$
$V_{CM}$	Input Voltage Range	Guaranteed by CMRR	●	0	3.5	V
CMRR	Common Mode Rejection	$0\text{V} \leq V_{CM} \leq 3.5\text{V}$	●	80	105	dB
	CMRR Match Channel-to-Channel (Note 5)		●	76	95	dB

# LTC6240/LTC6241/LTC6242

**ELECTRICAL CHARACTERISTICS** (LTC6240C/I, LTC6240HVC/I, LTC6241C/I, LTC6241HVC/I, LTC6242C/I, LTC6242HVC/I) The ● denotes the specifications which apply over the full operating temperature range, otherwise specifications are at  $T_A = 25^\circ\text{C}$ .  $V_S = 5\text{V}$ ,  $0\text{V}$ ,  $V_{\text{CM}} = 2.5\text{V}$  unless otherwise noted.

SYMBOL	PARAMETER	CONDITIONS	MIN	TYP	MAX	UNITS	
$A_{\text{VOL}}$	Large Signal Voltage Gain	$V_O = 1\text{V to }4\text{V}$ $R_L = 10\text{k to }V_S/2$ $0^\circ\text{C to }70^\circ\text{C}$ $-40^\circ\text{C to }85^\circ\text{C}$	● ●	425 300	1600	V/mV V/mV V/mV	
		$V_O = 1.5\text{V to }3.5\text{V}$ $R_L = 1\text{k to }V_S/2$ $0^\circ\text{C to }70^\circ\text{C}$ $-40^\circ\text{C to }85^\circ\text{C}$	● ●	90 60 50	215	V/mV V/mV V/mV	
$V_{\text{OL}}$	Output Voltage Swing Low (Note 9)	No Load	●	7	30	mV	
		$I_{\text{SINK}} = 1\text{mA}$	●	40	75	mV	
		$I_{\text{SINK}} = 5\text{mA}$	●	190	325	mV	
$V_{\text{OH}}$	Output Voltage Swing High (Note 9)	No Load	●	11	30	mV	
		$I_{\text{SOURCE}} = 1\text{mA}$	●	45	75	mV	
		$I_{\text{SOURCE}} = 5\text{mA}$	●	190	325	mV	
PSRR	Power Supply Rejection	$V_S = 2.8\text{V to }6\text{V}$ , $V_{\text{CM}} = 0.2\text{V}$	●	80	104	dB	
	PSRR Match Channel-to-Channel (Note 5)		●	74	100	dB	
	Minimum Supply Voltage (Note 10)		●	2.8		V	
$I_{\text{SC}}$	Short-Circuit Current		●	15	30	mA	
$I_S$	Supply Current per Amplifier	LTC6241, LTC6242 $0^\circ\text{C to }70^\circ\text{C}$ $-40^\circ\text{C to }85^\circ\text{C}$	● ●	1.8	2.2 2.3 2.4	mA mA mA	
		LTC6240 $0^\circ\text{C to }70^\circ\text{C}$ $-40^\circ\text{C to }85^\circ\text{C}$	● ●	2	2.4 2.5 2.6	mA mA mA	
GBW	Gain Bandwidth Product	Frequency = 20kHz, $R_L = 1\text{k}\Omega$	●	13	18	MHz	
SR	Slew Rate (Note 11)	$A_V = -2$ , $R_L = 1\text{k}\Omega$	●	5	10	V/ $\mu\text{s}$	
FPBW	Full Power Bandwidth (Note 12)	$V_{\text{OUT}} = 3V_{\text{P-P}}$ , $R_L = 1\text{k}\Omega$	●	0.53	1.06	MHz	
$t_s$	Settling Time	$V_{\text{STEP}} = 2\text{V}$ , $A_V = -1$ , $R_L = 1\text{k}\Omega$ , 0.1%		1100		ns	

**ELECTRICAL CHARACTERISTICS** (LTC6240C/I, LTC6240HVC/I, LTC6241C/I, LTC6241HVC/I, LTC6242C/I, LTC6242HVC/I) The ● denotes the specifications which apply over the full operating temperature range, otherwise specifications are at  $T_A = 25^\circ\text{C}$ .  $V_S = 3\text{V}$ ,  $0\text{V}$ ,  $V_{CM} = 1.5\text{V}$  unless otherwise noted.

SYMBOL	PARAMETER	CONDITIONS	MIN	TYP	MAX	UNITS
$V_{OS}$	Input Offset Voltage (Note 4)	LTC6241 S8 0°C to 70°C -40°C to 85°C	● ●	40	175 275 325	$\mu\text{V}$ $\mu\text{V}$ $\mu\text{V}$
		LTC6242 GN 0°C to 70°C -40°C to 85°C	● ●	60	200 275 325	$\mu\text{V}$ $\mu\text{V}$ $\mu\text{V}$
		LTC6240 0°C to 70°C -40°C to 85°C	● ●	50	200 325 375	$\mu\text{V}$ $\mu\text{V}$ $\mu\text{V}$
		LTC6241 DD, LTC6242 DHC 0°C to 70°C -40°C to 85°C	● ●	100	550 650 725	$\mu\text{V}$ $\mu\text{V}$ $\mu\text{V}$
	$V_{OS}$ Match Channel-to-Channel (Note 5)	LTC6241 S8 0°C to 70°C -40°C to 85°C	● ●	40	200 325 400	$\mu\text{V}$ $\mu\text{V}$ $\mu\text{V}$
		LTC6242 GN 0°C to 70°C -40°C to 85°C	● ●	60	225 325 400	$\mu\text{V}$ $\mu\text{V}$ $\mu\text{V}$
LTC6241 DD, LTC6242 DHC 0°C to 70°C -40°C to 85°C		● ●	150	650 700 750	$\mu\text{V}$ $\mu\text{V}$ $\mu\text{V}$	
$TC V_{OS}$	Input Offset Voltage Drift (Note 6)		●	0.7	2.5	$\mu\text{V}/^\circ\text{C}$
$I_B$	Input Bias Current (Notes 4, 7)	LTC6241, LTC6242	●	0.2	75	pA pA
		LTC6240	●	0.2	1 75	pA pA
$I_{OS}$	Input Offset Current (Notes 4, 7)	LTC6241, LTC6242	●	0.2	75	pA pA
		LTC6240	●	0.2	1 75	pA pA
$V_{CM}$	Input Voltage Range	Guaranteed by CMRR	●	0	1.5	V
CMRR	Common Mode Rejection	$0\text{V} \leq V_{CM} \leq 1.5\text{V}$	●	78	100	dB
	CMRR Match Channel-to-Channel (Note 5)		●	76	95	dB
$A_{VOL}$	Large Signal Voltage Gain	$V_O = 1\text{V to } 2\text{V}$ $R_L = 10\text{k to } V_S/2$ 0°C to 70°C -40°C to 85°C	● ●	140 100 75	600	V/mV V/mV V/mV
$V_{OL}$	Output Voltage Swing Low (Note 9)	No Load $I_{SINK} = 1\text{mA}$	● ●	3 65	30 110	mV mV
$V_{OH}$	Output Voltage Swing High (Note 9)	No Load $I_{SOURCE} = 1\text{mA}$	● ●	4 70	30 120	mV mV
PSRR	Power Supply Rejection	$V_S = 2.8\text{V to } 6\text{V}$ , $V_{CM} = 0.2\text{V}$	●	80	104	dB
	PSRR Match Channel-to-Channel (Note 5)		●	74	100	dB
	Minimum Supply Voltage (Note 10)		●	2.8		V
$I_{SC}$	Short-Circuit Current		●	3	6	mA

# LTC6240/LTC6241/LTC6242

**ELECTRICAL CHARACTERISTICS** (LTC6240C/I, LTC6240HVC/I, LTC6241C/I, LTC6241HVC/I, LTC6242C/I, LTC6242HVC/I) The ● denotes the specifications which apply over the full operating temperature range, otherwise specifications are at  $T_A = 25^\circ\text{C}$ .  $V_S = 3\text{V}$ ,  $0\text{V}$ ,  $V_{CM} = 1.5\text{V}$  unless otherwise noted.

SYMBOL	PARAMETER	CONDITIONS	MIN	TYP	MAX	UNITS
$I_S$	Supply Current per Amplifier	LTC6241, LTC6242 0°C to 70°C -40°C to 85°C	●	1.4	1.7	mA
			●		1.8	mA
		LTC6240 0°C to 70°C -40°C to 85°C	●	1.5	1.9	mA
			●		2	mA
			●		2.1	mA
GBW	Gain Bandwidth Product	Frequency = 20kHz, $R_L = 1\text{k}\Omega$	●	12	17	MHz

(LTC6240HVC/I, LTC6241HVC/I, LTC6242HVC/I) The ● denotes the specifications which apply over the full operating temperature range, otherwise specifications are at  $T_A = 25^\circ\text{C}$ .  $V_S = \pm 5\text{V}$ ,  $0\text{V}$ ,  $V_{CM} = 0\text{V}$  unless otherwise noted.

SYMBOL	PARAMETER	CONDITIONS	MIN	TYP	MAX	UNITS
$V_{OS}$	Input Offset Voltage (Note 4)	LTC6241 S8 0°C to 70°C -40°C to 85°C	●	50	175	$\mu\text{V}$
			●		275	$\mu\text{V}$
			●		325	$\mu\text{V}$
			●		325	$\mu\text{V}$
		LTC6242 GN 0°C to 70°C -40°C to 85°C	●	60	200	$\mu\text{V}$
			●		275	$\mu\text{V}$
			●		325	$\mu\text{V}$
			●		400	$\mu\text{V}$
	$V_{OS}$ Match Channel-to-Channel (Note 5)	LTC6241 DD, LTC6242 DHC 0°C to 70°C -40°C to 85°C	●	100	550	$\mu\text{V}$
		●		650	$\mu\text{V}$	
		●		725	$\mu\text{V}$	
		●		725	$\mu\text{V}$	
	LTC6241 S8 0°C to 70°C -40°C to 85°C	●	50	200	$\mu\text{V}$	
		●		325	$\mu\text{V}$	
		●		400	$\mu\text{V}$	
	LTC6242 GN 0°C to 70°C -40°C to 85°C	●	60	225	$\mu\text{V}$	
		●		325	$\mu\text{V}$	
		●		400	$\mu\text{V}$	
	LTC6241 DD, LTC6242 DHC 0°C to 70°C -40°C to 85°C	●	150	650	$\mu\text{V}$	
		●		700	$\mu\text{V}$	
		●		750	$\mu\text{V}$	
TC $V_{OS}$	Input Offset Voltage Drift (Note 6)		●	0.7	2.5	$\mu\text{V}/^\circ\text{C}$
$I_B$	Input Bias Current (Notes 4, 7)	LTC6241, LTC6242	●	0.5	75	pA
		LTC6240	●	0.5	1	pA
			●		75	pA
$I_{OS}$	Input Offset Current (Notes 4, 7)	LTC6241, LTC6242	●	0.2	75	pA
			●		75	pA
		LTC6240	●	0.2	1	pA
			●		75	pA
	Input Noise Voltage	0.1Hz to 10Hz		550		nV <sub>P-P</sub>

## ELECTRICAL CHARACTERISTICS

(LTC6240HVC/I, LTC6241HVC/I, LTC6242HVC/I) The ● denotes the specifications which apply over the full operating temperature range, otherwise specifications are at  $T_A = 25^\circ\text{C}$ .  $V_S = \pm 5\text{V}$ ,  $0\text{V}$ ,  $V_{\text{CM}} = 0\text{V}$  unless otherwise noted.

SYMBOL	PARAMETER	CONDITIONS	MIN	TYP	MAX	UNITS
$e_n$	Input Noise Voltage Density	$f = 1\text{kHz}$		7	10	$\text{nV}/\sqrt{\text{Hz}}$
$i_n$	Input Noise Current Density (Note 8)			0.56		$\text{fA}/\sqrt{\text{Hz}}$
$R_{\text{IN}}$	Input Resistance	Common Mode		$10^{12}$		$\Omega$
$C_{\text{IN}}$	Input Capacitance Differential Mode Common Mode	$f = 100\text{kHz}$		3.5 3		pF pF
$V_{\text{CM}}$	Input Voltage Range	Guaranteed by CMRR	●	-5	3.5	V
CMRR	Common Mode Rejection	$-5\text{V} \leq V_{\text{CM}} \leq 3.5\text{V}$	●	83	105	dB
	CMRR Match Channel-to-Channel (Note 5)		●	76	95	dB
$A_{\text{VOL}}$	Large Signal Voltage Gain	$V_0 = -3.5\text{V to } 3.5\text{V}$ $R_L = 10\text{k}$ $0^\circ\text{C to } 70^\circ\text{C}$ $-40^\circ\text{C to } 85^\circ\text{C}$	● ●	775 600 500	2700	V/mV V/mV V/mV
		$R_L = 1\text{k}$ $0^\circ\text{C to } 70^\circ\text{C}$ $-40^\circ\text{C to } 85^\circ\text{C}$	● ●	150 90 75	360	V/mV V/mV V/mV
$V_{\text{OL}}$	Output Voltage Swing Low (Note 9)	No Load $I_{\text{SINK}} = 1\text{mA}$ $I_{\text{SINK}} = 10\text{mA}$	● ● ●	15 45 360	30 75 550	mV mV mV
$V_{\text{OH}}$	Output Voltage Swing High (Note 9)	No Load $I_{\text{SOURCE}} = 1\text{mA}$ $I_{\text{SOURCE}} = 10\text{mA}$	● ● ●	15 45 360	30 75 550	mV mV mV
PSRR	Power Supply Rejection	$V_S = 2.8\text{V to } 11\text{V}$ , $V_{\text{CM}} = 0.2\text{V}$	●	85	110	dB
	PSRR Match Channel-to-Channel (Note 5)		●	82	106	dB
	Minimum Supply Voltage (Note 10)		●	2.8		V
$I_{\text{SC}}$	Short-Circuit Current		●	15	35	mA
$I_S$	Supply Current per Amplifier	LTC6241, LTC6242 $0^\circ\text{C to } 70^\circ\text{C}$ $-40^\circ\text{C to } 85^\circ\text{C}$	● ●	2.5	3.2 3.3 3.7	mA mA mA
		LTC6240 $0^\circ\text{C to } 70^\circ\text{C}$ $-40^\circ\text{C to } 85^\circ\text{C}$	● ●	2.7	3.3 3.4 3.8	mA mA mA
GBW	Gain Bandwidth Product	Frequency = $20\text{kHz}$ , $R_L = 1\text{k}\Omega$	●	13	18	MHz
SR	Slew Rate (Note 11)	$A_V = -2$ , $R_L = 1\text{k}\Omega$	●	5.5	10	$\text{V}/\mu\text{s}$
FPBW	Full Power Bandwidth (Note 12)	$V_{\text{OUT}} = 3V_{\text{P-P}}$ , $R_L = 1\text{k}\Omega$	●	0.58	1.06	MHz
$t_s$	Settling Time	$V_{\text{STEP}} = 2\text{V}$ , $A_V = -1$ , $R_L = 1\text{k}\Omega$ , 0.1%		900		ns

# LTC6240/LTC6241/LTC6242

## ELECTRICAL CHARACTERISTICS (LTC6240H/LTC6240HVH, LTC6241H/LTC6241HVH, LTC6242H/LTC6242HVH)

The ● denotes the specifications which apply from  $-40^{\circ}\text{C}$  to  $125^{\circ}\text{C}$ , otherwise specifications are at  $T_A = 25^{\circ}\text{C}$ .  $V_S = 5\text{V}$ ,  $0\text{V}$ ,  $V_{\text{CM}} = 2.5\text{V}$  unless otherwise noted.

SYMBOL	PARAMETER	CONDITIONS	MIN	TYP	MAX	UNITS
$V_{\text{OS}}$	Input Offset Voltage (Note 4)	LTC6241 S8	●	40	125 400	$\mu\text{V}$ $\mu\text{V}$
		LTC6242 GN	●	50	150 400	$\mu\text{V}$ $\mu\text{V}$
		LTC6240	●	50	175 450	$\mu\text{V}$ $\mu\text{V}$
	$V_{\text{OS}}$ Match Channel-to-Channel (Note 5)	LTC6241 S8	●	40	160 400	$\mu\text{V}$ $\mu\text{V}$
		LTC6242 GN	●	50	185 400	$\mu\text{V}$ $\mu\text{V}$
	TC $V_{\text{OS}}$	Input Offset Voltage Drift (Note 6)		●	0.7	2.5
$I_{\text{B}}$	Input Bias Current (Notes 4, 7)	LTC6241, LTC6242	●	0.2	1.5	$\text{pA}$ $\text{nA}$
		LTC6240	●	0.2	1 2.5	$\text{pA}$ $\text{nA}$
$I_{\text{OS}}$	Input Offset Current (Notes 4, 7)	LTC6241, LTC6242	●	0.2	150	$\text{pA}$ $\text{pA}$
		LTC6240	●	0.2	1 750	$\text{pA}$ $\text{pA}$
$V_{\text{CM}}$	Input Voltage Range	Guaranteed by CMRR	●	0	3.5	V
CMRR	Common Mode Rejection	$0\text{V} \leq V_{\text{CM}} \leq 3.5\text{V}$	●	78		dB
	CMRR Match Channel-to-Channel (Note 5)		●	74		dB
$A_{\text{VOL}}$	Large Signal Voltage Gain	$V_{\text{O}} = 1\text{V to }4\text{V}$ $R_{\text{L}} = 10\text{k to }V_{\text{S}}/2$	●	425 200	1600	$\text{V/mV}$ $\text{V/mV}$
		$V_{\text{O}} = 1.5\text{V to }3.5\text{V}$ $R_{\text{L}} = 1\text{k to }V_{\text{S}}/2$	●	90 40	215	$\text{V/mV}$ $\text{V/mV}$
$V_{\text{OL}}$	Output Voltage Swing Low (Note 9)	No Load	●		30	mV
		$I_{\text{SINK}} = 1\text{mA}$	●		85	mV
		$I_{\text{SINK}} = 5\text{mA}$	●		325	mV
$V_{\text{OH}}$	Output Voltage Swing High (Note 9)	No Load	●		30	mV
		$I_{\text{SOURCE}} = 1\text{mA}$	●		85	mV
		$I_{\text{SOURCE}} = 5\text{mA}$	●		325	mV
PSRR	Power Supply Rejection	$V_{\text{S}} = 2.8\text{V to }6\text{V}$ , $V_{\text{CM}} = 0.2\text{V}$	●	78		dB
	PSRR Match Channel-to-Channel (Note 5)		●	74		dB
	Minimum Supply Voltage (Note 10)		●	2.8		V
$I_{\text{SC}}$	Short-Circuit Current		●	15		mA
$I_{\text{S}}$	Supply Current per Amplifier	LTC6241, LTC6242	●	1.8	2.2 2.4	mA mA
		LTC6240	●	2	2.4 2.8	mA mA
GBW	Gain Bandwidth Product	Frequency = 20kHz, $R_{\text{L}} = 1\text{k}\Omega$	●	12		MHz
SR	Slew Rate (Note 11)	$A_{\text{V}} = -2$ , $R_{\text{L}} = 1\text{k}\Omega$	●	4.5		$\text{V}/\mu\text{s}$
FPBW	Full Power Bandwidth (Note 12)	$V_{\text{OUT}} = 3V_{\text{P-P}}$ , $R_{\text{L}} = 1\text{k}\Omega$	●	0.48		MHz

**ELECTRICAL CHARACTERISTICS** (LTC6240H/LTC6240HVH, LTC6241H/LTC6241HVH, LTC6242H/LTC6242HVH)

The ● denotes the specifications which apply from  $-40^{\circ}\text{C}$  to  $125^{\circ}\text{C}$ , otherwise specifications are at  $T_A = 25^{\circ}\text{C}$ .  $V_S = 3\text{V}$ ,  $0\text{V}$ ,  $V_{\text{CM}} = 1.5\text{V}$  unless otherwise noted.

SYMBOL	PARAMETER	CONDITIONS	MIN	TYP	MAX	UNITS
$V_{\text{OS}}$	Input Offset Voltage (Note 4)	LTC6241 S8	●	40	175 400	$\mu\text{V}$ $\mu\text{V}$
		LTC6242 GN	●	60	200 400	$\mu\text{V}$ $\mu\text{V}$
		LTC6240	●	50	200 450	$\mu\text{V}$ $\mu\text{V}$
	$V_{\text{OS}}$ Match Channel-to-Channel (Note 5)	LTC6241 S8	●	40	200 400	$\mu\text{V}$ $\mu\text{V}$
		LTC6242 GN	●	60	225 400	$\mu\text{V}$ $\mu\text{V}$
	TC $V_{\text{OS}}$	Input Offset Voltage Drift (Note 6)		●	0.7	2.5
$I_{\text{B}}$	Input Bias Current (Notes 4, 7)	LTC6241, LTC6242	●	0.2	1.5	$\text{pA}$ $\text{nA}$
		LTC6240	●	0.2	1 2.5	$\text{pA}$ $\text{nA}$
$I_{\text{OS}}$	Input Offset Current (Notes 4, 7)	LTC6241, LTC6242	●	0.2	150	$\text{pA}$ $\text{pA}$
		LTC6240	●	0.2	1 750	$\text{pA}$ $\text{pA}$
$V_{\text{CM}}$	Input Voltage Range	Guaranteed by CMRR	●	0	1.5	V
CMRR	Common Mode Rejection	$0\text{V} \leq V_{\text{CM}} \leq 1.5\text{V}$	●	75		dB
	CMRR Match Channel-to-Channel (Note 5)		●	74		dB
$A_{\text{VOL}}$	Large Signal Voltage Gain	$V_{\text{O}} = 1\text{V to } 2\text{V}$ $R_{\text{L}} = 10\text{k to } V_{\text{S}}/2$	●	140 65	600	$\text{V/mV}$ $\text{V/mV}$
$V_{\text{OL}}$	Output Voltage Swing Low (Note 9)	No Load $I_{\text{SINK}} = 1\text{mA}$	● ●		30 130	$\text{mV}$ $\text{mV}$
$V_{\text{OH}}$	Output Voltage Swing High (Note 9)	No Load $I_{\text{SOURCE}} = 1\text{mA}$	● ●		30 130	$\text{mV}$ $\text{mV}$
PSRR	Power Supply Rejection	$V_{\text{S}} = 2.8\text{V to } 6\text{V}$ , $V_{\text{CM}} = 0.2\text{V}$	●	78		dB
	PSRR Match Channel-to-Channel (Note 5)		●	74		dB
	Minimum Supply Voltage (Note 10)		●	2.8		V
$I_{\text{SC}}$	Short-Circuit Current		●	2.5		mA
$I_{\text{S}}$	Supply Current per Amplifier	LTC6241, LTC6242	●	1.4	1.7 1.9	mA mA
		LTC6240	●	1.5	1.9 2.1	mA mA
GBW	Gain Bandwidth Product	Frequency = 20kHz, $R_{\text{L}} = 1\text{k}\Omega$	●	10		MHz

# LTC6240/LTC6241/LTC6242

## ELECTRICAL CHARACTERISTICS (LTC6240HVH/LTC6241HVH/LTC6242HVH) The ● denotes the specifications which apply from $-40^{\circ}\text{C}$ to $125^{\circ}\text{C}$ , otherwise specifications are at $T_A = 25^{\circ}\text{C}$ . $V_S = \pm 5\text{V}$ , $V_{CM} = 0\text{V}$ unless otherwise noted.

SYMBOL	PARAMETER	CONDITIONS	MIN	TYP	MAX	UNITS
$V_{OS}$	Input Offset Voltage (Note 4)	LTC6241 S8	●	50	175 400	$\mu\text{V}$ $\mu\text{V}$
		LTC6242 GN	●	60	200 400	$\mu\text{V}$ $\mu\text{V}$
		LTC6240	●	60	250 450	$\mu\text{V}$ $\mu\text{V}$
	$V_{OS}$ Match Channel-to-Channel (Note 5)	LTC6241 S8	●	50	200 400	$\mu\text{V}$ $\mu\text{V}$
		LTC6242 GN	●	60	225 400	$\mu\text{V}$ $\mu\text{V}$
	$TC V_{OS}$	Input Offset Voltage Drift (Note 6)		●	0.7	2.5
$I_B$	Input Bias Current (Notes 4, 7)	LTC6241, LTC6242	●	0.5	1.5	$\text{pA}$ $\text{nA}$
		LTC6240	●	0.5	1 2.5	$\text{pA}$ $\text{nA}$
$I_{OS}$	Input Offset Current (Notes 4, 7)	LTC6241, LTC6242	●	0.2	150	$\text{pA}$ $\text{pA}$
		LTC6240	●	0.2	1 750	$\text{pA}$ $\text{pA}$
$V_{CM}$	Input Voltage Range	Guaranteed by CMRR	●	-5	3.5	V
CMRR	Common Mode Rejection	$-5\text{V} \leq V_{CM} \leq 3.5\text{V}$	●	80		dB
	CMRR Match Channel-to-Channel (Note 5)		●	76		dB
$A_{VOL}$	Large Signal Voltage Gain	$V_O = -3.5\text{V}$ to $3.5\text{V}$ $R_L = 10\text{k}$	●	775 350	2700	$\text{V}/\text{mV}$ $\text{V}/\text{mV}$
		$R_L = 1\text{k}$	●	150 60	360	$\text{V}/\text{mV}$ $\text{V}/\text{mV}$
$V_{OL}$	Output Voltage Swing Low (Note 9)	No Load	●		30	mV
		$I_{SINK} = 1\text{mA}$	●		85	mV
		$I_{SINK} = 10\text{mA}$	●		600	mV
$V_{OH}$	Output Voltage Swing High (Note 9)	No Load	●		30	mV
		$I_{SOURCE} = 1\text{mA}$	●		85	mV
		$I_{SOURCE} = 10\text{mA}$	●		600	mV
PSRR	Power Supply Rejection	$V_S = 2.8\text{V}$ to $11\text{V}$ , $V_{CM} = 0.2\text{V}$	●	83		dB
	PSRR Match Channel-to-Channel (Note 5)		●	82		dB
	Minimum Supply Voltage (Note 10)		●	2.8		V
$I_{SC}$	Short-Circuit Current		●	15		mA
$I_S$	Supply Current per Amplifier	LTC6241, LTC6242	●	2.5	3.2 3.7	mA mA
		LTC6240	●	2.7	3.3 3.8	mA mA
GBW	Gain Bandwidth Product	Frequency = $20\text{kHz}$ , $R_L = 1\text{k}\Omega$	●	12		MHz
SR	Slew Rate (Note 11)	$A_V = -2$ , $R_L = 1\text{k}\Omega$	●	5		$\text{V}/\mu\text{s}$
FPBW	Full Power Bandwidth (Note 12)	$V_{OUT} = 3\text{V}_{P-P}$ , $R_L = 1\text{k}\Omega$	●	0.53		MHz

## ELECTRICAL CHARACTERISTICS

**Note 1:** Stresses beyond those listed under Absolute Maximum Ratings may cause permanent damage to the device. Exposure to any Absolute Maximum Rating condition for extended periods may affect device reliability and lifetime.

**Note 2:** A heat sink may be required to keep the junction temperature below the absolute maximum rating when the output is shorted indefinitely.

**Note 3:** The LTC6240C/LTC6240HVC/LTC6241C/LTC6241HVC, LTC6242C/LTC6242HVC are guaranteed to meet specified performance from 0°C to 70°C. They are designed, characterized and expected to meet specified performance from -40°C to 85°C, but are not tested or QA sampled at these temperatures. The LTC6240I/LTC6240HVI, LTC6241I/LTC6241HVI, LTC6242I/LTC6242HVI are guaranteed to meet specified performance from -40°C to 85°C. All versions of the LTC6240H/LTC6241H/LTC6242H are guaranteed to meet specified performance from -40°C to 125°C.

**Note 4:** ESD (Electrostatic Discharge) sensitive device. ESD protection devices are used extensively internal to the LTC6240/LTC6241/LTC6242; however, high electrostatic discharge can damage or degrade the device. Use proper ESD handling precautions.

**Note 5:** Matching parameters are the difference between the two amplifiers A and D and between B and C of the LTC6242; between the two amplifiers of the LTC6241. CMRR and PSRR match are defined as follows: CMRR and PSRR are measured in  $\mu\text{V/V}$  on the matched amplifiers. The difference is calculated between the matching sides in  $\mu\text{V/V}$ . The result is converted to dB.

**Note 6:** This parameter is not 100% tested.

**Note 7:** Bias current at  $T_A = 25^\circ\text{C}$  is 100% tested and guaranteed for the LTC6240 in the S8 package. The LTC6240S5, LTC6241 and LTC6242 are expected to achieve the same performance as the LTC6240S8. All parts are guaranteed to meet specifications over temperature.

**Note 8:** Current noise is calculated from the formula:  $i_n = (2qI_B)^{1/2}$  where  $q = 1.6 \times 10^{-19}$  coulomb. The noise of source resistors up to  $50\text{G}\Omega$  dominates the contribution of current noise. See also Typical Performance Characteristics curve Noise Current vs Frequency.

**Note 9:** Output voltage swings are measured between the output and power supply rails.

**Note 10:** Minimum supply voltage is guaranteed by the power supply rejection ratio test.

**Note 11:** Slew rate is measured in a gain of -2 with  $R_F = 1\text{k}$  and  $R_G = 500\Omega$ . On the LTC6240/LTC6241/LTC6242,  $V_S = \pm 2.5\text{V}$ ,  $V_{IN}$  is  $\pm 1\text{V}$  and  $V_{OUT}$  slew rate is measured between -1V and +1V. On the LTC6240HV/LTC6241HV/LTC6242HV,  $V_{IN}$  is  $\pm 2\text{V}$  and  $V_{OUT}$  slew rate is measured between -2V and +2V.

**Note 12:** Full-power bandwidth is calculated from the slew rate:  

$$\text{FPBW} = \text{SR}/\pi V_{P-P}$$

## TYPICAL PERFORMANCE CHARACTERISTICS

**$V_{OS}$  Distribution LTC6241**



6241 G01

**$V_{OS}$  Distribution LTC6241**



6241 G02

**$V_{OS}$  Temperature Coefficient Distribution LTC6241**



6241 G03

**$V_{OS}$  Distribution LTC6240**

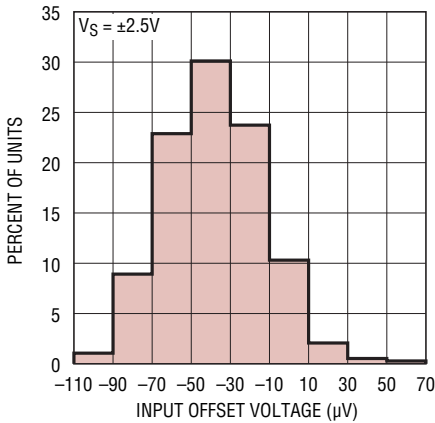

6241 G04

**$V_{OS}$  Temperature Coefficient Distribution LTC6240**

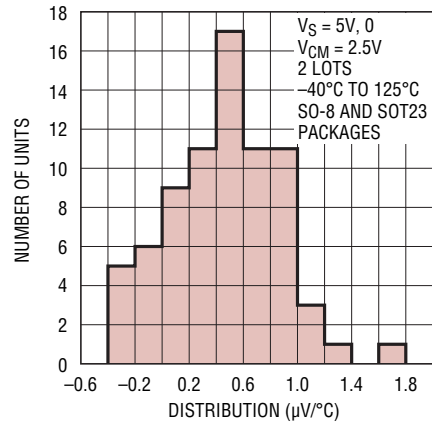

6241 G05

**Supply Current vs Supply Voltage**

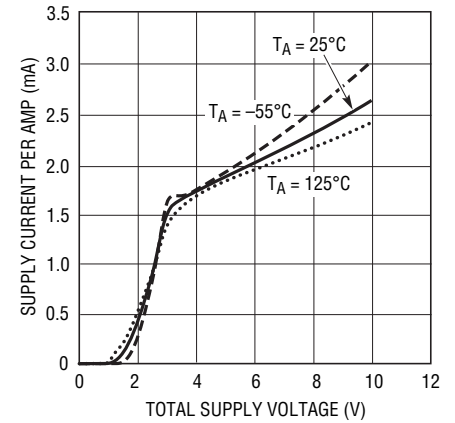

6241 G06

**Offset Voltage vs Input Common Mode Voltage**

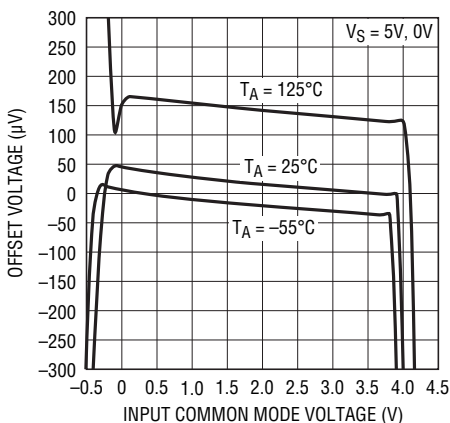

6241 G07

**Input Bias Current vs Common Mode Voltage**

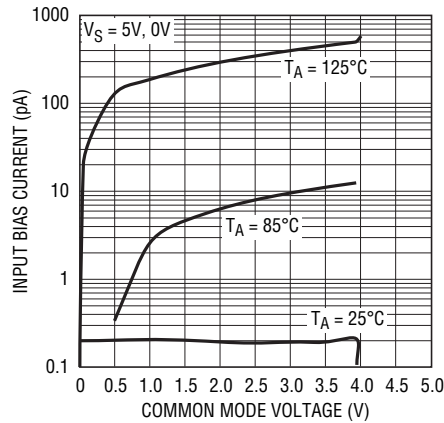

6241 G08

**Input Bias Current vs Common Mode Voltage**

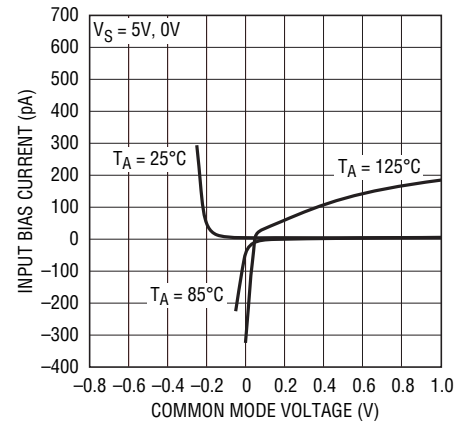

6241 G09

624012fe

# TYPICAL PERFORMANCE CHARACTERISTICS

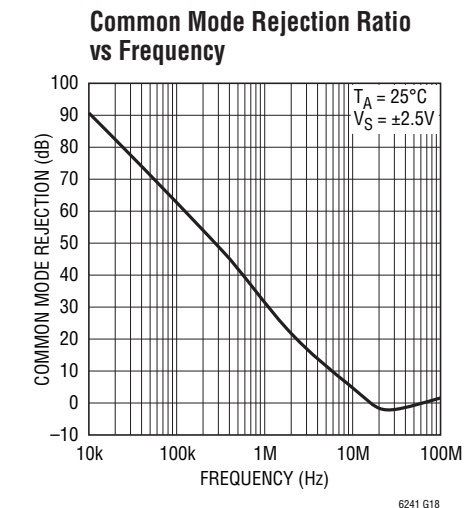
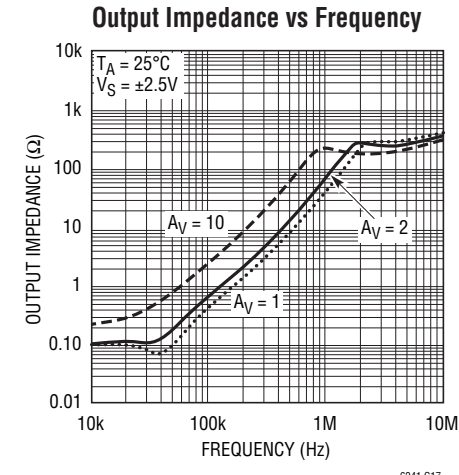
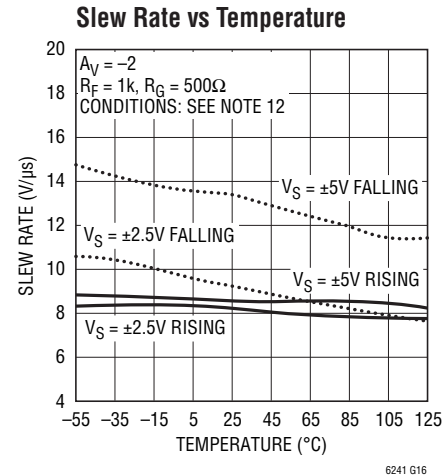
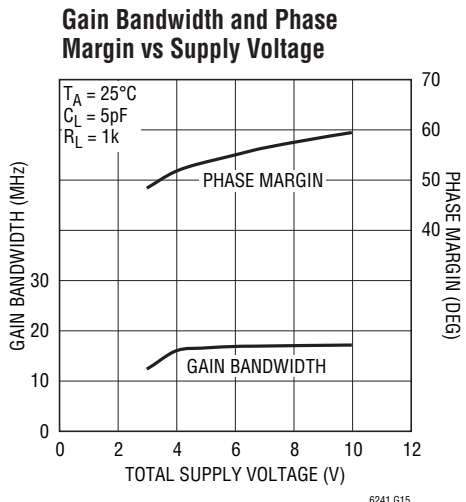
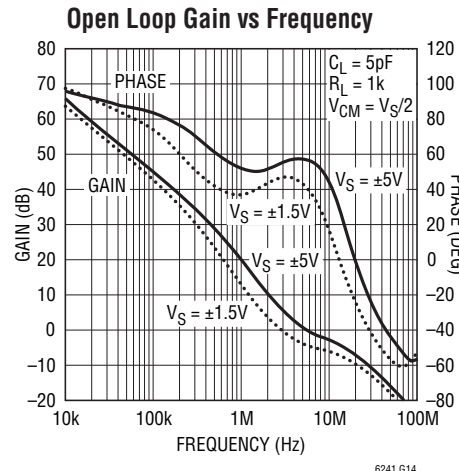
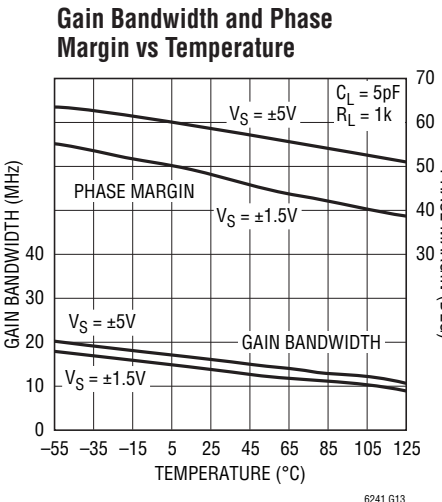
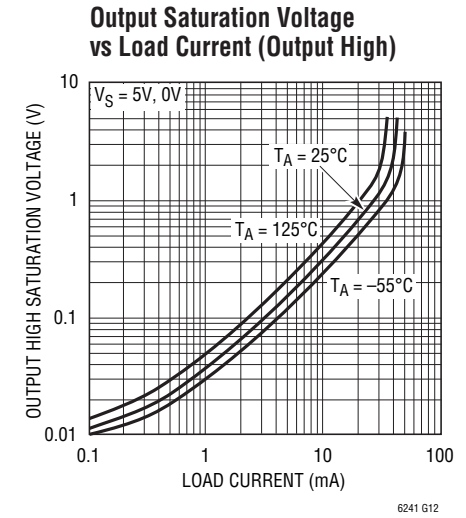
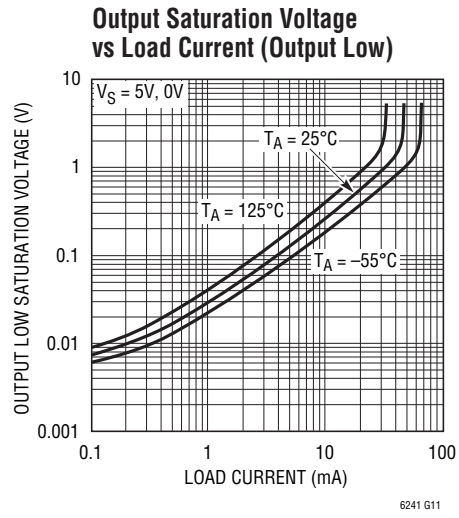
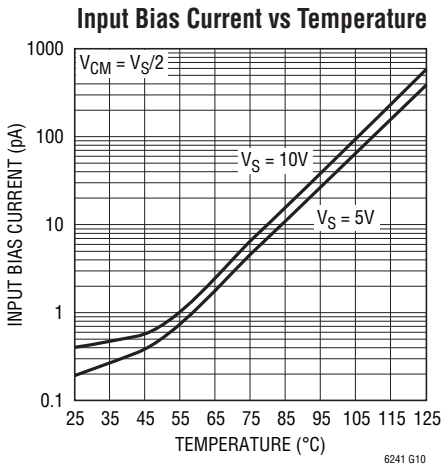

## TYPICAL PERFORMANCE CHARACTERISTICS



6241 G19

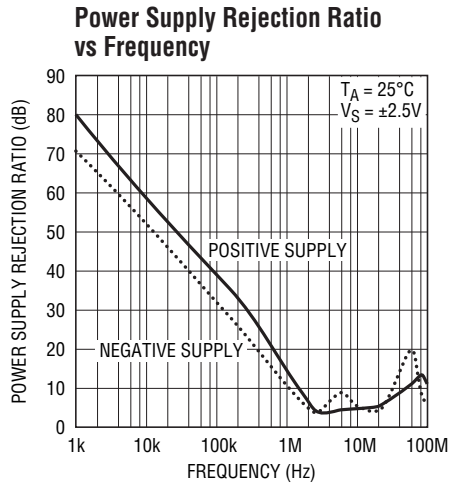

6241 G20

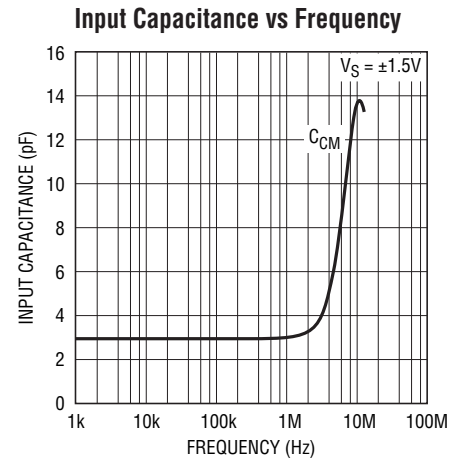

6241 G21



6241 G22

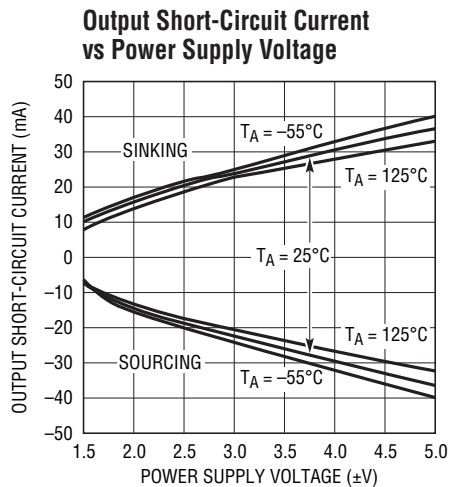

6241 G23



6241 G24

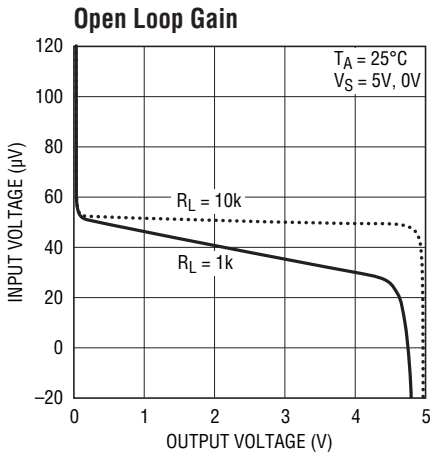

6241 G25

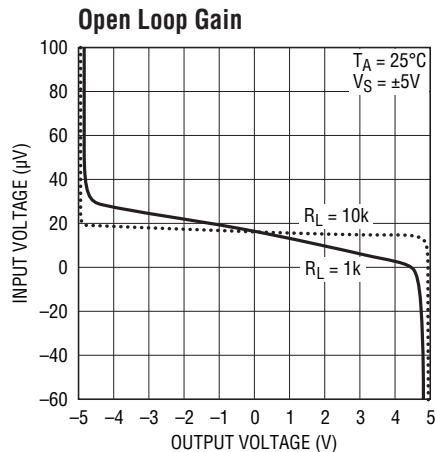

6241 G26

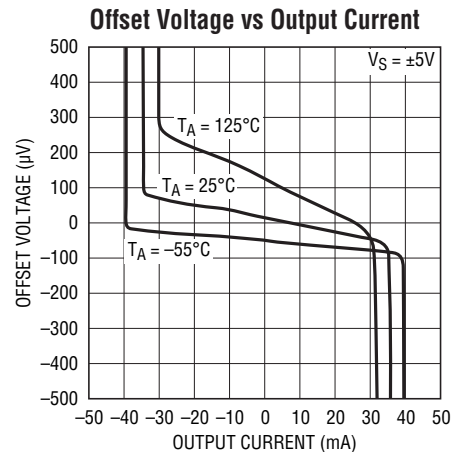

6241 G27

624012fe

# TYPICAL PERFORMANCE CHARACTERISTICS

**Warm-Up Drift vs Time**

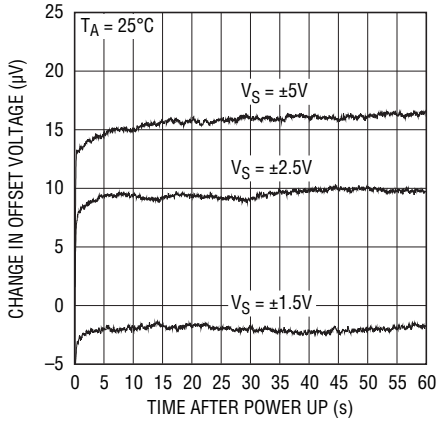

6241 G28

**Noise Voltage vs Frequency**

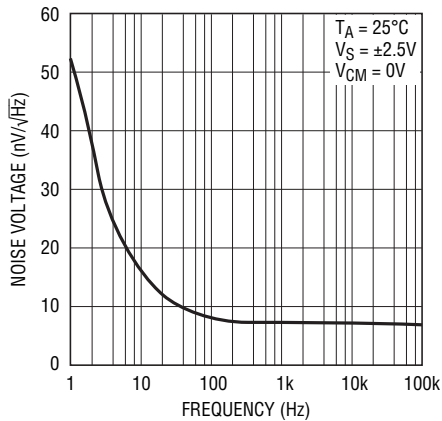

6241 G29

**0.1Hz to 10Hz Voltage Noise**

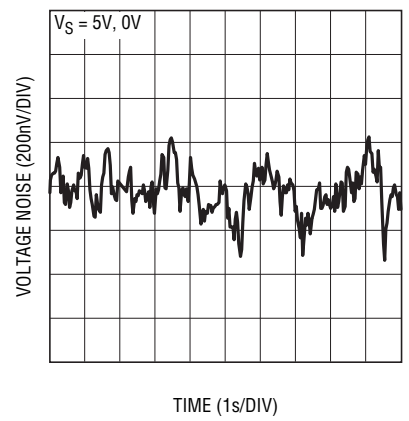

6241 G30

**Noise Current vs Frequency**

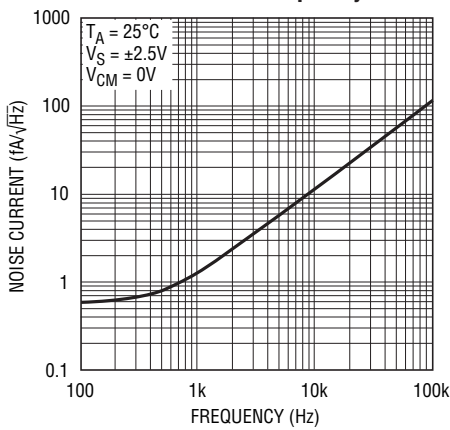

6241 G31

**Series Output Resistance and Overshoot vs Capacitive Load**

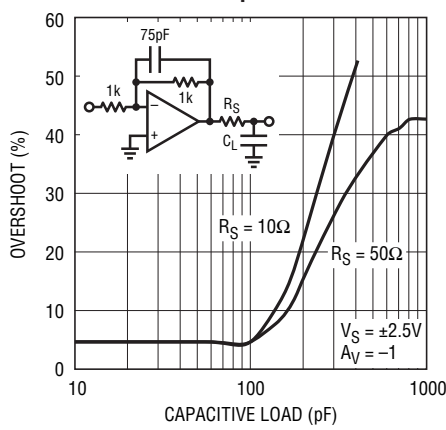

6241 G32

**Minimum Output Series Resistance vs Capacitive Load**

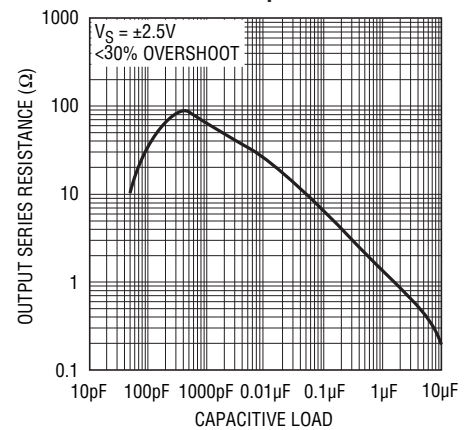

6241 G33

**Series Output Resistance and Overshoot vs Capacitive Load**

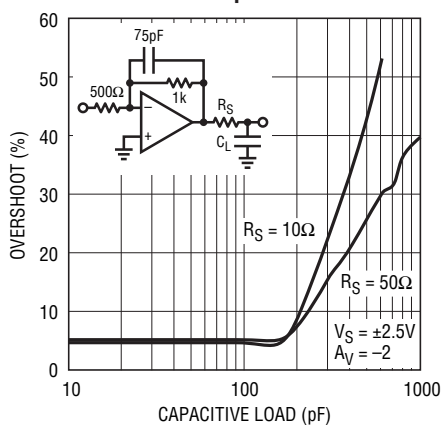

6241 G34

**Settling Time vs Output Step (Non-Inverting)**

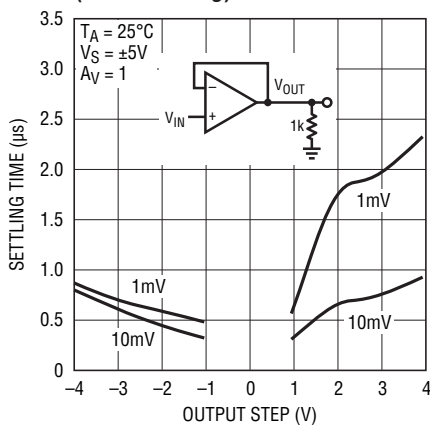

6241 G35

**Settling Time vs Output Step (Inverting)**

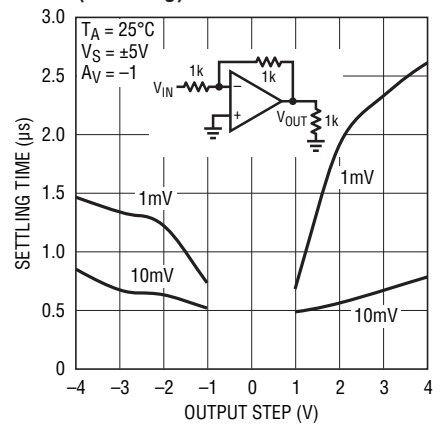

6241 G36

## TYPICAL PERFORMANCE CHARACTERISTICS

**Maximum Undistorted Output Signal vs Frequency**



**Distortion vs Frequency**



**Distortion vs Frequency**



**Distortion vs Frequency**



**Distortion vs Frequency**



**Small Signal Response**

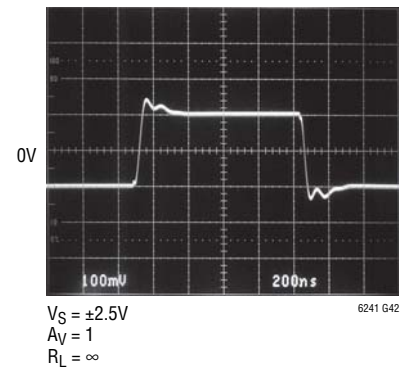

**Large Signal Response**

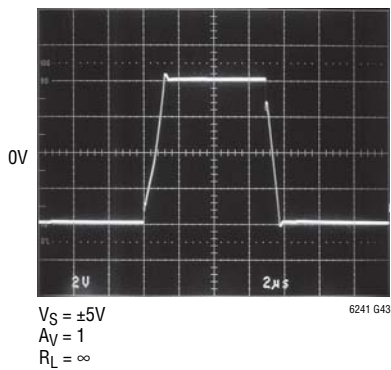

**Large Signal Response**

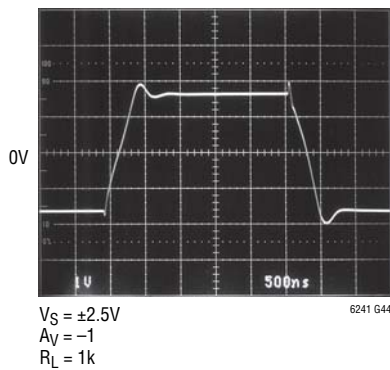

**Output Overdrive Recovery**

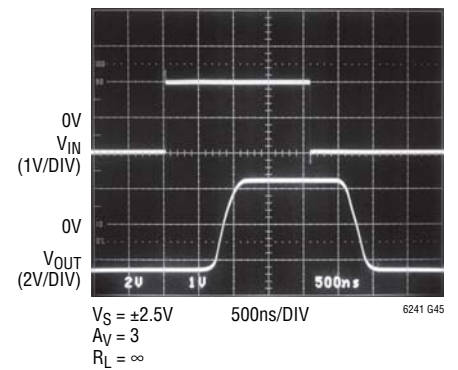

## APPLICATIONS INFORMATION

### Amplifier Characteristics

Figure 1 is a simplified schematic of the amplifier, which has a pair of low noise input transistors M1 and M2. A simple folded cascode Q1, Q2 and R1, R2 allow the input stage to swing to the negative rail, while performing level shift to the differential drive generator. Low offset voltage is accomplished by laser trimming the input stage.

Capacitor C1 reduces the unity cross frequency and improves the frequency stability without degrading the gain bandwidth of the amplifier. Capacitor CM sets the overall amplifier gain bandwidth. The differential drive generator supplies signals to transistors M3 and M4 that swing the output from rail-to-rail.

The photo of Figure 2 shows the output response to an input overdrive with the amplifier connected as a voltage follower. If the negative going input signal is less than a diode drop below  $V^-$ , no phase inversion occurs. For input signals greater than a diode drop below  $V^-$ , limit the current to 3mA with a series resistor  $R_S$  to avoid phase inversion.

### ESD

The LTC6240/LTC6241/LTC6242 have reverse-biased ESD protection diodes on all input and outputs as shown in Figure 1. If these pins are forced beyond either supply, unlimited current will flow through these diodes. If the current is transient and limited to one hundred milliamps or less, no damage to the device will occur.

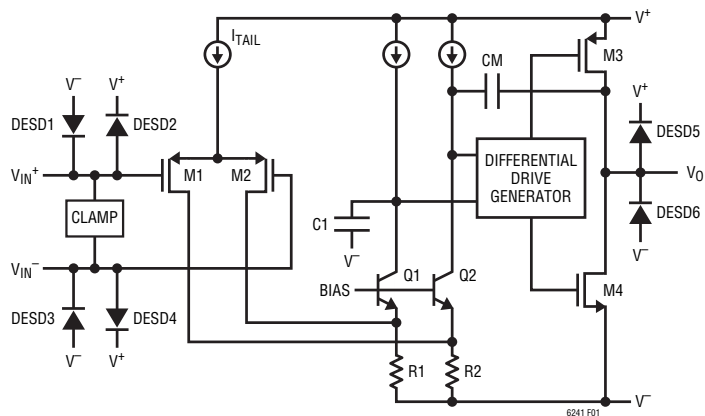

Figure 1. Simplified Schematic

The amplifier input bias current is the leakage current of these ESD diodes. This leakage is a function of the temperature and common mode voltage of the amplifier, as shown in the Typical Performance Characteristics curves.

### Noise

The LTC6240/LTC6241/LTC6242 exhibit exceptionally low 1/f noise in the 0.1Hz to 10Hz region. This 550nV<sub>P-P</sub> noise allows these op amps to be used in a wide variety of high impedance low frequency applications, where zero-drift amplifiers might be inappropriate due to their charge injection.

In the frequency region above 1kHz the LTC6240/LTC6241/LTC6242 also show good noise voltage performance. In this frequency region, noise can easily be dominated by the total source resistance of the particular application. Specifically, these amplifiers exhibit the noise of a 3.1kΩ resistor, meaning it is desirable to keep the source and feedback resistance at or below this value, i.e.  $R_S + R_G || R_{FB} \leq 3.1k\Omega$ . Above this total source impedance, the noise voltage is not dominated by the amplifier.

Noise current can be estimated from the expression  $i_n = \sqrt{2qI_B}$ , where  $q = 1.6 \cdot 10^{-19}$  coulombs. Equating  $\sqrt{4kTR\Delta f}$  and  $R\sqrt{2qI_B\Delta f}$  shows that for source resistors below 50GΩ the amplifier noise is dominated by the source resistance. See the Typical Performance Characteristics curve Noise Current vs Frequency.

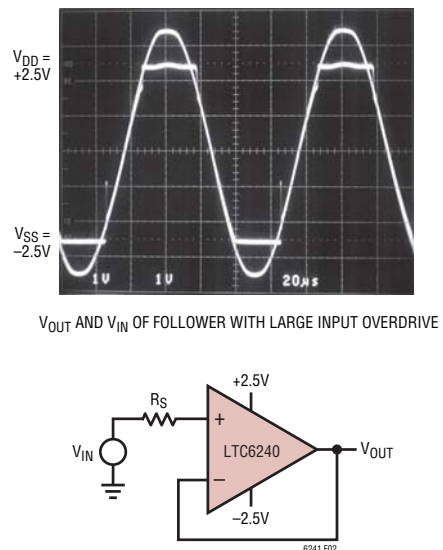

Figure 2. Unity Gain Follower Test Circuit

## APPLICATIONS INFORMATION

Proprietary design techniques are used to obtain simultaneous low  $1/f$  noise and low input capacitance. Low input capacitance is important when the amplifier is used with high value source and feedback resistors. High frequency noise from the amplifier tail current source,  $I_{TAIL}$  in Figure 1, couples through the input capacitance and appears across these large source and feedback resistors. As an example, the photodiode amplifier of Figure 15 on the last page of this data sheet shows the noise results from the LTC6241 and the results of a competitive CMOS amplifier. The LTC6241 output is the ideal noise of a  $1M\Omega$  resistor at room temperature,  $130nV\sqrt{Hz}$ .



Figure 3. Parallel Amplifier Lowers Noise by 2x

### Half the Noise

The circuit shown in Figure 3 can be used to achieve even lower noise voltage. By paralleling 4 amplifiers the noise voltage can be lowered by  $\sqrt{4}$ , or half as much noise. The  $\sqrt{\quad}$  comes about from an RMS summing of uncorrelated noise sources. This circuit maintains extremely high input resistance, and has a  $250\Omega$  output resistance. For lower output resistance, a buffer amplifier can be added without influencing the noise.

### Stability

The good noise performance of these op amps can be attributed to large input devices in the differential pair. Above several hundred kilohertz, the input capacitance rises and can cause amplifier stability problems if left unchecked. When the feedback around the op amp is resistive ( $R_F$ ), a pole will be created with  $R_F$ , the source resistance, source capacitance ( $R_S, C_S$ ), and the amplifier input capacitance. In low gain configurations and with  $R_F$  and  $R_S$  in even the kilohm range (Figure 4), this pole can create excess phase shift and possibly oscillation. A small capacitor  $C_F$  in parallel with  $R_F$  eliminates this problem.

### Low Noise Single-Ended Input to Differential Output Amplifier

The circuit on the first page of the data sheet is a low noise single-ended input to differential output amplifier, with a  $200k$  input impedance. The very low input bias current of the LTC6241 allows for these large input and feedback resistors. The  $200k$  resistors,  $R_1$  and  $R_2$ , along with  $C_1$  and  $C_2$  set the  $-3dB$  bandwidth to  $80kHz$ . Capacitor  $C_3$  is used to cancel effects of input capacitance, while  $C_4$  adds phase lead to compensate the phase lag of the second amplifier.



Figure 4. Compensating Input Capacitance

## APPLICATIONS INFORMATION

The op amp's good input offset voltage match and low input bias current means that the typical differential output offset voltage is less than 40 $\mu$ V. A noise spectrum plot of the differential output is shown in Figure 5.

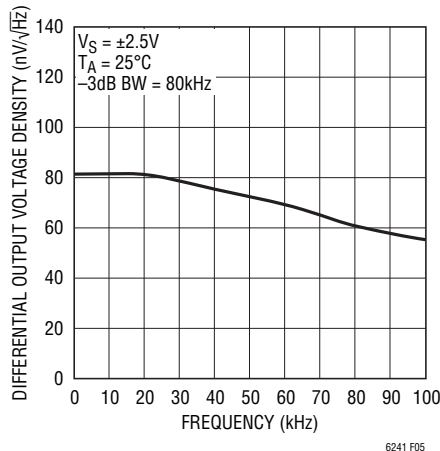

Figure 5. Differential Output Noise

### Achieving Low Input Bias Current

The DD package is leadless and makes contact to the PCB beneath the package. Solder flux used during the attachment of the part to the PCB can create leakage current paths and can degrade the input bias current performance of the part. All inputs are susceptible because the backside paddle is connected to  $V^-$  internally. As the input voltage changes or if  $V^-$  changes, a leakage path can be formed and alter the observed input bias current. For lowest bias current, use the LTC6240/LTC6241 in the SO-8 and provide a guard ring around the inputs that are tied to a potential near the input voltage.

### Layout Considerations and a PCB Guard Ring

In high source impedance applications such as pH probes, photodiodes, strain gauges, et cetera, the low input bias current of these parts requires a clean board layout to minimize additional leakage current into a high impedance signal node. A mere 100G $\Omega$  of PC board resistance between a 5V supply trace and an input trace adds 50pA of leakage current, far greater than the input bias current of the operational amplifier. A guard ring around the high impedance input traces driven by a low impedance source equal to the input voltage prevents such leakage problems.

The guard ring should extend as far as necessary to shield the high impedance signal from any and all leakage paths. Figure 6 shows the use of a guard ring on the LTC6241 in a unity gain configuration. In this case the guard ring is connected to the output and is shielding the high impedance noninverting input from  $V^-$ . Figure 7 shows the inverting gain configuration.

### A Digitally Programmable AC Difference Amplifier

The LTC6241 configured as a difference amplifier, can be combined with a programmable gain amplifier (PGA) to obtain a low noise high speed programmable difference amplifier. Figure 8 shows the LTC6241 based as a single-supply AC amplifier. One LTC6241 op amp is used at the circuit's input as a standard four resistor difference amplifier.

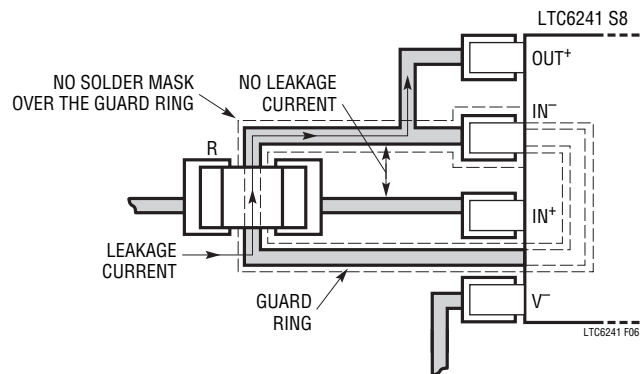

Figure 6. Sample Layout. Unity Gain Configuration, Using Guard Ring to Shield High Impedance Input from Board Leakage

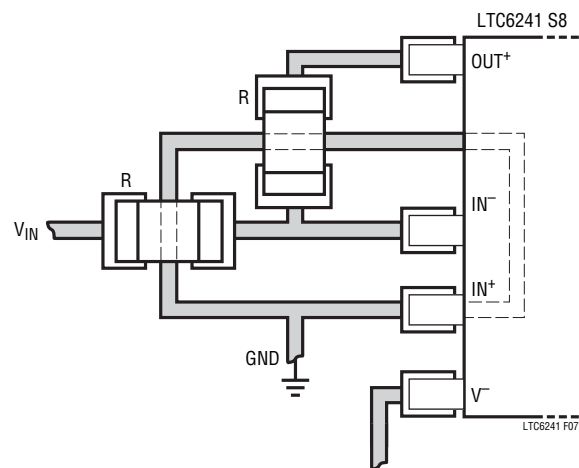
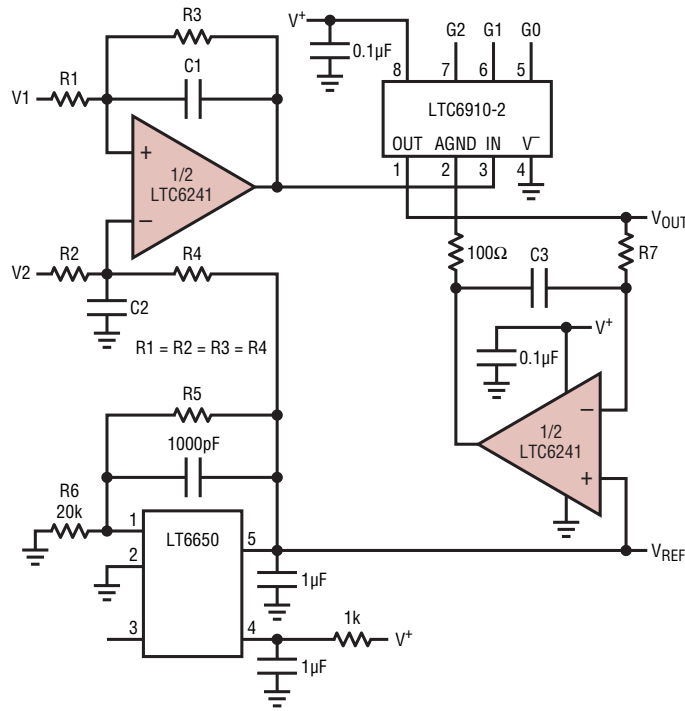

Figure 7. Sample Layout. Inverting Gain Configuration, Using Guard Ring to Shield High Impedance Input from Board Leakage

APPLICATIONS INFORMATION



DIGITAL INPUTS			GAIN
G2	G1	G0	
0	0	0	0
0	0	1	-1
0	1	0	-2
0	1	1	-4
1	0	0	-8
1	0	1	-16
1	1	0	-32
1	1	1	-64

$$V_{OUT} = (V_1 - V_2) \text{ GAIN} + V_{REF}$$

$$V_{REF} = 0.4 \cdot \left( \frac{R_5}{R_6} + 1 \right)$$

$$R_5 = 10k \cdot (5 \cdot V_{REF} - 2) \quad R_6 = 20k$$

$$-3\text{dB BANDWIDTH} = (f_{HIGH} - f_{LOW})$$

$$f_{HIGH} = \frac{1}{2 \cdot \pi \cdot R_3 \cdot C_1} \quad f_{LOW} = \frac{\text{GAIN}}{2 \cdot \pi \cdot R_7 \cdot C_3}$$

Figure 8. Wideband Difference Amplifier with High Input Impedance and Digitally Programmable Gain

The low bias current and current noise of the LTC6241 allow the use of high valued input resistors, 100k or greater. Resistors R1, R2, R3 and R4 are equal and the gain of the difference amplifier is one. An LTC6910-2 PGA amplifies the difference amplifier output with inverting gains of -1, -2, -4, -8, -16, -32 and -64. The second LTC6241 op amp is used as an integrator to set the DC output voltage equal to the LT6650 reference voltage VREF. The integrator drives the PGA analog ground to provide a feedback loop, in addition to blocking any DC voltage through the PGA. The reference voltage of the LT6650 can be set to a voltage from 400mV to V+ - 350mV with resistors R5 and R6. If R6 is 20k or less, the error due to the LT6650 op amp bias current is negligible. The low voltage offset and drift of the LTC6241 integrator will not

contribute any significant error to the LT6650 reference voltage. The LT6650 VREF voltage has a maximum error of ±2% with 1% resistors. The upper -3dB frequency of the amplifier is set by resistor R3 and capacitor C1 and is limited by the bandwidth of the PGA when operated at a gain of 64. Capacitor C2 is equal to C1 and is added to maintain good common mode rejection at high frequency. The lower -3dB frequency is set by the integrator resistor R7, capacitor C3, and the gain setting of the LTC6910-2 PGA. This lower -3dB zero frequency is multiplied by the PGA gain. The rail-to-rail output of the LTC6910-2 PGA allows for a maximum output peak-to-peak voltage equal to twice the VREF voltage. At the maximum gain setting of 64, the maximum peak-to-peak difference between inputs V1 and V2 is equal to twice VREF divided by 64.

**Example Design:** Design a programmable gain AC difference amplifier, with a bandwidth of at least 10Hz to 100kHz, an input impedance equal to or greater than 100kΩ, and an output DC reference equal to 1V.

- Select input resistors R1, R2, R3 and R4 equal to 100k.
- If the upper -3dB frequency is 100kHz then  $C_1 = 1/(2\pi \cdot R_2 \cdot f_{3dB}) = 1/(6.28 \cdot 100k\Omega \cdot 100kHz) = 15\text{pF}$  (to the nearest 5% value) and  $C_2 = C_1 = 15\text{pF}$ .
- Select R7 equal to one 1M and set the lower -3dB frequency to 10Hz at the highest PGA gain of 64, then  $C_3 = \text{Gain}/(2\pi \cdot R_7 \cdot f_{3dB}) = 64/(6.28 \cdot 100k\Omega \cdot 10\text{Hz}) = 1\mu\text{F}$ . Lower gains settings will give a lower f3dB.
- Calculate the value of R5 to set the LT6650 reference equal to 1V;

$$V_{REF} = 0.4(R_5/R_6 + 1), \text{ so } R_5 = R_6(2.5V_{REF} - 1). \text{ For } R_6 = 20k\Omega, R_5 = 30k\Omega$$

With VREF = 1V the maximum input difference voltage is equal to  $2V/64 = 31.2\text{mV}$ .

40nVpp Noise, 0.05µV/°C Drift, Chopped FET Amplifier

Figure 9's circuit combines the ±5V rail-to-rail performance of the LTC6241HV with a pair of extremely low noise JFETs configured in a chopper based carrier modulation scheme

## APPLICATIONS INFORMATION

to achieve an extraordinarily low noise and low DC drift. The performance of this circuit is suited for the demanding transducer signal conditioning situations such as high resolution scales and magnetic search coils.

The LTC1799's output is divided down to form a 2-phase 925Hz square wave clock. This frequency, harmonically unrelated to 60Hz, provides excellent immunity to harmonic beating or mixing effects which could cause instabilities. S1 and S2 receive complementary drive, causing A1 to see a chopped version of the input voltage. A1's square wave output is synchronously demodulated by S3 and S4. Because these switches are synchronously driven

with the input chopper, proper amplitude and polarity information is presented to A2, the DC output amplifier. This stage integrates the square wave into a DC voltage, providing the output. The output is divided down (R2 and R1) and fed back to the input chopper where it serves as a zero signal reference. Gain, in this case 1000, is set by the R1-R2 ratio. Because A1 is AC coupled, its DC offset and drift do not affect the overall circuit offset, resulting in the extremely low offset and drift noted. The JFETs have an input RC damper that minimizes offset voltage contribution due to parasitic switch behavior, resulting in the 1µV offset specification.



Figure 9. Ultralow Noise Chopper Amplifier

## APPLICATIONS INFORMATION

The noise measured over a 50 second interval, in Figure 10, is 40nV in a 0.1Hz to 10Hz bandwidth. This low noise is attributed to the input JFET's die size and current density.



Figure 10. Noise in a 0.1Hz to 10Hz Bandwidth

### Low Noise Shock Sensor Amplifiers

Figures 11 and 12 show the amplifiers realizing two different approaches to amplifying signals from a capacitive sensor. The sensor in both cases is a 770pF piezoelectric shock sensor accelerometer, which generates charge under physical acceleration.

Figure 11 shows the classical “charge amplifier” approach. The LTC6240 is in the inverting configuration so the sensor looks into a virtual ground. All of the charge generated



Figure 11. Classical Inverting Charge Amplifier

by the sensor is forced across the feedback capacitor by the op amp action. Because the feedback capacitor is 100 times smaller than the sensor, it will be forced to 100 times what would have been the sensor's open circuit voltage. So the circuit gain is 100. The benefit of this approach is that the signal gain of the circuit is independent of any cable capacitance introduced between the sensor and the amplifier. Hence this circuit is favored for remote accelerometers where the cable length may vary. Difficulties with the circuit are inaccuracy of the gain setting with the small capacitor, and low frequency cutoff due to the bias resistor working into the small feedback capacitor.

Figure 12 shows a noninverting amplifier approach. This approach has many advantages. First of all, the gain is set accurately with resistors rather than with a small capacitor. Second, the low frequency cutoff is dictated by the bias resistor working into the large 770pF sensor, rather than into a small feedback capacitor, for lower frequency response. Third, the noninverting topology can be paralleled and summed (as shown) for scalable reductions in voltage noise. The only drawback to this circuit is that the parasitic capacitance at the input reduces the gain slightly. This circuit is favored in cases where parasitic input capacitances such as traces and cables will be relatively small and invariant.



Figure 12. Low Noise Noninverting Shock Sensor Amplifier

## APPLICATIONS INFORMATION

### 1M Transimpedance Amplifier with $43\text{nV}/\sqrt{\text{Hz}}$ Output Noise

In a normal 1M transimpedance amplifier, like that shown on the back page of this data sheet, the output noise density must be at least  $130\text{nV}/\sqrt{\text{Hz}}$  at room temperature. This is true even should the op amp be perfectly noiseless, because the 1M resistor provides  $130\text{nV}/\sqrt{\text{Hz}}$  of voltage noise at room temperature independently of the op amp.

The circuit of Figure 13 provides an overall transimpedance gain of  $1\text{M}\Omega$ , but it has an output noise density of only  $43\text{nV}/\sqrt{\text{Hz}}$ , about 1/3 of the normal transimpedance amplifier. It does this by taking a higher initial transimpedance gain of  $10\text{M}$  and then attenuating by a factor of 10. The transistor section provides voltage gain and works on a 54V supply voltage to guarantee adequate output swing.

By achieving an output swing of 50V before attenuation, the circuit provides an output swing to 5V after attenuation. The  $10\text{M}$  resistor sets the gain of the TIA stage and has a noise density of  $400\text{nV}/\sqrt{\text{Hz}}$ . After attenuation, the effective TIA gain drops to  $1\text{M}$  while the noise floor drops to  $40\text{nV}/\sqrt{\text{Hz}}$ , which clearly dominates the observed  $43\text{nV}/\sqrt{\text{Hz}}$ . Note the additional benefit that the offset voltage of the op amp is divided by 10. Worst-case output offset for this circuit is  $150\mu\text{V}$  over temperature.

### Reference Buffer

Figure 14 shows the LTC6240 being utilized as a buffer in conjunction with the LT1019 reference. The passive R-C filter attenuates the reference noise and the LTC6240 provides a low noise buffer, resulting in an output noise of  $8\text{nV}/\sqrt{\text{Hz}}$ .

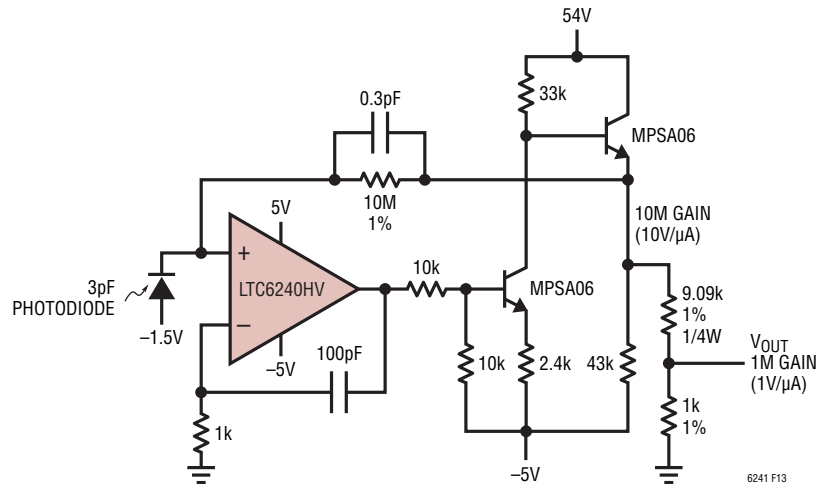

Figure 13. 1M Transimpedance Amplifier with  $43\text{nV}/\sqrt{\text{Hz}}$  Output Noise



Figure 14. Low Noise Reference Buffer

**PACKAGE DESCRIPTION**

**DD Package**  
**8-Lead Plastic DFN (3mm × 3mm)**  
 (Reference LTC DWG # 05-08-1698)

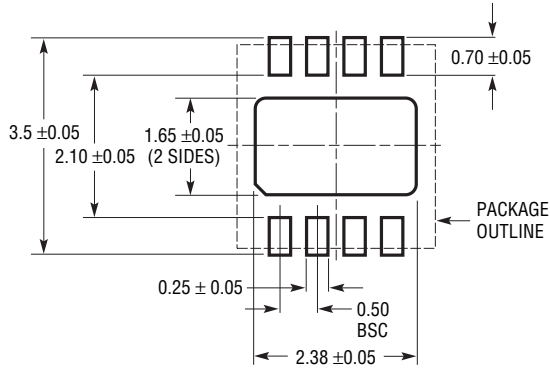

RECOMMENDED SOLDER PAD PITCH AND DIMENSIONS  
 APPLY SOLDER MASK TO AREAS THAT ARE NOT SOLDERED

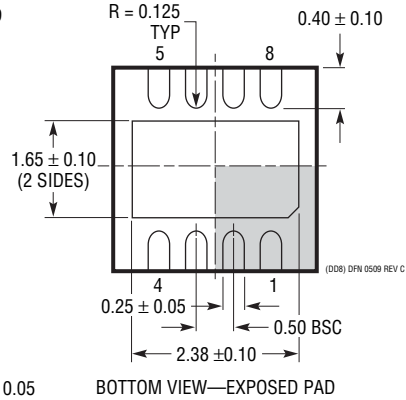

- NOTE:
1. DRAWING TO BE MADE A JEDEC PACKAGE OUTLINE M0-229 VARIATION OF (WEED-1)
  2. DRAWING NOT TO SCALE
  3. ALL DIMENSIONS ARE IN MILLIMETERS
  4. DIMENSIONS OF EXPOSED PAD ON BOTTOM OF PACKAGE DO NOT INCLUDE MOLD FLASH. MOLD FLASH, IF PRESENT, SHALL NOT EXCEED 0.15mm ON ANY SIDE
  5. EXPOSED PAD SHALL BE SOLDER PLATED
  6. SHADED AREA IS ONLY A REFERENCE FOR PIN 1 LOCATION ON TOP AND BOTTOM OF PACKAGE

# PACKAGE DESCRIPTION

**DHC Package**  
**16-Lead Plastic DFN (5mm × 3mm)**  
 (Reference LTC DWG # 05-08-1706)

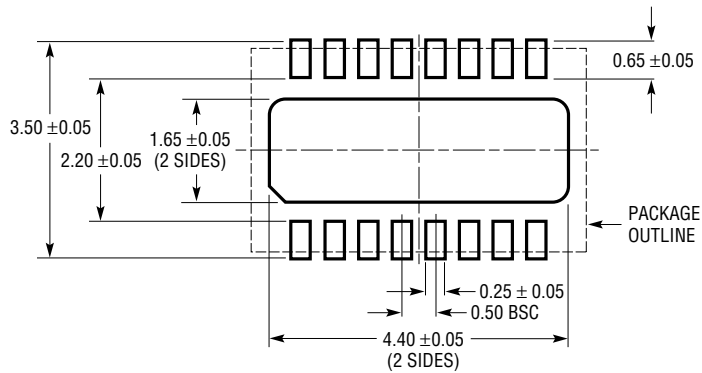

**RECOMMENDED SOLDER PAD PITCH AND DIMENSIONS**

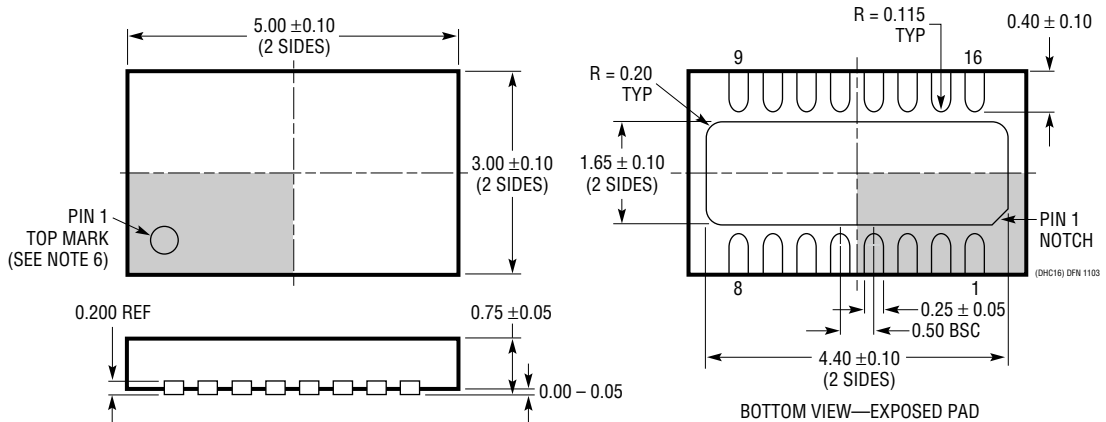

- NOTE:
1. DRAWING PROPOSED TO BE MADE VARIATION OF VERSION (WJED-1) IN JEDEC PACKAGE OUTLINE MO-229
  2. DRAWING NOT TO SCALE
  3. ALL DIMENSIONS ARE IN MILLIMETERS
  4. DIMENSIONS OF EXPOSED PAD ON BOTTOM OF PACKAGE DO NOT INCLUDE MOLD FLASH. MOLD FLASH, IF PRESENT, SHALL NOT EXCEED 0.15mm ON ANY SIDE
  5. EXPOSED PAD SHALL BE SOLDER PLATED
  6. SHADED AREA IS ONLY A REFERENCE FOR PIN 1 LOCATION ON THE TOP AND BOTTOM OF PACKAGE

## PACKAGE DESCRIPTION

### GN Package 16-Lead Plastic SSOP (Narrow .150 Inch) (Reference LTC DWG # 05-08-1641)



**NOTE:**

1. CONTROLLING DIMENSION: INCHES

2. DIMENSIONS ARE IN  $\frac{\text{INCHES}}{\text{(MILLIMETERS)}}$

3. DRAWING NOT TO SCALE

\*DIMENSION DOES NOT INCLUDE MOLD FLASH. MOLD FLASH SHALL NOT EXCEED  $0.006^*$  (0.152mm) PER SIDE

\*\*DIMENSION DOES NOT INCLUDE INTERLEAD FLASH. INTERLEAD FLASH SHALL NOT EXCEED  $0.010^*$  (0.254mm) PER SIDE

**PACKAGE DESCRIPTION**

**S5 Package  
5-Lead Plastic TSOT-23**

(Reference LTC DWG # 05-08-1635 Rev B)

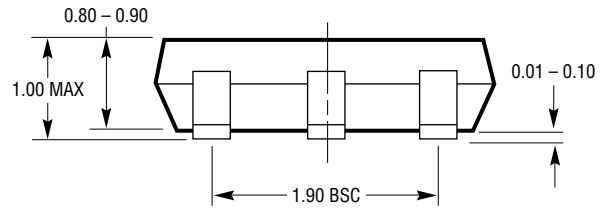
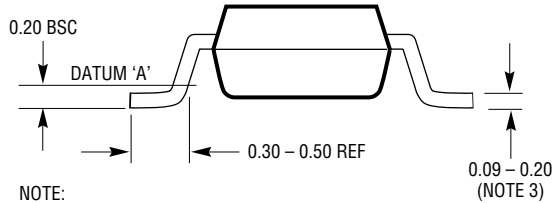
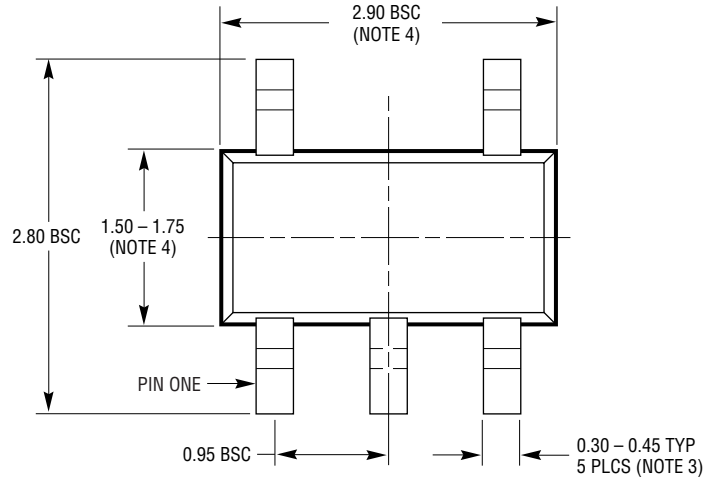
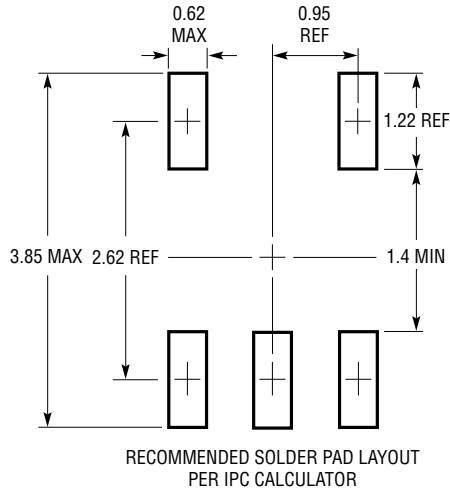

- NOTE:
1. DIMENSIONS ARE IN MILLIMETERS
  2. DRAWING NOT TO SCALE
  3. DIMENSIONS ARE INCLUSIVE OF PLATING
  4. DIMENSIONS ARE EXCLUSIVE OF MOLD FLASH AND METAL BURR
  5. MOLD FLASH SHALL NOT EXCEED 0.254mm
  6. JEDEC PACKAGE REFERENCE IS MO-193

S5 TSOT-23 0302 REV B

## PACKAGE DESCRIPTION

### S8 Package 8-Lead Plastic Small Outline (Narrow .150 Inch) (Reference LTC DWG # 05-08-1610)



RECOMMENDED SOLDER PAD LAYOUT



- NOTE:
1. DIMENSIONS IN  $\frac{\text{INCHES}}{\text{MILLIMETERS}}$
  2. DRAWING NOT TO SCALE
  3. THESE DIMENSIONS DO NOT INCLUDE MOLD FLASH OR PROTRUSIONS. MOLD FLASH OR PROTRUSIONS SHALL NOT EXCEED .006" (0.15mm)

S08 0303

**REVISION HISTORY** (Revision history begins at Rev E)

REV	DATE	DESCRIPTION	PAGE NUMBER
E	07/10	Update to Simplified Schematic (Figure 1)	19

## TYPICAL APPLICATION

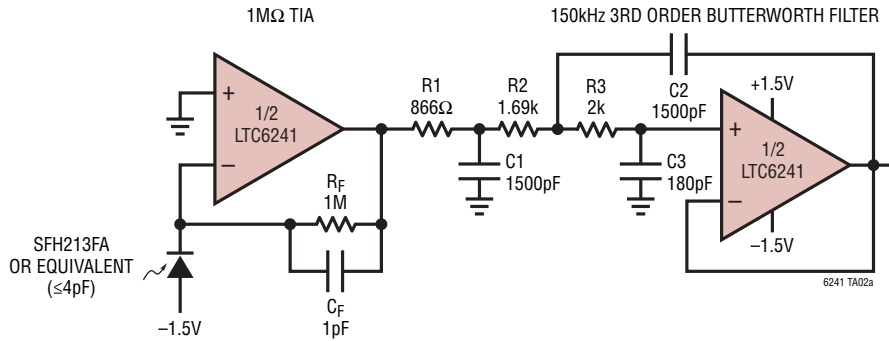
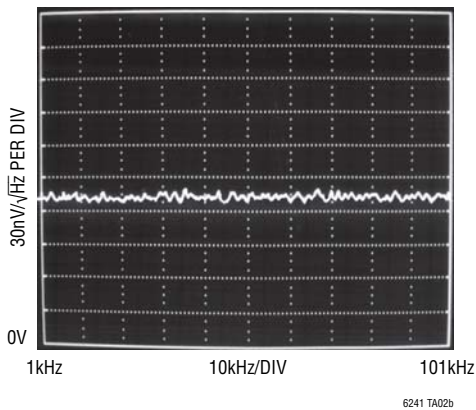
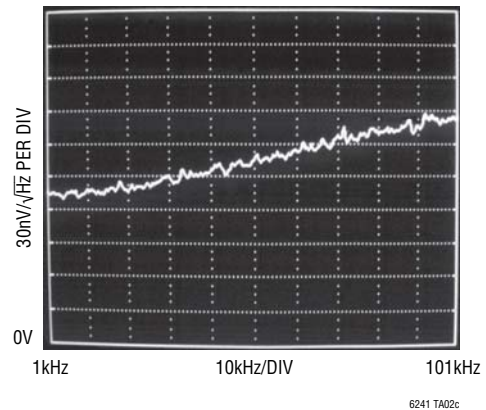

Figure 15. Ultralow Noise 1MΩ 150kHz Photodiode Amplifier

LTC6241 Output Noise Spectrum. 1MΩ Resistor Noise Dominates; Ideal Performance



Competition Output Noise Spectrum. Op Amp Noise Dominates; Performance Compromised



## RELATED PARTS

PART NUMBER	DESCRIPTION	COMMENTS
LTC1151	±15V Zero-Drift Op Amp	Dual High Voltage Operation ±18V
LT1792	Low Noise Precision JFET Op Amp	6nV/√Hz Noise, ±15V Operation
LTC2050	Zero-Drift Op Amp	2.7 Volt Operation, SOT-23
LTC2051/LTC2052	Dual/Quad Zero-Drift Op Amp	Dual/Quad Version of LTC2050 in MS8/GN16 Packages
LTC2054/LTC2055	Single/Dual Zero-Drift Op Amp	Micropower Version of the LTC2050/LTC2051 in SOT-23 and DD Packages
LTC6244	Dual 50MHz Rail-to-Rail Op Amp	100μV V <sub>OS(MAX)</sub> , 1pA I <sub>BIAS</sub> , 40V/μV, Slew Rate

## Looking for pricing, stock, or lifecycle information?

Click below to explore more details on WIN SOURCE:

- ⊖ [View LTC6242HVIGN#TRPBF on WIN SOURCE](#)
- ⊖ [Analog Devices Inc. Information](#)

## Optimize Your Supply Chain with WIN SOURCE Solutions

- ✓ Global Sourcing Solution
- ✓ Obsolete Management
- ✓ Cost Control Management
- ✓ Shortage Management
- ✓ Alternative Solution
- ✓ Excess Inventory Management