



**THE DATASHEET OF
LYT2005K-TL**



LYT2002-2005 LYTSwitch-2 Family

Energy-Efficient, Accurate Primary-Side Regulation
CC/CV Switcher for LED Lighting Applications

Product Highlights

Accurate CC Regulation, Meets $\pm 3\%$ in a Typical Design¹

Controller Automatically Compensates For:

- Transformer inductance variation
 - External component changes with temperature
 - Input line voltage variations
- This enhances production yield

Cost-Effective, Small Size Designs

- Eliminates the optocoupler and secondary CC control circuitry
- Eliminates control loop compensation circuitry
- Frequency-jitter greatly reduces EMI filter cost
- Programmable switching frequency reduces transformer size
- 725 V switching power MOSFET enables clampless flyback designs

Advanced Protection/Safety Features

- Auto-restart protection reduces power delivered by >90% for output short-circuit and control loop faults (open and short-circuit components)
- Hysteretic thermal shutdown – with automatic recovery
- Meets high-voltage creepage requirements between DRAIN and all other pins both on the PCB and at the package

EcoSmart™ – Energy Efficient

- No-load consumption <30 mW¹
- No current sense resistors – maximizes efficiency

Green Package

- All parts are halogen free and RoHS compliant

Applications

- LED bulbs, down lights, luminaires, ballasts and T8 tubes

Description

The LYTSwitch™-2 family of ICs dramatically simplifies low power CC LED drivers by eliminating the optocoupler and secondary control circuitry. The family introduces a revolutionary control technique which provides accurate output current regulation, compensating for transformer and external component variations, and device parameter tolerances as well as input voltage variations.

The device incorporates a high-voltage switching MOSFET, an ON/OFF control state-machine, a high-voltage switched current source for self-biasing, frequency jitter to reduce EMI, cycle-by-cycle current limit and hysteretic thermal shutdown circuitry into a monolithic IC. This high level of integration enables cost-effective designs with very few external components, reducing solution cost and driver size.

LYTSwitch-2 parts minimize energy consumption when the output is unloaded. Practical designs can easily achieve less than 30 mW no-load consumption.

The 725 V power MOSFET used in LYTSwitch-2 devices increases the circuits' ability to withstand input surge. In addition, each package is designed to maximize the creepage distance between high-voltage pins and logic level inputs. This increased pin spacing increases driver lifetime and reliability in polluted environments. These in-built protection features also protect the entire circuit from excess temperature operation, increasing lifetime in thermally challenging environments.

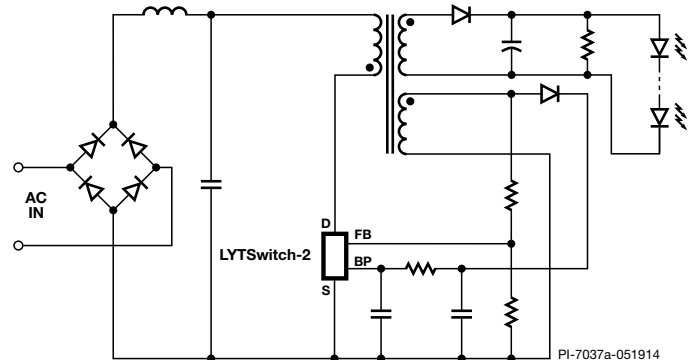

Figure 1. Typical Flyback Implementation – Not a Simplified Circuit.

Output Power Table²

Product ⁵	90-308 VAC	
	Enclosed Bulb ³	Ballast Driver ⁴
LYT2002D	5 W	6 W
LYT2003D	6 W	7 W
LYT2004D	7 W	8 W
LYT2004E/K	9 W	10 W
LYT2005E/K	10 W	12 W

Table 1. Output Power Table.

Notes:

1. Nominal input and bias supply applied to BYPASS pin.
2. Performance for typical design.
3. Maximum continuous power in a typical non-ventilated bulb measured at +50 °C ambient, device $T_j \leq 100$ °C.
4. Maximum practical continuous power in an open frame design with adequate heat sinking, measured at +50 °C.
5. Packages: D: SO-8C, E: eSIP-7C, K: eSOP-12B.

LYTSwitch-2 Functional Description

The LYTSwitch-2 IC combines a high-voltage power MOSFET switch with a power supply controller in one device. Similar to the LinkSwitch™-LP and TinySwitch™-III ICs it uses an ON/OFF control to regulate the output voltage. In addition, the switching frequency is modulated to regulate the output current to provide a constant current characteristic. The LYTSwitch-2 controller consists of an oscillator, feedback (sense and logic) circuit, 6 V regulator, over-temperature protection, frequency jittering, current limit circuit, leading-edge blanking, inductance correction circuitry, frequency control for constant current regulation and ON/OFF state-machine for CV control.

Inductance Correction Circuitry

If the primary magnetizing inductance is either too high or low the converter will automatically compensate for this by adjusting the oscillator frequency. Since this controller is designed to operate in discontinuous-conduction mode the output power is directly proportional to the set primary inductance and its tolerance can be completely compensated with adjustments to the switching frequency.

Constant Current (CC) Operation

As the output voltage and therefore the flyback voltage across the bias winding ramps up, the FEEDBACK pin voltage increases. The switching frequency is adjusted as the FEEDBACK pin voltage increases to provide a constant output current regulation. The constant current circuit and the inductance correction circuit are designed to operate concurrently in the CC region.

Constant Voltage (CV) Operation

As the FEEDBACK pin approaches 2 V from the constant current regulation mode, the power supply transitions into CV operation. The switching frequency at this point is at its maximum value, corresponding to the peak power point of the CV/CC characteristic. The controller regulates the FEEDBACK pin voltage to remain at FEEDBACK pin threshold (V_{FBTH}) using an ON/OFF state-machine. The FEEDBACK pin voltage is sampled 2.5 μ s after the turn-off of the high-voltage switch. At light loads the current limit is also reduced to decrease the transformer flux density and the FEEDBACK pin sampling is done earlier.

Auto-Restart and Open-Loop Protection

In the event of a fault condition such as an output short or an open-loop condition the LYTSwitch-2 IC enters into an appropriate protection mode.

In the event the FEEDBACK pin voltage during the flyback period falls below 0.7 V before the FEEDBACK pin sampling delay ($\sim 2.5 \mu$ s) for a duration in excess of ~ 450 ms (auto-restart on-time (t_{AR-ON})) the converter enters into auto-restart, wherein the power MOSFET is disabled for 1.2 seconds. The auto-restart alternately enables and disables the switching of the power MOSFET until the fault condition is removed.

In addition to the conditions for auto-restart described above, if the sensed FEEDBACK pin current during the forward period of the conduction cycle (switch "on" time) falls below 120 μ A, the converter annunciates this as an open-loop condition (top resistor in potential divider is open or missing) and reduces the auto-restart time from 450 ms to approximately 6 clock cycles (90 μ s), whilst keeping the disable period of 2 seconds.

Over-Temperature Protection

The thermal shutdown circuitry senses the die temperature. The threshold is set at 142 °C typical with a 60 °C hysteresis. When the die temperature rises above this threshold (142 °C) the power MOSFET is disabled and remains disabled until the die temperature falls by 60 °C, at which point the MOSFET is re-enabled.

Current Limit

The current limit circuit senses the current in the power MOSFET. When this current exceeds the internal threshold (I_{LIMIT}), the power MOSFET is turned off for the remainder of that cycle. The leading edge blanking circuit inhibits the current limit comparator for a short time (t_{LEB}) after the power MOSFET is turned on. This leading edge blanking time has been set so that current spikes caused by capacitance and rectifier reverse recovery time will not cause premature termination of the MOSFET conduction. The LYTSwitch-2 IC also contains a "di/dt" correction feature to minimize CC variation across the input line range.

6 V Regulator

The 6 V regulator charges the bypass capacitor connected to the BYPASS pin to 6 V by drawing a current from the voltage on the DRAIN pin, whenever the MOSFET is off. The BYPASS pin is the internal supply voltage node. When the MOSFET is on, the device runs off of the energy stored in the bypass capacitor. Extremely low power consumption of the internal circuitry allows the LYTSwitch-2 IC to operate continuously from the current drawn from the DRAIN pin. A bypass capacitor value of 1 μ F is sufficient for both high frequency decoupling and energy storage.

A pre-load resistor R10 was employed to discharge the output capacitor and extinguish the LED light immediately after turn-off. The resistor will also keep the output from rising higher than the permitted maximum output voltage (usually determined by the output capacitor voltage rating) when the load is disconnected.

Output Regulation

The LYTSwitch-2 family regulates the output using ON/OFF control in the constant voltage (CV) regulation region of the output characteristic and frequency control for the constant current (CC) region. The feedback resistors (R7 and R8) were selected using standard 1% resistors to center both the nominal output voltage and constant current regulation thresholds. Resistor R6 acts as filter to limit the voltage spike (caused by the coupling of the bias winding to the primary winding), improving regulation.

Key Application Considerations

Output Power Table

The data sheet maximum output power table (Table 1) represents the maximum practical continuous output power that can be obtained under the following assumed conditions:

1. The minimum DC bus voltage is 100 V at 90 VAC input. The value of the input capacitance should be made large enough to meet this requirement for AC input designs – typically 2-3 $\mu\text{F}/\text{W}$ for low-line or universal input designs and 1-2 $\mu\text{F}/\text{W}$ for high-line input designs.
2. The secondary output rectifier diode should withstand peak inverse voltage (PIV) for 55 V output voltage for open load condition.
3. Assume efficiency of >80%.
4. Discontinuous mode operation ($K_p > 1.3$).
5. The LYTSwitch-2 part is either board mounted with SOURCE pins soldered to a sufficient area of copper to keep the SOURCE pin temperature at or below 100 °C, or (in the case of the E package) attached to a sufficiently sized heat sink to limit device temperature to below 110 °C.
6. Ambient temperature of less than 50 °C for open frame designs and an internal enclosure temperature of 60 °C for enclosed ballast-type designs.

Note: Higher output powers are achievable if an output CC tolerance > $\pm 10\%$ is acceptable, and allowing the device to be operated at a higher SOURCE pin temperature.

Output Tolerance

LYTSwitch-2 K and E package parts provides an overall CC mode output current tolerance of $\pm 5\%$ including line voltage, normal board-to-board component variation and across a temperature range of 0 °C to 110 °C. For the D package (SO-8) additional CC variance may occur due to stress caused by manufacturing (i.e. solder-wave immersion or I_R reflow).

A sample power supply build is recommended to verify production tolerances for each design.

BYPASS Pin Capacitor Selection

A 1 μF BYPASS pin capacitor is recommended. The capacitor voltage rating should be greater than 7 V. The capacitor can be ceramic or electrolytic but tolerance of capacitor should be $\leq \pm 50\%$. The capacitor must be physically located close to the LYTSwitch-2 BYPASS pin for effective noise decoupling.

LYTSwitch-2 Layout Considerations

Circuit Board Layout

The LYTSwitch-2 family of ICs present a highly integrated power supply solution that integrates, both, the controller and the high-voltage power MOSFET onto a single die. The presence of high switching currents and voltages together with analog signals makes it especially important to follow good PCB design practice to ensure stable and trouble free operation of the power supply. See Figures 5 and 6 for a recommended circuit board layout for LYTSwitch-2.

When designing a printed circuit board layout for the LYTSwitch-2 based power supply, it is important to follow these guidelines:

Single Point Grounding

Use a single point (Kelvin) connection at the negative terminal of the input filter capacitor for the LYTSwitch-2 SOURCE pin and bias winding return. This improves surge capabilities by returning surge currents from the bias winding directly to the input filter capacitor.

Bypass Capacitor

The BYPASS pin capacitor should be located as close as possible to the SOURCE and BYPASS pins for effective noise decoupling.

Feedback Resistors

Place the feedback resistors (R7 and R8) very close to the FEEDBACK pin of the LYTSwitch-2 device. This minimizes noise coupling.

Thermal Considerations (D and K Package)

The copper area connected to the SOURCE pins provides heat sinking. A good estimate of expected power dissipation is to assume is that the LYTSwitch-2 will dissipate 5% of the output power. Provide enough copper area to keep the SOURCE pin temperature below 100 °C. Higher temperatures are allowable but output current (CC) tolerance will increase. In this case a maximum SOURCE pin temperature below 100 °C is recommended to provide margin for part-to-part $R_{DS(ON)}$ variation.

Secondary Loop Area

To minimize leakage inductance and EMI the area of the loop contained within the connections between the secondary winding (T1), the output diode (D3) and the output filter capacitor (C6) should be minimized. In addition, sufficient copper area should be to the rectifier diode for heat sinking preferably connected to the quiet cathode terminal. A large anode area can increase high frequency radiated EMI.

Electrostatic Discharge Spark Gap

A trace is placed at one of the AC line inputs to form one electrode of a spark gap. The other electrode on the secondary is formed by the output return node. The spark gap directs most ESD energy from the secondary back to the AC input during a surge event. The trace from the AC input to the spark gap electrode should be spaced away from other traces to prevent unwanted arcing occurring and possible circuit damage. If R1 and R2 are removed additional spark gaps across the EMI filter inductors (L1 and L2) to prevent excessive build-up of voltage across them during surge.

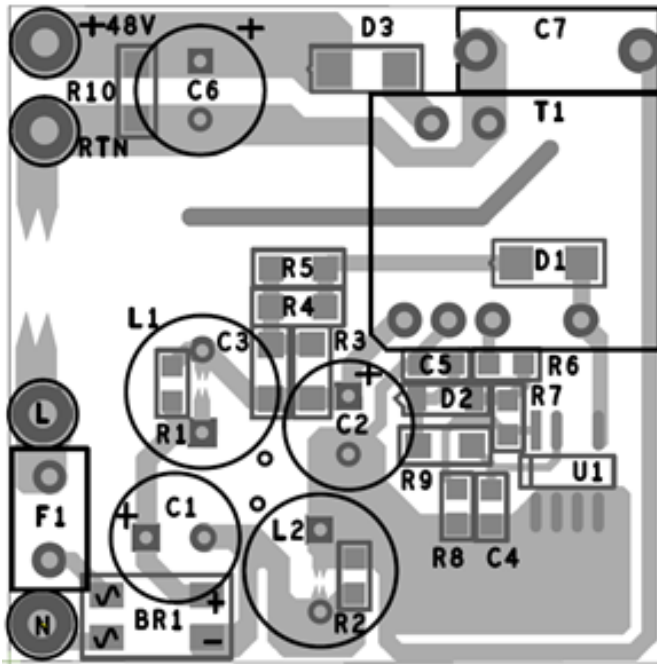

Figure 5. PCB Layout Example using SO-8C Package.

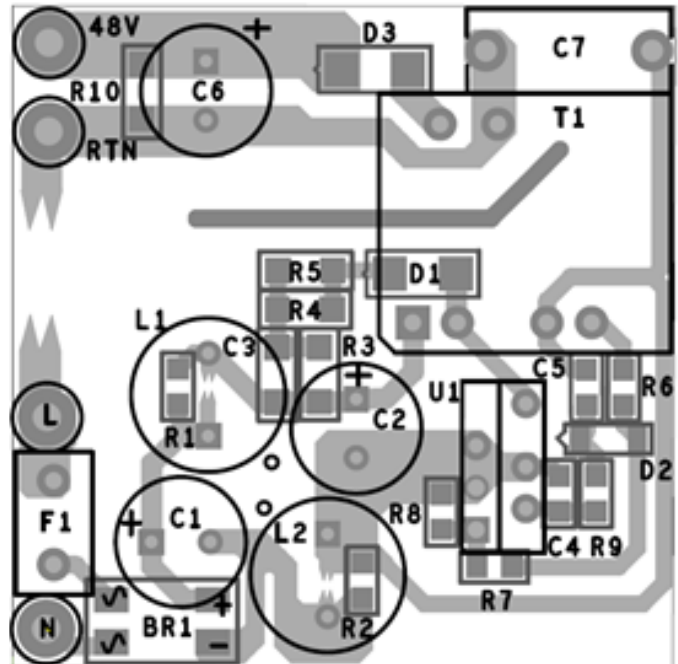

Figure 6. PCB Layout Example using eSIP Package.

Drain Clamp Optimization

LYTSwitch-2 ICs use primary-side sensing to regulate the output. The voltage that appears on the primary winding is a reflection of the secondary winding voltage while the internal is off. Leakage inductance induced ringing can affect output regulation. Optimizing the drain clamp to minimize high frequency ringing will give the best regulation. Figure 7 shows the desired drain voltage waveform; while Figure 8 shows a large undershoot due to a leakage inductance induced ring. Ringing can be reduced (and hence regulation improved) by adjusting the value of the resistor in series with the primary clamp diode.

Addition of a Bias Circuit for Higher Light Load Efficiency and Lower No-load Input Power Consumption

The addition of a bias circuit can decrease the no-load input power from ~200 mW to less than 30 mW at 230 VAC input.

The power supply schematic shown in Figure 4 has the bias circuit incorporated. Diode D2, C5 and R9 form the bias circuit.

Diode D2 rectifies the output and C5 is the filter capacitor. A 1 μ F capacitor is recommended to maintain the minimum bias voltage at low switching frequencies.

The recommended current into the BYPASS pin is equal to IC supply current (~0.5 mA) at the minimum bias winding voltage. The BYPASS pin current should not exceed 3 mA at the maximum bias winding voltage. The value of R9 is calculated according to $(V_{BIAS} - V_{BP}) / I_{S2}$, where V_{BIAS} (10 V typical) is the voltage across C5, I_{S2} (0.5 mA typ.) is the IC supply current and V_{BP} (6.2 V typ.) is the BYPASS pin voltage.

The parameters I_{S2} and V_{BP} are provided in the parameter table of the LYTSwitch-2 data sheet. Diode D2 can be a low-cost type such as FR102, 1N4148 or BAV19/20/21.

Quick Design Checklist

As with any power supply design, all LYTSwitch-2 family designs should be verified on the bench to make sure that component specifications are not exceeded under worst-case conditions. The following set of tests is strongly recommended:

1. Maximum drain voltage – Verify that the peak V_{DS} does not exceed 680 V at the highest input voltage and maximum output power.
2. Drain current – At maximum ambient temperature, maximum and minimum input voltage and maximum output load, review drain current waveforms at start-up for any signs of transformer saturation or excessive leading edge current spikes. LYTSwitch-2 devices have a leading edge blanking time to prevent premature termination of the ON-cycle, but limit leading edge spikes to less than the maximum time as specified in the data sheet.
3. Thermal check – At maximum output power, for both minimum and maximum input voltage and maximum ambient temperature; verify that temperature limits are not exceeded for LYTSwitch-2, transformer, output diodes and output capacitors. Thermal margin should be provided to allow for part-to-part variation in the $R_{DS(ON)}$ of the LYTSwitch-2 device. For optimum regulation, a SOURCE pin temperature of 90 °C is recommended.

Design Tools

Up-to-date information on design tools can be found at the Power Integrations web site: www.power.com

Absolute Maximum Ratings^(1,6)

DRAIN Voltage	-0.3 V to 725 V
DRAIN Pin Peak Current ⁽⁵⁾ : LYT2002	504 (750) mA ⁽²⁾
LYT2003	654 (980) mA ⁽²⁾
LYT2004	686 (1029) mA ⁽²⁾
LYT2005	784 (1176) mA ⁽²⁾
Peak Negative Pulsed Drain Current	-100 mA ⁽³⁾
FEEDBACK Pin Voltage	-0.3 to 9 V
FEEDBACK Pin Current	100 mA
BYPASS Pin Voltage	-0.3 to 9 V
Storage Temperature	-65 to 150 °C
Operating Junction Temperature ⁽⁴⁾	-40 to 150 °C
Lead Temperature ⁽⁵⁾	260 °C

Notes:

1. All voltages referenced to SOURCE, $T_A = 25\text{ °C}$.
2. Higher peak Drain current allowed while Drain to Source voltage does not exceed 400 V.
3. Duration not to exceed 2 ms.
4. Normally limited by internal circuitry.
5. 1/16 in. from case for 5 seconds.
6. Absolute Maximum Ratings specified may be applied, one at a time without causing permanent damage to the product. Exposure to Absolute Maximum Ratings for extended periods of time may affect product reliability.

Thermal Resistance

Thermal Resistance: D Package:

(θ_{JA})	100 °C/W ⁽²⁾ , 80 °C/W ⁽³⁾
(θ_{JC}) ⁽¹⁾	30 °C/W
E Package	
(θ_{JA})	105 °C/W ⁽⁴⁾
(θ_{JC})	2 °C/W ⁽⁵⁾
K Package	
(θ_{JA})	45 °C/W ⁽⁶⁾ , 38 °C/W ⁽⁷⁾
(θ_{JC})	2 °C/W ⁽⁵⁾

Notes:

1. Measured on pin 8 (SOURCE) close to plastic interface.
2. Soldered to 0.36 sq. in. (232 mm²), 2 oz. (610 g/m²) copper clad.
3. Soldered to 1 sq. in. (645 mm²), 2 oz. (610 g/m²) copper clad.
4. Free standing with no heat sink.
5. Measured at the back surface of tab.
6. Soldered (including exposed pad for K package) to typical application PCB with a heat sinking area of 0.36 sq. in. (232 mm²), 2 oz. (610 g/m²) copper clad.
7. Soldered (including exposed pad for K package) to typical application PCB with a heat sinking area of 1 sq. in. (645 mm²), 2 oz. (610 g/m²) copper clad.

Parameter	Symbol	Conditions		Min	Typ	Max	Units
		SOURCE = 0 V; $T_J = 0$ to 100 °C (Unless Otherwise Specified)					
Control Functions							
Programmable Maximum Frequency	f_{OSC}	$T_J = 25\text{ °C}$ $t_{ON} \times I_{FB} = 1.4\text{ mA}\cdot\mu\text{s}$ See Note A	$V_{FB} = V_{FBth}$			85	kHz
Minimum Operation Frequency	$f_{OSC(MIN)}$	$T_J = 25\text{ °C}$ $V_{FB} = V_{FBth}$	LYT2002-2003	300	330	365	Hz
			LYT2004	775	850	930	
			LYT2005	510	580	645	
Frequency Ratio (Constant Current)	$f_{RATIO(CC)}$	$T_J = 25\text{ °C}$ Between $V_{FB} = 1.0\text{ V}$ and $V_{FB} = 1.6\text{ V}$		1.550	1.593	1.635	
Frequency Ratio (Inductance Correction)	$f_{RATIO(IC)}$	Between $t_{ON} \times I_{FB} = 1.4\text{ mA}$ and $t_{ON} \times I_{FB} = 2\text{ mA}\cdot\mu\text{s}$		1.160	1.210	1.260	
Frequency Jitter		Peak-to-Peak Jitter Compared to Average Frequency, $T_J = 25\text{ °C}$			±7		%

Parameter	Symbol	Conditions SOURCE = 0 V; T _J = 0 to 100 °C (Unless Otherwise Specified)		Min	Typ	Max	Units
Control Functions (cont.)							
Maximum Duty Cycle	DC _{MAX}	See Notes D, E			55		%
FEEDBACK Pin Voltage	V _{FB(TH)}	C _{BP} = 1 μF	T _J = 25 °C	1.915	1.940	1.965	V
			T _J = 100 °C See Note E	1.90	1.94	1.98	
FEEDBACK Pin Voltage at Turn-Off Threshold	V _{FB(AR)}			0.69	0.75	0.81	V
Minimum Switch ON-Time	t _{ON(MIN)}	See Note E			700		ns
FEEDBACK Pin Sampling Delay	t _{FB}	T _J = 25 °C		2.35	2.55	2.75	μs
DRAIN Pin Supply Current	I _{S1}	FB Voltage > V _{FBth} (MOSFET Not Switching)			320	370	μA
	I _{S2}	FB Voltage = V _{FBth} -0.1 V, Switch ON-Time = t _{ON} (MOSFET Switching at f _{osc})	LYT2002		500	560	μA
			LYT2003		550	600	
			LYT2004		600	680	
			LYT2005		700	800	
BYPASS Pin Charge Current	I _{CH1}	V _{BP} = 0 V	LYT2002	-7.0	-4.8	-2.5	mA
			LYT2003	-7.2	-5.8	-3.2	
			LYT2004	-8.5	-6.3	-3.2	
			LYT2005	-8.5	-6.3	-3.2	
	I _{CH2}	V _{BP} = 4 V	LYT2002	-5.6	-3.2	-1.4	
			LYT2003	-5.6	-4.0	-2.0	
			LYT2004	-6.0	-4.4	-2.0	
			LYT2005	-6.0	-4.4	-2.0	
BYPASS Pin Voltage	V _{BP}			5.65	5.9	6.25	V
BYPASS Pin Voltage Hysteresis	V _{BPH}			0.70	0.95	1.20	V
BYPASS Pin Shunt Voltage	V _{SHUNT}			6.2	6.4	6.8	V

Parameter	Symbol	Conditions		Min	Typ	Max	Units
		SOURCE = 0 V; T _J = 0 to 100 °C (Unless Otherwise Specified)					
Circuit Protection							
Current Limit	I _{LIMIT}	V _{BP} = 5.9 V T _J = 25 °C	LYT2002D di/dt = 80 mA/μs	293	315	337	mA
			LYT2003D di/dt = 100 mA/μs	363	390	417	
			LYT2004D di/dt = 105 mA/μs	390	420	450	
			LYT2004E/K di/dt = 125 mA/μs	460	495	530	
			LYT2005E/K di/dt = 135 mA/μs	511	550	589	
Minimum Current Limit Scale Factor	I _{LIMIT(MIN)}	T _J = 25 °C		0.28	0.32	0.39	
Normalized Output Current	I _O	T _J = 25 °C		0.975	1.000	1.025	
Leading Edge Blanking Time	t _{LED}	T _J = 25 °C See Note E		170	215		ns
Thermal Shutdown Temperature	T _{SD}	See Note E		135	142	150	°C
Thermal Shutdown Hysteresis	T _{SDH}	See Note E			60		°C
Output							
ON-State Resistance	R _{DS(ON)}	LYT2002D I _D = 63 mA	T _J = 25 °C		13	15.5	Ω
			T _J = 100 °C		20	23.5	
		LYT2003D I _D = 78 mA	T _J = 25 °C		8	9.2	
			T _J = 100 °C		12	14	
		LYT2004D I _D = 84 mA	T _J = 25 °C		5	5.9	
			T _J = 100 °C		7.5	8.60	
		LYT2004E/K I _D = 99 mA	T _J = 25 °C		5	5.9	
			T _J = 100 °C		7.5	8.60	
LYT2005E/K I _D = 110 mA	T _J = 25 °C		3.2	3.8			
	T _J = 100 °C		4.6	5.40			

Parameter	Symbol	Conditions SOURCE = 0 V; $T_j = 0$ to $100\text{ }^\circ\text{C}$ (Unless Otherwise Specified)	Min	Typ	Max	Units
Output (cont.)						
OFF-State Leakage	I_{DSS1}	$V_{DS} = 560\text{ V}$ $T_j = 125\text{ }^\circ\text{C}$, See Note C			50	μA
	I_{DSS2}	$V_{DS} = 375\text{ V}$ $T_j = 50\text{ }^\circ\text{C}$		15		
Breakdown Voltage	BV_{DSS}	$T_j = 25\text{ }^\circ\text{C}$	725			V
DRAIN Pin Supply Voltage			50			V
Auto-Restart ON-Time	t_{AR-ON}	$t_{ON} \times I_{FB} = 1.4\text{ mA}\mu\text{s}$ $f_{OSC} = 12\text{ kHz}$ $V_{FB} = 0$ See Notes A, E	100			ms
Auto-Restart OFF-Time	t_{AR-OFF}	See Note E	0.32			s
Open-Loop FEEDBACK Pin Current Threshold	I_{OL}	See Note E		-45		μA
Open-Loop ON-Time		See Note E		1.4		ms

NOTES:

- Auto-restart on-time is a function of switching frequency programmed by $t_{on} \times I_{FB}$ and minimum frequency in CC mode.
- The current limit threshold is compensated to cancel the effect of current limit delay. As a result the output current stays constant across the input line range.
- I_{DSS1} is the worst-case off-state leakage specification at 80% of BV_{DSS} and maximum operating junction temperature. I_{DSS2} is a typical specification under worst-case application conditions (rectified 265 VAC) for no-load consumption calculations.
- When the duty cycle exceeds DC_{MAX} the LYTSwitch-2 operates in on-time extension mode.
- This parameter is derived from characterization.

Typical Performance Characteristics

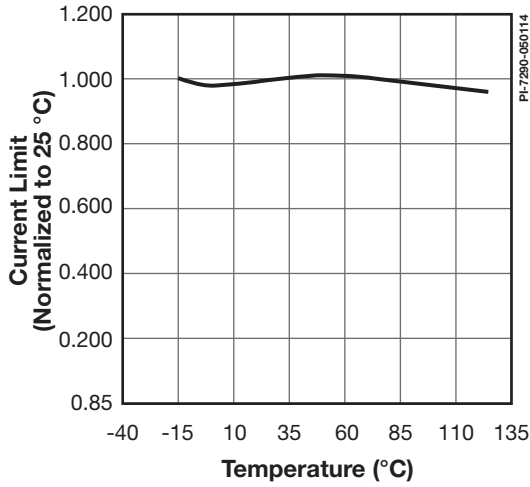

Figure 10. Current Limit vs. Temperature.

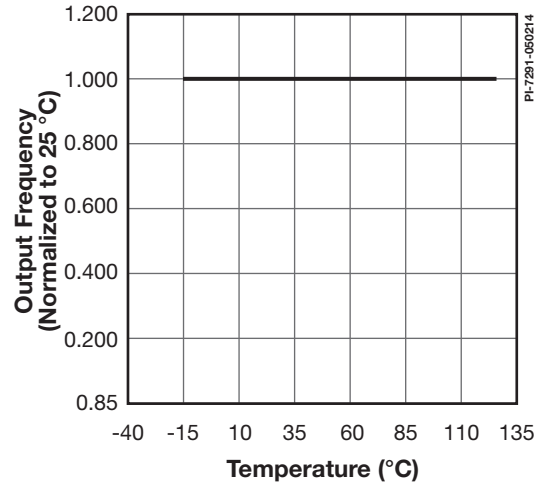

Figure 11. Output Frequency vs. Temperature.

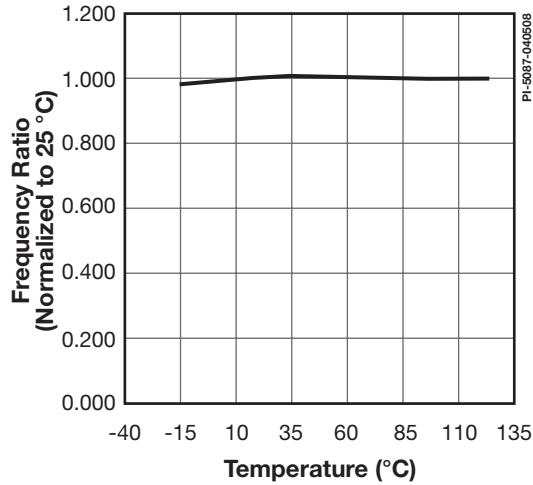

Figure 12. Frequency Ratio vs. Temperature (Constant Current).

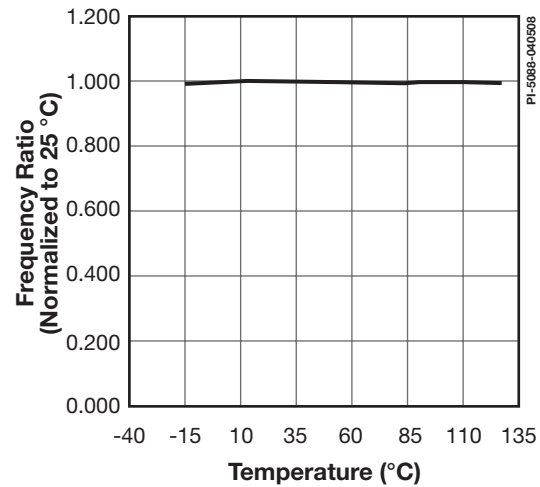

Figure 13. Frequency Ratio vs. Temperature (Inductor Current).

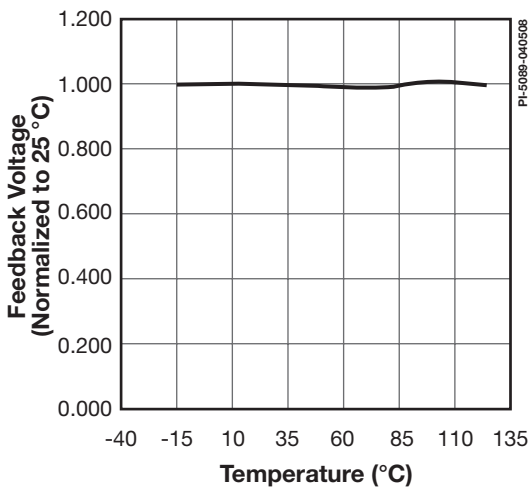

Figure 14. Feedback Voltage vs. Temperature.

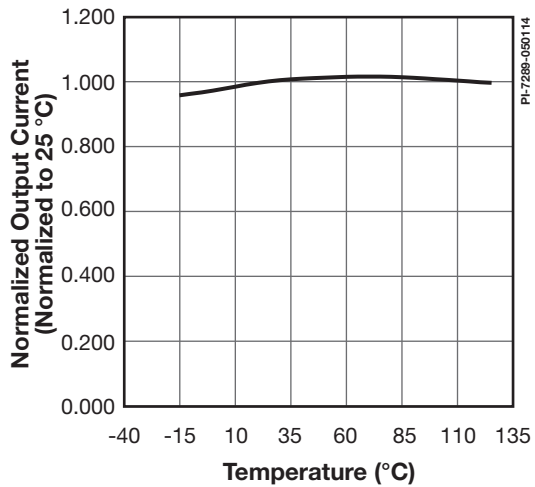

Figure 15. Normalized Output Current vs. Temperature.

Typical Performance Characteristics

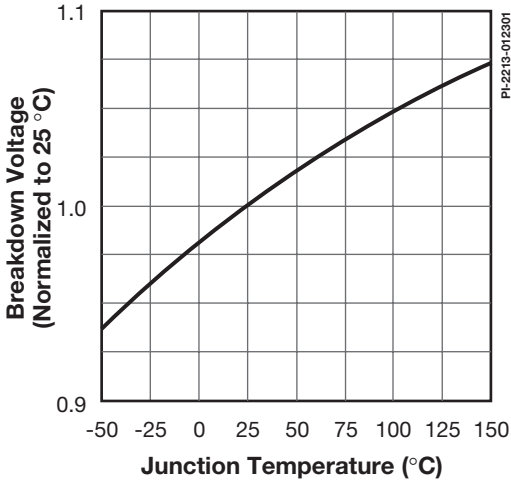

Figure 16. Breakdown vs. Temperature.

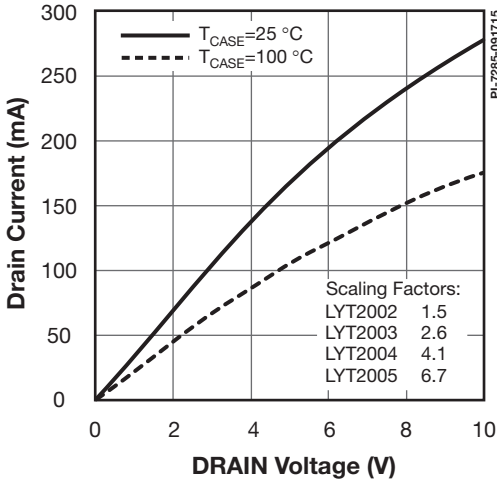

Figure 17. Output Characteristic.

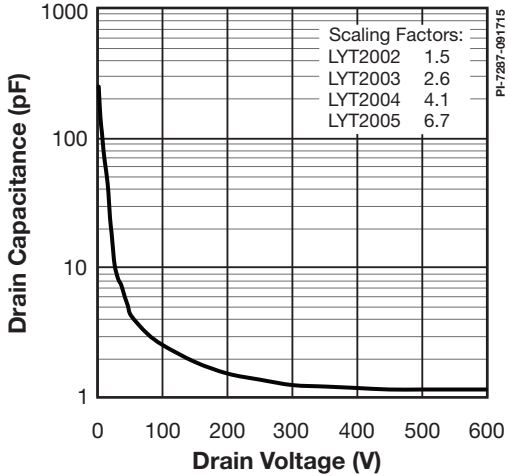

Figure 18. C_{oss} vs. Drain Voltage.

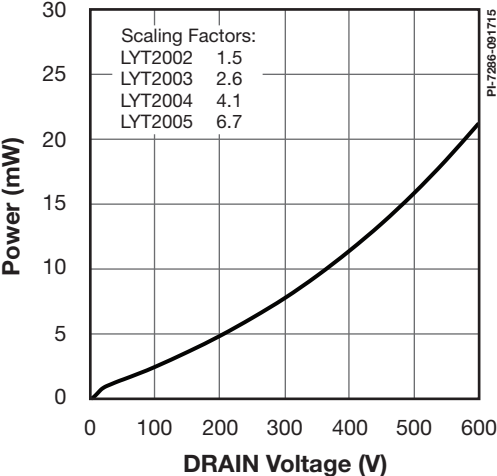
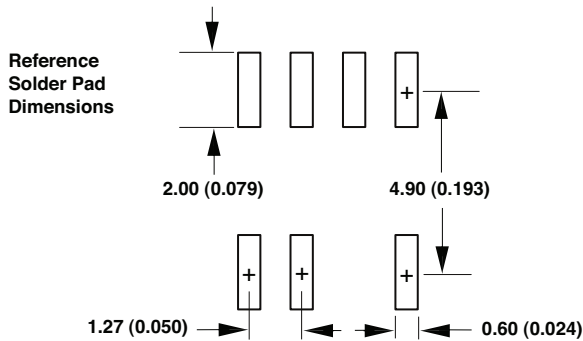
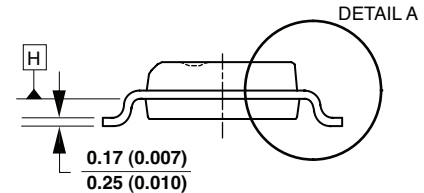
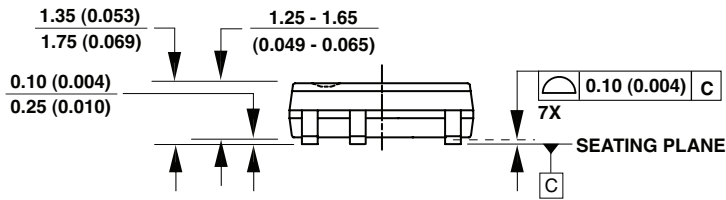
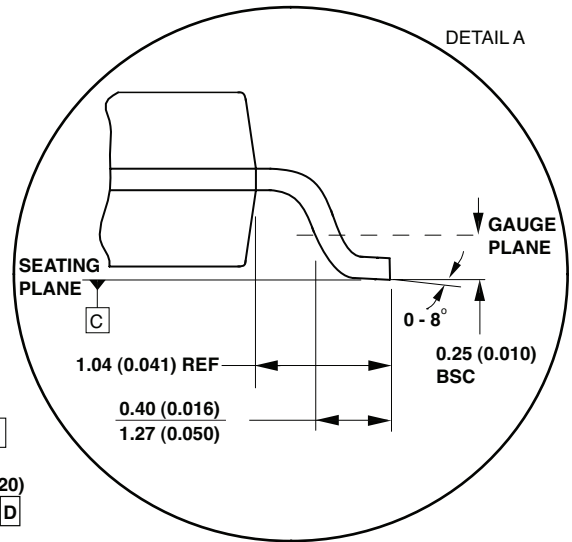
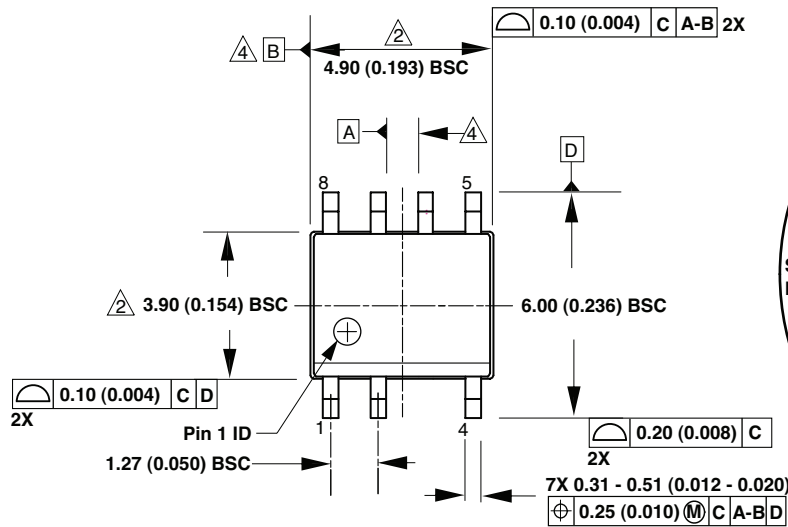

Figure 19. Drain Capacitance Power.

SO-8C (D Package)



- Notes:**
1. JEDEC reference: MS-012.
 2. Package outline exclusive of mold flash and metal burr.
 3. Package outline inclusive of plating thickness.
 4. Datums A and B to be determined at datum plane H.
 5. Controlling dimensions are in millimeters. Inch dimensions are shown in parenthesis. Angles in degrees.

D07C

PI-4526-040110

eSIP-7C (E Package)

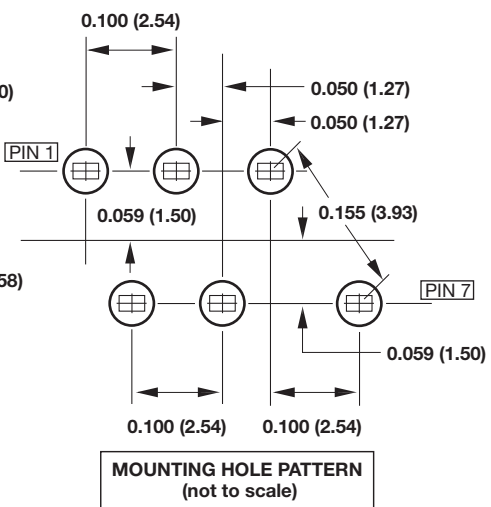
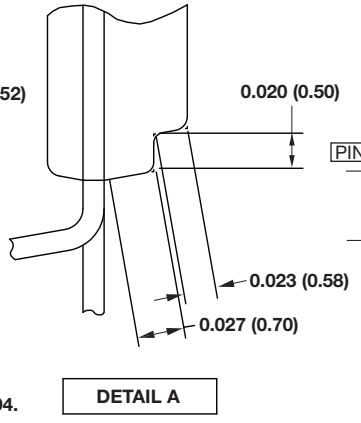
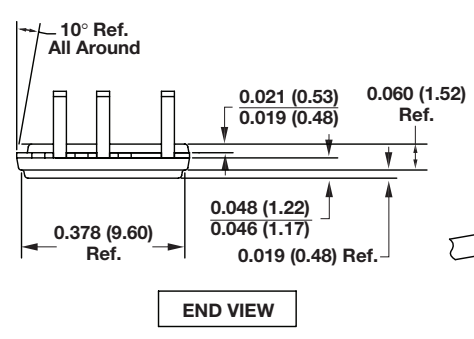
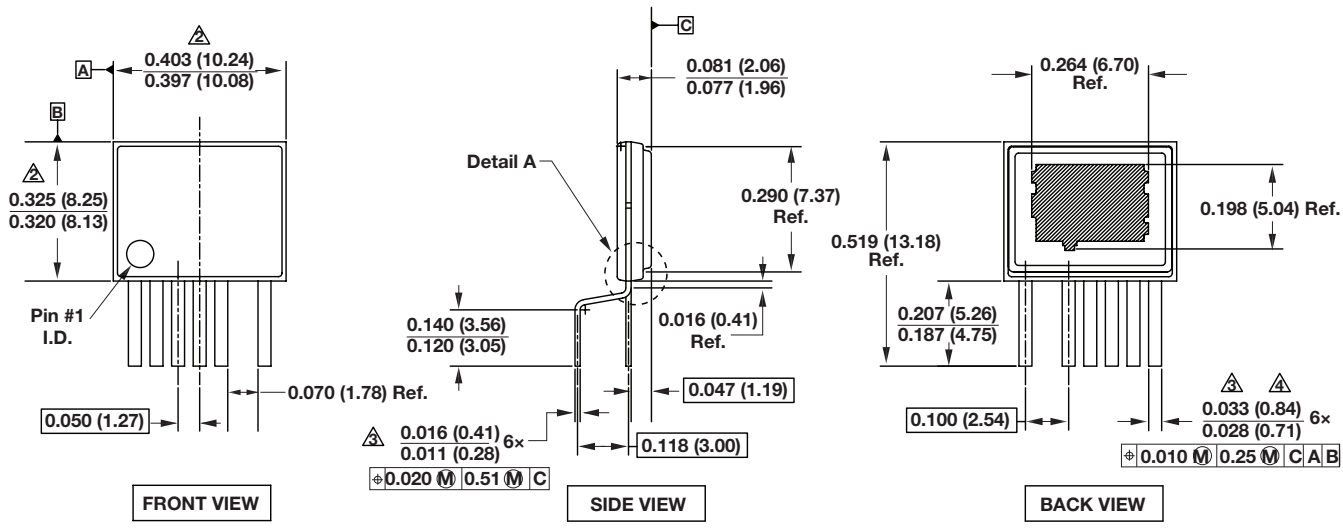

- Notes:
1. Dimensioning and tolerancing per ASME Y14.5M-1994.
 2. Dimensions noted are determined at the outermost extremes of the plastic body exclusive of mold flash, tie bar burrs, gate burrs, and interlead flash, but including any mismatch between the top and bottom of the plastic body. Maximum mold protrusion is 0.007 [0.18] per side.
 3. Dimensions noted are inclusive of plating thickness.
 4. Does not include inter-lead flash or protrusions.
 5. Controlling dimensions in inches (mm).

PI-4917-061510

eSOP-12B (K Package)

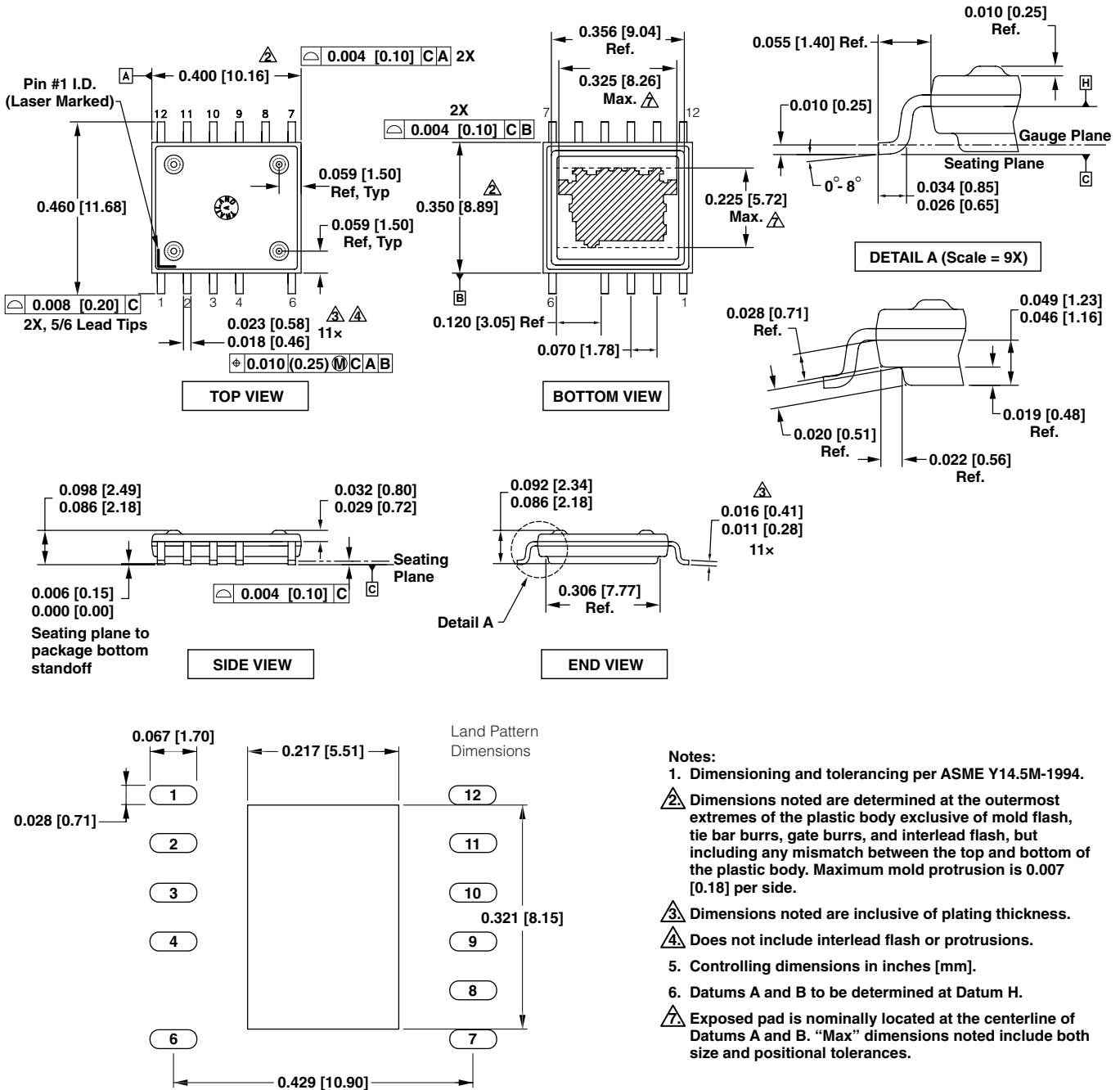

- Notes:**
1. Dimensioning and tolerancing per ASME Y14.5M-1994.
 2. Dimensions noted are determined at the outermost extremes of the plastic body exclusive of mold flash, tie bar burrs, gate burrs, and interlead flash, but including any mismatch between the top and bottom of the plastic body. Maximum mold protrusion is 0.007 [0.18] per side.
 3. Dimensions noted are inclusive of plating thickness.
 4. Does not include interlead flash or protrusions.
 5. Controlling dimensions in inches [mm].
 6. Datums A and B to be determined at Datum H.
 7. Exposed pad is nominally located at the centerline of Datums A and B. "Max" dimensions noted include both size and positional tolerances.

PI-5748a-100311

Part Ordering Information

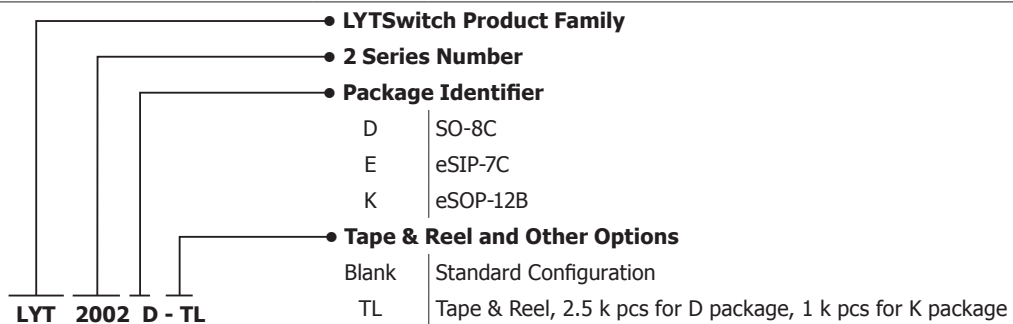

Revision	Notes	Date
A	Code A.	05/19/14
A	Updated Figure 2.	06/12/14
A	Updated $V_{FB(TH)}$ parameter table information.	12/08/14
B	Removed LYT2001D part number from data sheet.	09/15

For the latest updates, visit our website: www.power.com

Power Integrations reserves the right to make changes to its products at any time to improve reliability or manufacturability. Power Integrations does not assume any liability arising from the use of any device or circuit described herein. POWER INTEGRATIONS MAKES NO WARRANTY HEREIN AND SPECIFICALLY DISCLAIMS ALL WARRANTIES INCLUDING, WITHOUT LIMITATION, THE IMPLIED WARRANTIES OF MERCHANTABILITY, FITNESS FOR A PARTICULAR PURPOSE, AND NON-INFRINGEMENT OF THIRD PARTY RIGHTS.

Patent Information

The products and applications illustrated herein (including transformer construction and circuits external to the products) may be covered by one or more U.S. and foreign patents, or potentially by pending U.S. and foreign patent applications assigned to Power Integrations. A complete list of Power Integrations patents may be found at www.power.com. Power Integrations grants its customers a license under certain patent rights as set forth at <http://www.power.com/ip.htm>.

Life Support Policy

POWER INTEGRATIONS PRODUCTS ARE NOT AUTHORIZED FOR USE AS CRITICAL COMPONENTS IN LIFE SUPPORT DEVICES OR SYSTEMS WITHOUT THE EXPRESS WRITTEN APPROVAL OF THE PRESIDENT OF POWER INTEGRATIONS. As used herein:

1. A Life support device or system is one which, (i) is intended for surgical implant into the body, or (ii) supports or sustains life, and (iii) whose failure to perform, when properly used in accordance with instructions for use, can be reasonably expected to result in significant injury or death to the user.
2. A critical component is any component of a life support device or system whose failure to perform can be reasonably expected to cause the failure of the life support device or system, or to affect its safety or effectiveness.

The PI logo, TOPSwitch, TinySwitch, LinkSwitch, LYTSwitch, InnoSwitch, DPA-Switch, PeakSwitch, CAPZero, SENZero, LinkZero, HiperPFS, HiperTFS, HiperLCS, Qspeed, EcoSmart, Clampless, E-Shield, Filterfuse, FluxLink, StakFET, PI Expert and PI FACTS are trademarks of Power Integrations, Inc. Other trademarks are property of their respective companies. ©2015, Power Integrations, Inc.

Power Integrations Worldwide Sales Support Locations

World Headquarters

5245 Hellyer Avenue
San Jose, CA 95138, USA.
Main: +1-408-414-9200
Customer Service:
Phone: +1-408-414-9665
Fax: +1-408-414-9765
e-mail: usasales@power.com

China (Shanghai)

Rm 2410, Charity Plaza, No. 88
North Caoxi Road
Shanghai, PRC 200030
Phone: +86-21-6354-6323
Fax: +86-21-6354-6325
e-mail: chinasales@power.com

China (Shenzhen)

17/F, Hivac Building, No. 2, Keji Nan
8th Road, Nanshan District,
Shenzhen, China, 518057
Phone: +86-755-8672-8689
Fax: +86-755-8672-8690
e-mail: chinasales@power.com

Germany

Lindwurmstrasse 114
80337 Munich
Germany
Phone: +49-895-527-39110
Fax: +49-895-527-39200
e-mail: eurosales@power.com

India

#1, 14th Main Road
Vasanthanagar
Bangalore-560052 India
Phone: +91-80-4113-8020
Fax: +91-80-4113-8023
e-mail: indiasales@power.com

Italy

Via Milanese 20, 3rd. Fl.
20099 Sesto San Giovanni (MI)
Italy
Phone: +39-024-550-8701
Fax: +39-028-928-6009
e-mail: eurosales@power.com

Japan

Kosei Dai-3 Bldg.
2-12-11, Shin-Yokohama,
Kohoku-ku
Yokohama-shi Kanagawa
222-0033 Japan
Phone: +81-45-471-1021
Fax: +81-45-471-3717
e-mail: japansales@power.com

Korea

RM 602, 6FL
Korea City Air Terminal B/D, 159-6
Samsung-Dong, Kangnam-Gu,
Seoul, 135-728, Korea
Phone: +82-2-2016-6610
Fax: +82-2-2016-6630
e-mail: koreasales@power.com

Singapore

51 Newton Road
#19-01/05 Goldhill Plaza
Singapore, 308900
Phone: +65-6358-2160
Fax: +65-6358-2015
e-mail: singaporesales@power.com

Taiwan

5F, No. 318, Nei Hu Rd., Sec. 1
Nei Hu Dist.
Taipei 11493, Taiwan R.O.C.
Phone: +886-2-2659-4570
Fax: +886-2-2659-4550
e-mail: taiwansales@power.com

UK

Cambridge Semiconductor,
a Power Integrations company
Westbrook Centre, Block 5, 2nd Floor
Milton Road
Cambridge CB4 1YG
Phone: +44 (0) 1223-446483
e-mail: eurosales@power.com

Looking for pricing, stock, or lifecycle information?

Click below to explore more details on WIN SOURCE:

 [View LYT2005K-TL on WIN SOURCE](#)

 [Power Integrations](#) Information

Optimize Your Supply Chain with WIN SOURCE Solutions

-  Global Sourcing Solution
-  Obsolete Management
-  Cost Control Management
-  Shortage Management
-  Alternative Solution
-  Excess Inventory Management