



**THE DATASHEET OF
MAX34446ETL+**



MAX34446

PMBus Power-Supply Data Logger

General Description

The MAX34446 data logger for power supplies can monitor voltages for overvoltage and undervoltage, as well as for overcurrent conditions and overtemperature conditions. The device constantly checks for user-programmable thresholds; when these thresholds are exceeded, the device logs the recent real-time operating conditions in nonvolatile flash memory. The device can monitor up to four voltages or currents, and can monitor three temperature sensors. See the [Typical Application Circuit/Block Diagram](#) for more details.

Applications

Base Stations
Industrial Controls
Network Switches/Routers
Servers
Smart Grid Network Systems

[Ordering Information](#) appears at end of data sheet.

[Typical Application Circuit/Block Diagram](#) appears at end of data sheet.

Features

- ◆ Voltage, Current, and Temperature Measurement and Threshold Excursion Detection
- ◆ Supports Up to Four Voltage or Current Measurements
- ◆ Supports Up to Three Temperature Sensors: Two Remote Diodes Plus an Internal Sensor
- ◆ Calculates Power Consumption
- ◆ Differential 12-Bit ADC
- ◆ PMBus™-Compliant Control Interface
- ◆ Power-Good Outputs
- ◆ Individual Fault Outputs
- ◆ On-Board Nonvolatile Fault Logging and Default Configuration Setting
- ◆ I²C/SMBus-Compatible Serial Bus with Bus Timeout Function
- ◆ No External Clocking Required
- ◆ 2.7V to 5.5V Supply Voltage
- ◆ Low Power Consumption
- ◆ -40°C to +105°C Temperature Range
- ◆ 40-Pin TQFN (6mm x 6mm) Package

PMBus is a trademark of SMIF, Inc.

For related parts and recommended products to use with this part, refer to: www.maximintegrated.com/MAX34446.related

For pricing, delivery, and ordering information, please contact Maxim Direct at 1-888-629-4642, or visit Maxim Integrated's website at www.maximintegrated.com.

MAX34446

PMBus Power-Supply Data Logger

ABSOLUTE MAXIMUM RATINGS

V_{DD} to V_{SS}	-0.3V to +5.5V	REG18 to V_{SS}	-0.3V to +2.0V
SDA or SCL to V_{SS}	-0.3V to +5.5V	REG25 to V_{SS}	-0.3V to +0.3V
RS-[5:0] to V_{SS}	-0.3V to +0.3V	Continuous Power Dissipation ($T_A = +70^\circ\text{C}$)	
RS+[5:0] to V_{SS}	-0.3V to ($V_{DD} + 0.3\text{V}$), not to exceed +5.5V	TQFN (derate 35.7mW/ $^\circ\text{C}$ above +70C)	2857.1mW
RS+[5:0] to V_{SS} with 100 Ω of series resistance ..	-0.3V to +2.0V	Operating Temperature Range	-40 $^\circ\text{C}$ to +105 $^\circ\text{C}$
All other pins		Storage Temperature Range	-55 $^\circ\text{C}$ to +125 $^\circ\text{C}$
relative to V_{SS}	-0.3V to ($V_{DD} + 0.3\text{V}$), not to exceed +5.5V	Lead Temperature (soldering, 10s)	+300 $^\circ\text{C}$
All other pins relative to V_{SS} with greater than		Soldering Temperature (reflow)	+260 $^\circ\text{C}$
750 Ω of series resistance	-0.3V to 5.5V		

Stresses beyond those listed under "Absolute Maximum Ratings" may cause permanent damage to the device. These are stress ratings only, and functional operation of the device at these or any other conditions beyond those indicated in the operational sections of the specifications is not implied. Exposure to absolute maximum rating conditions for extended periods may affect device reliability.

RECOMMENDED OPERATING CONDITIONS

($T_A = -40^\circ\text{C}$ to +105 $^\circ\text{C}$, unless otherwise noted.)

PARAMETER	SYMBOL	CONDITIONS	MIN	TYP	MAX	UNITS
V_{DD} Operating Voltage	V_{DD}	(Note 1)	2.7		5.5	V
Input Logic-High	V_{IH}		0.7 x V_{DD}		$V_{DD} + 0.3$	V
Input Logic-Low	V_{IL}		0		0.3 x V_{DD}	V
Input Logic-High: SCL, SDA	V_{I2C_IH}	$2.7\text{V} \leq V_{DD} \leq 3.6\text{V}$ (Note 1)	2.1		$V_{DD} + 0.3$	V
Input Logic-Low: SCL, SDA	V_{I2C_IL}	$2.7\text{V} \leq V_{DD} \leq 3.6\text{V}$ (Note 1)	0		+0.8	V
V_{DD} Rise Time		From 0V to 2.7V			4	ms
V_{DD} Trace Impedance					5	Ω

DC ELECTRICAL CHARACTERISTICS

($V_{DD} = 2.7\text{V}$ to 5.5V, $T_A = -40^\circ\text{C}$ to +105 $^\circ\text{C}$, unless otherwise noted. Typical values are at $V_{DD} = 3.3\text{V}$, $T_A = +25^\circ\text{C}$.)

PARAMETER	SYMBOL	CONDITIONS	MIN	TYP	MAX	UNITS
Supply Current	I_{CPU}	(Note 2)		3.0		mA
	$I_{PROGRAM}$			8		
Brownout Voltage	V_{BO}	Monitors V_{DD} (Note 1)	2.40	2.46	2.55	V
Brownout Hysteresis	V_{BOH}	Monitors V_{DD} (Note 1)		30		mV
Internal System Clock	f_{MOSC}			4.0		MHz
System Clock Error (Note 3)	$f_{ERR:MOSC}$	$+25^\circ\text{C} \leq T_A \leq +85^\circ\text{C}$	-3		+2	%
		$-40^\circ\text{C} \leq T_A \leq +25^\circ\text{C}$	-6.5		+1.6	
		$-20^\circ\text{C} \leq T_A \leq +105^\circ\text{C}$	-4		+2.5	
Output Logic-Low	V_{OL1}	$I_{OL} = 4\text{mA}$ (Note 1)			0.4	V
Output Logic-High	V_{OH1}	$I_{OH} = -2\text{mA}$ (Note 1)	$V_{DD} - 0.5$			V
Pullup Current	I_{PU}	$V_{PIN} = V_{SS}$, $V_{DD} = 3.3\text{V}$	38	55	107	μA

MAX34446

PMBus Power-Supply Data Logger

DC ELECTRICAL CHARACTERISTICS (continued)

($V_{DD} = 2.7V$ to $5.5V$, $T_A = -40^{\circ}C$ to $+105^{\circ}C$, unless otherwise noted. Typical values are at $V_{DD} = 3.3V$, $T_A = +25^{\circ}C$.)

PARAMETER	SYMBOL	CONDITIONS	MIN	TYP	MAX	UNITS
ADC Full-Scale Voltage		$T_A = +25^{\circ}C$	1.22	1.225	1.23	V
ADC Full-Scale Temperature Drift		$T_A = -40^{\circ}C$ to $+105^{\circ}C$	-0.6		+0.6	%
ADC Measurement Resolution	V_{LSB}			300		μV
ADC Bit Resolution			12			Bits
RS+ Input Resistance	R_{IN}		15			$M\Omega$
ADC Integral Nonlinearity	INL	(Note 4)			± 8	LSB
ADC Offset	V_{OFFSET}			± 2		LSB
Internal Temperature Measurement Error		$T_A = -40^{\circ}C$ to $+85^{\circ}C$	-3		+3	$^{\circ}C$
		$T_A = -40^{\circ}C$ to $+105^{\circ}C$	-3.5		+3.5	
Remote Temperature Measurement Error (MAX3446 Error Only)		$T_A = 0^{\circ}C$ to $+60^{\circ}C$, $T_{DIODE} = +60^{\circ}C$ to $+120^{\circ}C$	-1.5		+1.5	$^{\circ}C$
		$T_A = 0^{\circ}C$ to $+60^{\circ}C$, $T_{DIODE} = -45^{\circ}C$ to $+120^{\circ}C$	-1.75		+1.75	
		$T_A = -40^{\circ}C$ to $+105^{\circ}C$, $T_{DIODE} = -45^{\circ}C$ to $+120^{\circ}C$	-3.5		+3.5	
SYNC Frequency Range			20		500	kHz
SYNC Duty Cycle			40	50	60	%
Store Default All Time				37		ms
Nonvolatile Log Write Time				37		ms
Nonvolatile Log Delete Time				775		ms
Nonvolatile Log Overwrite Time				40		ms
Flash Endurance	N_{FLASH}	$T_A = +50^{\circ}C$	20,000			Write Cycles
Data Retention		$T_A = +50^{\circ}C$	100			Years
Current or Voltage Sample Rate				500		μs
Temperature Sample Rate		Per temperature sensor		1000		ms
Device Startup Time		Measurement from POR until monitoring begins		12		ms

MAX3446

PMBus Power-Supply Data Logger

I²C/SMBus INTERFACE ELECTRICAL CHARACTERISTICS

(V_{DD} = 2.7V to 5.5V, T_A = -40°C to +105°C, unless otherwise noted. Typical values are at V_{DD} = 3.3V, T_A = +25°C.)

PARAMETER	SYMBOL	CONDITIONS	MIN	TYP	MAX	UNITS
SCL Clock Frequency	f _{SCL}		10		100	kHz
Bus Free Time Between STOP and START Conditions	t _{BUF}		4.7			μs
Hold Time (Repeated) START Condition	t _{HD:STA}	(Note 5)	4.0			μs
Low Period of SCL	t _{LOW}		4.7			μs
High Period of SCL	t _{HIGH}		4.0			μs
Data Hold Time	t _{HD:DAT}	Receive	0			ns
		Transmit	300			
Data Setup Time	t _{SU:DAT}		100			ns
START Setup Time	t _{SU:STA}		4.7			μs
SDA and SCL Rise Time	t _R				300	ns
SDA and SCL Fall Time	t _F				300	ns
STOP Setup Time	t _{SU:STO}		4.0			μs
Clock Low Timeout	t _{TO}		25		35	ms

Note 1: All voltages are referenced to ground (V_{SS}). Currents entering the device are specified as positive, and currents exiting the device are specified as negative.

Note 2: This does not include pin input/output currents.

Note 3: Guaranteed by design; not production tested.

Note 4: ADC has no missing codes.

Note 5: Commands MFR_MODE, STORE_DEFAULT_ALL, and RESTORE_DEFAULT_ALL require a bus free time of 250ms.

I²C/SMBus Timing

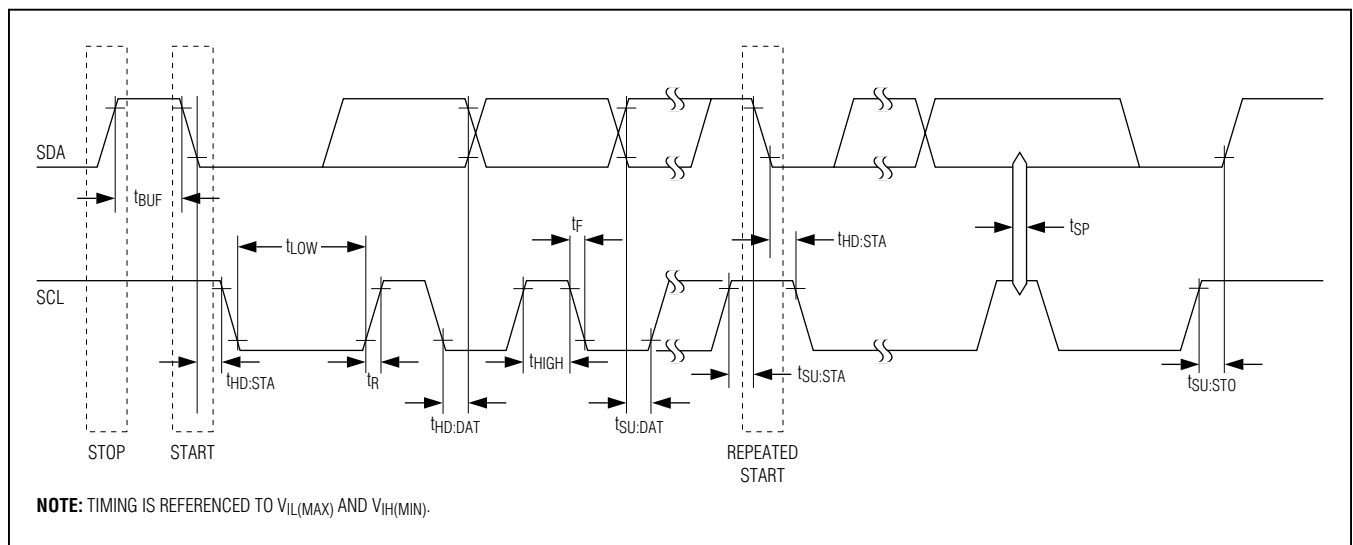

MAX34446

PMBus Power-Supply Data Logger

Typical Operating Characteristics

($V_{DD} = 2.7V$ to $5.5V$, $T_A = -40^{\circ}C$ to $+105^{\circ}C$, unless otherwise noted. Typical values are at $V_{DD} = 3.3V$, $T_A = +25^{\circ}C$.)

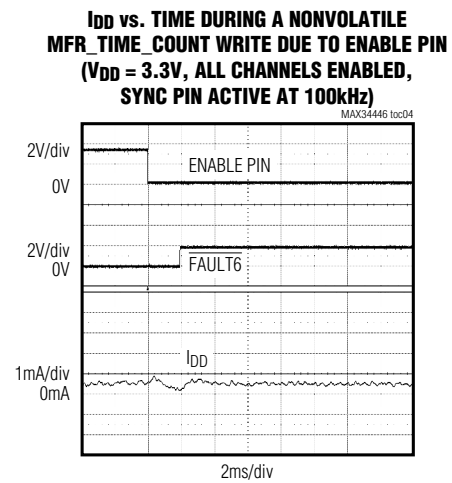
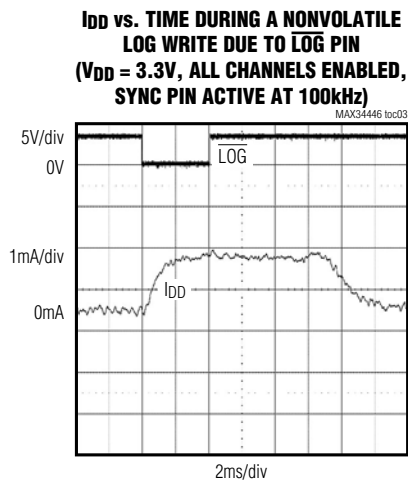
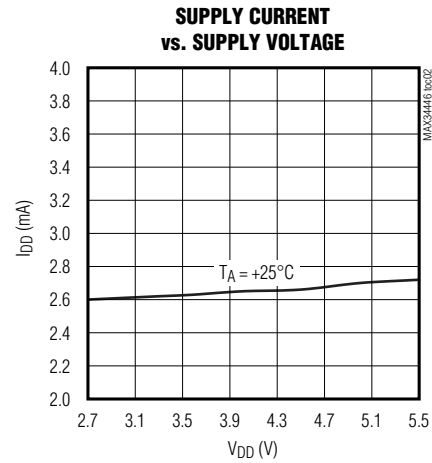
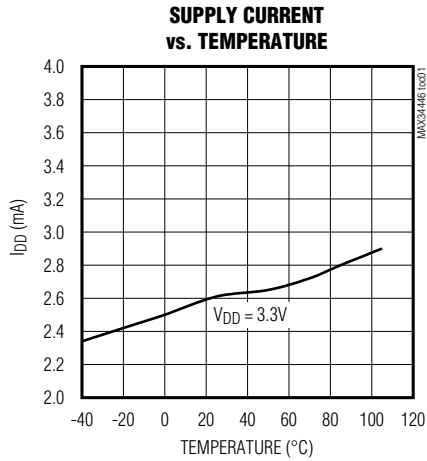

MAX34446

PMBus Power-Supply Data Logger

Pin Configuration

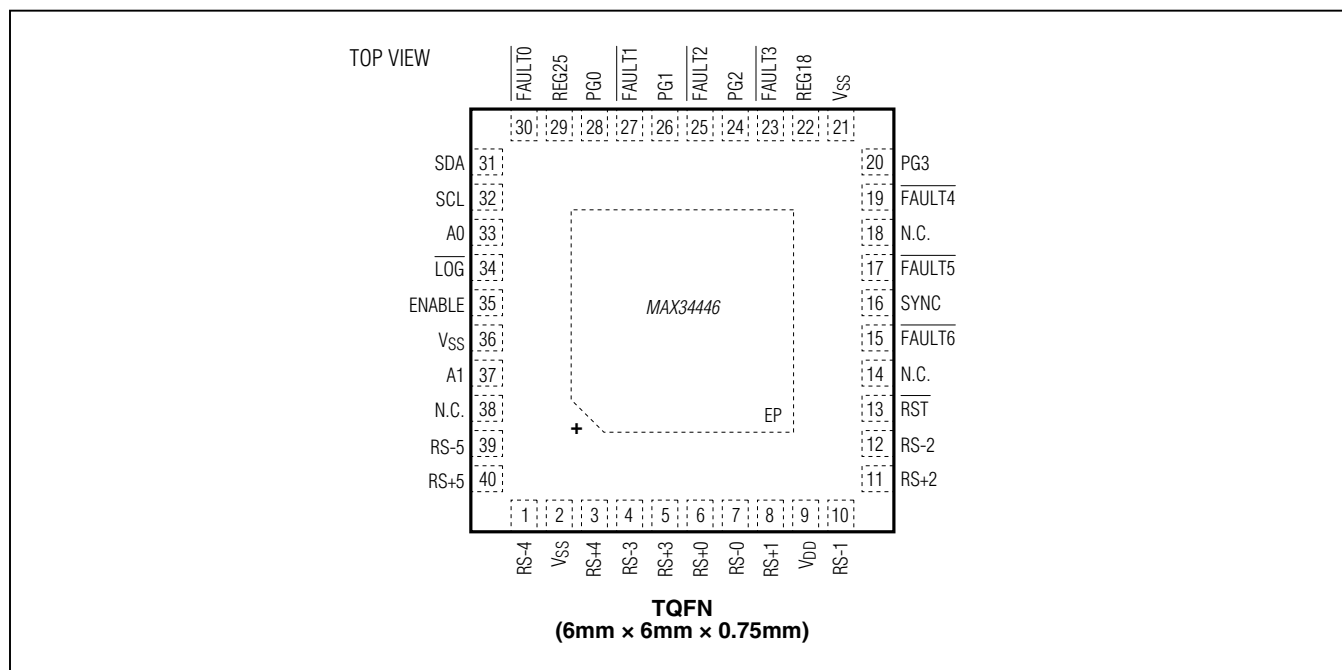

Pin Description

PIN	NAME	FUNCTION
1	RS-4	Ground Reference for ADC4 Remote Thermal Diode Voltage Measurement
2, 21, 36	V _{SS}	Digital-Supply Return Node
3	RS+4	Remote Thermal Diode ADC4 Sense Input, Measurement Relative to RS-4
4	RS-3	Ground Reference for ADC3 Voltage or Current Measurement
5	RS+3	ADC3 Voltage or Current Sense Input, Measurement Relative to RS-3
6	RS+0	ADC0 Voltage or Current Sense Input, Measurement Relative to RS-0
7	RS-0	Ground Reference for ADC0 Voltage or Current Measurement
8	RS+1	ADC1 Voltage or Current Sense Input, Measurement Relative to RS-1
9	V _{DD}	Input Supply Voltage. Bypass V _{DD} to V _{SS} with a 0.1µF capacitor.
10	RS-1	Ground Reference for ADC1 Voltage or Current Measurement
11	RS+2	ADC2 Voltage or Current Sense Input, Measurement Relative to RS-2
12	RS-2	Ground Reference for ADC2 Voltage or Current Measurement
13	$\overline{\text{RST}}$	Active-Low Reset Input/Output
14, 18, 38	N.C.	No Connection. Do not connect any signal to these pins.
15	$\overline{\text{FAULT6}}$	Active-Low, Open-Drain Fault Output for Internal Temperature Sensor

MAX34446

PMBus Power-Supply Data Logger

Pin Description (continued)

PIN	NAME	FUNCTION
16	SYNC	Push-Pull Output Clock. This clock changes between two programmable frequencies based on state of power good. High impedance when disabled and when ENABLE is low.
17	$\overline{\text{FAULT5}}$	Active-Low, Open-Drain Fault Output for Remote Diode Temperature Sensor Connected to ADC5
19	$\overline{\text{FAULT4}}$	Active-Low, Open-Drain Fault Output for Remote Diode Temperature Sensor Connected to ADC4
20	PG3	Power-Good Output for ADC3. Active-high push-pull or open-drain output.
22	REG18	Regulator for Low-Voltage Digital Circuitry. Bypass REG18 to V_{SS} with 1 μ F and 10nF capacitors. Do not connect other circuitry to this pin.
23	$\overline{\text{FAULT3}}$	Active-Low, Open-Drain Fault Output for Voltage or Current Fault on ADC3
24	PG2	Power-Good Output for ADC2. Active-high push-pull or open-drain output.
25	$\overline{\text{FAULT2}}$	Active-Low, Open-Drain Fault Output for Voltage or Current Fault on ADC2
26	PG1	Power-Good Output for ADC1. Active-high push-pull or open-drain output.
27	$\overline{\text{FAULT1}}$	Active-Low, Open-Drain Fault Output for Voltage or Current Fault on ADC1
28	PG0	Power-Good Output for ADC0. Active-high push-pull or open-drain output.
29	REG25	Regulator for Analog Circuitry. Bypass REG25 to V_{SS} with 30 μ F to 47 μ F with an ESR of 0 Ω to 500m Ω . Do not connect other circuitry to this pin.
30	$\overline{\text{FAULT0}}$	Active-Low, Open-Drain Fault Output for Voltage or Current Fault on ADC0
31	SDA	I ² C/SMBus-Compatible Bidirectional Data Line. Open-drain output.
32	SCL	I ² C/SMBus-Compatible Clock
33	A0	I ² C/SMBus Address Select Bit 0
34	$\overline{\text{LOG}}$	Active-Low Force Nonvolatile Logging. Active-low input with an internal 55 μ A pullup. A falling edge on this pin causes the device to log the most recent set of collected data into the nonvolatile memory. This pin has a 100 μ s deglitch filter. Leave open circuit if not needed.
35	ENABLE	Device Enable. Connect to V_{DD} to enable the device. This pin has a 100 μ s deglitch filter. When low, no monitoring or data logging occurs, the PGN outputs are forced low, and the $\overline{\text{FAULTn}}$ outputs are high impedance. On the falling edge of ENABLE, the device attempts to write MFR_TIME_COUNT into nonvolatile memory.
37	A1	I ² C/SMBus Address Select Bit 1
39	RS-5	Ground Reference for ADC5 Remote Thermal Diode Voltage Measurement
40	RS+5	Remote Thermal Diode ADC5 Sense Input, Measurement Relative to RS-5
—	EP	Exposed Pad (Bottom Side of Package). Connect EP to V_{SS} .

Note: All pins except V_{DD} , V_{SS} , REG18, REG25, the ADC pins, and the exposed pad are high impedance with a 55 μ A pullup during device power-up and reset. After device reset, the weak pullup is removed and the pin is configured as an input or output.

PMBus Power-Supply Data Logger

Table 1. PMBus Command Codes

CODE	COMMAND NAME	TYPE	PAGE	PAGE	PAGE	NO. OF BYTES	LOCKED (NOTE 2)	FLASH STORED (NOTE 3)	DEFAULT VALUE (NOTE 3)
			0-3	4, 5, 6	255				
00h	PAGE	R/W Byte	R/W	R/W	R/W	1	N	N	00h
03h	CLEAR_FAULTS	Send Byte	W	W	W	0	Y	N	—
10h	WRITE_PROTECT	R/W Byte	R/W	R/W	R/W	1	Y	N	00h
11h	STORE_DEFAULT_ALL	Send Byte	W	W	W	0	Y	N	—
12h	RESTORE_DEFAULT_ALL	Send Byte	W	W	W	0	Y	N	—
19h	CAPABILITY	Read Byte	R	R	R	1	N	FIXED	00h
20h	VOUT_MODE	Read Byte	R	R	R	1	N	FIXED	40h
2Ah	VOUT_SCALE_MONITOR	R/W Word	R/W	—	—	2	Y	Y	7FFFh
38h	IOUT_CAL_GAIN	R/W Word	R/W	—	—	2	Y	Y	0000h
40h	VOUT_OV_FAULT_LIMIT	R/W Word	R/W	—	—	2	Y	Y	7FFFh
42h	VOUT_OV_WARN_LIMIT	R/W Word	R/W	—	—	2	Y	Y	7FFFh
43h	VOUT_UV_WARN_LIMIT	R/W Word	R/W	—	—	2	Y	Y	0000h
44h	VOUT_UV_FAULT_LIMIT	R/W Word	R/W	—	—	2	Y	Y	0000h
46h	IOUT_OC_WARN_LIMIT	R/W Word	R/W	—	—	2	Y	Y	7FFFh
4Ah	IOUT_OC_FAULT_LIMIT	R/W Word	R/W	—	—	2	Y	Y	0000h
4Fh	OT_FAULT_LIMIT	R/W Word	—	R/W	—	2	Y	Y	0000h
51h	OT_WARN_LIMIT	R/W Word	—	R/W	—	2	Y	Y	7FFFh
5Eh	POWER_GOOD_ON	R/W Word	R/W	—	—	2	Y	Y	0000h
5Fh	POWER_GOOD_OFF	R/W Word	R/W	—	—	2	Y	Y	0000h
78h	STATUS_BYTE	Read Byte	R	R	R	1	N	N	00h
79h	STATUS_WORD	Read Word	R	R	R	2	N	N	0000h
7Ah	STATUS_VOUT	Read Byte	R	—	—	1	N	N	00h
7Eh	STATUS_CML	Read Byte	R	R	R	1	N	N	00h
80h	STATUS_MFR_SPECIFIC	Read Byte	R	R	—	1	N	N	00h
8Bh	READ_VOUT	Read Word	R	—	—	2	N	N	0000h
8Ch	READ_IOUT	Read Word	R	—	—	2	N	N	0000h
8Dh	READ_TEMPERATURE_1	Read Word	—	R	—	2	N	N	0000h
96h	READ_POUT	Read Word	R	—	—	2	N	N	0000h
98h	PMBUS_REVISION	Read Byte	R	R	R	1	N	FIXED	11h
99h	MFR_ID	Read Byte	R	R	R	1	N	FIXED	4Dh
9Ah	MFR_MODEL	Read Byte	R	R	R	1	N	FIXED	54h
9Bh	MFR_REVISION	Read Word	R	R	R	2	N	FIXED	(Note 4)
9Ch	MFR_LOCATION	Block R/W	R/W	R/W	R/W	8	Y	Y	(Note 5)
9Dh	MFR_DATE	Block R/W	R/W	R/W	R/W	8	Y	Y	(Note 5)
9Eh	MFR_SERIAL	Block R/W	R/W	R/W	R/W	8	Y	Y	(Note 5)
D1h	MFR_MODE	R/W Word	R/W	R/W	R/W	2	Y	Y	0000h
D4h	MFR_VOUT_PEAK	R/W Word	R/W	—	—	2	Y	N	0000h
D5h	MFR_IOUT_PEAK	R/W Word	R/W	—	—	2	Y	N	0000h
D6h	MFR_TEMPERATURE_PEAK	R/W Word	—	R/W	—	2	Y	N	8000h

PMBus Power-Supply Data Logger

Table 1. PMBus Command Codes (continued)

CODE	COMMAND NAME	TYPE	PAGE	PAGE	PAGE	NO. OF BYTES	LOCKED (NOTE 2)	FLASH STORED (NOTE 3)	DEFAULT VALUE (NOTE 3)
			0-3	4, 5, 6	255				
D7h	MFR_VOUT_MIN	R/W Word	R/W	—	—	2	Y	N	7FFFh
D9h	MFR_FAULT_RESPONSE	R/W Byte	R/W	R/W	—	1	Y	Y	00h
DAh	MFR_FAULT_RETRY	R/W Word	R/W	R/W	—	2	Y	Y	0000h
DBh	MFR_PG_DELAY	R/W Word	R/W	—	—	2	Y	Y	0000h
DCh	MFR_NV_FAULT_LOG	Block Read	R	R	R	255	Y	Y	(Note 6)
DDh	MFR_TIME_COUNT	Block Read	R/W	R/W	R/W	4	Y	Y	(Note 7)
E0h	MFR_POOUT_PEAK	R/W Word	R/W	—	—	2	Y	N	0000h
E1h	MFR_POOUT_AVG	R/W Word	R/W	—	—	2	Y	N	0000h
E2h	MFR_IOUT_AVG	R/W Word	R/W	—	—	2	Y	N	0000h
E3h	MFR_TEMPERATURE_AVG	R/W Word	—	R/W	—	2	Y	N	0000h
EFh	MFR_SYNC_CONFIG	R/W Word	R/W	R/W	R/W	2	Y	Y	0000h

Note 1: Common commands are shaded. Access through any page results in the same device response.

Note 2: If the device is locked, only the commands listed with “N” can be read. All other commands return FFh if read. Only the PAGE and MFR_SERIAL commands can be written to. The device unlocks if the upper 4 bytes of MFR_SERIAL match the data written to the device.

Note 3: In the **Flash Stored** column, an “N” indicates that this parameter is not stored in flash memory when the STORE_DEFAULT_ALL command is executed and the value shown in the **Default Value** column is automatically loaded upon power-on reset or when the RST pin is asserted. A “Y” in the **Flash Stored** column indicates that the currently loaded value in this parameter is stored in flash memory when the STORE_DEFAULT_All command is executed and is automatically loaded upon power-on reset or when the RST pin is asserted and the value shown in the **Default Value** column is the value when shipped from the factory. “FIXED” in the **Flash Stored** column means this value is fixed at the factory as a ROM value and cannot be changed.

Note 4: The factory-set default value that contains the device revision numbers.

Note 5: The factory-set default value for this 8-byte block is 3130313031303130h.

Note 6: The factory-set default value for the complete block of the MFR_NV_FAULT_LOG is FFh.

Note 7: The factory-set default value for the complete block is 00h.

Detailed Description

The MAX34446 data logger for power supplies can monitor voltages for overvoltage and undervoltage, as well as for overcurrent conditions and overtemperature conditions. The device constantly checks for user-programmable thresholds; when these thresholds are

exceeded, the device logs the recent real-time operating conditions in nonvolatile flash memory. The device can monitor up to four voltages or currents, and can monitor three temperature sensors. See the [Typical Application Circuit/Block Diagram](#) for more details.

PMBus Power-Supply Data Logger

Table 2. PMBus/SMBus Serial-Port Address

A1	A0	7-BIT SLAVE ADDRESS
100kΩ to V _{SS}	100kΩ to V _{SS}	0010 010 (24h)
	100kΩ to V _{DD}	0010 011 (26h)
100kΩ to V _{DD}	100kΩ to V _{SS}	0010 100 (28h)
	100kΩ to V _{DD}	0010 101 (2Ah)

Address Select

On device power-up or reset, the device samples the A0 and A1 pins to determine the PMBus/SMBus serial-port address. See [Table 2](#).

SMBus/PMBus Operation

The device implements the PMBus command structure using the SMBus format. The structure of the data flow between the host and the slave is shown below for several different types of transactions. Data is sent most significant bit (MSB) first.

SMBus/PMBus Communication Examples

READ WORD FORMAT

1	7	1	1	8	1	1	7	1	1	8	1	8	1	1
S	SLAVE ADDRESS	W	A	COMMAND CODE	A	Sr	SLAVE ADDRESS	R	A	DATA BYTE LOW	A	DATA BYTE HIGH	NA	P

READ BYTE FORMAT

1	7	1	1	8	1	1	7	1	1	8	1	1
S	SLAVE ADDRESS	W	A	COMMAND CODE	A	Sr	SLAVE ADDRESS	R	A	DATA BYTE	NA	P

WRITE WORD FORMAT

1	7	1	1	8	1	8	1	8	1	1
S	SLAVE ADDRESS	W	A	COMMAND CODE	A	DATA BYTE LOW	A	DATA BYTE HIGH	A	P

WRITE BYTE FORMAT

1	7	1	1	8	1	8	1	1
S	SLAVE ADDRESS	W	A	COMMAND CODE	A	DATA BYTE	A	P

SEND BYTE FORMAT

1	7	1	1	8	1	1
S	SLAVE ADDRESS	W	A	COMMAND CODE	A	P

KEY:

- S = START
- Sr = REPEATED START
- P = STOP
- W = WRITE BIT (0)
- R = READ BIT (1)
- A = ACKNOWLEDGE (0)
- NA = NOT ACKNOWLEDGE (1)
- SHADED BLOCK = SLAVE TRANSACTION

PMBus Power-Supply Data Logger

Group Command

The device supports the group command. With the group command, a host can write different data to multiple devices on the same serial bus with one long continuous

data stream. All the devices addressed during this transaction wait for the host to issue a STOP before beginning to respond to the command.

Group Command Write Format

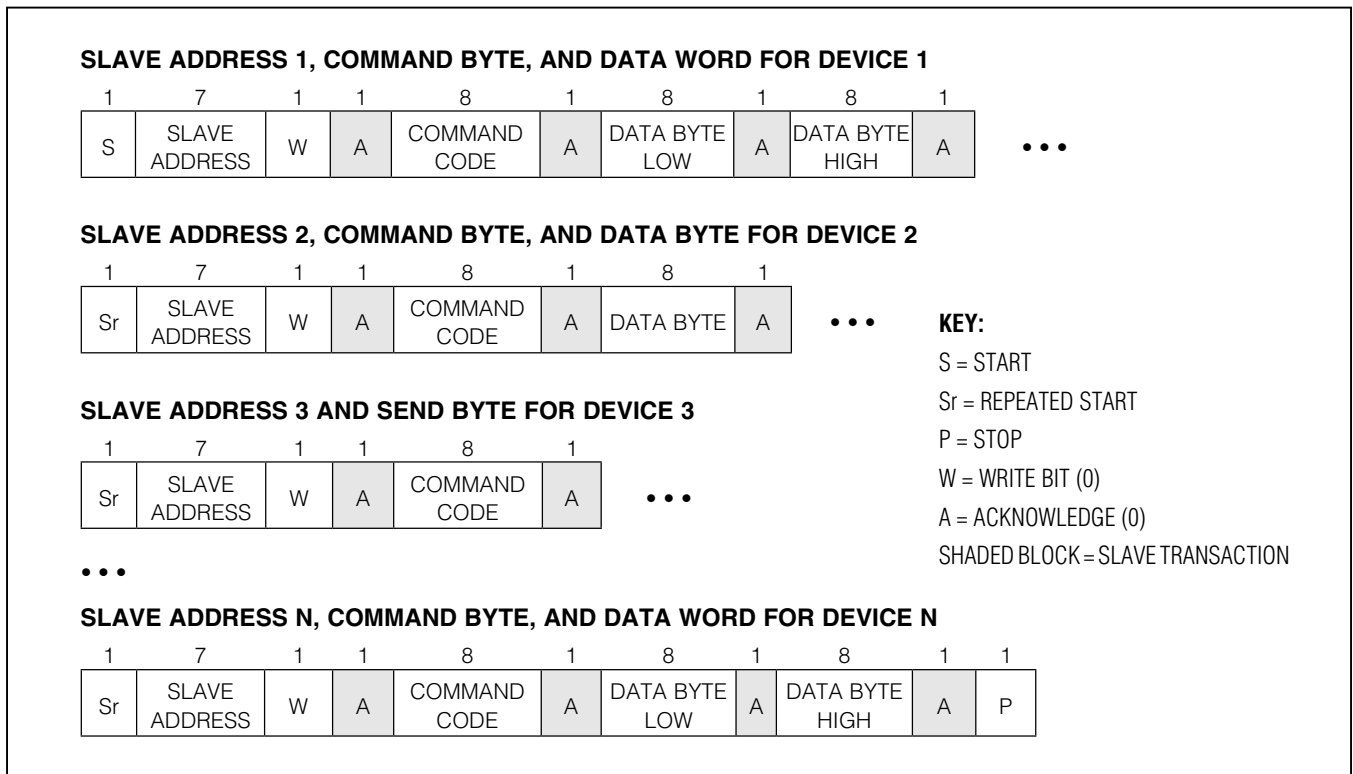

Addressing

The device responds to receiving its fixed slave address by asserting an acknowledge (ACK) on the bus. The device does not respond to a general call address; it only responds when it receives its fixed slave address.

Host Sends or Reads Too Few Bits

If for any reason the host does not complete writing a full byte or reading a full byte from the device before a START or STOP is received, the device does the following:

- 1) Ignores the command.
- 2) Sets the CML bit in STATUS_BYTE.

- 3) Sets the CML bit in STATUS_WORD.
- 4) Sets the DATA_FAULT bit in STATUS_CML.

Host Sends or Reads Too Few Bytes

For each supported command, the device expects a fixed number of bytes to be written or read from the device. If for any reason fewer than the expected number of bytes is written to or read from the device, the device completely ignores the command and takes no action.

Host Sends Too Many Bytes or Bits

For each supported command, the device expects a fixed number of bytes to be written to the device. If for

PMBus Power-Supply Data Logger

any reason more than the expected number of bytes or bits is written to the device, the device does the following:

- 1) Ignores the command.
- 2) Sets the CML bit in STATUS_BYTE.
- 3) Sets the CML bit in STATUS_WORD.
- 4) Sets the DATA_FAULT bit in STATUS_CML.

Host Reads Too Many Bytes or Bits

For each supported command, the device expects a fixed number of bytes to be read from the device. If for any reason more than the expected number of bytes or bits is read from the device, the device does the following:

- 1) Sends all ones (FFh) as long as the host keeps acknowledging.
- 2) Sets the CML bit in STATUS_BYTE.
- 3) Sets the CML bit in STATUS_WORD.
- 4) Sets the DATA_FAULT bit in STATUS_CML.

Host Sends Improperly Set Read Bit in the Slave Address Byte

If the device receives the R/W bit in the slave address set to one immediately preceding the command code, the device does the following:

- 1) ACKs the address byte.
- 2) Sends all ones (FFh) as long as the host keeps acknowledging.
- 3) Sets the CML bit in STATUS_BYTE.
- 4) Sets the CML bit in STATUS_WORD.
- 5) Sets the DATA_FAULT bit in STATUS_CML.

Unsupported Command Code Received

If the host sends the device a command code that it does not support, or if the host sends a command code that is not supported by the current PAGE setting, the device does the following:

- 1) Ignores the command.
- 2) Sets the CML bit in STATUS_BYTE.
- 3) Sets the CML bit in STATUS_WORD.
- 4) Sets the COMM_FAULT bit in STATUS_CML.

Invalid Data Received

The device checks the PAGE and WRITE_PROTECT command codes for valid data. If the host writes a data value that is invalid, the device does the following:

- 1) Ignores the command.

- 2) Sets the CML bit in STATUS_BYTE.
- 3) Sets the CML bit in STATUS_WORD.
- 4) Sets the DATA_FAULT bit in STATUS_CML.

Host Reads from a Write-Only Command

When a read request is issued to a write-only command (CLEAR_FAULTS, STORE_DEFAULT_ALL, and RESTORE_DEFAULT_ALL), the device does the following:

- 1) ACKs the address byte.
- 2) Ignores the command.
- 3) Sends all ones (FFh) as long as the host keeps acknowledging.
- 4) Sets the CML bit in STATUS_BYTE.
- 5) Sets the CML bit in STATUS_WORD.
- 6) Sets the DATA_FAULT bit in STATUS_CML.

Host Writes to a Read-Only Command

When a write request is issued to a read-only command, the device does the following:

- 1) Ignores the command.
- 2) Sets the CML bit in STATUS_BYTE.
- 3) Sets the CML bit in STATUS_WORD.
- 4) Sets the COMM_FAULT bit in STATUS_CML.

SMBus Timeout

If during an active SMBus communication sequence the SCL signal is held low for greater than the timeout duration (t_{TO}), the device terminates the sequence and resets the serial bus. It takes no other action. No status bits are set.

PMBus Operation

From a software perspective, the device appears as a PMBus device capable of executing a subset of PMBus commands. A PMBus 1.1-compliant device uses the SMBus version 1.1 for transport protocol and responds to the SMBus slave address. In this data sheet, the term SMBus is used to refer to the electrical characteristics of the PMBus communication using the SMBus physical layer. The term PMBus is used to refer to the PMBus command protocol. The device employs a number of standard SMBus protocols to program voltage warning/faults thresholds, read monitored data, and provide access to all manufacturer-specific commands.

The device supports the group command. The group command is used to send commands to more than one PMBus device. It is not required that all the devices

PMBus Power-Supply Data Logger

receive the same command. However, no more than one command can be sent to any one device in one group command packet. The group command must not be used with commands that require receiving devices to respond with data, such as the STATUS_BYTE command. When the device receives a command through this protocol, it immediately begins execution of the received command after detecting the STOP condition.

The device supports the PAGE command and uses it to select which individual channel to access. When a data word is transmitted, the lower order byte is sent first and the higher order byte is sent last. Within any byte, the most significant bit (MSB) is sent first and the least significant bit (LSB) is sent last.

PMBus Protocol Support

The device supports a subset of the commands defined in the *PMBus Power System Management Protocol Specification Part II - Command Language, Revision 1.1*. For detailed specifications and the complete list of

PMBus commands, refer to Part II of the PMBus specification available at www.PMBus.org. The supported PMBus commands and the corresponding device behavior are described in this document. All data values are represented in DIRECT format, unless otherwise stated. Whenever the PMBus specification refers to the PMBus device, it is referring to the MAX34446. While the command can call for turning on or turning off the PMBus device, the MAX34446 always remains on to continue communicating with the PMBus master.

Data Format

Voltage data for commanding or reading the output voltage or related parameters (such as the overvoltage threshold) is presented in DIRECT format. DIRECT format data is a 2-byte, two's complement binary value. DIRECT format data can be used with any command that sends or reads a parametric value. The DIRECT format uses an equation and defined coefficients to calculate the desired values. [Table 3](#) shows the coefficients used by the device.

Table 3. PMBus Command Code Coefficients

PARAMETER	COMMANDS	UNITS	RESOLUTION	MAX	m	b	R
Voltage	VOUT_OV_FAULT_LIMIT VOUT_UV_FAULT_LIMIT POWER_GOOD_ON POWER_GOOD_OFF READ_VOUT MFR_VOUT_PEAK MFR_VOUT_MIN	mV	1	32,767	1	0	0
Voltage Scaling	VOUT_SCALE_MONITOR	—	1/32,767	1	32,767	0	0
Current	IOUT_OC_FAULT_LIMIT READ_IOUT MFR_IOUT_PEAK MFR_IOUT_AVG	mA	1	32,767	1	0	0
Current Scaling	IOUT_CAL_GAIN	mΩ	0.1	3276.7	1	0	1
Temperature	OT_FAULT_LIMIT READ_TEMPERATURE_1 MFR_TEMPERATURE_PEAK MFR_TEMPERATURE_AVG	°C	0.01	327.67	1	0	2
Timing	MFR_FAULT_RETRY MFR_PG_DELAY	ms	1	32,767	1	0	0
Power	READ_POUT MFR_POUT_PEAK MFR_POUT_AVG	W	1	32,767	1	0	0

PMBus Power-Supply Data Logger

Interpreting Received DIRECT Format Values

The host system uses the following equation to convert the value received from the PMBus device—in this case, the MAX34446—into a reading of volts, degrees Celsius, or other units as appropriate:

$$X = (1/m) \times (Y \times 10^{-R} - b)$$

where X is the calculated, real world value in the appropriate units (V, °C, etc.); m is the slope coefficient; Y is the 2-byte, two's complement integer received from the PMBus device; b is the offset; and R is the exponent.

Sending a DIRECT Format Value

To send a value, the host must use the below equation to solve for Y:

$$Y = (mX + b) \times 10^R$$

where Y is the 2-byte, two's complement integer to be sent to the unit; m is the slope coefficient; X is the real world value, in units such as volts, to be converted for transmission; b is the offset; and R is the exponent.

The following example demonstrates how the host can send and retrieve values from the device.

If the host received a value of 0D89h on a READ_VOUT command, this is equivalent to:

$$X = (1/1) \times (0D89h \times 10^{(-0)} - 0) = 3465mV = 3.465V$$

with READ_VOUT (8Bh) coefficients m = 1, b = 0, and R = 0 (see [Table 3](#)).

All voltage-related parameters of PMBus devices are reported as positive values. It is up to the system to know that a particular output is negative if that is of interest to the system. All output voltage-related commands use 2 data bytes.

Fault Management and Reporting

Faults are reported in the various status registers and, if enabled with the MFR_FAULT_RESPONSE command, faults can also be indicated on the associated FAULTn output. See the individual command sections for more details.

Faults and warnings that are latched in the status registers are cleared when any one of the following conditions occurs:

- A CLEAR_FAULTS command is received.
- The \overline{RST} pin is toggled low.
- Bias power to the device is removed and then reapplied.

The device responds to fault conditions according to the manufacturer fault response command (MFR_FAULT_RESPONSE). This command byte determines how the device should respond to each particular fault.

Password Protection

The device can be password protected by using the LOCK bit in the MFR_MODE command. Once the device is locked, only certain PMBus commands can be accessed with the serial port. See [Table 1](#) for a complete list. Commands that have password protection return all ones (FFh) with the proper number of data bytes when read. When the device is locked, only the PAGE and MFR_SERIAL commands can be written; all other commands that are written are ignored. When MFR_SERIAL is written and the upper 4 bytes match the internally flash-stored value, the device unlocks and remains unlocked until the LOCK bit in MFR_MODE is activated once again. The LOCKED status bit in STATUS_MFR_SPECIFIC is always available to indicate whether the device is locked or unlocked.

PMBus Power-Supply Data Logger

Voltage/Current Monitoring

ADC inputs 0 to 3 can be independently configured to monitor either voltage or current. The device defaults to monitoring voltage on the ADC0 to ADC3 inputs, but if the IOUT_OC_FAULT_LIMIT command is configured with a positive nonzero value, the device instead monitors current on the associated ADC input. When an ADC input is configured to monitor voltage, all current related commands (like READ_IOUT) are invalid on the associated page and, likewise when an ADC input is configured to monitor current, all voltage-related commands are invalid and the PGN outputs are forced high impedance.

Power Calculation

The device can be configured to calculate power consumption. The READ_POUT, MFR_POUT_PEAK, and MFR_POUT_AVG commands only contain valid data when the device is configured as shown below. The device can calculate power on up to two power nodes by using 4 channels of the ADC: two for voltage measurement and two for current measurement. To measure power, ADC0 and ADC1 must be coupled together and ADC2 and ADC3 must be coupled together. Since the PMBus page alignment is assigned based on the ADC input, power is reported in both pages of the associated coupled voltage/current pair.

Power Measurement 1 (Page 0 or 1)	ADC0 = Voltage Measurement (Page 0)
	ADC1 = Current Measurement (Page 1)
Power Measurement 2 (Page 2 or 3)	ADC2 = Voltage Measurement (Page 2)
	ADC3 = Current Measurement (Page 3)

Temperature Sensor Operation

The device can monitor up to three different temperature sensors, two external remote diode temperature sensors plus its own internal temperature sensor. The device defaults to having the temperature sensors disabled, but if the OT_FAULT_LIMIT command is configured with a positive nonzero value, the temperature sensor is enabled on the associated page. The device reads one of the enabled temperature sensors once per second. Hence, if only one temperature sensor is enabled, it is read every second. If all three temperature sensors are enabled, each sensor is read once every 3 seconds.

Each time the device attempts to read a temperature sensor, it checks for faults. For the remote diode, a fault is defined as a reading greater than +160°C or less than -60°C. For the internal temperature sensor, a fault is defined as a reading greater than +130°C or less than -60°C. Temperature sensor faults are reported by setting the temperature reading to 7FFFh. A temperature sensor fault results in the setting of the TEMPERATURE bit in STATUS_BYTE and STATUS_WORD. No bits are set in STATUS_MFR_SPECIFIC.

The remote diode temperature sensor can support either npn or pnp transistors. The device automatically cancels the series resistance that can affect remote diodes that are located far from the device.

PMBus Power-Supply Data Logger

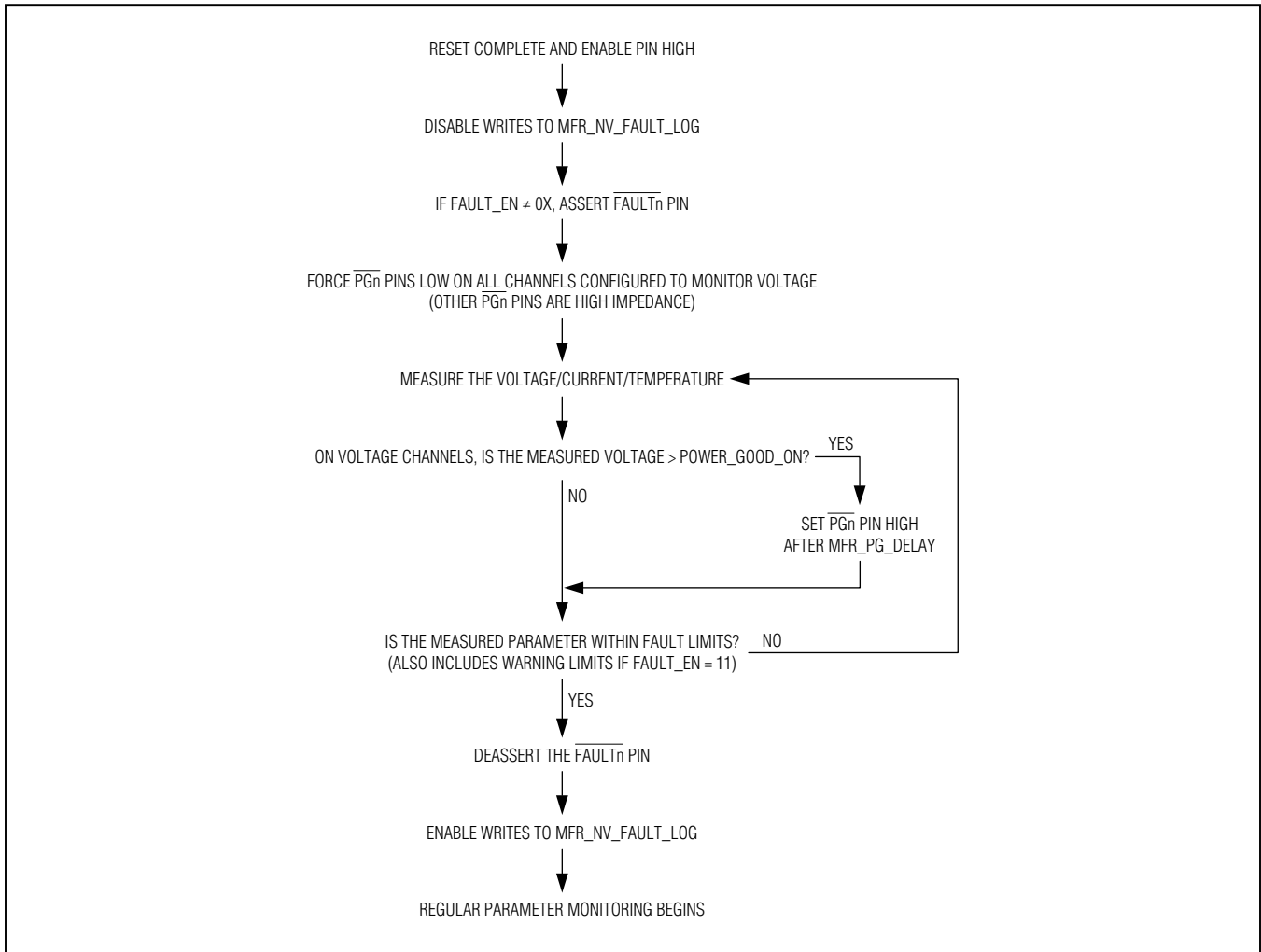

Figure 1. PGn and FAULTn Output After a Channel is Enabled

Fault Response When a Channel is Enabled

Whenever a channel (voltage, current, or temperature) is enabled (V_{DD} cycle, or hardware or software reset, or by PMBus command) the channel's FAULTn signal is asserted if the FAULT_EN bits in MFR_FAULT_RESPONSE are set so that the device responds to a fault or warning. If enabled, the FAULTn pin is not released until all measurements pass. Also, prior to being allowed to set

a fault/warning status bit or write a nonvolatile fault log when a fault/warning occurs, the channel must first pass this particular fault or warning.

Figure 1 describes the steps that the MAX34446 takes to monitor a channel after the channel is enabled. Figure 2 explains how the MAX34446 responds after a channel is enabled and as faults and warnings pass and fail. Figure 2 shows a voltage channel and over-voltage faults and warnings, but these same steps apply to other monitored parameters as well.

PMBus Power-Supply Data Logger

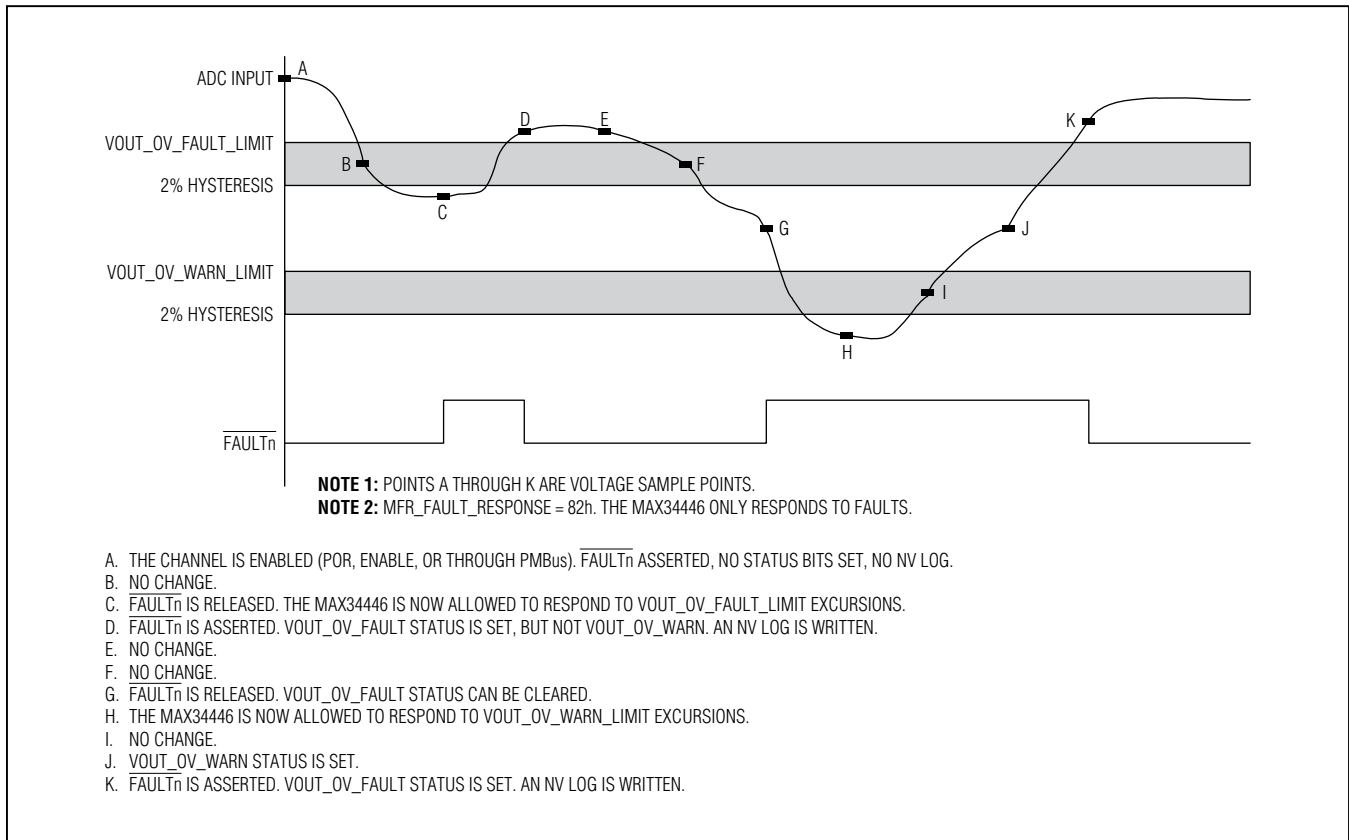

Figure 2. Fault Response After a Channel is Enabled

System Watchdog Timer

The device uses an internal watchdog timer that is internally reset every 500 μ s. In the event that the device is locked up and this watchdog reset does not occur after 500ms, the device automatically resets. After the reset occurs, the device reloads all configuration values that

were stored to flash and begins normal operation. After the reset, the device also does the following:

- 1) Sets the NONE OF THE ABOVE bit in STATUS_BYTE.
- 2) Sets the NONE OF THE ABOVE and MFR bits in STATUS_WORD.
- 3) Sets the WATCHDOG bit in STATUS_MFR_SPECIFIC.

MAX34446

PMBus Power-Supply Data Logger

PMBus Commands

A summary of the PMBus commands supported by the device is described in the following sections.

PAGE (00h)

The device can monitor up to four remote voltages or currents: up to two remote diode temperature sensors, and an internal temperature sensor using one PMBus (I²C) address. Send the PAGE command with data 0 to 6 to select which voltage or current or temperature sensor is affected by all the following PMBus commands. Not all commands are supported within each page. If an unsupported command is received, the CML status bit is set. Some commands are common, meaning that any selected page has the same effect on and the same response from the device.

Set the PAGE to 255 when it is desired that the PMBus commands in [Table 1](#) should apply to all pages at the same time.

Table 4. PAGE Commands

PAGE (DEC)	ASSOCIATED CONTROL
0	Remote Voltage-Divider or Current-Sense Amplifier Connected to ADC0
1	Remote Voltage-Divider or Current-Sense Amplifier Connected to ADC1
2	Remote Voltage-Divider or Current-Sense Amplifier Connected to ADC2
3	Remote Voltage-Divider or Current-Sense Amplifier Connected to ADC3
4	Remote Diode Temperature Sensor Connected to ADC4
5	Remote Diode Temperature Sensor Connected to ADC5
6	Internal Temperature Sensor
7 to 254	Reserved
255	Applies to All Pages

MAX34446

PMBus Power-Supply Data Logger

CLEAR_FAULTS (03h)

The CLEAR_FAULTS command is used to clear any latched status bits that have been set. This command clears all bits simultaneously. If the fault/warning is still present after the CLEAR_FAULTS command is executed, the status bit is set again. This command is write-only. There is no data byte for this command.

WRITE_PROTECT (10h)

The WRITE_PROTECT command is used to provide protection against accidental changes to the device's operating memory. All supported commands can have their parameters read, regardless of the WRITE_PROTECT settings. [Table 5](#) describes the WRITE_PROTECT message content.

Table 5. WRITE_PROTECT Command Byte

COMMAND BYTE	MEANING
80h	Disable all writes except the WRITE_PROTECT command.
40h	Disable all writes except the WRITE_PROTECT and PAGE commands.
00h	Enable writes for all commands (default).

Note: No fault or error is generated if the host attempts to write to a protected area.

STORE_DEFAULT_ALL (11h)

The STORE_DEFAULT_ALL command instructs the device to transfer the device configuration information to the internal flash memory array. Not all information is stored. Only configuration data is stored, not any status, or operational data. If an error occurs during the transfer, the CML bit is set to 1. The device is unresponsive to PMBus commands while transferring the configuration. This command is write-only. There is no data byte for this command. After this command is sent, another command should not be sent for at least 250ms.

RESTORE_DEFAULT_ALL (12h)

The RESTORE_DEFAULT_ALL command transfers the default configuration information from the internal flash memory array to the user memory registers in the device. Upon a device power-on reset or device reset through the \overline{RST} input pin, this command is automatically executed by the device without PMBus action required. This command is write-only. There is no data byte for this command. There is no data byte for this command. After this command is sent, another command should not be sent for at least 250ms.

CAPABILITY (19h)

The CAPABILITY command is used to determine some key capabilities of the device. The CAPABILITY command is read-only. [Table 6](#) describes the message content.

Table 6. CAPABILITY Command Byte

BIT	DESCRIPTION	MEANING
7	Packet-Error Checking	0 = PEC not supported.
6:5	PMBus Speed	00 = Maximum supported bus speed is 100kHz.
4	ALERT	0 = Device does not support ALERT output.
3:0	Reserved	Always returns 0000.

MAX34446

PMBus Power-Supply Data Logger

VOUT_MODE (20h)

The VOUT_MODE command is used to report the device's data format. The device uses the DIRECT format for all the voltage-related commands. The value returned is 40h, indicating DIRECT data format. This command is read-only. If a host attempts to write this command, the CML status bit is asserted. See [Table 3](#) for the m, b, and R values for the various commands.

VOUT_SCALE_MONITOR (2Ah)

VOUT_SCALE_MONITOR is used in applications where the measured power-supply voltage is not equal to the voltage at the ADC input. For example, if the ADC input expects a 1.0V input for a 12V output, VOUT_SCALE_MONITOR = 1.0V/12V = 0.0833. In applications where the power-supply voltage is greater than the device's input range, the voltage of the power supply is sensed through a resistive voltage-divider. The resistive voltage-divider reduces or scales the output voltage. The PMBus commands specify the actual power-supply voltages and not the input voltage to the ADC. To allow the device to map between the power-supply voltage (such as 12V) and the voltage at the ADC input, the VOUT_SCALE_MONITOR command is used. The 2 data bytes are in DIRECT format. This value is dimensionless. For example, if the required scaling factor is 0.0833, then VOUT_SCALE_MONITOR should be set to 0AABh (2731/32,767 = 0.0833). See [Table 7](#).

USER NOTE: The device's full-scale ADC voltage is 1.225V. A scaling factor where a 1.0V ADC input represents a nominal 100% voltage level is recommended.

Table 7. VOUT_SCALE_MONITOR

NOMINAL VOLTAGE LEVEL MONITORED (V)	NOMINAL ADC INPUT VOLTAGE LEVEL (V) (SEE USER NOTE)	RESISTIVE VOLTAGE-DIVIDER RATIO	VOUT_SCALE_MONITOR VALUE (HEX)
1.2	1.0	0.833	6AAAh
1.5	1.0	0.667	5555h
1.8	1.0	0.555	470Ah
2.5	1.0	0.4	3333h
3.3	1.0	0.303	26C8h
5	1.0	0.2	1999h
12	1.0	0.0833	0AABh

IOUT_CAL_GAIN (38h)

The IOUT_CAL_GAIN command is used to set the ratio of the voltage at the ADC input to the sensed current. The units of the IOUT_CAL_GAIN factor are 0.1mΩ. The 2 data bytes are in DIRECT format. For example, if a 10mΩ sense resistor is used in conjunction with a 50V/V current sense amplifier, the IOUT_CAL_GAIN should be set to 500mΩ or 1388h.

USER NOTE: The device's full-scale ADC voltage is 1.225V. The value of the sense resistor and current sense amplifier gain must be scaled appropriately.

VOUT_OV_FAULT_LIMIT (40h)

The VOUT_OV_FAULT_LIMIT command sets the value of the output voltage that causes an output overvoltage fault. The monitored voltage must drop by at least 2% below the limit before the fault is allowed to clear. This fault is masked until the output voltage is below this limit for the first time. The 2 data bytes are in DIRECT format. In response to the VOUT_OV_FAULT_LIMIT being exceeded, the device does the following:

- 1) Sets the VOUT_OV bit in STATUS_BYTE.
- 2) Sets the VOUT_OV and VOUT bits in STATUS_WORD.
- 3) Sets the VOUT_OV_FAULT bit in STATUS_VOUT.
- 4) Responds as specified in the MFR_FAULT_RESPONSE.

PMBus Power-Supply Data Logger

VOUT_OV_WARN_LIMIT (42h)

The VOUT_OV_WARN_LIMIT command sets the value of the output voltage that causes an output voltage high warning. The monitored voltage must drop by at least 2% below the limit before the warning is allowed to clear. This warning is masked until the output voltage is below this limit for the first time. The 2 data bytes are in DIRECT format. In response to the VOUT_OV_WARN_LIMIT being exceeded, the device does the following:

- 1) Sets the NONE OF THE ABOVE bit in STATUS_BYTE.
- 2) Sets the NONE OF THE ABOVE and VOUT bits in STATUS_WORD.
- 3) Sets the VOUT_OV_WARN bit in STATUS_VOUT.
- 4) Responds as specified in the MFR_FAULT_RESPONSE.

VOUT_UV_WARN_LIMIT (43h)

The VOUT_UV_WARN_LIMIT command sets the value of the output voltage that causes an output undervoltage warning. The monitored voltage must increase by at least 2% above the limit before the warning is allowed to clear. This warning is masked until the output voltage exceeds this limit for the first time. The 2 data bytes are in DIRECT format. In response to the VOUT_UV_WARN_LIMIT being exceeded, the device does the following:

- 1) Sets the NONE OF THE ABOVE bit in STATUS_BYTE.
- 2) Sets the NONE OF THE ABOVE and VOUT bits in STATUS_WORD.
- 3) Sets the VOUT_UV_WARN bit in STATUS_VOUT.
- 4) Responds as specified in the MFR_FAULT_RESPONSE.

VOUT_UV_FAULT_LIMIT (44h)

The VOUT_UV_FAULT_LIMIT command sets the value of the output voltage that causes an output undervoltage fault. The monitored voltage must increase by at least 2% above the limit before the fault is allowed to clear. This fault is masked until the output voltage exceeds this limit for the first time. The 2 data bytes are in DIRECT format. In response to violation of the VOUT_UV_FAULT_LIMIT, the device does the following:

- 1) Sets the NONE OF THE ABOVE bit in STATUS_BYTE.
- 2) Sets the NONE OF THE ABOVE and VOUT bits in STATUS_WORD.
- 3) Sets the VOUT_UV_FAULT bit in STATUS_VOUT.
- 4) Responds as specified in the MFR_FAULT_RESPONSE.

IOUT_OC_WARN_LIMIT (46h)

The IOUT_OC_WARN_LIMIT command sets the value of the current that causes an overcurrent warning. The monitored current must drop by at least 5% below the limit before the warning is allowed to clear. This warning is masked until the current is below this limit for the first time. The 2 data bytes are in DIRECT format. In response to violation of the IOUT_OC_WARN_LIMIT, the device does the following:

- 1) Sets the NONE OF THE ABOVE bit in STATUS_BYTE.
- 2) Sets the NONE OF THE ABOVE and MFR bits in STATUS_WORD.
- 3) Sets the OC_WARN bit in STATUS_MFR_SPECIFIC.
- 4) Responds as specified in the MFR_FAULT_RESPONSE.

PMBus Power-Supply Data Logger

IOUT_OC_FAULT_LIMIT (4Ah)

The IOUT_OC_FAULT_LIMIT command sets the value of the current that causes an overcurrent fault. The monitored current must drop by at least 5% below the limit before the fault is allowed to clear. This fault is masked until the current is below this limit for the first time. The 2 data bytes are in DIRECT format. In response to violation of the IOUT_OC_FAULT_LIMIT, the device does the following:

- 1) Sets the IOUT_OC bit in STATUS_BYTE.
- 2) Sets the IOUT_OC and MFR bits in STATUS_WORD.
- 3) Sets the OC_FAULT bit in STATUS_MFR_SPECIFIC.
- 4) Responds as specified in the MFR_FAULT_RESPONSE.

The factory default value for IOUT_OC_FAULT_LIMIT is 0000h. This value disables the device from measuring current and instead selects voltage monitoring on this channel (if the channel is enabled with the MFR_MODE command). Any nonzero positive value written to IOUT_OC_FAULT_LIMIT causes the device to enable current measurement instead of voltage measurement. See [Table 8](#).

Table 8. IOUT_OC_FAULT_LIMIT

IOUT_OC_FAULT_LIMIT VALUE	DEVICE RESPONSE (ON THE ASSOCIATED PAGE)
8000h to FFFFh	Negative values are invalid.
0000h	Current measurement disabled (voltage measurement enabled).
0001h to 7FFFh	Current measurement enabled (voltage measurement disabled).

OT_FAULT_LIMIT (4Fh)

The OT_FAULT_LIMIT command sets the temperature, in degrees Celsius, of the selected temperature sensor at which an overtemperature fault is detected. The monitored temperature must drop by at least 4°C below the limit before the fault is allowed to clear. This fault is masked until the temperature is below this limit for the first time. The 2 data bytes are in DIRECT format. In response to the OT_FAULT_LIMIT being exceeded, the device does the following:

- 1) Sets the TEMPERATURE bit in STATUS_BYTE.
- 2) Sets the TEMPERATURE and MFR bits in STATUS_WORD.
- 3) Sets the OT_FAULT bit in STATUS_MFR_SPECIFIC register.
- 4) Responds as specified in the MFR_FAULT_RESPONSE.

The factory default value for OT_FAULT_LIMIT is 0000h. This value disables the device from measuring temperature on the selected temperature sensor. Any nonzero positive value written to OT_FAULT_LIMIT causes the device to enable temperature measurement.

Table 9. OT_FAULT_LIMIT

OT_FAULT_LIMIT VALUE	DEVICE RESPONSE (ON THE ASSOCIATED PAGE)
8000h to FFFFh	Negative values are invalid.
0000h	Temperature measurement disabled.
0001h to 7FFFh	Temperature measurement enabled.

PMBus Power-Supply Data Logger

OT_WARN_LIMIT (51h)

The OT_WARN_LIMIT command sets the temperature, in degrees Celsius, of the selected temperature sensor at which an overtemperature warning is detected. The monitored temperature must drop by at least 4°C below the limit before the warning is allowed to clear. This warning is masked until the temperature is below this limit for the first time. The 2 data bytes are in DIRECT format. In response to the OT_WARN_LIMIT being exceeded, the device does the following:

- 1) Sets the TEMPERATURE bit in STATUS_BYTE.
- 2) Sets the TEMPERATURE and MFR bits in STATUS_WORD.
- 3) Sets the OT_WARN bit in STATUS_MFR_SPECIFIC register.
- 4) Responds as specified in the MFR_FAULT_RESPONSE.

POWER_GOOD_ON (5Eh)

The POWER_GOOD_ON command sets the value of the monitored voltage that causes the PG[3:0] outputs to assert. The monitored voltage must be above the associated POWER_GOOD_ON threshold before the associated PGn output is asserted and the POWER_GOOD# bit in the associated STATUS_MFR_SPECIFIC is cleared (Figure 3). The assertion of the PGn outputs can be delayed with the MFR_PG_DELAY command. All individual voltage channels must exceed POWER_GOOD_ON before the POWER_GOOD# bit in the STATUS_WORD is cleared. The POWER_GOOD_ON level is normally set higher than the POWER_GOOD_OFF level. The 2 data bytes are in DIRECT format. This command is ignored if the channel is disabled or configured to monitor current.

POWER_GOOD_OFF (5Fh)

The POWER_GOOD_OFF command sets the value of the monitored voltage that causes the PG[3:0] outputs to deassert after it has been asserted. A monitored voltage that falls below the associated POWER_GOOD_OFF threshold causes the associated PGn output to be deasserted and the POWER_GOOD# bit in STATUS_WORD and the POWER_GOOD# bit in the associated STATUS_MFR_SPECIFIC is set (Figure 3). The POWER_GOOD_OFF level is normally set lower than the POWER_GOOD_ON level. The 2 data bytes are in DIRECT format. This command is ignored if the channel is disabled or configured to monitor current.

USER NOTE: The PGn outputs are forced high impedance if the channel is disabled or if the channel is configured to measure current.

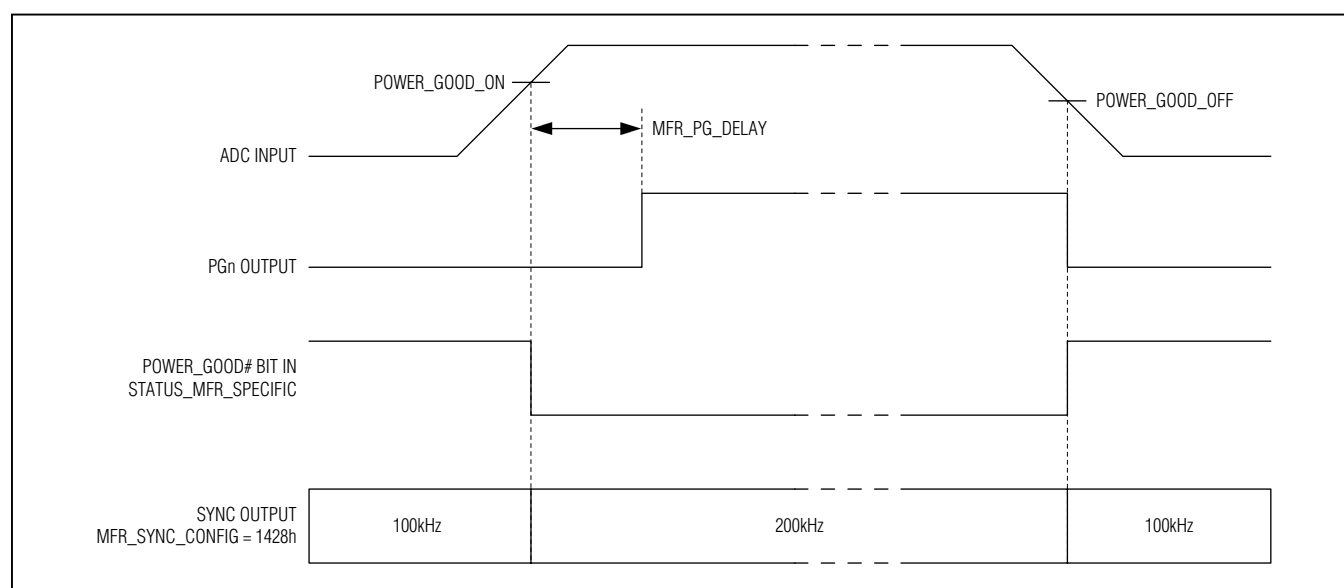

Figure 3. Power Good, SYNC Output, and Status Bit Timing

MAX34446

PMBus Power-Supply Data Logger

STATUS_BYTE (78h)

The STATUS_BYTE command returns 1 byte of information with a summary of the most critical faults. A value of 1 indicates that a fault or warning event has occurred and a 0 indicates otherwise. Bits for unsupported features are reported as 0. The STATUS_BYTE cannot be restored by RESTORE_DEFAULT_ALL command. [Table 10](#) describes the STATUS_BYTE message content. This command is read-only.

Table 10. STATUS_BYTE

BIT	BIT NAME	MEANING
7:6	0	These bits always return a 0.
5	VOUT_OV	An overvoltage fault has occurred.
4	IOUT_OC	An overcurrent fault has occurred.
3	0	This bit always returns a 0.
2	TEMPERATURE	A temperature fault or warning has occurred.
1	CML	A communication, memory, or logic fault has occurred.
0	NONE OF THE ABOVE	A fault or warning not listed in bits [7:1] has occurred.

STATUS_WORD (79h)

The STATUS_WORD command returns 2 bytes of information with a summary of the reason for a fault. The low byte of the STATUS_WORD is the same data as the STATUS_BYTE. [Table 11](#) describes the STATUS_WORD message content.

Table 11. STATUS_WORD

BIT	BIT NAME	MEANING
15	VOUT	An output voltage fault has occurred.
14:13	0	These bits always return a 0.
12	MFR	A bit in STATUS_MFR_SPECIFIC has been set.
11	POWER_GOOD#	Global power good has been negated. Applies to all monitored voltages. This is a status-only bit and is not latched.
10:6	0	These bits always return a 0.
5	VOUT_OV	An overvoltage fault has occurred.
4	IOUT_OC	An overcurrent fault has occurred.
3	0	This bit always returns a 0.
2	TEMPERATURE	A temperature fault or warning has occurred.
1	CML	A communication, memory, or logic fault has occurred.
0	NONE OF THE ABOVE	A fault or warning not listed in bits [7:1] has occurred.

STATUS_VOUT (7Ah)

The STATUS_VOUT command returns 1 byte of information with contents as described in [Table 12](#).

Table 12. STATUS_VOUT

BIT	BIT NAME	MEANING
7	VOUT_OV_FAULT	VOUT overvoltage fault.
6	VOUT_OV_WARN	VOUT overvoltage warning.
5	VOUT_UV_WARN	VOUT undervoltage warning.
4	VOUT_UV_FAULT	VOUT undervoltage fault.
3:0	0	These bits always return a 0.

MAX34446

PMBus Power-Supply Data Logger

STATUS_CML (7Eh)

The STATUS_CML command returns 1 byte of information with contents as described in [Table 13](#).

Table 13. STATUS_CML

BIT	BIT NAME	MEANING
7	COMM_FAULT	An invalid or unsupported command has been received.
6	DATA_FAULT	An invalid or unsupported data has been received.
5:1	0	These bits always return a 0.
0	FAULT_LOG_FULL	MFR_NV_FAULT_LOG is full and needs to be cleared.

Note: When NV Fault Log Overwrite is enabled (NV_LOG_OVERWRITE = 1 in MFR_MODE), FAULT_LOG_FULL is set when the fault log is full, but clears when the fault log is overwritten since two fault logs are cleared before each overwrite.

STATUS_MFR_SPECIFIC (80h)

The STATUS_MFR_SPECIFIC command returns 1 byte of information with a summary of the reason for a fault. The STATUS_MFR_SPECIFIC message content is described in [Table 14](#).

Table 14. STATUS_MFR_SPECIFIC

BIT	BIT NAME	MEANING
7	LOCKED	Set when the device is password protected. This is a status-only bit and is not latched.
6	OT_WARN	Overtemperature warning.
5	OT_FAULT	Overtemperature fault.
4	WATCHDOG	A watchdog reset has occurred.
3	0	This bit always returns a 0.
2	POWER_GOOD#	Individual power good has been negated. Only applies to the selected page. This is a status-only bit and is not latched.
1	OC_FAULT	IOUT overcurrent fault.
0	OC_WARN	IOUT overcurrent warning.

READ_VOUT (8Bh)

The READ_VOUT command returns the actual measured remote voltage. The 2 data bytes are in DIRECT format. When the ENABLE pin is low, this command returns 0000h when read.

READ_IOUT (8Ch)

The READ_IOUT command returns the latest measured current value. The 2 data bytes are in DIRECT format. When the ENABLE pin is low, this command returns 0000h when read.

READ_TEMPERATURE_1 (8Dh)

The READ_TEMPERATURE_1 command returns the temperature reading. The 2 data bytes are in DIRECT format. When the ENABLE pin is low, this command returns 0000h when read.

MAX34446

PMBus Power-Supply Data Logger

READ_POUT (96h)

The READ_POUT command returns the latest calculated power-measurement value for ADC0/1 and ADC2/3 voltage/current-coupled measurements as shown in [Table 15](#). The 2 data bytes are in DIRECT format. When the ENABLE pin is low, this command returns 0000h when read.

Table 15. READ_POUT Power-Measurement Values

PAGE	COMMAND	DESCRIPTION
0	READ_VOUT	READ_POUT = READ_VOUT x READ_IOUT
1	READ_IOUT	
2	READ_VOUT	READ_POUT = READ_VOUT x READ_IOUT
3	READ_IOUT	

PMBUS_REVISION (98h)

The PMBUS_REVISION command returns the revision of the PMBus specification to which the device is compliant. The command has 1 data byte. Bits [7:4] indicate the revision of PMBus specification Part I to which the device is compliant. Bits [3:0] indicate the revision of PMBus specification Part II to which the device is compliant. This command is read-only. The PMBUS_REVISION value returned is always 11h, which indicates that the device is compliant with Part I Rev 1.1 and Part II Rev 1.1.

MFR_ID (99h)

The MFR_ID command returns the text (ISO/IEC 8859-1) character of the manufacturer's (Maxim) identification. The default MFR_ID value is 4Dh (M). This command is read-only.

MFR_MODEL (9Ah)

The MFR_MODEL command returns the text (ISO/IEC 8859-1) character of the MAX34446 model number. The default MFR_MODEL value is 54h (T). This command is read-only.

MFR_REVISION (9Bh)

The MFR_REVISION command returns two text (ISO/IEC 8859-1) characters that contain the device revision numbers for hardware (upper byte) and firmware (lower byte). This command is read-only.

MFR_LOCATION (9Ch)

The MFR_LOCATION command loads the device with text (ISO/IEC 8859-1) characters that identify the facility that manufactures the power supply. The maximum number of characters is 8. This data is written to internal flash using the STORE_DEFAULT_ALL command. The factory default text string value is 10101010.

MFR_DATE (9Dh)

The MFR_DATE command loads the device with text (ISO/IEC 8859-1) characters that identify the date of manufacture of the power supply. The maximum number of characters is 8. This data is written to internal flash using the STORE_DEFAULT_ALL command. The factory default text string value is 10101010.

MFR_SERIAL (9Eh)

The MFR_SERIAL command loads the device with text (ISO/IEC 8859-1) characters that uniquely identify the device. The maximum number of characters is 8. This data is written to internal flash using the STORE_DEFAULT_ALL command. The factory default text string value is 10101010. The upper 4 bytes of MFR_SERIAL are used to unlock a device that has been password protected. The lower 4 bytes of MFR_SERIAL are not used to unlock a device and they can be set to any value.

PMBus Power-Supply Data Logger

MFR_MODE (D1h)

The MFR_MODE command is used to configure the device to support manufacturer-specific commands. [Table 16](#) describes the MFR_MODE command. After this command is sent, another command should not be sent for at least 250ms.

Table 16. MFR_MODE

BIT	BIT NAME	MEANING			
15	FORCE_NV_FAULT_LOG	Setting this bit to 1 forces the device to log data into the nonvolatile fault log. Once set, the device clears this bit when the action is completed. The host must set again for subsequent action. If an error occurs during this action, the device sets the CML bit in STATUS_BYTE and STATUS_WORD; no bits are set in STATUS_CML.			
14	CLEAR_NV_FAULT_LOG	Setting this bit to 1 forces the device to clear the nonvolatile fault log by writing FFh to all byte locations. Once set, the device clears this bit when the action is completed. The host must set again for subsequent action. If an error occurs during this action, the device sets the CML bit in STATUS_BYTE and STATUS_WORD; no bits are set in STATUS_CML. While clearing the fault log, monitoring is stopped and commands should not be sent to the PMBus port.			
13:12	LOGSKIP[1:0]	These bits determine if the device should log every ADC result or skip some readings to extend the time depth of the data buffer.			
		LOGSKIP1	LOGSKIP0	ADC RESULT LOGGING	NV LOG DEPTH (ms)
		0	0	Log every result	40
		0	1	Log every 2nd result	80
		1	0	Log every 4th result	160
1	1	Log every 8th result	320		
11	SOFT_RESET	This bit must be set, then cleared and set again within 8ms for a soft reset to occur.			
10	LOCK	This bit must be set, then cleared and set again within 8ms for the device to become password protected. This bit is cleared when the password is unlocked.			
9	NV_LOG_OVERWRITE	0 = Do not overwrite the NV Fault Log. 1 = Overwrite the NV Fault Log once it is full. Note: The device clears two fault logs at a time when overwrite is enabled.			
8	0	This bit always returns a 0.			
7	PG_PP_OD	Applies to all PGn outputs. 0 = PGn push-pull output. 1 = PGn open-drain output.			
6:2	0	These bits always return a 0.			
1:0	CHANNEL[1:0]	These bits determine which channels of ADC0 to ADC3 are enabled. Unused channels should be connected to V _{SS} . Whether voltage or current is monitored on the channel is selected with the IOUT_OC_FAULT_LIMIT command.			
		CHANNEL1	CHANNEL0	NO. OF CHANNELS MONITORED	ADC CHANNELS ENABLED
		0	0	0	None
		0	1	1	ADC0
		1	0	2	ADC0 and ADC1
1	1	4	ADC0 to ADC3		

MAX34446

PMBus Power-Supply Data Logger

MFR_VOUT_PEAK (D4h)

The MFR_VOUT_PEAK command returns the maximum measured output voltage. To reset this value to 0, write to this command with a data value of 0. The 2 data bytes are in DIRECT format. When the ENABLE pin goes low or the channel is disabled, this command resets to 0000h.

MFR_IOUT_PEAK (D5h)

The MFR_IOUT_PEAK command returns the maximum measured current. To reset this value to 0, write to this command with a data value of 0. The 2 data bytes are in DIRECT format. When the ENABLE pin goes low or the channel is disabled, this command resets to 0000h.

MFR_TEMPERATURE_PEAK (D6h)

The MFR_TEMPERATURE_PEAK command returns the maximum measured temperature. To reset this value to its lowest value, write to this command with a data value of 8000h. The 2 data bytes are in DIRECT format. When the ENABLE pin goes low or the channel is disabled, this command resets to 8000h.

MFR_VOUT_MIN (D7h)

The MFR_VOUT_MIN command returns the minimum measured output voltage. To reset this value, write to this command with a data value of 7FFFh. The 2 data bytes are in DIRECT format. When the ENABLE pin goes low or the channel is disabled, this command resets to 7FFFh.

PMBus Power-Supply Data Logger

MFR_FAULT_RESPONSE (D9h)

The MFR_FAULT_RESPONSE command specifies the response to each fault condition supported by the device. In response to a fault, the device always reports the fault in the appropriate status register. A CML fault cannot cause any device action other than setting the status bit. [Table 17](#) describes the MFR_FAULT_RESPONSE command.

Table 17. MFR_FAULT_RESPONSE

BIT	BIT NAME	MEANING
7:6	NV_LOG_EN[1:0]	0x = Never log MFR_NV_FAULT_LOG 10 = Log MFR_NV_FAULT_LOG on faults only. 11 = Log MFR_NV_FAULT_LOG on faults or warnings.
5	NV_LOG_OV	This bit is only valid for pages 0 to 3. Other pages always return a 0. These bits are used only if the channel is configured to monitor voltage. 0 = Bits 7:6 are ignored for overvoltage faults or warnings. 1 = Bits 7:6 also applies to overvoltage faults or warnings.
4	UV_OV_OC_FILTER	This bit is only valid for pages 0 to 3. Other pages always return a 0. 0 = Fault/warn on first sample excursion occurrence. 1 = Requires two consecutive sample excursions before a fault/warning is declared and action is taken. One passing sample is needed to clear a fault/warning.
3	0	This bit always returns a 0.
2	LATCHOFF	Normally after a fault, the device continues monitoring the afflicted parameter for the fault to clear and releases the FAULTn pin from being asserted low and logs future faults (if so enabled) once the currently accused fault clears. If this bit is set, the associated FAULTn output is latched in the asserted state (low) and no future fault logs are created until a VDD power cycle or hardware or software reset occurs. Warnings do not latch a channel off. 0 = Latchoff disabled. 1 = Latchoff enabled.
1:0	FAULT_EN[1:0]	0x = Never assert the FAULTn pin. 10 = Assert the FAULTn pin on faults only. 11 = Assert the FAULTn pin on faults or warnings.

Note: For fault responses, a fault is defined as either an undervoltage fault, overcurrent fault, or an overtemperature fault. Bit 6 allows the addition of an overvoltage fault to the fault condition.

MFR_FAULT_RETRY (DAh)

The MFR_FAULT_RETRY command sets the time the FAULTn output should remain active after the fault has been cleared. This command sets the time delay in multiples of 1ms. The 2 data bytes are in DIRECT format. When MFR_FAULT_RETRY = 0000h, the delay is disabled and the FAULTn output deasserts immediately after the fault condition is removed.

MFR_PG_DELAY (DBh)

The MFR_PG_DELAY command sets the delay time between when power good is determined and the associated PGN pin is asserted. This command sets the time delay in multiples of 1ms. The 2 data bytes are in DIRECT format. When MFR_PG_DELAY = 0000h, the delay is disabled and the PGN output is asserted immediately after power good is declared.

PMBus Power-Supply Data Logger

MFR_NV_FAULT_LOG (DCh)

Each time the MFR_NV_FAULT_LOG command is executed, the device returns a block of 255 bytes containing one of the 64 nonvolatile fault logs. The MFR_NV_FAULT_LOG command must be executed 64 times to dump the complete nonvolatile fault log. If the returned fault log contains all FFh, this indicates that the fault log has not been written by the device. As the device is operating, it is reading the latest operating conditions for voltage, current, and temperature and it is updating the status registers. All of this information is stored in on-board RAM. When a fault/warning is detected (if so enabled in MFR_FAULT_RESPONSE), the device automatically logs this information to one of the 64 nonvolatile fault logs. After 64 fault logs are written, bit 0 of STATUS_CML is set and the device can be configured (with the NV_LOG_OVERWRITE bit in MFR_MODE) to either stop writing additional fault logs or to write over the oldest data. The host can clear the fault log by setting the CLEAR_NV_FAULT_LOG bit in MFR_MODE.

All the latest status, temperature, and peak/minimum excursion information is logged. Also, 160 bytes of the 255-byte log are dedicated to report the latest ADC readings of voltage and current. The number of readings per ADC channels depends on the number of channels enabled. See [Table 18](#). Also, the LOGSKIP bits in the MFR_MODE command can be used to allow the device to only log every 2nd, 4th, or 8th reading so that the fault log can record data over a longer time frame (see [Table 16](#)).

Table 18. MFR_NV_FAULT_LOG 160-Byte Running Voltage/Current Log Format

1 CHANNEL ENABLED	2 CHANNELS ENABLED	4 CHANNELS ENABLED
80 Readings for ADC0, Data Buffer 0 to 79	40 Readings for ADC0, Data Buffer 0 to 39	20 Readings for ADC0, Data Buffer 0 to 19
	40 Readings for ADC1, Data Buffer 40 to 79	20 Readings for ADC1, Data Buffer 20 to 39
		20 Readings for ADC2, Data Buffer 40 to 59
		20 Readings for ADC3, Data Buffer 60 to 79

Note: The number of ADC channels is configured with the CHANNEL bits in the MFR_MODE command.

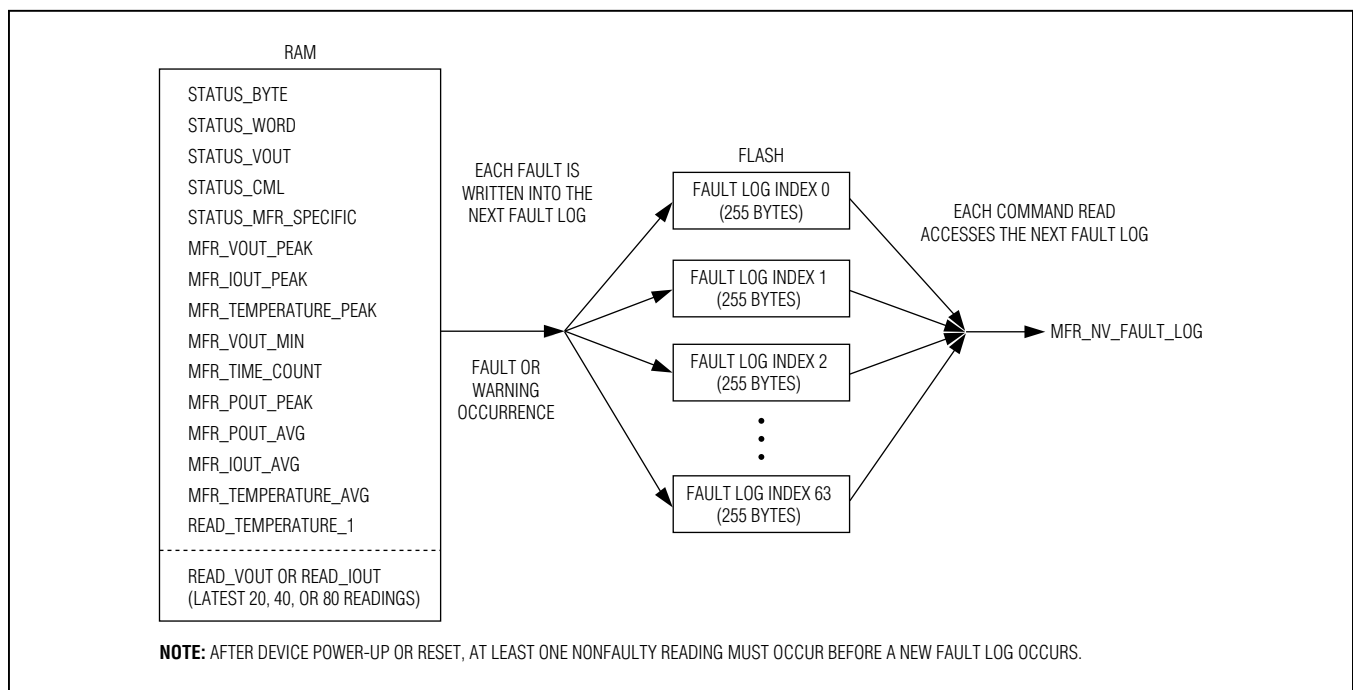

Figure 4. NV Fault Logging Arrangement

PMBus Power-Supply Data Logger

If the device is not enabled to measure either current or voltage, or if a temperature sensor is disabled, the associated fault-log byte position returns 0000h.

There is a FAULT_LOG_COUNT (16-bit counter) at the beginning of each fault log that indicates which fault log is the latest. This counter rolls over should more than 65,535 faults be logged. This counter is not cleared when the CLEAR_NV_FAULT_LOG bit in MFR_MODE is toggled. [Table 19](#) describes the 255 bytes returned by the MFR_NV_FAULT_LOG command.

USER NOTE: V_{DD} must be above 2.9V for the device to clear or log data into MFR_NV_FAULT_LOG. During a write to the fault log, the device temporarily stops monitoring and does not respond to SMBus commands.

Table 19. MFR_NV_FAULT_LOG

BYTE	PARAMETER	BYTE	PARAMETER
0	00h/FAULT_LOG_INDEX	128	DATA BUFFER 34
2	FAULT_LOG_COUNT	130	DATA BUFFER 35
4	MFR_TIME_COUNT (LSW)	132	DATA BUFFER 36
6	MFR_TIME_COUNT (MSW)	134	DATA BUFFER 37
8	STATUS_BYTE / STATUS_CML	136	DATA BUFFER 38
10	STATUS_WORD	138	DATA BUFFER 39
12	STATUS_VOUT Pages 0/1	140	DATA BUFFER 40
14	STATUS_VOUT Pages 1/2	142	DATA BUFFER 41
16	STATUS_MFR_SPECIFIC Pages 0/1	144	DATA BUFFER 42
18	STATUS_MFR_SPECIFIC Pages 2/3	146	DATA BUFFER 43
20	STATUS_MFR_SPECIFIC Pages 4/5	148	DATA BUFFER 44
22	STATUS_MFR_SPECIFIC Page 6/00h	150	DATA BUFFER 45
24	RESERVED (0000h)	152	DATA BUFFER 46
26	RESERVED (0000h)	154	DATA BUFFER 47
28	RESERVED (0000h)	156	DATA BUFFER 48
30	CURRENT_CHANNELS/00h (Note 1)	158	DATA BUFFER 49
32	READ_VOUT or IOUT Page 0	160	DATA BUFFER 50
34	READ_VOUT or IOUT Page 1	162	DATA BUFFER 51
36	READ_VOUT or IOUT Page 2	164	DATA BUFFER 52
38	READ_VOUT or IOUT Page 3	166	DATA BUFFER 53
40	MFR_VOUT or IOUT PEAK Page 0	168	DATA BUFFER 54
42	MFR_VOUT or IOUT PEAK Page 1	170	DATA BUFFER 55
44	MFR_VOUT or IOUT PEAK Page 2	172	DATA BUFFER 56
46	MFR_VOUT or IOUT PEAK Page 3	174	DATA BUFFER 57
48	MFR_VOUT_MIN or IOUTAVG Page 0	176	DATA BUFFER 58
50	MFR_VOUT_MIN or IOUTAVG Page 1	178	DATA BUFFER 59
52	MFR_VOUT_MIN or IOUTAVG Page 2	180	DATA BUFFER 60
54	MFR_VOUT_MIN or IOUTAVG Page 3	182	DATA BUFFER 61
56	RESERVED (0000h)	184	DATA BUFFER 62
58	BUFFER INDEX/NUMBER_OF_CH (Notes 2, 3)	186	DATA BUFFER 63
60	DATA BUFFER 0	188	DATA BUFFER 64
62	DATA BUFFER 1	190	DATA BUFFER 65
64	DATA BUFFER 2	192	DATA BUFFER 66

PMBus Power-Supply Data Logger

Table 19. MFR_NV_FAULT_LOG (continued)

BYTE	PARAMETER	BYTE	PARAMETER
66	DATA BUFFER 3	194	DATA BUFFER 67
68	DATA BUFFER 4	196	DATA BUFFER 68
70	DATA BUFFER 5	198	DATA BUFFER 69
72	DATA BUFFER 6	200	DATA BUFFER 70
74	DATA BUFFER 7	202	DATA BUFFER 71
76	DATA BUFFER 8	204	DATA BUFFER 72
78	DATA BUFFER 9	206	DATA BUFFER 73
80	DATA BUFFER 10	208	DATA BUFFER 74
82	DATA BUFFER 11	210	DATA BUFFER 75
84	DATA BUFFER 12	212	DATA BUFFER 76
86	DATA BUFFER 13	214	DATA BUFFER 77
88	DATA BUFFER 14	216	DATA BUFFER 78
90	DATA BUFFER 15	218	DATA BUFFER 79
92	DATA BUFFER 16	220	RESERVED (0000h)
94	DATA BUFFER 17	222	READ_POUT Pages 0/1
96	DATA BUFFER 18	224	READ_POUT Pages 2/3
98	DATA BUFFER 19	226	MFR_POUT_PEAK Pages 0/1
100	DATA BUFFER 20	228	MFR_POUT_PEAK Pages 2/3
102	DATA BUFFER 21	230	MFR_POUT_AVG Pages 0/1
104	DATA BUFFER 22	232	MFR_POUT_AVG Pages 2/3
106	DATA BUFFER 23	234	RESERVED (0000h)
108	DATA BUFFER 24	236	READ_TEMPERATURE_1 Page 4
110	DATA BUFFER 25	238	READ_TEMPERATURE_1 Page 5
112	DATA BUFFER 26	240	READ_TEMPERATURE_1 Page 6
114	DATA BUFFER 27	242	MFR_TEMPERATURE_PEAK Page 4
116	DATA BUFFER 28	244	MFR_TEMPERATURE_PEAK Page 5
118	DATA BUFFER 29	246	MFR_TEMPERATURE_PEAK Page 6
120	DATA BUFFER 30	248	MFR_TEMPERATURE_AVG Page 4
122	DATA BUFFER 31	250	MFR_TEMPERATURE_AVG Page 5
124	DATA BUFFER 32	252	MFR_TEMPERATURE_AVG Page 6
126	DATA BUFFER 33	254	LOG_VALID (Note 4)

Note 1: CURRENT_CHANNELS is a bitmask indicating which channels are enabled for current measurement. A reading of 0Ah indicates channels 1 and 3 are enabled to measure current.

Note 2: BUFFER_INDEX is the index of the buffer where the most recent data is being written. The maximum value for BUFFER_INDEX is dependent upon the number of channels enabled.

Note 3: NUMBER_OF_CH indicates how many of the voltage/current channels are enabled.

Note 4: LOG_VALID is set to DDh if the fault log contains valid data.

MAX34446

PMBus Power-Supply Data Logger

MFR_TIME_COUNT (DDh)

The MFR_TIME_COUNT command returns the number of seconds of device lifetime operation. Once every hour, the device automatically stores this counter in flash memory. Also, the falling edge of the ENABLE input causes the device to attempt to store MFR_TIME_COUNT into flash memory as long as V_{DD} is above 2.9V. The counter is a 32-bit value that rolls over. The latest stored value is automatically recalled from flash memory upon device power cycle, \overline{RST} action, or a soft reset. This count can be reset to zero by writing a sequence of all zeros (00000000h), followed by all ones (FFFFFFFFh), followed by all zeros (00000000h) within 8ms.

MFR_POUT_PEAK (E0h)

The MFR_POUT_PEAK command returns the maximum calculated power. To reset this value to zero, write to this command with a data value of zero. The 2 data bytes are in DIRECT format. When the ENABLE pin goes low or the channel is disabled, this command resets to 0000h.

MFR_POUT_AVG (E1h)

The MFR_POUT_AVG command returns the calculated average power. To reset the average, write to this command with a data value of zero. Any other values written by this command are ignored. The 2 data bytes are in DIRECT format. When the ENABLE pin goes low or the channel is disabled, this command resets to 0000h.

MFR_IOUT_AVG (E2h)

The MFR_IOUT_AVG command returns the calculated average current. To reset the average, write to this command with a data value of zero. Any other values written by this command are ignored. The 2 data bytes are in DIRECT format. When the ENABLE pin goes low or the channel is disabled, this command resets to 0000h.

MFR_TEMPERATURE_AVG (E3h)

The MFR_TEMPERATURE_AVG command returns the calculated average temperature. To reset the average, write to this command with a data value of zero. Any other values written by this command are ignored. The 2 data bytes are in DIRECT format. When the ENABLE pin goes low or the channel is disabled, this command resets to 0000h.

MFR_SYNC_CONFIG (EFh)

The MFR_SYNC_CONFIG command determines the action of the SYNC output. The SYNC output can be programmed with the MFR_SYNC_CONFIG command to switch between two frequencies depending on the power-good state. MFR_SYNC_CONFIG is a 2-byte command. The MSB contains the SYNC frequency when all voltage channels have reached a power-good state. The LSB contains the SYNC frequency when any of the voltage channels is not in a power-good state. The format for the LSB and MSB to set the SYNC frequency is an integer between 8 and 200 (inclusive). The programmed integer is divided into the 4MHz on-board system oscillator to create the SYNC frequency.

As shown in [Table 20](#), if MFR_SYNC_CONFIG was programmed as 19C8h, then the SYNC output would be 160kHz in a power-good state and 20kHz when any of the voltage channels are not in a power-good state. If either byte of MFR_SYNC_CONFIG is set to 00h, the SYNC output is forced to high impedance during the respective power-good state. It is acceptable to have both the MSB and the LSB programmed to the same frequency, which eliminates the frequency dependency on the state of power good. See [Figure 3](#) for more timing details.

Table 20. MFR_SYNC_CONFIG Examples

MFR_SYNC_CONFIG MSB OR LSB VALUE (HEX)	SYSTEM OSCILLATOR (MHz)	DIVIDE INTEGER (DECIMAL)	SYNC FREQUENCY (SYSTEM OSCILLATOR/INTEGER) (kHz)
08h	4	8	500
19h	4	25	160
7Dh	4	125	32
C8h	4	200	20

MAX34446

PMBus Power-Supply Data Logger

Applications Information

Power-Supply Decoupling

To achieve the best results when using the device, decouple the V_{DD} power supply with a $0.1\mu\text{F}$ capacitor. Use a high-quality, ceramic, surface-mount capacitor if possible. Surface-mount components minimize lead inductance, which improves performance, and ceramic capacitors tend to have adequate high-frequency response for decoupling applications.

Decouple the REG18 regulator output using $1\mu\text{F}$ and 10nF capacitors (one each per output).

Decouple the REG25 pin with $30\mu\text{F}$ to $47\mu\text{F}$ of capacitance with an ESR of 0Ω to $500\text{m}\Omega$.

Open-Drain Pins

SCL, SDA, $\overline{\text{FAULTn}}$, and PGn (when set in MFR_MODE) are open-drain pins and require external pullup resistors connected to V_{DD} to realize high-logic levels.

Protecting Input Pins

In applications where voltages can be applied to the $\text{RS+}[5:0]$ pins when V_{DD} is grounded, a series 100Ω resistor is recommended on these pins to protect the device by limiting power dissipation.

In applications where voltage can be applied to any other pin when V_{DD} is grounded, a series resistor of 750Ω or greater is recommended on these pins to protect the device by limiting power dissipation.

Ordering Information

PART	TEMP RANGE	PIN-PACKAGE
MAX34446ETL+	-40°C to +105°C	40 TQFN-EP*
MAX34446ETL+T	-40°C to +105°C	40 TQFN-EP*

+Denotes a lead(Pb)-free/RoHS-compliant package.

T = Tape and reel.

*EP = Exposed pad.

Package Information

For the latest package outline information and land patterns (footprints), go to www.maximintegrated.com/packages. Note that a "+", "#", or "-" in the package code indicates RoHS status only. Package drawings may show a different suffix character, but the drawing pertains to the package regardless of RoHS status.

PACKAGE TYPE	PACKAGE CODE	OUTLINE NO.	LAND PATTERN NO.
40 TQFN-EP	T4066+2	21-0141	90-0053

MAX34446

PMBus Power-Supply Data Logger

Typical Application Circuit/Block Diagram

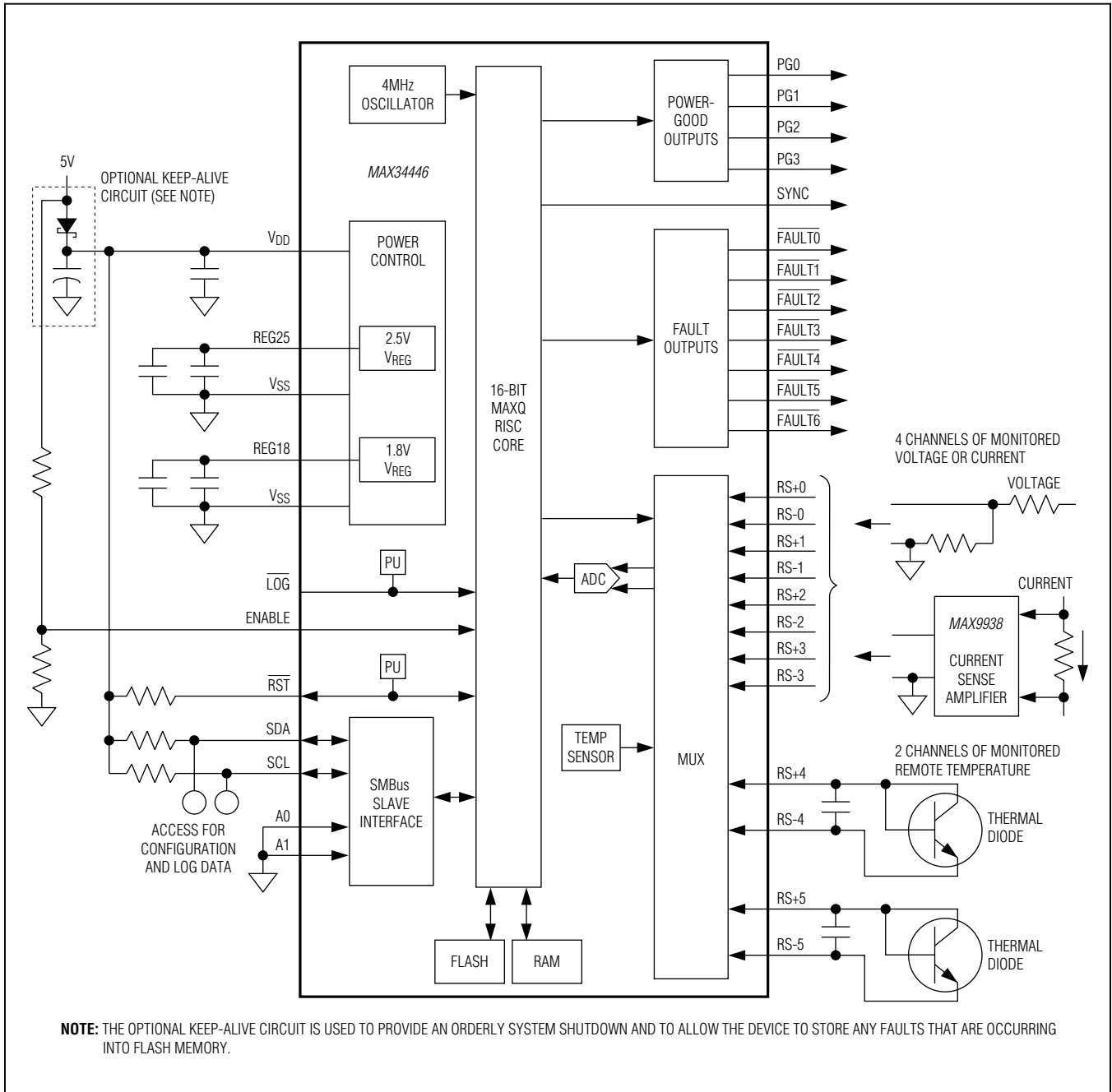

MAX34446

PMBus Power-Supply Data Logger

Revision History

REVISION NUMBER	REVISION DATE	DESCRIPTION	PAGES CHANGED
0	5/11	Initial release	—
1	1/12	Added the continuous power dissipation numbers and changed the lead temperature from +260°C to +300°C in the <i>Absolute Maximum Ratings</i> section; changed the $V_{IL(MIN)}$ and $V_{I2C_IL(MIN)}$ specs from -0.3V to 0V in the <i>Recommended Operating Conditions</i> table; changed the INL(MAX) spec from ± 4 LSB to ± 8 LSB and removed the DNL parameter in the <i>DC Electrical Characteristics</i> table	2, 3
2	9/12	Added an NV fault log overwrite function and NV overwrite feature to the DC Electrical Characteristics table, Table 16, and <i>MFR_NV_FAULT_LOG (DCh)</i> section; updated the default value for 9Bh in Table 1 and <i>MFR_REVISION (9Bh)</i> section	3, 8, 25, 27, 30
3	10/13	Corrected and updated the <i>Absolute Maximum Ratings</i> section, changed the bus free time minimum specification, and added the <i>Protecting Input Pins</i> section	2, 4, 7, 19, 27, 34



Maxim Integrated cannot assume responsibility for use of any circuitry other than circuitry entirely embodied in a Maxim Integrated product. No circuit patent licenses are implied. Maxim Integrated reserves the right to change the circuitry and specifications without notice at any time. The parametric values (min and max limits) shown in the Electrical Characteristics table are guaranteed. Other parametric values quoted in this data sheet are provided for guidance.

Looking for pricing, stock, or lifecycle information?

Click below to explore more details on WIN SOURCE:

 [View MAX34446ETL+ on WIN SOURCE](#)

 [Maxim Integrated](#) Information

Optimize Your Supply Chain with WIN SOURCE Solutions

-  Global Sourcing Solution
-  Obsolete Management
-  Cost Control Management
-  Shortage Management
-  Alternative Solution
-  Excess Inventory Management