



**THE DATASHEET OF
MBR5200VPC-E1**



Product Summary

V_{RRM} (V)	I_o (A)	V_F (MAX) (V) @ +25°C	I_R (MAX) (mA) @ +25°C
200	5	0.95	0.5

Description

The MBR5200 is a high-voltage Schottky rectifier suited for switch mode power supplies and other power converters. This device is intended for use in medium voltage operation, and particularly, in high-frequency circuits where low switching losses and low noise are required.

The MBR5200 is available in standard DO-27, DO-27 (C), and DO-27 (Type YJ) packages.

Applications

- Power Supply-Output Rectification
- Power Management
- Instrumentation

Features

- Low Forward Voltage: 0.95V @ +25°C
- High Surge Current Capacity
- +150°C Operating Junction Temperature
- 5A Total
- Guard-Ring for Stress Protection
- Pb-Free Package is Available
- DO-27, DO-27 (C) and DO-27 (Type YJ)
- **Lead-Free Finish; RoHS Compliant (Notes 1 & 2)**
- **For automotive applications requiring specific change control (i.e. parts qualified to AEC-Q100/101/200, PPAP capable, and manufactured in IATF 16949 certified facilities), please [contact us](https://www.diodes.com/quality/product-definitions/) or your local Diodes representative. <https://www.diodes.com/quality/product-definitions/>**

Mechanical Data

- Case: DO-27, DO-27 (C), DO-27 (Type YJ)
- Case Material: Molded Plastic, "Green" Molding Compound. UL Flammability Classification Rating 94V-0
- Moisture Sensitivity: Level 1 per J-STD-020
- Terminals: Finish - Matte Tin Annealed over Copper Leadframe. Solderable per MIL-STD-202, Method 208 (3)
- Weight (Approximately): 1.13 grams

Pin Assignments

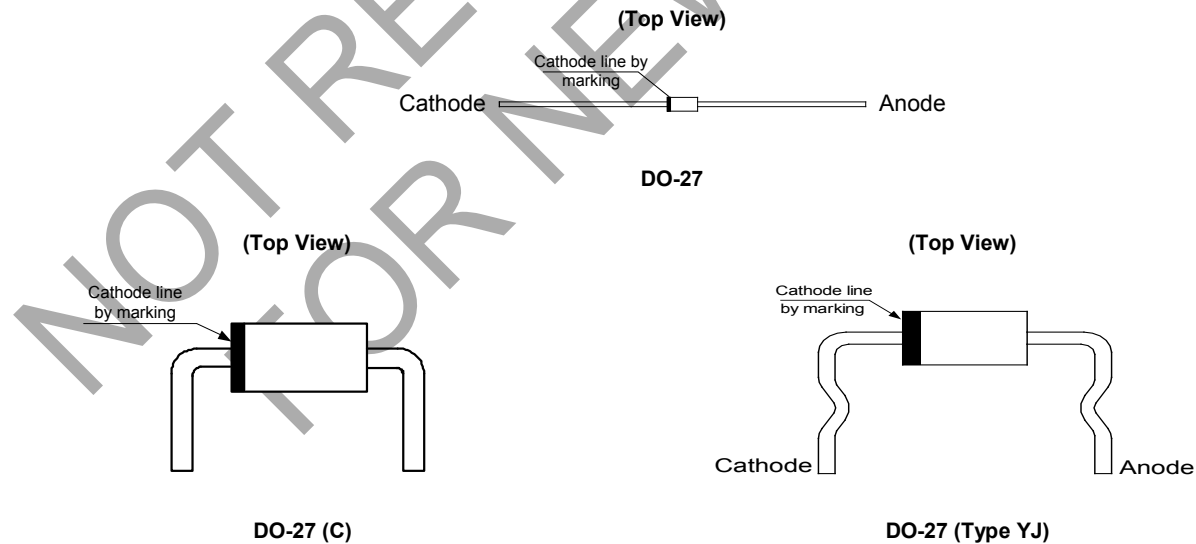

Notes: 1. EU Directive 2002/95/EC (RoHS), 2011/65/EU (RoHS 2) & 2015/863/EU (RoHS 3) compliant. All applicable RoHS exemptions applied.
2. See <https://www.diodes.com/quality/lead-free/> for more information about Diodes Incorporated's definitions of Halogen- and Antimony-free, "Green" and Lead-free.

Ordering Information

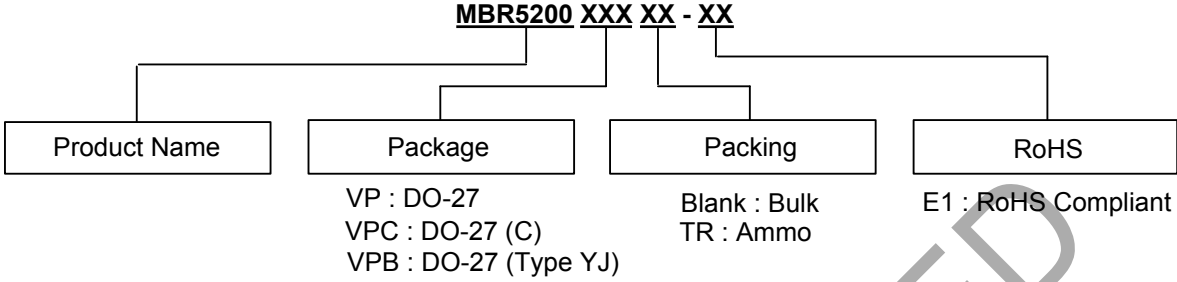

Package	Part Number	Marking ID	Packing
DO-27	MBR5200VPTR-E1	5200VP	500 Pieces/Ammo
DO-27 (Type YJ)	MBR5200VPBTR-E1	5200VPB	500 Pieces/Ammo
DO-27 (C)	MBR5200VPC-E1	5200VPC	500 Pieces/Bulk

Marking Information

(1) DO-27

(Top View)



First Line: Logo and Date Code
 Y: Year
 WW: Work Week of Molding
 A: Assembly House Code
 Second Line: Marking ID
 (See Ordering Information)

Marking Information (Cont.)

(2) DO-27 (C), DO-27 (Type YJ)

(Top View)



First Line: Logo and Date Code
 Y: Year
 WW: Work Week of Molding
 A: Assembly House Code
 Second Line: Marking ID
 (See Ordering Information)

Maximum Ratings (per Diode Leg) (Note 3)

Characteristic	Symbol	Rating	Unit
Peak Repetitive Reverse Voltage	V_{RRM}	200	V
Working Peak Reverse Voltage	V_{RWM}		
DC Blocking Voltage	V_R		
Average Rectified Forward Current (Rated V_R) $T_C = TBD$	$I_{F(AV)}$	5	A
Non Repetitive Peak Surge Current (Surge Applied at Rated Load Conditions Half Wave, Single Phase, 60Hz)	I_{FSM}	100	A
Operating Junction Temperature Range (Note 4)	T_J	-65 to +150	°C
Storage Temperature Range	T_{STG}	-65 to +150	°C
Voltage Rate of Change (Rated V_R)	dv/dt	10000	V/ μ s
ESD (Machine Model = C)	—	400	V
ESD (Human Body Model = 3B)	—	8000	V

Notes: 3. Stresses greater than those listed under "Absolute Maximum Ratings" may cause permanent damage to the device. These are stress ratings only, and functional operation of the device at these or any other conditions beyond those indicated under "Recommended Operating Conditions" is not implied. Exposure to "Absolute Maximum Ratings" for extended periods may affect device reliability.
 4. The heat generated must be less than the thermal conductivity from Junction to Ambient: $dP_D/dT_J < 1/\theta_{JA}$.

Thermal Characteristics

Characteristic	Symbol	Rating	Unit
Maximum Thermal Resistance (Junction to Case)	$R_{\theta JC}$	5	°C/W
Maximum Thermal Resistance (Junction to Ambient)	$R_{\theta JA}$	30	

Electrical Characteristics

Characteristic	Symbol	Rating	Unit	Test Condition
Maximum Instantaneous Forward Voltage Drop (Note 5)	V_F	0.95	V	$I_F = 5A, T_C = +25^\circ C$
		0.75		$I_F = 5A, T_C = +125^\circ C$
Maximum Instantaneous Reverse Current (Note 5)	I_R	0.5	mA	Rated DC Voltage, $T_C = +25^\circ C$
		1.0		Rated DC Voltage, $T_C = +125^\circ C$

Note: 5. Short duration pulse test used to minimize self-heating effect, Pulse Test: Pulse Width = 300µs, Duty Cycle ≤ 2.0%.

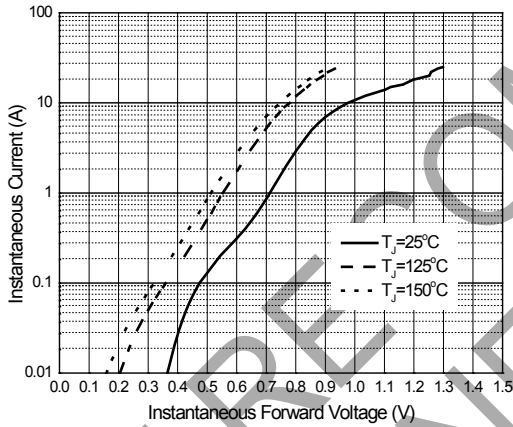

Figure 1. Typical Forward Characteristics

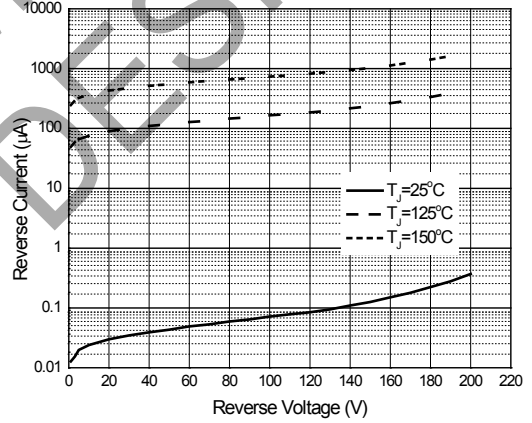

Figure 2. Typical Reverse Characteristics

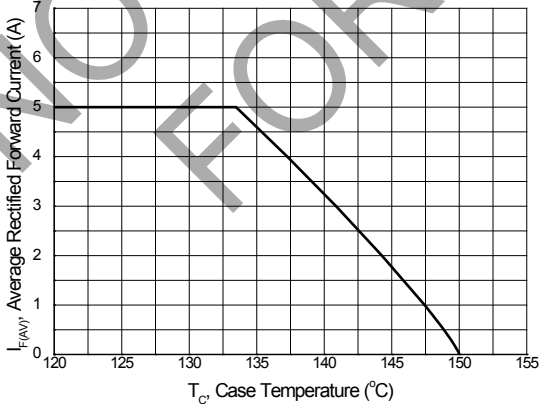

Figure 3. Average Rectified Forward Current vs. Case Temperature

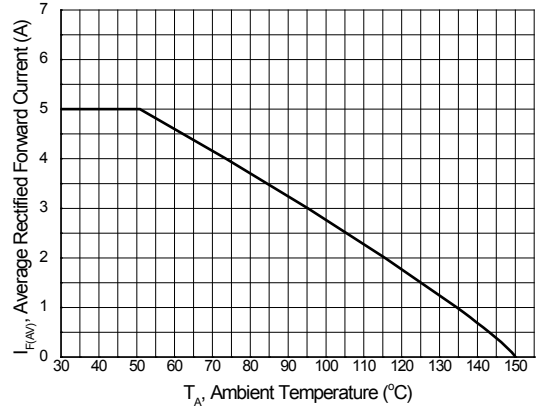
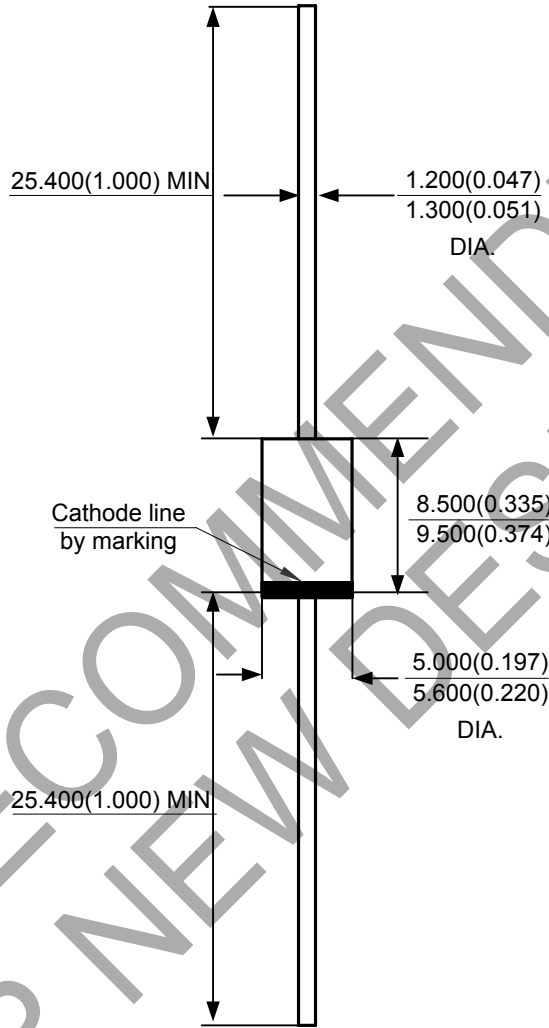

Figure 4. Average Rectified Forward Current vs. Ambient Temperature

Package Outline Dimensions (All dimensions in mm(inch).)

Please see <http://www.diodes.com/package-outlines.html> for the latest version.

(1) Package Type: DO-27



NOT RECOMMENDED FOR NEW DESIGN

Package Outline Dimensions (continued; All dimensions in mm(inch).)

Please see <http://www.diodes.com/package-outlines.html> for the latest version.

(2) **Package Type: DO-27 (C)**

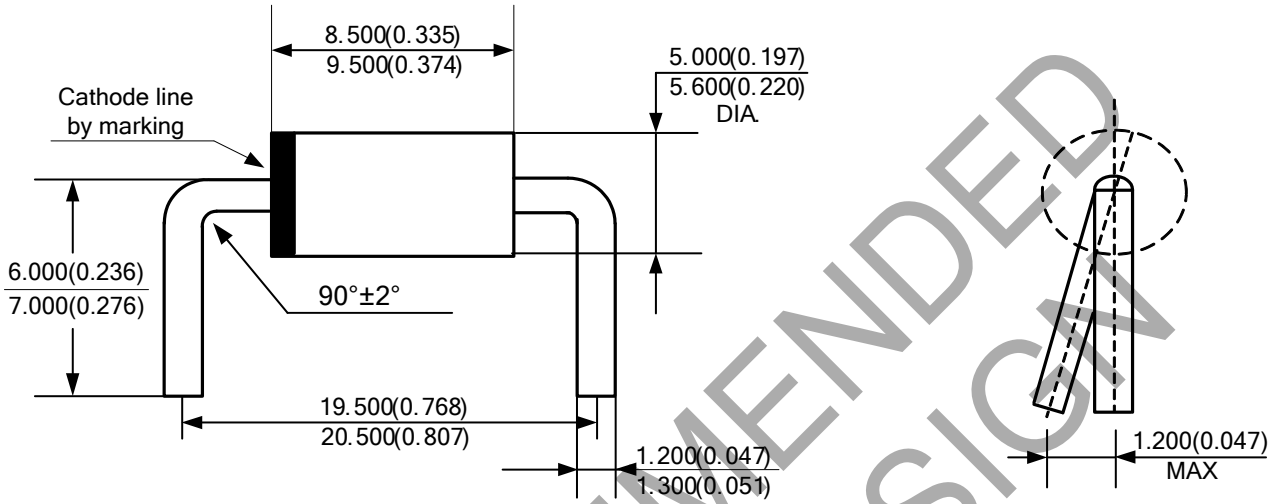

Package Outline Dimensions (cont.)

Please see <http://www.diodes.com/package-outlines.html> for the latest version.

(3) Package Type: DO-27 (Type YJ)

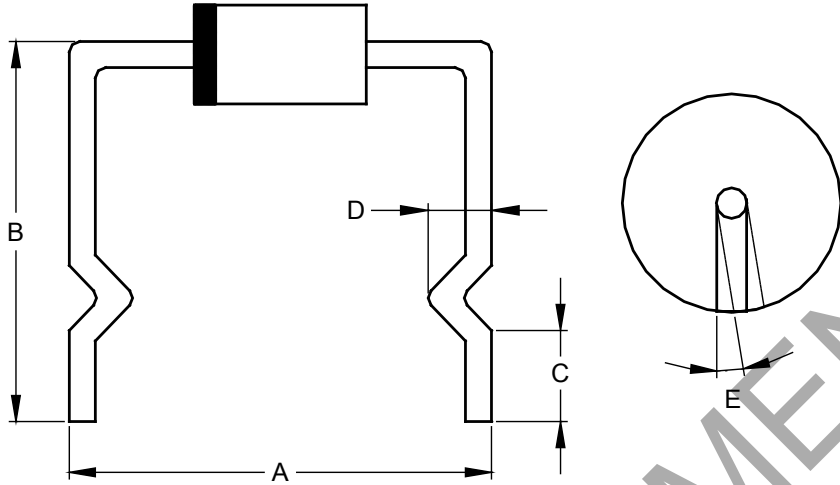

DO-27 (Type YJ)			
Dim	Min	Max	Typ
A	16.17	16.27	16.22
B	14.11	15.11	14.61
C	3.00	4.00	3.50
D	2.3	--	--
E	0°	1.5°	--
All Dimensions in mm			

NOT RECOMMENDED FOR NEW DESIGN

IMPORTANT NOTICE

DIODES INCORPORATED MAKES NO WARRANTY OF ANY KIND, EXPRESS OR IMPLIED, WITH REGARDS TO THIS DOCUMENT, INCLUDING, BUT NOT LIMITED TO, THE IMPLIED WARRANTIES OF MERCHANTABILITY AND FITNESS FOR A PARTICULAR PURPOSE (AND THEIR EQUIVALENTS UNDER THE LAWS OF ANY JURISDICTION).

Diodes Incorporated and its subsidiaries reserve the right to make modifications, enhancements, improvements, corrections or other changes without further notice to this document and any product described herein. Diodes Incorporated does not assume any liability arising out of the application or use of this document or any product described herein; neither does Diodes Incorporated convey any license under its patent or trademark rights, nor the rights of others. Any Customer or user of this document or products described herein in such applications shall assume all risks of such use and will agree to hold Diodes Incorporated and all the companies whose products are represented on Diodes Incorporated website, harmless against all damages.

Diodes Incorporated does not warrant or accept any liability whatsoever in respect of any products purchased through unauthorized sales channel. Should Customers purchase or use Diodes Incorporated products for any unintended or unauthorized application, Customers shall indemnify and hold Diodes Incorporated and its representatives harmless against all claims, damages, expenses, and attorney fees arising out of, directly or indirectly, any claim of personal injury or death associated with such unintended or unauthorized application.

Products described herein may be covered by one or more United States, international or foreign patents pending. Product names and markings noted herein may also be covered by one or more United States, international or foreign trademarks.

This document is written in English but may be translated into multiple languages for reference. Only the English version of this document is the final and determinative format released by Diodes Incorporated.

LIFE SUPPORT

Diodes Incorporated products are specifically not authorized for use as critical components in life support devices or systems without the express written approval of the Chief Executive Officer of Diodes Incorporated. As used herein:

A. Life support devices or systems are devices or systems which:

1. are intended to implant into the body, or
2. support or sustain life and whose failure to perform when properly used in accordance with instructions for use provided in the labeling can be reasonably expected to result in significant injury to the user.

B. A critical component is any component in a life support device or system whose failure to perform can be reasonably expected to cause the failure of the life support device or to affect its safety or effectiveness.



Customers represent that they have all necessary expertise in the safety and regulatory ramifications of their life support devices or systems, and acknowledge and agree that they are solely responsible for all legal, regulatory and safety-related requirements concerning their products and any use of Diodes Incorporated products in such safety-critical, life support devices or systems, notwithstanding any devices- or systems-related information or support that may be provided by Diodes Incorporated. Further, Customers must fully indemnify Diodes Incorporated and its representatives against any damages arising out of the use of Diodes Incorporated products in such safety-critical, life support devices or systems.

Copyright © 2020, Diodes Incorporated

www.diodes.com

Looking for pricing, stock, or lifecycle information?

Click below to explore more details on WIN SOURCE:

-  [View MBR5200VPC-E1 on WIN SOURCE](#)
-  [Diodes Incorporated Information](#)

Optimize Your Supply Chain with WIN SOURCE Solutions

-  Global Sourcing Solution
-  Obsolete Management
-  Cost Control Management
-  Shortage Management
-  Alternative Solution
-  Excess Inventory Management