



**THE DATASHEET OF
MC9S08SE4MTG**





MC9S08SE8

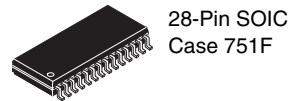

28-Pin SOIC
Case 751F

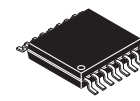

16-Pin TSSOP
Case 948F-01

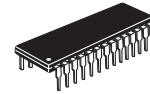

28-Pin PDIP
Case 710-02

MC9S08SE8 Series

**Covers: MC9S08SE8
MC9S08SE4**

Features:

- 8-Bit HCS08 Central Processor Unit (CPU)
 - 20 MHz HCS08 CPU (central processor unit)
 - 10 MHz internal bus frequency
 - HC08 instruction set with added BGND
 - Support for up to 32 interrupt/reset sources
- On-Chip Memory
 - Up to 8 KB of on-chip in-circuit programmable flash memory with block protection and security options
 - Up to 512 bytes of on-chip RAM
- Power-Saving Modes
 - Wait plus two stops
- Clock Source Options
 - Oscillator (XOSC) — Loop-control Pierce oscillator; crystal or ceramic resonator range of 31.25 kHz to 38.4 kHz or 1 MHz to 16 MHz
 - Internal Clock Source (ICS) — Internal clock source module containing a frequency-locked-loop (FLL) controlled by internal or external reference; precision trimming of internal reference allows 0.2% resolution and 2% deviation over temperature and voltage; supports bus frequencies from 1 MHz to 10 MHz.
- System Protection
 - Optional computer operating properly (COP) reset with option to run from independent 1 kHz internal clock source or the bus clock
 - Low voltage detection
 - Illegal opcode detection with reset
 - Illegal address detection with reset
- Development Support
 - Single-wire background debug interface
 - Breakpoint capability to allow single breakpoint setting during in-circuit debugging
- Peripherals
 - **SCI** — Full duplex non-return to zero (NRZ); LIN master extended break generation; LIN slave extended break detection; wakeup on active edge
 - **ADC** — 10-channel, 10-bit resolution; 2.5 μ s conversion time; automatic compare function; 1.7 mV/ $^{\circ}$ C temperature sensor; internal bandgap reference channel; runs in stop3
 - **TPMx** — One 2-channel (TPM1) and one 1-channel (TPM2) 16-bit timer/pulse-width modulator (TPM) modules; selectable input capture, output compare, and edge-aligned PWM capability on each channel; timer module may be configured for buffered, centered PWM (CPWM) on all channels
 - **KBI** — 8-pin keyboard interrupt module
 - **RTC** — Real-time counter with binary- or decimal-based prescaler
- Input/Output
 - Software selectable pullups on ports when used as inputs
 - Software selectable slew rate control on ports when used as outputs
 - Software selectable drive strength on ports when used as outputs
 - Master reset pin and power-on reset (POR)
 - Internal pullup on $\overline{\text{RESET}}$, IRQ, and BKGD/MS pins to reduce customer system cost
- Package Options
 - 28-pin PDIP
 - 28-pin SOIC
 - 16-pin TSSOP

This document contains information on a product under development. Freescale reserves the right to change or discontinue this product without notice.

Table of Contents

1	MCU Block Diagram	3	3.8	Internal Clock Source (ICS) Characteristics	20
2	Pin Assignments	4	3.9	ADC Characteristics	22
3	Electrical Characteristics	6	3.10	AC Characteristics	25
3.1	Parameter Classification	6	3.10.1	Control Timing	25
3.2	Absolute Maximum Ratings	6	3.10.2	TPM/MTIM Module Timing	26
3.3	Thermal Characteristics	7	3.11	Flash Specifications	27
3.4	ESD Protection and Latch-Up Immunity	8	4	Ordering Information	27
3.5	DC Characteristics	9	4.1	Package Information	28
3.6	Supply Current Characteristics	15	4.2	Mechanical Drawings	28
3.7	External Oscillator (XOSC) Characteristics	19			

Revision History

To provide the most up-to-date information, the revision of our documents on the World Wide Web will be the most current. Your printed copy may be an earlier revision. To verify you have the latest information available, refer to: freescale.com

The following revision history table summarizes changes contained in this document.

Revision	Date	Description of Changes
1	10/8/2008	Initial public released.
2	1/16/2009	In Table 8 , added the Max. of S2I _{DD} and S3I _{DD} in 0–105 °C; changed the Max. of S2I _{DD} and S3I _{DD} in 0–85 °C; changed the typical of S2I _{DD} and S3I _{DD} ; changed the S23I _{DDRTI} to P.
3	4/7/2009	Added I _{OZTOT} in the Table 7 . Changed V _{DDAD} to V _{DDA} , V _{SSAD} to V _{SSA} . Updated Table 9 , Table 10 , Table 11 , and Table 12 . Updated Figure 13 and Figure 14 .
4	4/10/2015	Updated Table 9 .

Related Documentation

Find the most current versions of all documents at: <http://www.freescale.com>

Reference Manual (MC9S08SE8RM)

Contains extensive product information including modes of operation, memory, resets and interrupts, register definition, port pins, CPU, and all module information.

1 MCU Block Diagram

The block diagram, [Figure 1](#), shows the structure of the MC9S08SE8 series MCUs.

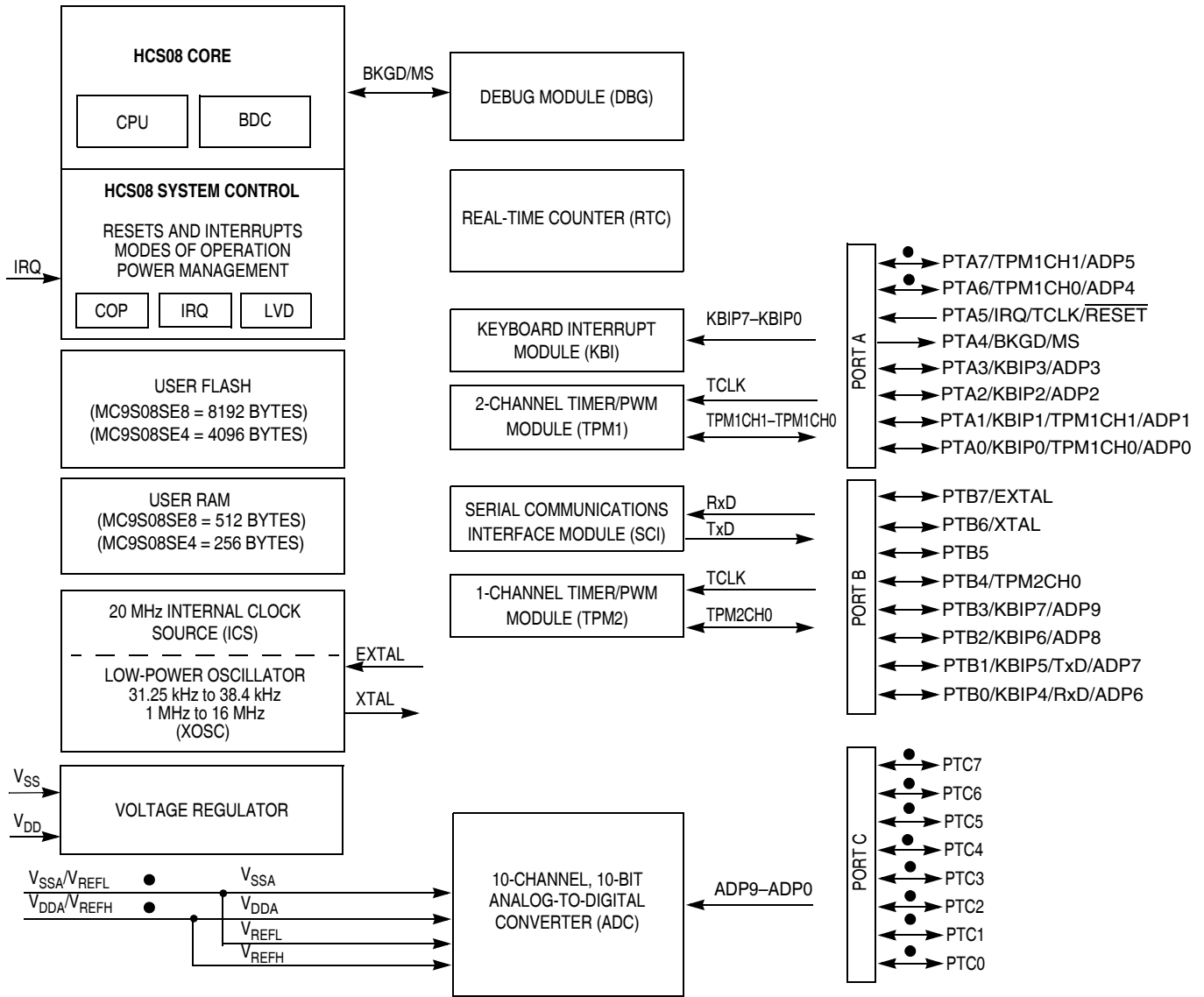

● pins not available on 16-pin package

Notes:

When PTA4 is configured as BKGD, pin is bi-directional.

For the 16-pin package: V_{SSA}/V_{REFL} and V_{DDA}/V_{REFH} are double bonded to V_{SS} and V_{DD} respectively.

Figure 1. MC9S08SE8 Series Block Diagram

2 Pin Assignments

This chapter shows the pin assignments in the packages available for the MC9S08SE8 series.

Table 1. Pin Availability by Package Pin-Count

Pin Number (Package)		<-- Lowest Priority --> Highest			
28 (SOIC/PDIP)	16 (TSSOP)	Port Pin	Alt 1	Alt 2	Alt 3
1	—	PTC5			
2	—	PTC4			
3	1	PTA5	IRQ	TCLK	RESET
4	2	PTA4		BKGD	MS
5	3				V _{DD}
6	—			V _{DDA}	V _{REFH}
7	—			V _{SSA}	V _{REFL}
8	4				V _{SS}
9	5	PTB7	EXTAL		
10	6	PTB6	XTAL		
11	7	PTB5			
12	8	PTB4		TPM2CH0	
13	—	PTC3			
14	—	PTC2			
15	—	PTC1			
16	—	PTC0			
17	9	PTB3	KBIP7		ADP9
18	10	PTB2	KBIP6		ADP8
19	11	PTB1	KBIP5	TxD	ADP7
20	12	PTB0	KBIP4	RxD	ADP6
21	—	PTA7		TPM1CH1 ¹	ADP5
22	—	PTA6		TPM1CH0 ¹	ADP4
23	13	PTA3	KBIP3		ADP3
24	14	PTA2	KBIP2		ADP2
25	15	PTA1	KBIP1	TPM1CH1 ¹	ADP1
26	16	PTA0	KBIP0	TPM1CH0 ¹	ADP0
27	—	PTC7			
28	—	PTC6			

¹ TPM1 pins can be remapped to PTA7, PTA6 and PTA1,PTA0

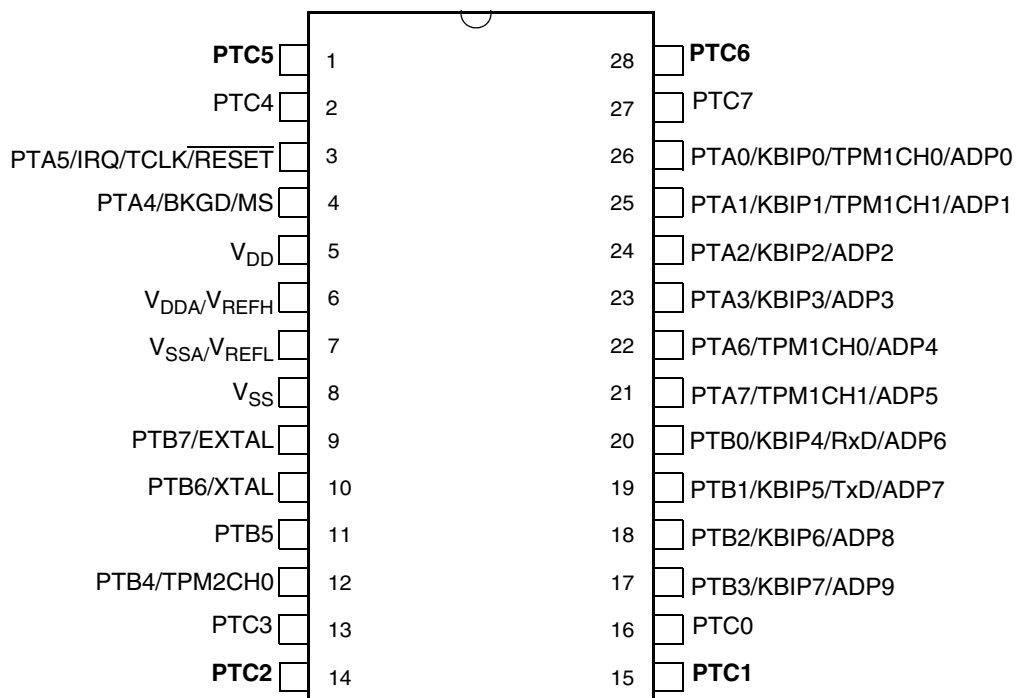

Pins in **bold** are lost in the next lower pin count package.

Figure 2. MC9S08SE8 Series in 28-Pin PDIP/SOIC Package

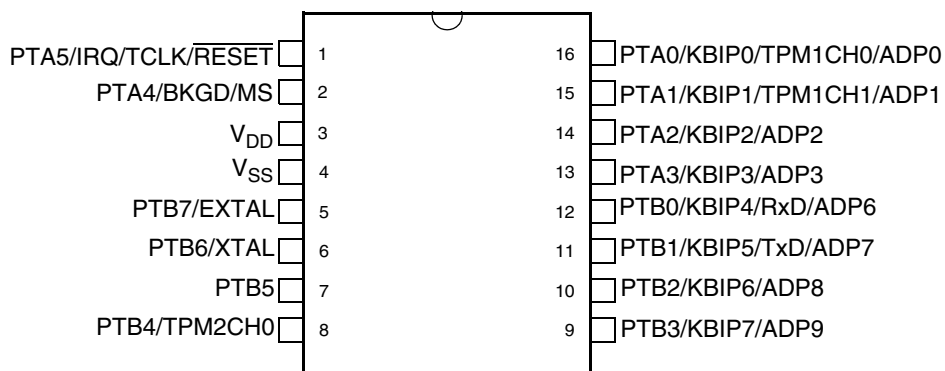

Figure 3. MC9S08SE8 in 16-Pin TSSOP Package

3 Electrical Characteristics

This chapter contains electrical and timing specifications.

3.1 Parameter Classification

The electrical parameters shown in this supplement are guaranteed by various methods. To give the customer a better understanding, the following classification is used and the parameters are tagged accordingly in the tables where appropriate:

Table 2. Parameter Classifications

P	Those parameters are guaranteed during production testing on each individual device.
C	Those parameters are achieved by the design characterization by measuring a statistically relevant sample size across process variations.
T	Those parameters are achieved by design characterization on a small sample size from typical devices under typical conditions unless otherwise noted. All values shown in the typical column are within this category.
D	Those parameters are derived mainly from simulations.

NOTE

The classification is shown in the column labeled “C” in the parameter tables where appropriate.

3.2 Absolute Maximum Ratings

Absolute maximum ratings are stress ratings only, and functional operation at the maxima is not guaranteed. Stress beyond the limits specified in [Table 3](#) may affect device reliability or cause permanent damage to the device. For functional operating conditions, refer to the remaining tables in this section.

This device contains circuitry protecting against damage due to high static voltage or electrical fields; however, it is advised that normal precautions be taken to avoid application of any voltages higher than maximum-rated voltages to this high-impedance circuit. Reliability of operation is enhanced if unused inputs are tied to an appropriate logic voltage level (for instance, either V_{SS} or V_{DD}) or the programmable pull-up resistor associated with the pin is enabled.

Table 3. Absolute Maximum Ratings

Rating	Symbol	Value	Unit
Supply voltage	V_{DD}	-0.3 to 5.8	V
Maximum current into V_{DD}	I_{DD}	120	mA
Digital input voltage	V_{In}	-0.3 to $V_{DD} + 0.3$	V
Instantaneous maximum current Single pin limit (applies to all port pins) ^{1, 2, 3}	I_D	±25	mA
Storage temperature range	T_{stg}	-55 to 150	°C

- ¹ Input must be current limited to the value specified. To determine the value of the required current-limiting resistor, calculate resistance values for positive (V_{DD}) and negative (V_{SS}) clamp voltages, then use the larger of the two resistance values.
- ² All functional non-supply pins are internally clamped to V_{SS} and V_{DD} .
- ³ Power supply must maintain regulation within operating V_{DD} range during instantaneous and operating maximum current conditions. If positive injection current ($V_{In} > V_{DD}$) is greater than I_{DD} , the injection current may flow out of V_{DD} and could result in external power supply going out of regulation. Ensure external V_{DD} load will shunt current greater than maximum injection current. This will be the greatest risk when the MCU is not consuming power. Examples are: if no system clock is present, or if the clock rate is very low (which would reduce overall power consumption).

3.3 Thermal Characteristics

This section provides information about operating temperature range, power dissipation, and package thermal resistance. Power dissipation on I/O pins is usually small compared to the power dissipation in on-chip logic and voltage regulator circuits, and it is user-determined rather than being controlled by the MCU design. To take $P_{I/O}$ into account in power calculations, determine the difference between actual pin voltage and V_{SS} or V_{DD} and multiply by the pin current for each I/O pin. Except in cases of unusually high pin current (heavy loads), the difference between pin voltage and V_{SS} or V_{DD} will be very small.

Table 4. Thermal Characteristics

Rating	Symbol	Value	Unit	
Operating temperature range (packaged)	T_A	T_L to T_H	°C	
C		-40 to 85		
V		-40 to 105		
M		-40 to 125		
Maximum junction temperature	T_{JM}	135	°C	
Thermal resistance single-layer board	θ_{JA}	28-pin SOIC	70	°C/W
		28-pin PDIP	68	
		16-pin TSSOP	129	
Thermal resistance four-layer board		28-pin SOIC	48	°C/W
		28-pin PDIP	49	
		16-pin TSSOP	85	

Electrical Characteristics

The average chip-junction temperature (T_J) in °C can be obtained from:

$$T_J = T_A + (P_D \times \theta_{JA}) \quad \text{Eqn. 1}$$

Where:

T_A = Ambient temperature, °C

θ_{JA} = Package thermal resistance, junction-to-ambient, °C/W

$P_D = P_{int} + P_{I/O}$

$P_{int} = I_{DD} \times V_{DD}$, Watts — chip internal power

$P_{I/O}$ = Power dissipation on input and output pins — user-determined

For most applications, $P_{I/O} \ll P_{int}$ and can be neglected. An approximate relationship between P_D and T_J (if $P_{I/O}$ is neglected) is:

$$P_D = K \div (T_J + 273^\circ\text{C}) \quad \text{Eqn. 2}$$

Solving [Equation 1](#) and [Equation 2](#) for K gives:

$$K = P_D \times (T_A + 273^\circ\text{C}) + \theta_{JA} \times (P_D)^2 \quad \text{Eqn. 3}$$

Where K is a constant pertaining to the particular part. K can be determined from [Equation 3](#) by measuring P_D (at equilibrium) for a known T_A . Using this value of K, the values of P_D and T_J can be obtained by solving [Equation 1](#) and [Equation 2](#) iteratively for any value of T_A .

3.4 ESD Protection and Latch-Up Immunity

Although damage from electrostatic discharge (ESD) is much less common on these devices than on early CMOS circuits, normal handling precautions should be used to avoid exposure to static discharge. Qualification tests are performed to ensure that these devices can withstand exposure to reasonable levels of static without suffering any permanent damage.

During the device qualification ESD stresses were performed for the human body model (HBM), the machine model (MM) and the charge device model (CDM).

A device is defined as a failure if after exposure to ESD pulses the device no longer meets the device specification. Complete DC parametric and functional testing is performed per the applicable device specification at room temperature followed by hot temperature, unless specified otherwise in the device specification.

Table 5. ESD and Latch-up Test Conditions

Model	Description	Symbol	Value	Unit
Human body	Series resistance	R1	1500	Ω
	Storage capacitance	C	100	pF
	Number of pulses per pin	—	3	—
Machine	Series resistance	R1	0	Ω
	Storage capacitance	C	200	pF
	Number of pulses per pin	—	3	—

Table 5. ESD and Latch-up Test Conditions (continued)

Model	Description	Symbol	Value	Unit
Latch-up	Minimum input voltage limit	—	-2.5	V
	Maximum input voltage limit	—	7.5	V

Table 6. ESD and Latch-up Protection Characteristics

No.	Rating ¹	Symbol	Min	Max	Unit
1	Human body model (HBM)	V_{HBM}	± 2000	—	V
2	Machine model (MM)	V_{MM}	± 200	—	V
3	Charge device model (CDM)	V_{CDM}	± 500	—	V
4	Latch-up current at $T_A = 125^\circ\text{C}$	I_{LAT}	± 100	—	mA

¹ Parameter is achieved by design characterization on a small sample size from typical devices under typical conditions unless otherwise noted.

3.5 DC Characteristics

This section includes information about power supply requirements and I/O pin characteristics.

Table 7. DC Characteristics

Num	C	Parameter	Symbol	Min	Typical ¹	Max	Unit
1	—	Operating voltage	—	2.7	—	5.5	V
2	P	Output high voltage — Low drive (PTxDSn = 0) 5 V, $I_{Load} = -2$ mA 3 V, $I_{Load} = -0.6$ mA 5 V, $I_{Load} = -0.4$ mA 3 V, $I_{Load} = -0.24$ mA	V_{OH}	$V_{DD} - 1.5$	—	—	V
		$V_{DD} - 1.5$		—	—		
2	P	Output high voltage — High drive (PTxDSn = 1) 5 V, $I_{Load} = -10$ mA 3 V, $I_{Load} = -3$ mA 5 V, $I_{Load} = -2$ mA 3 V, $I_{Load} = -0.4$ mA	V_{OH}	$V_{DD} - 1.5$	—	—	V
		$V_{DD} - 1.5$		—	—		
3	P	Output low voltage — Low drive (PTxDSn = 0) 5 V, $I_{Load} = 2$ mA 3 V, $I_{Load} = 0.6$ mA 5 V, $I_{Load} = 0.4$ mA 3 V, $I_{Load} = 0.24$ mA	V_{OL}	1.5	—	—	V
		1.5		—	—		
3	P	Output low voltage — High drive (PTxDSn = 1) 5 V, $I_{Load} = 10$ mA 3 V, $I_{Load} = 3$ mA 5 V, $I_{Load} = 2$ mA 3 V, $I_{Load} = 0.4$ mA	V_{OL}	0.8	—	—	V
		0.8		—	—		
4	P	Output high current — Max total I_{OH} for all ports 5 V 3 V	I_{OHT}	—	—	100 60	mA

Table 7. DC Characteristics (continued)

Num	C	Parameter	Symbol	Min	Typical ¹	Max	Unit
5	P	Output low current — Max total I _{OL} for all ports 5 V 3 V	I _{OLT}	— —	— —	100 60	mA
6	P	Input high voltage; all digital inputs	V _{IH}	0.65 × V _{DD}	—	—	V
7	P	Input low voltage; all digital inputs	V _{IL}	—	—	0.35 × V _{DD}	
8	P	Input hysteresis; all digital inputs	V _{hys}	0.06 × V _{DD}	—	—	mV
9	C	Input leakage current; input only pins ²	I _{IN}	—	0.1	1	μA
10	P	High impedance (off-state) leakage current ²	I _{OZ}	—	0.1	1	μA
11	C	Total leakage combined for all inputs and Hi-Z pins — All input only and I/O ²	I _{OZTOT}	—	—	2	μA
12	P	Internal pullup resistors ³	R _{PU}	20	45	65	kΩ
13	P	Internal pulldown resistors ⁴	R _{PD}	20	45	65	kΩ
14	D	DC injection current ^{5, 6, 7} V _{IN} < V _{SS} , V _{IN} > V _{DD} Single pin limit Total MCU limit, includes sum of all stressed pins	I _{IC}	-0.2 -5	— —	0.2 5	mA
15	C	Input capacitance; all non-supply pins	C _{In}	—	—	8	pF
16	C	RAM retention voltage	V _{RAM}	0.6	1.0	—	V
17	P	POR re-arm voltage ⁸	V _{POR}	0.9	1.4	2.0	V
18	D	POR re-arm time	t _{POR}	10	—	—	μs
19	P	Low-voltage detection threshold — high range V _{DD} falling V _{DD} rising	V _{LVD1}	3.9 4.0	4.0 4.1	4.1 4.2	V
20	P	Low-voltage detection threshold — low range V _{DD} falling V _{DD} rising	V _{LVD0}	2.48 2.54	2.56 2.62	2.64 2.70	V
21	C	Low-voltage warning threshold — high range 1 V _{DD} falling V _{DD} rising	V _{LVW3}	4.5 4.6	4.6 4.7	4.7 4.8	V
22	P	Low-voltage warning threshold — high range 0 V _{DD} falling V _{DD} rising	V _{LVW2}	4.2 4.3	4.3 4.4	4.4 4.5	V
23	P	Low-voltage warning threshold low range 1 V _{DD} falling V _{DD} rising	V _{LVW1}	2.84 2.90	2.92 2.98	3.00 3.06	V
24	C	Low-voltage warning threshold — low range 0 V _{DD} falling V _{DD} rising	V _{LVW0}	2.66 2.72	2.74 2.80	2.82 2.88	V

Table 7. DC Characteristics (continued)

Num	C	Parameter	Symbol	Min	Typical ¹	Max	Unit
25	T	Low-voltage inhibit reset/recover hysteresis	V_{hys}	5 V	—	100	mV
				3 V	—	60	
26	P	Bandgap voltage reference ⁹	V_{BG}	1.18	1.20	1.21	V

¹ Typical values are measured at 25 °C. Characterized, not tested.

² Measured with $V_{In} = V_{DD}$ or V_{SS} .

³ Measured with $V_{In} = V_{SS}$.

⁴ Measured with $V_{In} = V_{DD}$.

⁵ All functional non-supply pins are internally clamped to V_{SS} and V_{DD} .

⁶ Input must be current-limited to the value specified. To determine the value of the required current-limiting resistor, calculate resistance values for positive and negative clamp voltages, then use the larger of the two values.

⁷ Power supply must maintain regulation within operating V_{DD} range during instantaneous and operating maximum current conditions. If positive injection current ($V_{In} > V_{DD}$) is greater than I_{DD} , the injection current may flow out of V_{DD} and could result in external power supply going out of regulation. Ensure external V_{DD} load will shunt current greater than maximum injection current. This will be the greatest risk when the MCU is not consuming power. Examples are: if no system clock is present, or if clock rate is very low (which would reduce overall power consumption).

⁸ Maximum is highest voltage that POR is guaranteed.

⁹ Factory trimmed at $V_{DD} = 5.0$ V, Temp = 25 °C.

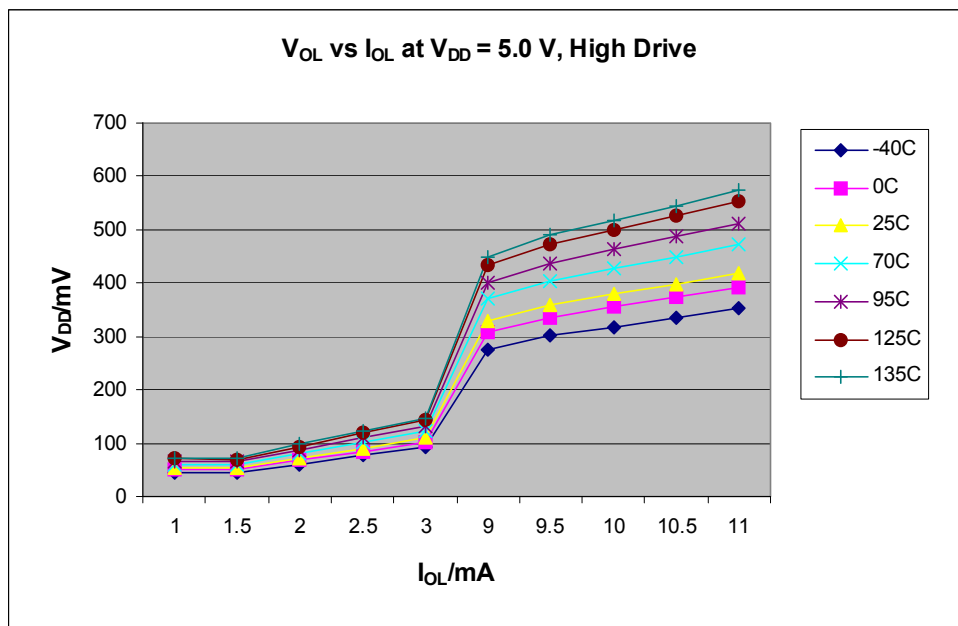

Figure 4. Typical V_{OL} vs. I_{OL} for High Drive Enabled Pad (V_{DD} = 5 V)

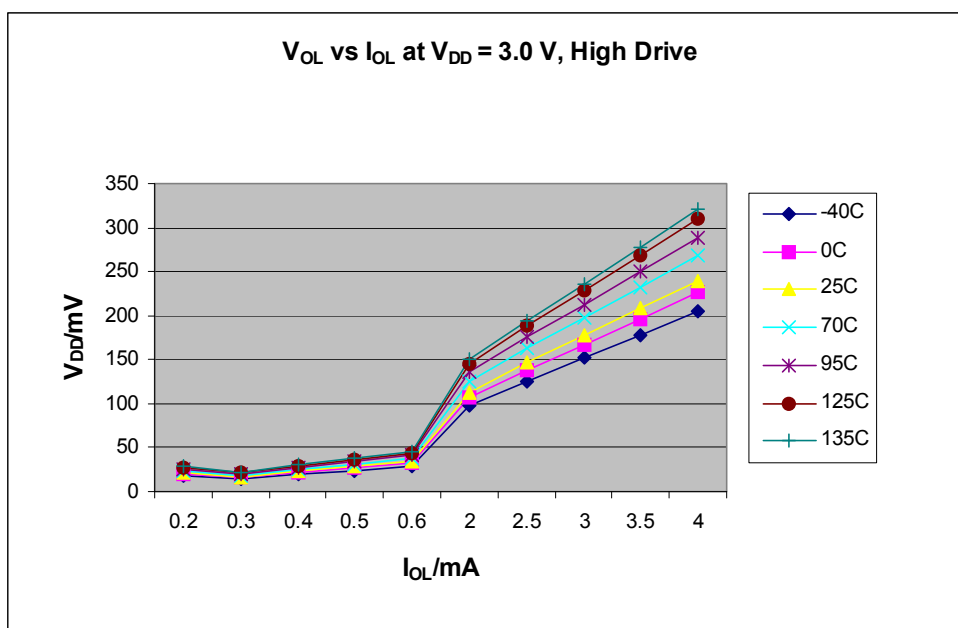

Figure 5. Typical V_{OL} vs. I_{OL} for High Drive Enabled Pad (V_{DD} = 3 V)

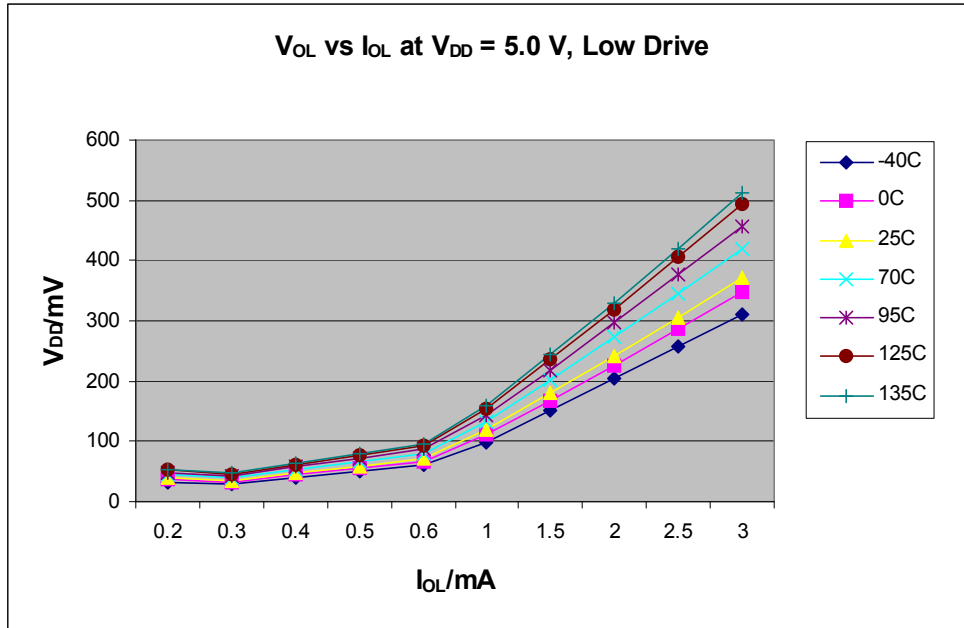

Figure 6. Typical V_{OL} vs. I_{OL} for Low Drive Enabled Pad ($V_{DD} = 5$ V)

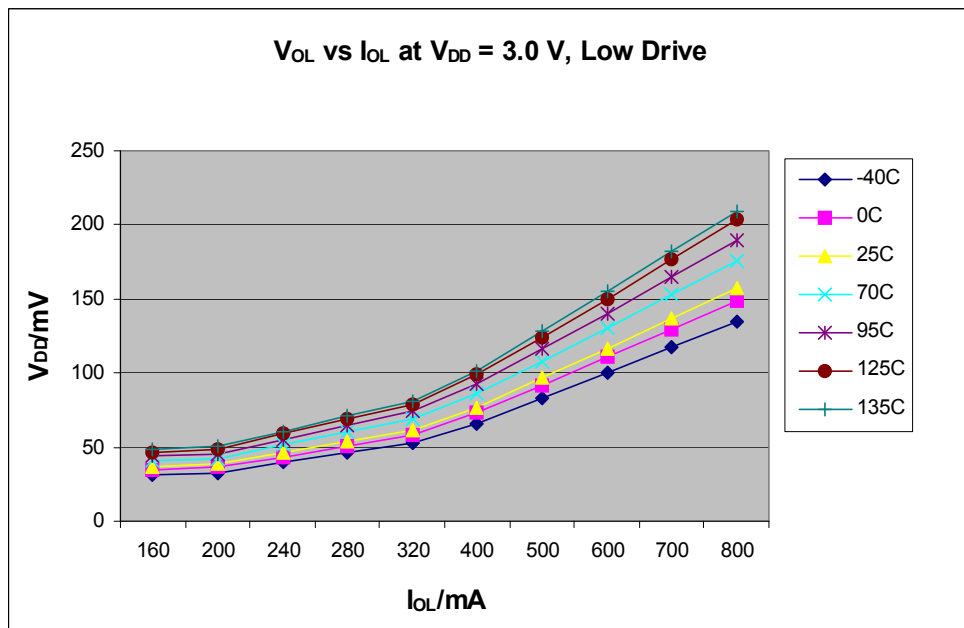

Figure 7. Typical V_{OL} vs. I_{OL} for Low Drive Enabled Pad ($V_{DD} = 3$ V)

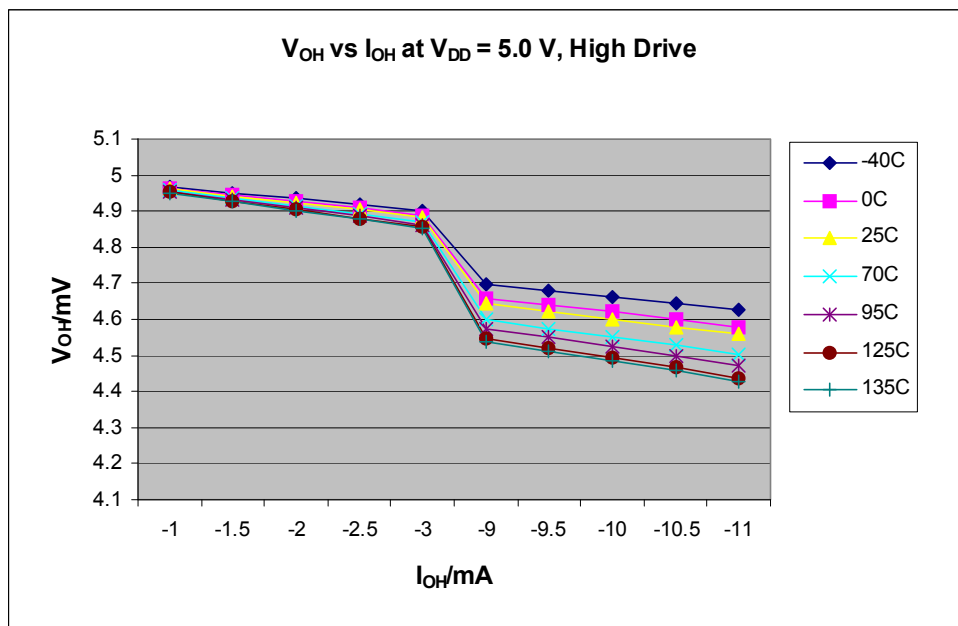

Figure 8. Typical V_{OH} vs. I_{OH} for High Drive Enabled Pad (V_{DD} = 5 V)

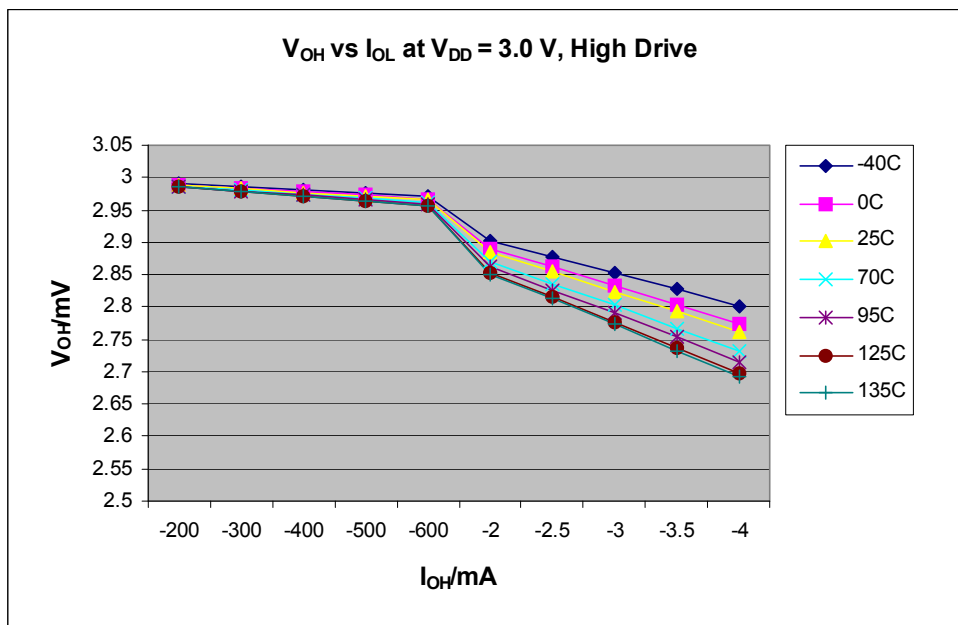

Figure 9. Typical V_{OH} vs. I_{OH} for High Drive Enabled Pad (V_{DD} = 3 V)

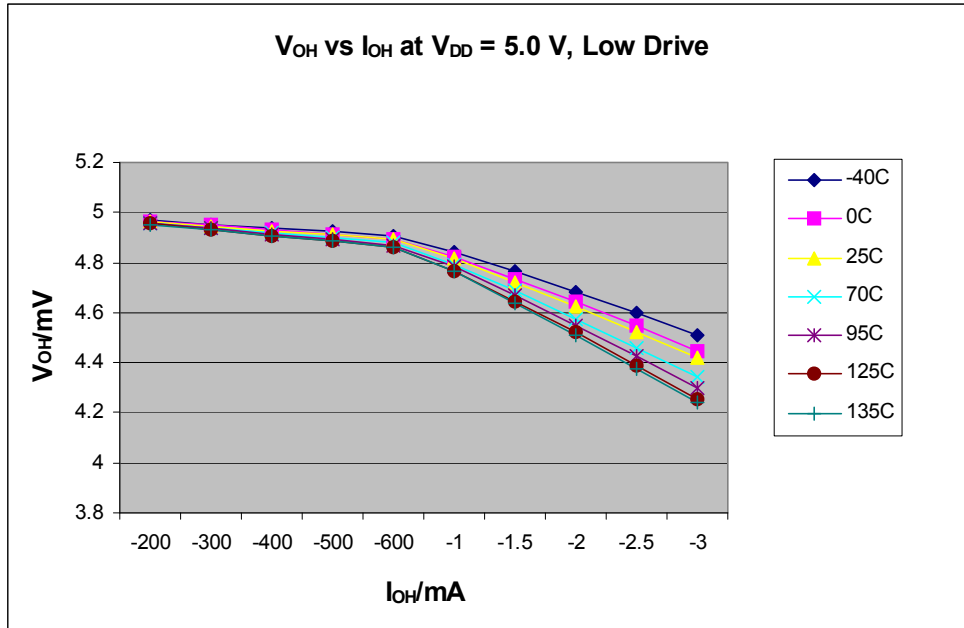

Figure 10. Typical V_{OH} vs. I_{OH} for Low Drive Enabled Pad (V_{DD} = 5 V)

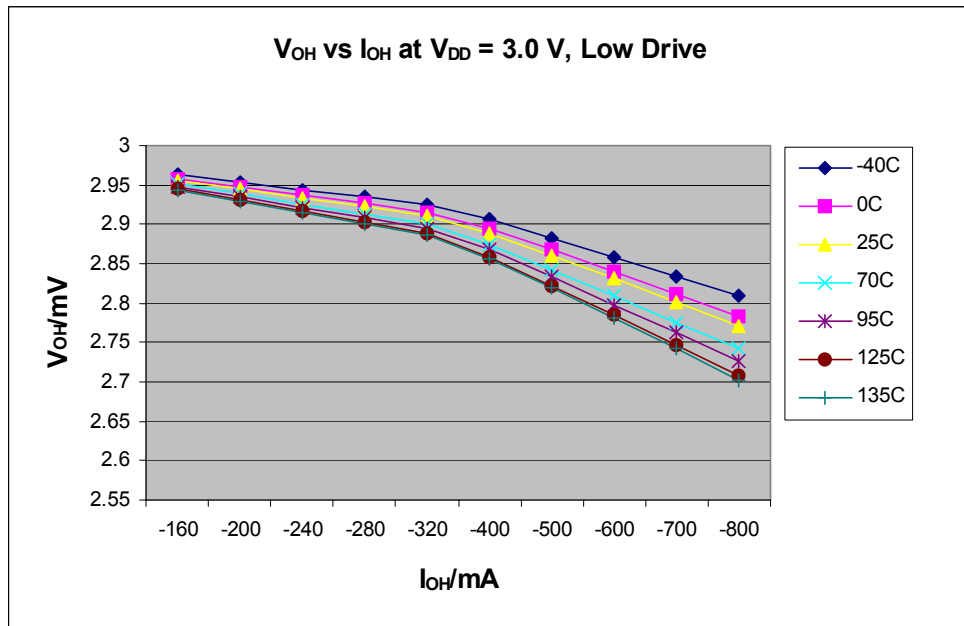

Figure 11. Typical V_{OH} vs. I_{OH} for Low Drive Enabled Pad (V_{DD} = 3 V)

3.6 Supply Current Characteristics

This section includes information about power supply current in various operating modes.

Table 8. Supply Current Characteristics

Num	C	Parameter	Symbol	V _{DD} (V)	Typical ¹	Max	Unit	Temp (°C)
1	C	Run supply current ² measured at (CPU clock = 4 MHz, f _{Bus} = 2 MHz)	R _I DD	5	2.4	2.72	mA	-40 to 125
				3	2.18	2.26		
2	P	Run supply current ² measured at (CPU clock = 20 MHz, f _{Bus} = 10 MHz)	R _I DD	5	6.35	7.29	mA	-40 to 125
				3	5.79	6.42		
3	P	Wait supply current ² measured at f _{Bus} = 2 MHz	W _I DD	5	1.4	1.56	mA	-40 to 125
				3	1.36	1.53		
4	P	Stop2 mode supply current	S2 _I DD	5	1.4	19 28 45.8	μA	-40 to 85 -40 to 105 -40 to 125
				3	1.3	15 22 37.2		
5	P	Stop3 mode supply current	S3 _I DD	5	1.61	23 43 76.1	μA	-40 to 85 -40 to 105 -40 to 125
				3	1.44	19 38 66.4		
6	P	RTC adder to stop2 or stop3 ³	S23 _I DDRTI	5	300	500 500	nA	-40 to 85 -40 to 125
				3	300	500 500		
7	C	LVD adder to stop3 (LVDE = LVDSE = 1)	S3 _I DDLVD	5	122	180	μA	-40 to 125
				3	110	160		
8	C	Adder to stop3 for oscillator enabled ⁴ (OSCSTEN = 1)	S3 _I DDOSC	5,3	5	8	μA	-40 to 125

¹ Typical values are based on characterization data at 25 °C unless otherwise stated. See [Figure 12](#) through [Figure 13](#) for typical curves across voltage/temperature.

² All modules except ADC active, ICS configured for FBE, and does not include any dc loads on port pins.

³ Most customers are expected to find that auto-wakeup from stop2 or stop3 can be used instead of the higher current wait mode. Wait mode typical is 220 μA at 5 V with f_{Bus} = 1 MHz.

⁴ Values given under the following conditions: low range operation (RANGE = 0) with a 32.768 kHz crystal and low power mode (HGO = 0).

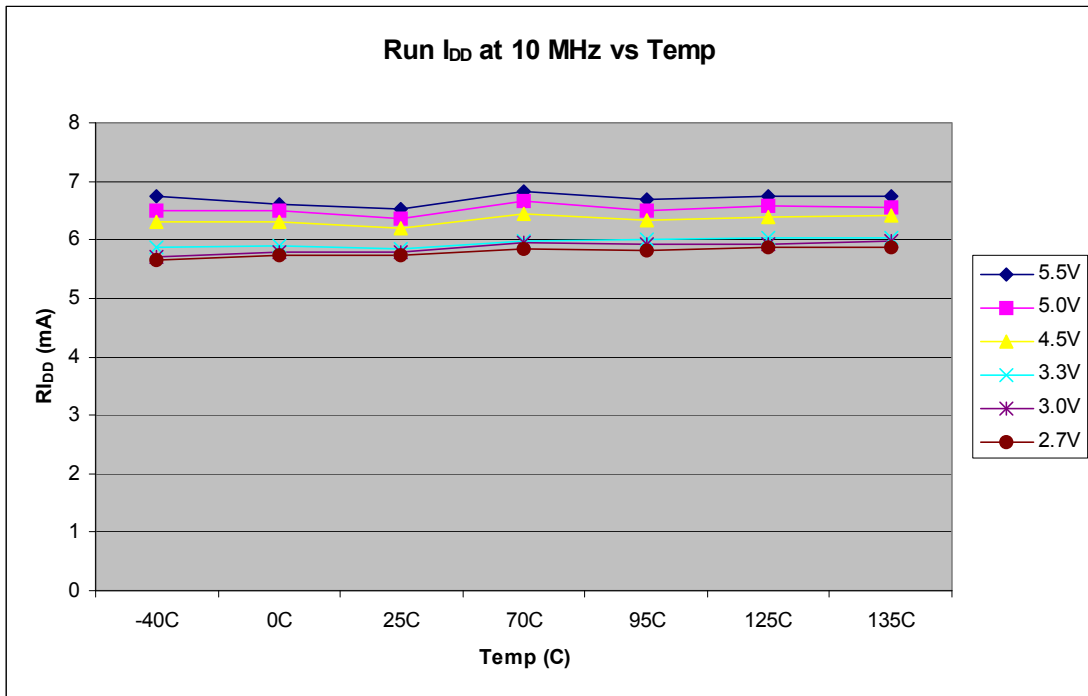

Figure 12. Typical Run I_{DD} Curves

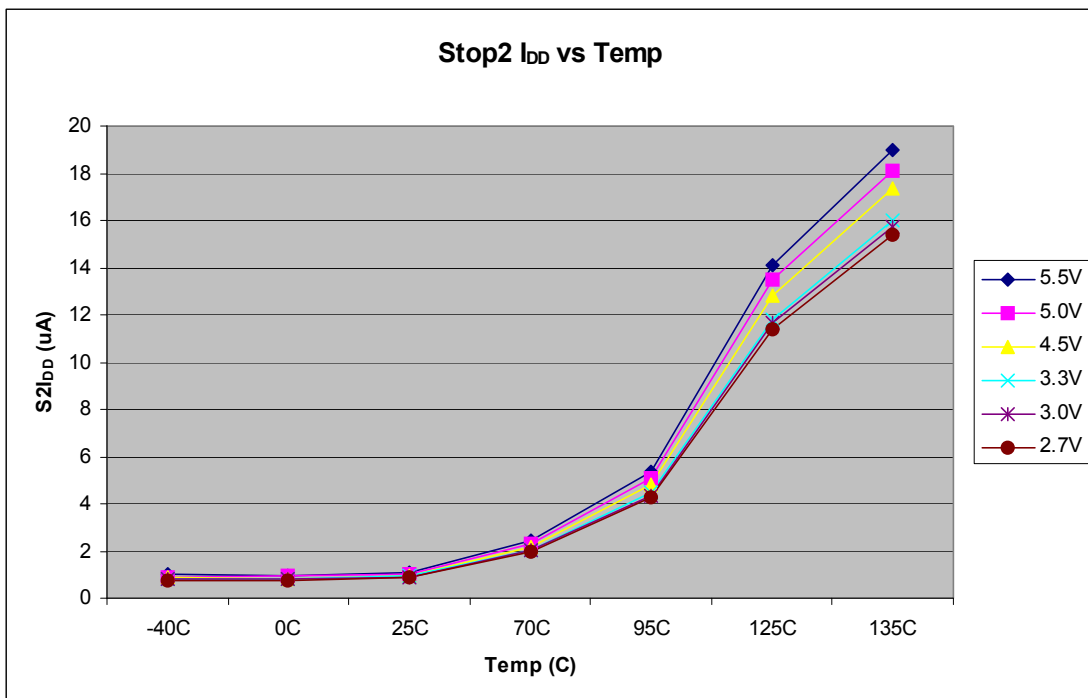

Figure 13. Typical Stop2 I_{DD} Curves

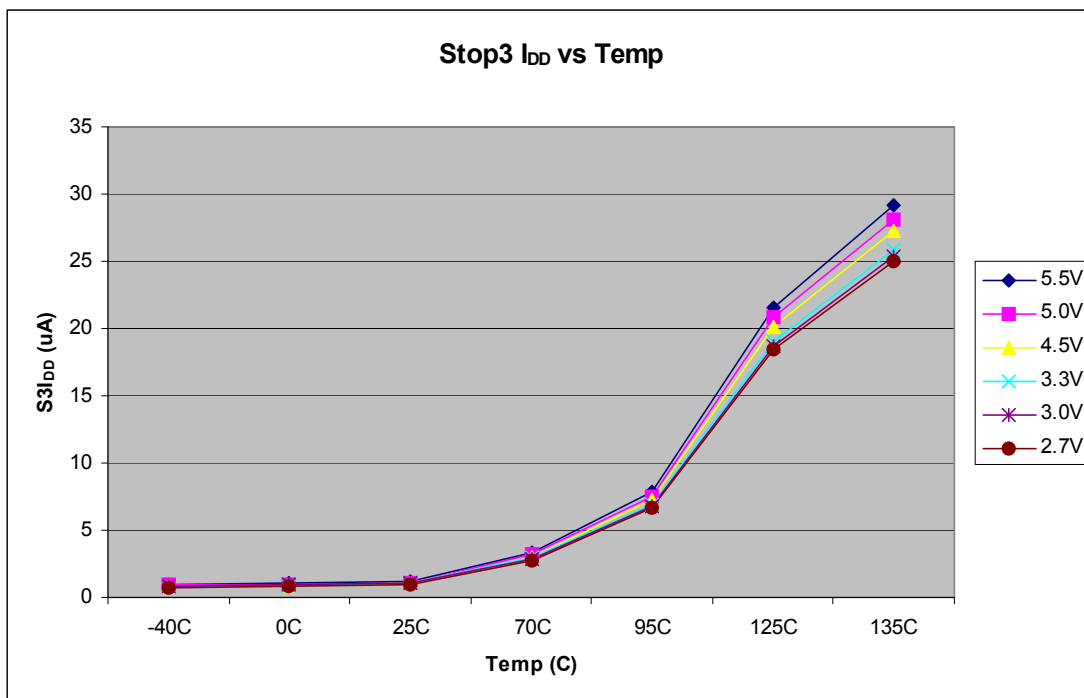

Figure 14. Typical Stop3 I_{DD} Curves

3.7 External Oscillator (XOSC) Characteristics

Table 9. Oscillator electrical specifications (Temperature Range = -40 to 125°C Ambient)

Num	C	Characteristic	Symbol	Min.	Typical ¹	Max.	Unit	
1	C	Oscillator crystal or resonator (EREFS = 1, ERCLKEN = 1)						
		Low range (RANGE = 0)	f _{lo}	32	—	38.4	kHz	
		High range (RANGE = 1), high gain (HGO = 1) ²	f _{hi-hgo}	1	—	16	MHz	
		High range (RANGE = 1), low power (HGO = 0) ²	f _{hi-lp}	1	—	8	MHz	
2	—	Load capacitors	C ₁ , C ₂	See crystal or resonator manufacturer's recommendation				
3	—	Feedback resistor	R _F	—	10	—	MΩ	
		Low range (32 kHz to 100 kHz)						1
4	—	Series resistor	R _S	—	0	—	kΩ	
		Low range, low gain (RANGE = 0, HGO = 0)						100
		Low range, high gain (RANGE = 0, HGO = 1)						0
	High range, low gain (RANGE = 1, HGO = 0)	0						
	High range, high gain (RANGE = 1, HGO = 1)	0						
		≥ 8 MHz	0	0				
		4 MHz	0	10				
		1 MHz	0	20				

Table 9. Oscillator electrical specifications (Temperature Range = -40 to 125°C Ambient)

Num	C	Characteristic	Symbol	Min.	Typical ¹	Max.	Unit
5	T	Crystal start-up time ³					
		Low range, low gain (RANGE = 0, HGO = 0)	$t_{CSTL-LP}$	—	200	—	ms
		Low range, high gain (RANGE = 0, HGO = 1)	$t_{CSTH-HGO}$	—	400	—	
		High range, low gain (RANGE = 1, HGO = 0) ⁴	$t_{CSTH-LP}$	—	5	—	
High range, high gain (RANGE = 1, HGO = 1) ⁴	$t_{CSTH-HGO}$	—	15	—			
6	T	Square wave input clock frequency (EREFS = 0, ERCLKEN = 1) FEE or FBE mode ²	f_{extal}	0.03125	—	20	MHz
		FBELP mode		0	—	20	MHz

¹ Typical column was characterized at 5.0 V, 25 °C or is recommended value.

² The input clock source must be divided using RDIV to within the range of 31.25 kHz to 39.0625 kHz.

³ This parameter is characterized and not tested on each device. Proper PC board layout procedures must be followed to achieve specifications. This data will vary based upon the crystal manufacturer and board design. The crystal should be characterized by the crystal manufacturer.

⁴ 4 MHz crystal.

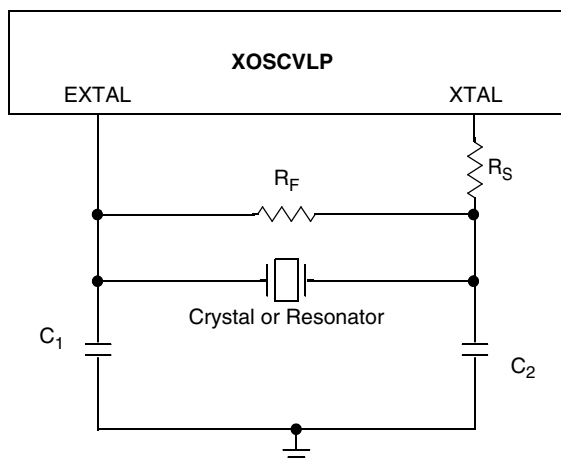

Figure 15. Typical Crystal or Resonator Circuit: High Range and Low Range/High Gain

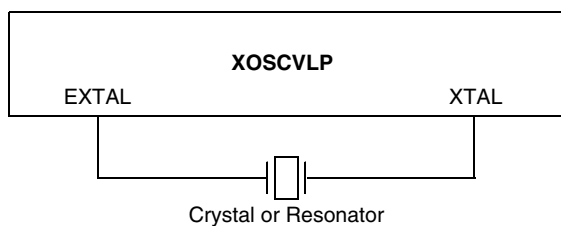

Figure 16. Typical Crystal or Resonator Circuit: Low Range/Low Power

3.8 Internal Clock Source (ICS) Characteristics

Table 10. ICS Frequency Specifications (Temperature Range = -40 to 85°C Ambient)

Num	C	Characteristic	Symbol	Min.	Typical ¹	Max.	Unit
1	P	Average internal reference frequency — factory trimmed at V _{DD} = 5 V and temperature = 25 °C	f _{int_t}	—	39.0625	—	kHz
2	P	Internal reference frequency — user trimmed	f _{int_ut}	31.25	—	39.06	kHz
3	T	Internal reference start-up time	t _{IRST}	—	60	100	μs
4	D	DCO output frequency range — trimmed ² Low range (DRS = 00)	f _{dco_t}	16	—	20	MHz
5	D	DCO output frequency ² Reference = 32768 Hz and DMX32 = 1	f _{dco_DM32}	—	59.77	—	MHz
6	C	Resolution of trimmed DCO output frequency at fixed voltage and temperature (using FTRIM)	Δf _{dco_res_t}	—	±0.1	±0.2	%f _{dco}
7	C	Resolution of trimmed DCO output frequency at fixed voltage and temperature (not using FTRIM)	Δf _{dco_res_t}	—	± 0.2	± 0.4	%f _{dco}
8	C	Total deviation of DCO output from trimmed frequency ³ Over full voltage and temperature range Over fixed voltage and temperature range of 0 to 70 °C	Δf _{dco_t}	—	-1.0 to 0.5 ±0.5	± 2 ± 1	%f _{dco}
10	C	FLL acquisition time ⁴	t _{Acquire}	—	—	1	ms
11	C	Long term jitter of DCO output clock (averaged over 2-ms interval) ⁵	C _{Jitter}	—	0.02	0.2	%f _{dco}

¹ Data in Typical column was characterized at 3.0 V, 25 °C or is typical recommended value.

² The resulting bus clock frequency should not exceed the maximum specified bus clock frequency of the device.

³ This parameter is characterized and not tested on each device.

⁴ This specification applies to any time the FLL reference source or reference divider is changed, trim value changed or changing from FLL disabled (FBELP, FBILP) to FLL enabled (FEI, FEE, FBE, FBI). If a crystal/resonator is being used as the reference, this specification assumes it is already running.

⁵ Jitter is the average deviation from the programmed frequency measured over the specified interval at maximum f_{BUS}. Measurements are made with the device powered by filtered supplies and clocked by a stable external clock signal. Noise injected into the FLL circuitry via V_{DD} and V_{SS} and variation in crystal oscillator frequency increase the C_{Jitter} percentage for a given interval.

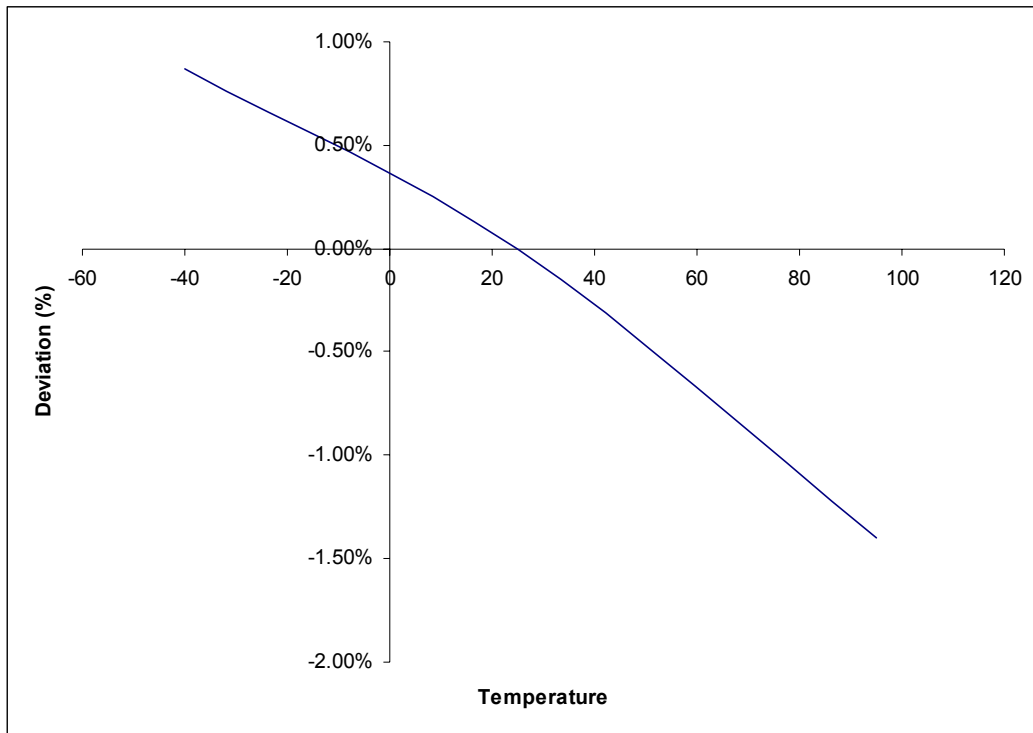

Figure 17. Deviation of DCO Output from Trimmed Frequency (20 MHz, 3.0 V)

3.9 ADC Characteristics

Table 11. 10-Bit ADC Operating Conditions

Characteristic	Conditions	Symb	Min	Typ ¹	Max	Unit	Comment
Supply voltage	Absolute	V_{DDA}	2.7	—	5.5	V	
	Delta to V_{DD} ($V_{DD} - V_{DDA}$) ²	ΔV_{DDA}	-100	0	100	mV	
Ground voltage	Delta to V_{SS} ($V_{SS} - V_{SSA}$) ²	ΔV_{SSA}	-100	0	100	mV	
Input voltage		V_{ADIN}	V_{REFL}	—	V_{REFH}	V	
Input capacitance		C_{ADIN}	—	4.5	5.5	pF	
Input resistance		R_{ADIN}	—	3	5	k Ω	
Analog source resistance	10-bit mode $f_{ADCK} > 4\text{MHz}$ $f_{ADCK} < 4\text{MHz}$	R_{AS}	—	—	5	k Ω	External to MCU
	8-bit mode (all valid f_{ADCK})		—	—	10		
ADC conversion clock frequency	High speed (ADLPC = 0)	f_{ADCK}	0.4	—	8.0	MHz	
	Low power (ADLPC = 1)		0.4	—	4.0		

Electrical Characteristics

- ¹ Typical values assume $V_{DDA} = 5.0\text{ V}$, $\text{Temp} = 25\text{ }^\circ\text{C}$, $f_{\text{ADCK}} = 1.0\text{ MHz}$ unless otherwise stated. Typical values are for reference only and are not tested in production.
- ² DC potential difference.

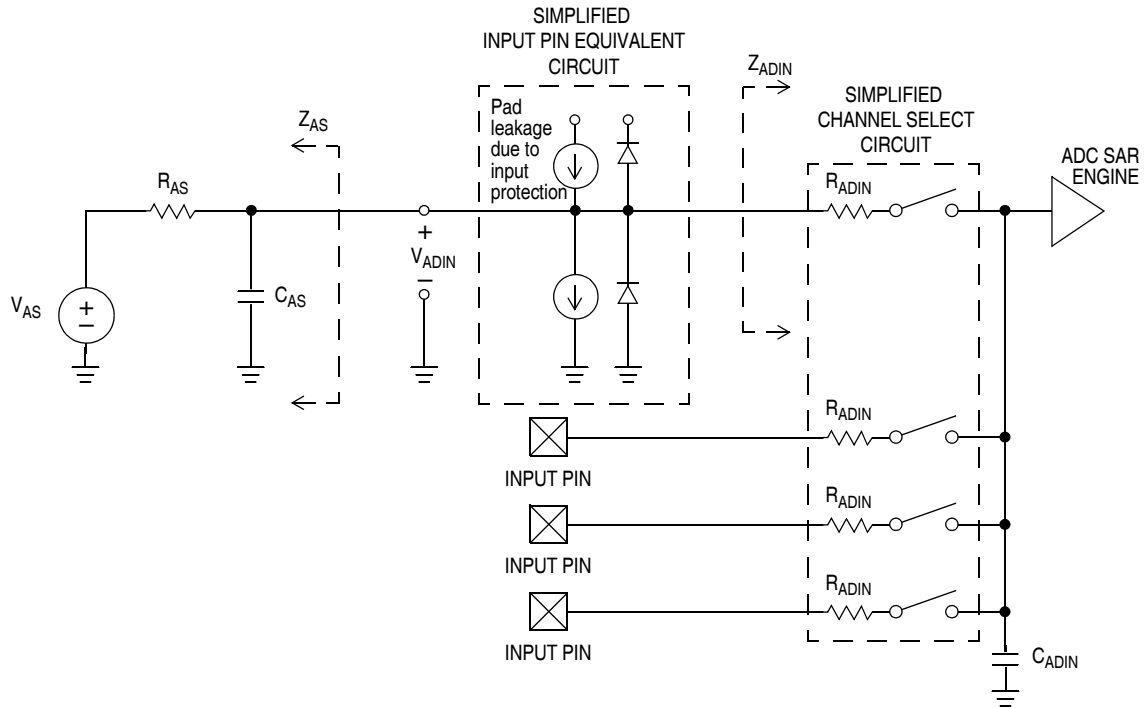

Figure 18. ADC Input Impedance Equivalency Diagram

Table 12. 10-Bit ADC Characteristics ($V_{\text{REFH}} = V_{\text{DDA}}$, $V_{\text{REFL}} = V_{\text{SSA}}$)

Characteristic	Conditions	C	Symb	Min	Typ ¹	Max	Unit	Comment
Supply Current ADLPC = 1 ADLSMP = 1 ADCO = 1		T	I_{DDA}	—	133	—	μA	
Supply Current ADLPC = 1 ADLSMP = 0 ADCO = 1		T	I_{DDA}	—	218	—	μA	
Supply Current ADLPC = 0 ADLSMP = 1 ADCO = 1		T	I_{DDA}	—	327	—	μA	
Supply Current ADLPC = 0 ADLSMP = 0 ADCO = 1		D	I_{DDA}	—	0.582	1	mA	
Supply Current	Stop, Reset, Module Off	D	I_{DDA}	—	0.011	1	μA	

Table 12. 10-Bit ADC Characteristics ($V_{REFH} = V_{DDA}$, $V_{REFL} = V_{SSA}$) (continued)

Characteristic	Conditions	C	Symb	Min	Typ ¹	Max	Unit	Comment
ADC Asynchronous Clock Source	High Speed (ADLPC = 0)	D	f_{ADACK}	2	3.3	5	MHz	$t_{ADACK} = 1/f_{ADACK}$
	Low Power (ADLPC = 1)			1.25	2	3.3		
Conversion Time (Including sample time)	Short Sample (ADLSMP = 0)	D	t_{ADC}	—	20	—	ADCK cycles	See SE8 reference manual for conversion time variances
	Long Sample (ADLSMP = 1)			—	40	—		
Sample Time	Short Sample (ADLSMP = 0)	D	t_{ADS}	—	3.5	—	ADCK cycles	
	Long Sample (ADLSMP = 1)			—	23.5	—		
Temp Sensor Slope	−40°C– 25°C	D	m	—	3.266	—	mV/°C	
	25°C– 125°C			—	3.638	—		
Temp Sensor Voltage	25°C	D	V_{TEMP25}	—	1.396	—	mV	
Characteristics for 28-pin packages only								
Total Unadjusted Error	10-bit mode	P	E_{TUE}	—	±1	±2.5	LSB ³	Includes quantization
	8-bit mode	P		—	±0.5	±1.0		
Differential Non-Linearity	10-bit mode ²	P	DNL	—	±0.5	±1.0	LSB ³	
	8-bit mode ³	P		—	±0.3	±0.5		
Integral Non-Linearity	10-bit mode	T	INL	—	±0.5	±1.0	LSB ³	
	8-bit mode	T		—	±0.3	±0.5		
Zero-Scale Error	10-bit mode	P	E_{ZS}	—	±0.5	±1.5	LSB ³	$V_{ADIN} = V_{SSA}$
	8-bit mode	P		—	±0.5	±0.5		
Full-Scale Error	10-bit mode	T	E_{FS}	—	±0.5	±1	LSB ³	$V_{ADIN} = V_{DDA}$
	8-bit mode	T		—	±0.5	±0.5		
Quantization Error	10-bit mode	D	E_Q	—	—	±0.5	LSB ³	
	8-bit mode			—	—	±0.5		
Input Leakage Error	10-bit mode	D	E_{IL}	—	±0.2	±2.5	LSB ³	Pad leakage ^{4*} R_{AS}
	8-bit mode			—	±0.1	±1		
Characteristics for 16-pin package only								
Total Unadjusted Error	10-bit mode	P	E_{TUE}	—	±1.5	±3.5	LSB ³	Includes quantization
	8-bit mode	P		—	±0.7	±1.5		

Electrical Characteristics

Table 12. 10-Bit ADC Characteristics ($V_{REFH} = V_{DDA}$, $V_{REFL} = V_{SSA}$) (continued)

Characteristic	Conditions	C	Symb	Min	Typ ¹	Max	Unit	Comment
Differential Non-Linearity	10-bit mode ³	P	DNL	—	±0.5	±1.0	LSB ³	
	8-bit mode ³	P		—	±0.3	±0.5		
Integral Non-Linearity	10-bit mode	T	INL	—	±0.5	±1.0	LSB ³	
	8-bit mode	T		—	±0.3	±0.5		
Zero-Scale Error	10-bit mode	P	E_{ZS}	—	±1.5	±2.1	LSB ³	$V_{ADIN} = V_{SSA}$
	8-bit mode	P		—	±0.5	±0.7		
Full-Scale Error	10-bit mode	T	E_{FS}	—	±1	±1.5	LSB ³	$V_{ADIN} = V_{DDA}$
	8-bit mode	T		—	±0.5	±0.5		
Quantization Error	10-bit mode	D	E_Q	—	—	±0.5	LSB ³	
	8-bit mode			—	—	±0.5		
Input Leakage Error	10-bit mode	D	E_{IL}	—	±0.2	±2.5	LSB ³	Padleakage ^{4*} R_{AS}
	8-bit mode			—	±0.1	±1		

¹ Typical values assume $V_{DDA} = 5.0$ V, Temp = 25 °C, $f_{ADCK} = 1.0$ MHz unless otherwise stated. Typical values are for reference only and are not tested in production.

² Monotonicity and No-Missing-Codes guaranteed in 10-bit and 8-bit modes

³ $1 \text{ LSB} = (V_{REFH} - V_{REFL})/2^N$

⁴ Based on input pad leakage current. Refer to pad electricals.

3.10 AC Characteristics

This section describes ac timing characteristics for each peripheral system.

3.10.1 Control Timing

Table 13. Control Timing

Num	C	Rating	Symbol	Min	Typical ¹	Max	Unit
1	D	Bus frequency ($t_{cyc} = 1/f_{Bus}$)	f_{Bus}	DC	—	10	MHz
2	D	Internal low power oscillator period	t_{LPO}	700	—	1300	μs
3	D	External reset pulse width ²	t_{extrst}	100	—	—	ns
4	D	Reset low drive ³	t_{rstdrv}	$34 \times t_{cyc}$	—	—	ns
5	D	BKGD/MS setup time after issuing background debug force reset to enter user or BDM modes	t_{MSSU}	500	—	—	ns
6	D	BKGD/MS hold time after issuing background debug force reset to enter user or BDM modes ⁴	t_{MSH}	100	—	—	μs
7	D	IRQ pulse width Asynchronous path ² Synchronous path ⁵	t_{LIH}, t_{IHIL}	100 $1.5 \times t_{cyc}$	—	—	ns
8	D	Pin interrupt pulse width Asynchronous path ² Synchronous path ⁵	t_{LIH}, t_{IHIL}	100 $1.5 \times t_{cyc}$	—	—	ns
9	C	Port rise and fall time — Low output drive (PTxDS = 0) (load = 50 pF) ⁶ Slew rate control disabled (PTxSE = 0) Slew rate control enabled (PTxSE = 1)	t_{Rise}, t_{Fall}	—	40 75	—	ns
		Port rise and fall time — High output drive (PTxDS = 1) (load = 50 pF) Slew rate control disabled (PTxSE = 0) Slew rate control enabled (PTxSE = 1)	t_{Rise}, t_{Fall}	—	11 35	—	ns

¹ Typical values are based on characterization data at $V_{DD} = 5.0$ V, 25 °C unless otherwise stated.

² This is the shortest pulse that is guaranteed to be recognized as a reset pin request. Shorter pulses are not guaranteed to override reset requests from internal sources.

³ When any reset is initiated, internal circuitry drives the reset pin (if enabled, RSTPE = 1) low for about 34 cycles of t_{cyc} .

⁴ To enter BDM mode following a POR, BKGD/MS should be held low during the power-up and for a hold time of t_{MSH} after V_{DD} rises above V_{LVD} .

⁵ This is the minimum pulse width that is guaranteed to pass through the pin synchronization circuitry. Shorter pulses may or may not be recognized. In stop mode, the synchronizer is bypassed so shorter pulses can be recognized in that case.

⁶ Timing is shown with respect to 20% V_{DD} and 80% V_{DD} levels. Temperature range –40 °C to 125 °C.

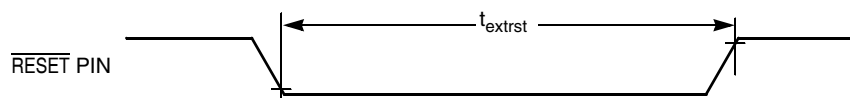

Figure 19. Reset Timing

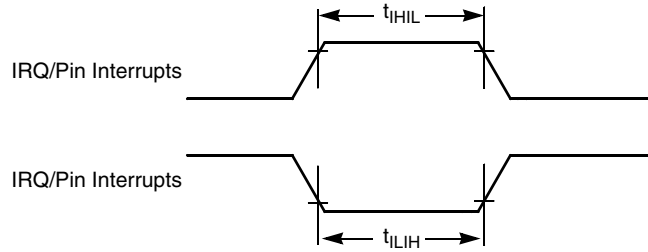

Figure 20. IRQ/Pin Interrupt Timing

3.10.2 TPM/MTIM Module Timing

Synchronizer circuits determine the shortest input pulses that can be recognized or the fastest clock that can be used as the optional external source to the timer counter. These synchronizers operate from the current bus rate clock.

Table 14. TPM Input Timing

Num	C	Rating	Symbol	Min	Max	Unit
1	D	External clock frequency	f_{TPMext}	DC	$f_{Bus}/4$	MHz
2	D	External clock period	t_{TPMext}	4	—	t_{cyc}
3	D	External clock high time	t_{clkh}	1.5	—	t_{cyc}
4	D	External clock low time	t_{clkl}	1.5	—	t_{cyc}
5	D	Input capture pulse width	t_{ICPW}	1.5	—	t_{cyc}

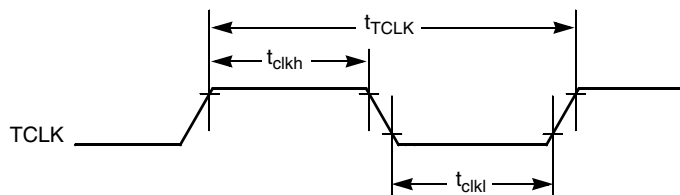

Figure 21. Timer External Clock

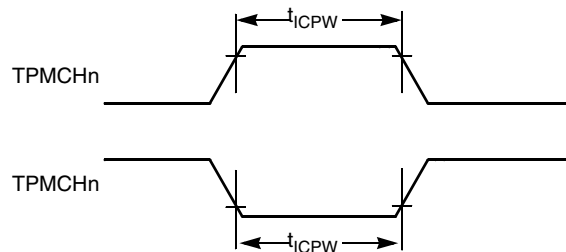

Figure 22. Timer Input Capture Pulse

3.11 Flash Specifications

This section provides details about program/erase times and program-erase endurance for the flash memory.

Program and erase operations do not require any special power sources other than the normal V_{DD} supply. For more detailed information about program/erase operations, see the Memory section in the reference manual.

Table 15. Flash Characteristics

Num	C	Characteristic	Symbol	Min	Typical	Max	Unit
1	D	Supply voltage for program/erase	$V_{\text{prog/erase}}$	2.7	—	5.5	V
2	D	Supply voltage for read operation	V_{Read}	2.7	—	5.5	V
3	D	Internal FCLK frequency ¹	f_{FCLK}	150	—	200	kHz
4	D	Internal FCLK period (1/FCLK)	t_{Fcyc}	5	—	6.67	μs
5	P	Byte program time (random location) ²	t_{prog}	9			t_{Fcyc}
6	P	Byte program time (burst mode) ²	t_{Burst}	4			t_{Fcyc}
7	P	Page erase time ²	t_{Page}	4000			t_{Fcyc}
8	P	Mass erase time ²	t_{Mass}	20,000			t_{Fcyc}
9	C	Program/erase endurance ³ T_L to $T_H = -40\text{ }^\circ\text{C}$ to $125\text{ }^\circ\text{C}$ $T = 25\text{ }^\circ\text{C}$	n_{FLPE}	10,000	— 100,000	—	cycles
10	C	Data retention ⁴	$t_{\text{D_ret}}$	15	100	—	years

¹ The frequency of this clock is controlled by a software setting.

² These values are hardware state machine controlled. User code does not need to count cycles. This information supplied for calculating approximate time to program and erase.

³ **Typical endurance for flash** was evaluated for this product family on the 9S12Dx64. For additional information on how Freescale defines typical endurance, please refer to Engineering Bulletin EB619/D, *Typical Endurance for Nonvolatile Memory*.

⁴ **Typical data retention** values are based on intrinsic capability of the technology measured at high temperature and de-rated to $25\text{ }^\circ\text{C}$ using the Arrhenius equation. For additional information on how Freescale defines typical data retention, please refer to Engineering Bulletin EB618/D, *Typical Data Retention for Nonvolatile Memory*.

4 Ordering Information

This chapter contains ordering information for the device numbering system.

Example of the device numbering system:

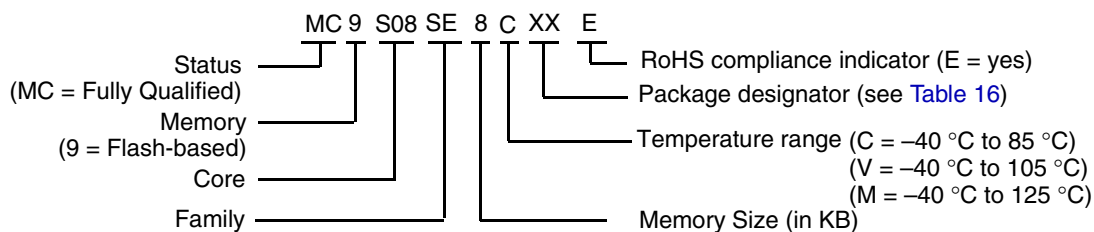

4.1 Package Information

Table 16. Package Descriptions

Pin Count	Package Type	Abbreviation	Designator	Case No.	Document No.
28	Plastic Dual In-line Pin	PDIP	RL	710	98ASB42390B
28	Small Outline Integrated Circuit	SOIC	WL	751F	98ASB42345B
16	Thin Shrink Small Outline Package	TSSOP	TG	948F	98ASH70247A

4.2 Mechanical Drawings

The following pages are mechanical drawings for the packages described in [Table 16](#).

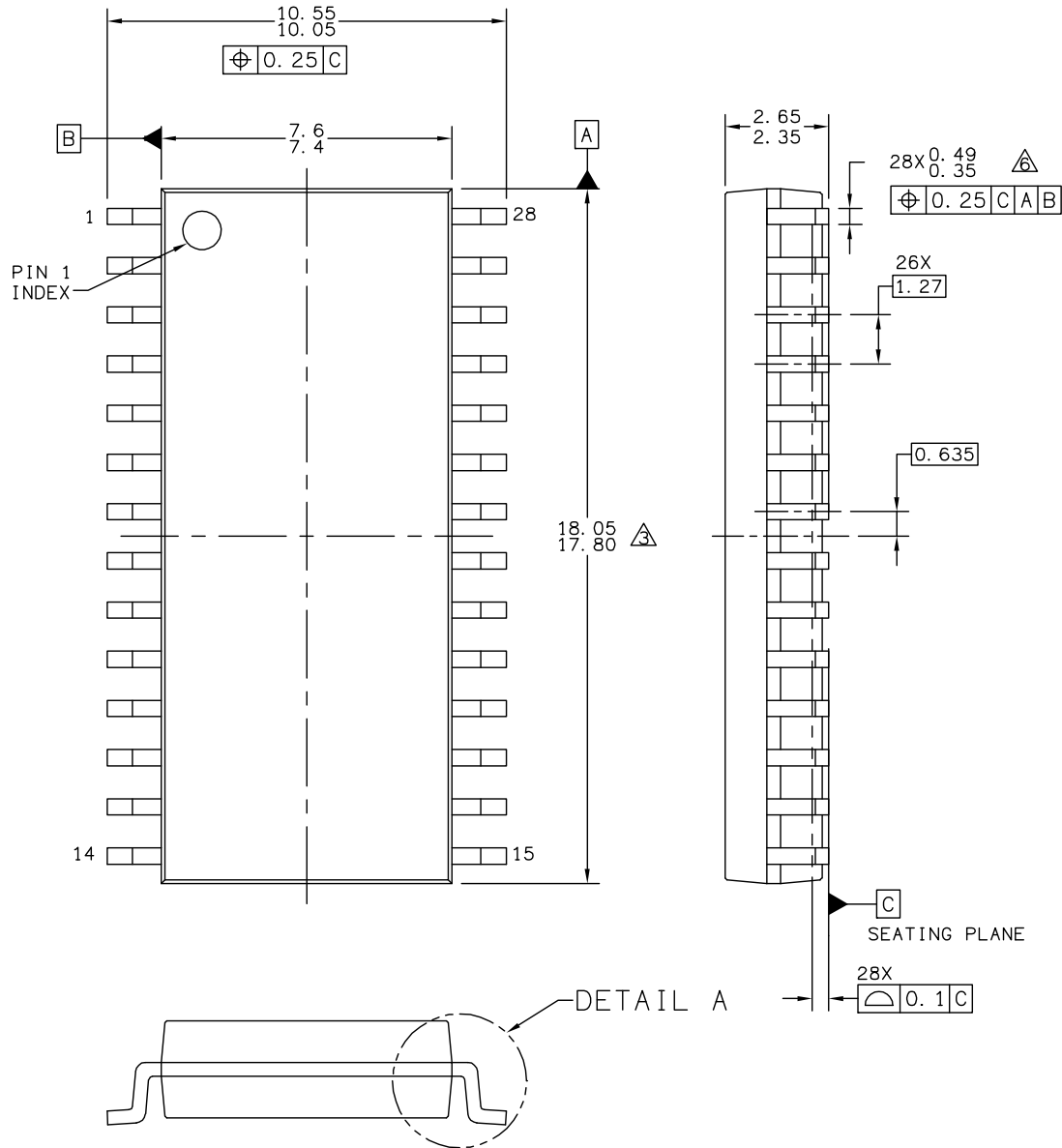

© FREESCALE SEMICONDUCTOR, INC. ALL RIGHTS RESERVED.	MECHANICAL OUTLINE	PRINT VERSION NOT TO SCALE	
TITLE: SOIC, WIDE BODY, 28 LEAD CASEOUTLINE	DOCUMENT NO: 98ASB42345B	REV: G	
	CASE NUMBER: 751F-05	10 MAR 2005	
	STANDARD: MS-013AE		

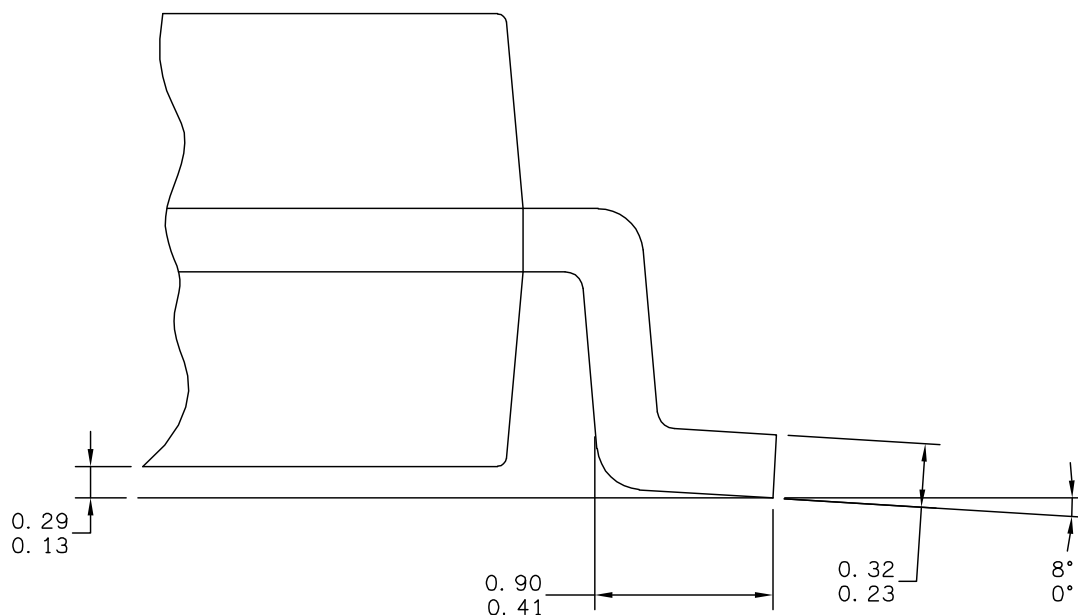

© FREESCALE SEMICONDUCTOR, INC. ALL RIGHTS RESERVED.	MECHANICAL OUTLINE	PRINT VERSION NOT TO SCALE	
TITLE: SOIC, WIDE BODY, 28 LEAD CASEOUTLINE	DOCUMENT NO: 98ASB42345B	REV: G	
	CASE NUMBER: 751F-05	10 MAR 2005	
	STANDARD: MS-013AE		

NOTES:

①. POSITIONAL TOLERANCE OF LEADS, SHALL BE WITHIN 0.25 MM (0.010) AT MAXIMUM MATERIAL CONDITION, IN RELATION TO SEATING PLANE AND EACH OTHER.

②. DIMENSION TO CENTER OF LEADS WHEN FORMED PARALLEL.

③. DIMENSION DOES NOT INCLUDE MOLD FLASH.

4. 710-01 OBSOLETE, NEW STD 710-02.

5. CONTROLLING DIMENSION: INCH

DIM	INCH		MILLIMETER		DIM	INCH		MILLIMETER	
	MIN	MAX	MIN	MAX		MIN	MAX	MIN	MAX
A	1.435	1.465	36.45	37.21					
B	0.540	0.560	13.72	14.22					
C	0.155	0.200	3.94	5.08					
D	0.014	0.022	0.36	0.56					
F	0.040	0.060	1.02	1.52					
G	0.100 BSC		2.54 BSC						
H	0.065	0.085	1.65	2.16					
J	0.008	0.015	0.20	0.38					
K	0.115	0.135	2.92	3.43					
L	0.600 BSC		15.24 BSC						
M	0°	15°	0°	15°					
N	0.020	0.040	0.51	1.02					
© FREESCALE SEMICONDUCTOR, INC. ALL RIGHTS RESERVED.			MECHANICAL OUTLINE		PRINT VERSION NOT TO SCALE				
TITLE: 28 LD PDIP					DOCUMENT NO: 98ASB42390B			REV: D	
					CASE NUMBER: 710-02			24 MAY 2005	
					STANDARD: NON-JEDEC				

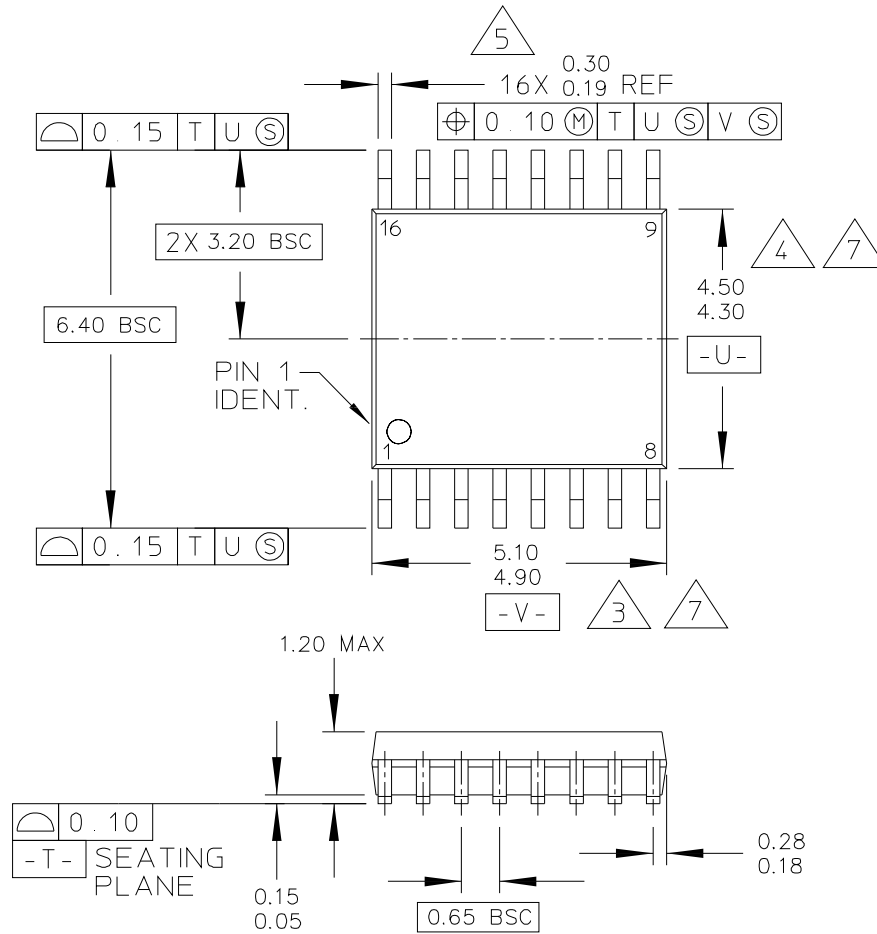

© FREESCALE SEMICONDUCTOR, INC. ALL RIGHTS RESERVED.	MECHANICAL OUTLINE	PRINT VERSION NOT TO SCALE	
TITLE: 16 LD TSSOP, PITCH 0.65MM	DOCUMENT NO: 98ASH70247A	REV: B	
	CASE NUMBER: 948F-01	19 MAY 2005	
	STANDARD: JEDEC		

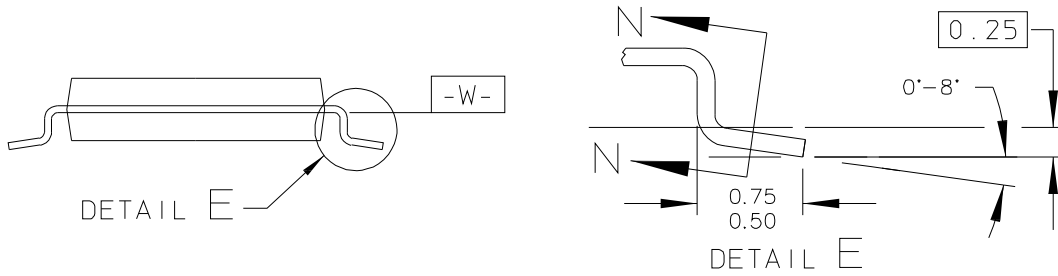
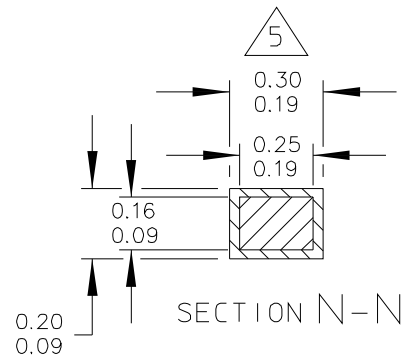

© FREESCALE SEMICONDUCTOR, INC. ALL RIGHTS RESERVED.	MECHANICAL OUTLINE	PRINT VERSION NOT TO SCALE	
TITLE: 16 LD TSSOP, PITCH 0.65MM	DOCUMENT NO: 98ASH70247A	REV: B	
	CASE NUMBER: 948F-01	19 MAY 2005	
	STANDARD: JEDEC		

Ordering Information

NOTES:

1. CONTROLLING DIMENSION: MILLIMETER
2. DIMENSIONS AND TOLERANCES PER ANSI Y14.5M-1982.
3. DIMENSION DOES NOT INCLUDE MOLD FLASH, PROTRUSIONS OR GATE BURRS. MOLD FLASH OR GATE BURRS SHALL NOT EXCEED 0.15 PER SIDE.
4. DIMENSION DOES NOT INCLUDE INTERLEAD FLASH OR PROTRUSION. INTERLEAD FLASH OR PROTRUSION SHALL NOT EXCEED 0.25 PER SIDE.
5. DIMENSION DOES NOT INCLUDE DAMBAR PROTRUSION. ALLOWABLE DAMBAR PROTRUSION SHALL BE 0.08 TOTAL IN EXCESS OF THE DIMENSION AT MAXIMUM MATERIAL CONDITION.
6. TERMINAL NUMBERS ARE SHOWN FOR REFERENCE ONLY.
7. DIMENSIONS ARE TO BE DETERMINED AT DATUM PLANE -W-.

© FREESCALE SEMICONDUCTOR, INC. ALL RIGHTS RESERVED.	MECHANICAL OUTLINE	PRINT VERSION NOT TO SCALE	
TITLE: 16 LD TSSOP, PITCH 0.65MM	DOCUMENT NO: 98ASH70247A	REV: B	
	CASE NUMBER: 948F-01	19 MAY 2005	
	STANDARD: JEDEC		

How to Reach Us:

Home Page:

www.freescale.com

Web Support:

<http://www.freescale.com/support>

USA/Europe or Locations Not Listed:

Freescale Semiconductor, Inc.
Technical Information Center, EL516
2100 East Elliot Road
Tempe, Arizona 85284
1-800-521-6274 or +1-480-768-2130
www.freescale.com/support

Europe, Middle East, and Africa:

Freescale Halbleiter Deutschland GmbH
Technical Information Center
Schatzbogen 7
81829 Muenchen, Germany
+44 1296 380 456 (English)
+46 8 52200080 (English)
+49 89 92103 559 (German)
+33 1 69 35 48 48 (French)
www.freescale.com/support

Japan:

Freescale Semiconductor Japan Ltd.
Headquarters
ARCO Tower 15F
1-8-1, Shimo-Meguro, Meguro-ku,
Tokyo 153-0064
Japan
0120 191014 or +81 3 5437 9125
support.japan@freescale.com

Asia/Pacific:

Freescale Semiconductor China Ltd.
Exchange Building 23F
No. 118 Jianguo Road
Chaoyang District
Beijing 100022
China
+86 10 5879 8000
support.asia@freescale.com

Information in this document is provided solely to enable system and software implementers to use Freescale Semiconductor products. There are no express or implied copyright licenses granted hereunder to design or fabricate any integrated circuits or integrated circuits based on the information in this document.

Freescale Semiconductor reserves the right to make changes without further notice to any products herein. Freescale Semiconductor makes no warranty, representation or guarantee regarding the suitability of its products for any particular purpose, nor does Freescale Semiconductor assume any liability arising out of the application or use of any product or circuit, and specifically disclaims any and all liability, including without limitation consequential or incidental damages. "Typical" parameters that may be provided in Freescale Semiconductor data sheets and/or specifications can and do vary in different applications and actual performance may vary over time. All operating parameters, including "Typicals", must be validated for each customer application by customer's technical experts. Freescale Semiconductor does not convey any license under its patent rights nor the rights of others. Freescale Semiconductor products are not designed, intended, or authorized for use as components in systems intended for surgical implant into the body, or other applications intended to support or sustain life, or for any other application in which the failure of the Freescale Semiconductor product could create a situation where personal injury or death may occur. Should Buyer purchase or use Freescale Semiconductor products for any such unintended or unauthorized application, Buyer shall indemnify and hold Freescale Semiconductor and its officers, employees, subsidiaries, affiliates, and distributors harmless against all claims, costs, damages, and expenses, and reasonable attorney fees arising out of, directly or indirectly, any claim of personal injury or death associated with such unintended or unauthorized use, even if such claim alleges that Freescale Semiconductor was negligent regarding the design or manufacture of the part.

RoHS-compliant and/or Pb-free versions of Freescale products have the functionality and electrical characteristics as their non-RoHS-compliant and/or non-Pb-free counterparts. For further information, see <http://www.freescale.com> or contact your Freescale sales representative.

For information on Freescale's Environmental Products program, go to <http://www.freescale.com/epp>.

Freescale and the Freescale logo are trademarks of Freescale Semiconductor, Inc. All other product or service names are the property of their respective owners.

© Freescale Semiconductor, Inc. 2008-2009, 2015. All rights reserved.

Document Number: MC9S08SE8

Rev. 4

4/2015

Looking for pricing, stock, or lifecycle information?

Click below to explore more details on WIN SOURCE:

 [View MC9S08SE4MTG on WIN SOURCE](#)

 [NXP / Nexperia Information](#)

Optimize Your Supply Chain with WIN SOURCE Solutions

-  Global Sourcing Solution
-  Obsolete Management
-  Cost Control Management
-  Shortage Management
-  Alternative Solution
-  Excess Inventory Management