



THE DATASHEET OF MMBZ5232BW



ZENER DIODE

FEATURES:

- Planar Die Construction
- 200mW Power Dissipation on FR-4 PCB
- General purpose, Medium Current
- Ideally Suited for Automated Assembly
- P/N suffix V means AEC-Q101 qualified, e.g:MMBZ5221BWV
- P/N suffix V means Halogen-free

Marking: see table on page2 The first code

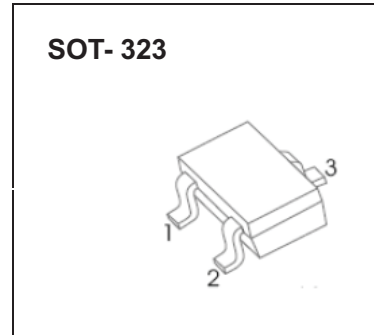
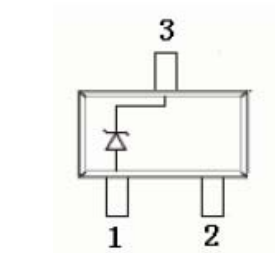

Maximum Ratings(T_a= 25°C unless otherwise specified)

Characteristic	Symbol	Value	Unit
Forward Voltage @ I _F = 10mA	V _F	0.9	V
Power Dissipation	P _D	200	mW
Thermal Resistance, Junction to Ambient Air	R _{θJA}	625	°C/W
Junction Temperature	T _j	-55 ~ +150	°C
Storage Temperature Range	T _{stg}	-55 ~ +150	°C

ELECTRICAL CHARACTERISTICS $T_a=25^\circ\text{C}$ unless otherwise specified

Type Number	Marking Code	Zener Voltage Range (Note 1)			Test Current	Maximum Zener Impedance (Note 2)		Maximum Reverse Leakage Current (Note 1)	
		$V_z @ I_{zT}$			I_{zT}	$Z_{zT} @ I_{zT}$	$Z_{zK} @ I_{zK} = 0.25\text{mA}$	I_R	@ V_R
		Nom (V)	Min (V)	Max (V)	mA	Ω		μA	V
MMBZ5221BW	KC1	2.4	2.28	2.52	20	30	1200	100	1.0
MMBZ5222BW	KC2	2.5	2.38	2.63	20	30	1250	100	1.0
MMBZ5223BW	KC3	2.7	2.57	2.84	20	30	1300	75	1.0
MMBZ5225BW	KC5	3.0	2.85	3.15	20	30	1600	50	1.0
MMBZ5226BW	KG1	3.3	3.14	3.47	20	28	1600	25	1.0
MMBZ5227BW	KG2	3.6	3.42	3.78	20	24	1700	15	1.0
MMBZ5228BW	KG3	3.9	3.71	4.10	20	23	1900	10	1.0
MMBZ5229BW	KG4	4.3	4.09	4.52	20	22	2000	5.0	1.0
MMBZ5230BW	KG5	4.7	4.47	4.94	20	19	1900	5.0	2.0
MMBZ5231BW	KE1	5.1	4.85	5.36	20	17	1600	5.0	2.0
MMBZ5232BW	KE2	5.6	5.32	5.88	20	11	1600	5.0	3.0
MMBZ5233BW	KE3	6.0	5.70	6.30	20	7	1600	5.0	3.5
MMBZ5234BW	KE4	6.2	5.89	6.51	20	7	1000	5.0	4.0
MMBZ5235BW	KE5	6.8	6.46	7.14	20	5	750	3.0	5.0
MMBZ5236BW	KF1	7.5	7.13	7.88	20	6	500	3.0	6.0
MMBZ5237BW	KF2	8.2	7.79	8.61	20	8	500	3.0	6.5
MMBZ5238BW	KF3	8.7	8.27	9.14	20	8	600	3.0	6.5
MMBZ5239BW	KF4	9.1	8.65	9.56	20	10	600	3.0	7.0
MMBZ5240BW	KF5	10	9.50	10.50	20	17	600	3.0	8.0
MMBZ5241BW	KH1	11	10.45	11.55	20	22	600	2.0	8.4
MMBZ5242BW	KH2	12	11.40	12.60	20	30	600	1.0	9.1
MMBZ5243BW	KH3	13	12.35	13.65	9.5	13	600	0.5	9.9
MMBZ5244BW	KH4	14	13.30	14.70	9.0	15	600	0.1	10
MMBZ5245BW	KH5	15	14.25	15.75	8.5	16	600	0.1	11
MMBZ5246BW	KJ1	16	15.20	16.80	7.8	17	600	0.1	12
MMBA5247BW	KJ2	17	16.15	17.85	7.4	19	600	0.1	13
MMBZ5248BW	KJ3	18	17.10	18.90	7.0	21	600	0.1	14
MMBZ5249BW	KJ4	19	18.05	19.95	6.6	23	600	0.1	14
MMBZ5250BW	KJ5	20	19.00	21.00	6.2	25	600	0.1	15
MMBZ5251BW	KK1	22	20.90	23.10	5.6	29	600	0.1	17
MMBZ5252BW	KK2	24	22.80	25.20	5.2	33	600	0.1	18
MMBZ5253BW	KK3	25	23.75	26.25	5.0	35	600	0.1	19
MMBZ5254BW	KK4	27	25.65	28.35	5.0	41	600	0.1	21
MMBZ5255BW	KK5	28	26.60	29.40	4.5	44	600	0.1	21
MMBZ5256BW	KM1	30	28.50	31.50	4.2	49	600	0.1	23
MMBZ5257BW	KM2	33	31.35	34.65	3.8	58	700	0.1	25
MMBZ5258BW	KM3	36	34.20	37.80	3.4	70	700	0.1	27
MMBZ5259BW	KM4	39	37.05	40.95	3.2	80	800	0.1	30

Notes: 1. Short duration test pulse used to minimize self-heating effect.
2. $f = 1\text{KHz}$.

RATING AND CHARACTERISTICS CURVES (MMBZ5221BW THRU MMBZ5259BW)

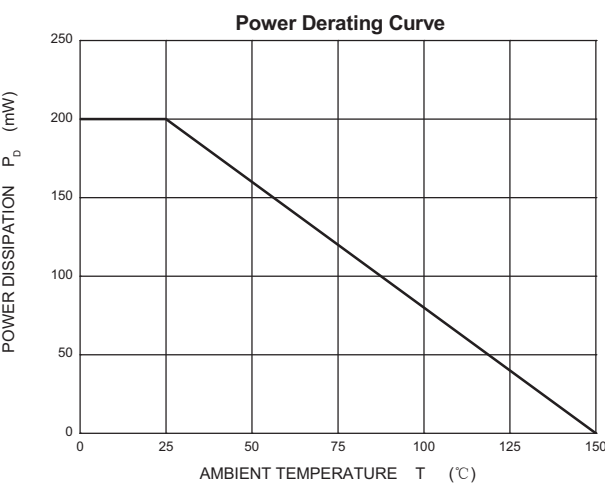
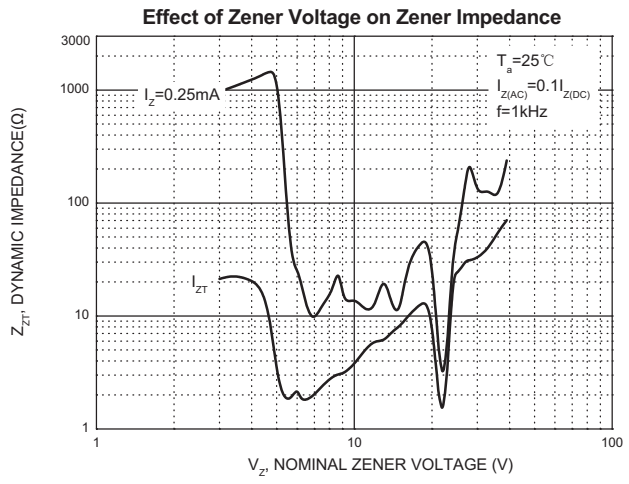
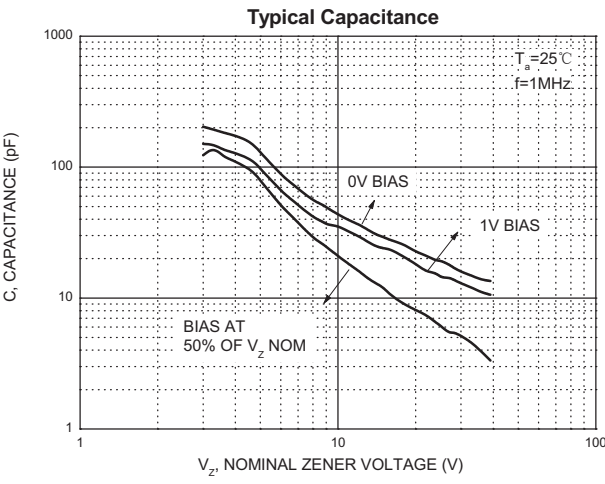
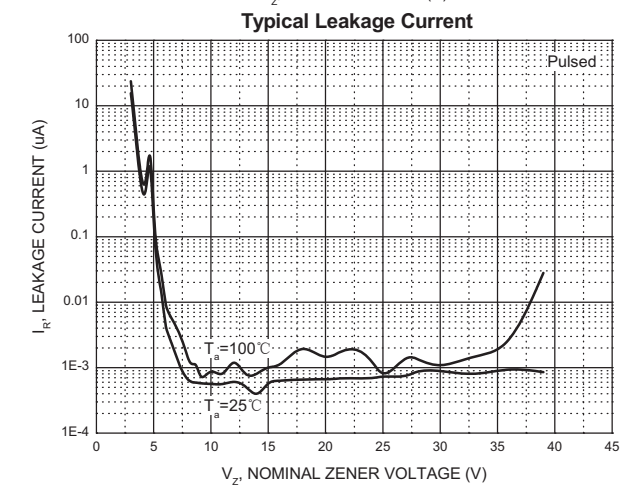
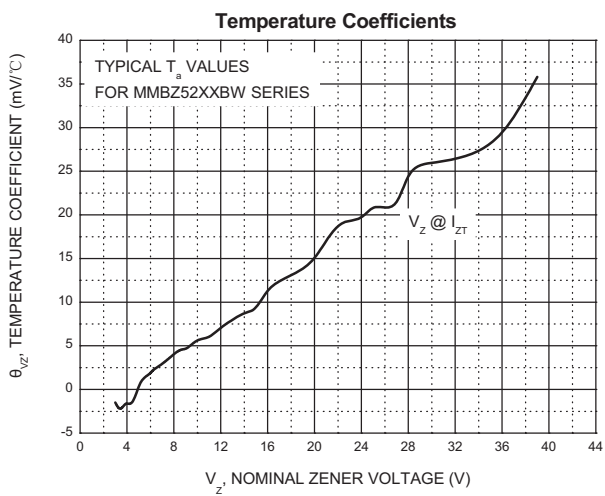
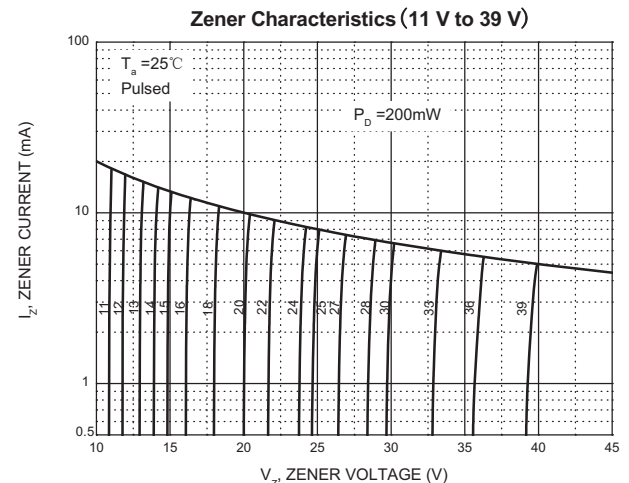
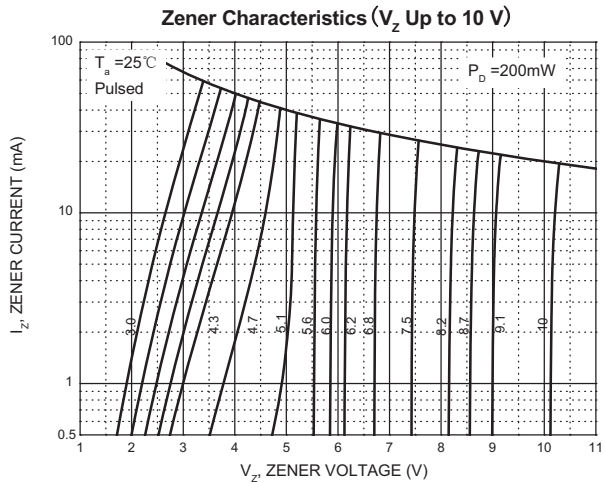

SOT-323 Package Outline Dimensions

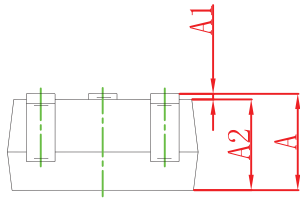
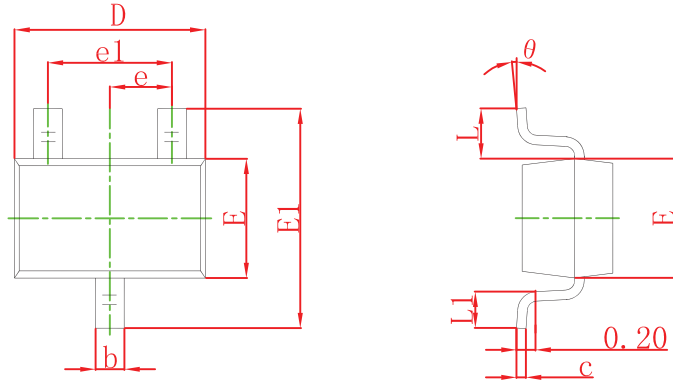

Symbol	Dimensions In Millimeters		Dimensions In Inches	
	Min	Max	Min	Max
A	0.900	1.100	0.035	0.043
A1	0.000	0.100	0.000	0.004
A2	0.900	1.000	0.035	0.039
b	0.200	0.400	0.008	0.016
c	0.080	0.150	0.003	0.006
D	2.000	2.200	0.079	0.087
E	1.150	1.350	0.045	0.053
E1	2.150	2.450	0.085	0.096
e	0.650 TYP		0.026 TYP	
e1	1.200	1.400	0.047	0.055
L	0.525 REF		0.021 REF	
L1	0.260	0.460	0.010	0.018
θ	0°	8°	0°	8°

SOT-323 Suggested Pad Layout

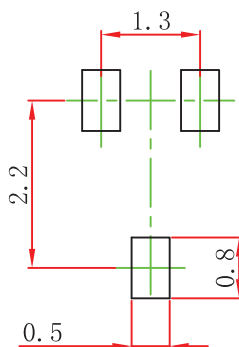

- Note:
1. Controlling dimension: in millimeters.
 2. General tolerance: ± 0.05 mm.
 3. The pad layout is for reference purposes only.

SOT-323 Tape and Reel

SOT-323 Embossed Carrier Tape

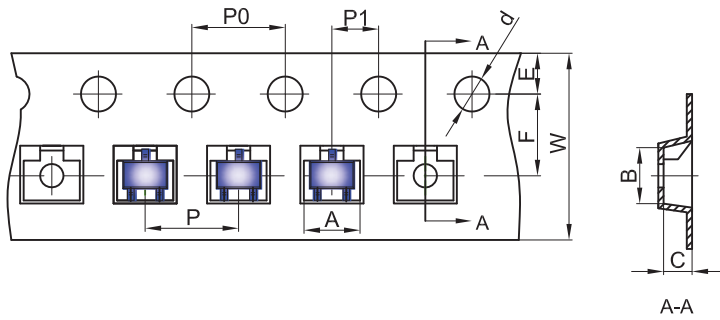

Packaging Description:
 SOT-323 parts are shipped in tape. The carrier tape is made from a dissipative (carbon filled) polycarbonate resin. The cover tape is a multilayer film (Heat Activated Adhesive in nature) primarily composed of polyester film, adhesive layer, sealant, and anti-static sprayed agent. These reeled parts in standard option are shipped with 3,000 units per 7" or 17.8cm diameter reel. The reels are clear in color and is made of polystyrene plastic (anti-static coated).

Dimensions are in millimeter										
Pkg type	A	B	C	d	E	F	P0	P	P1	W
SOT-323	2.25	2.55	1.19	Ø1.55	1.75	3.50	4.00	4.00	2.00	8.00

SOT-323 Tape Leader and Trailer

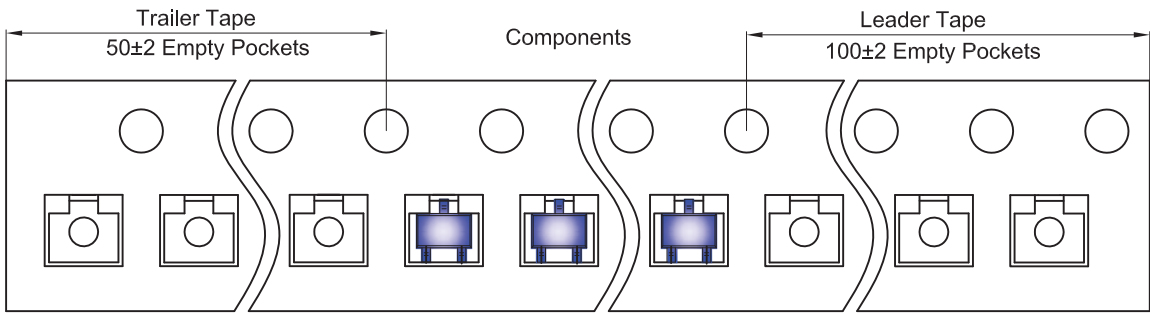

SOT-323 Reel

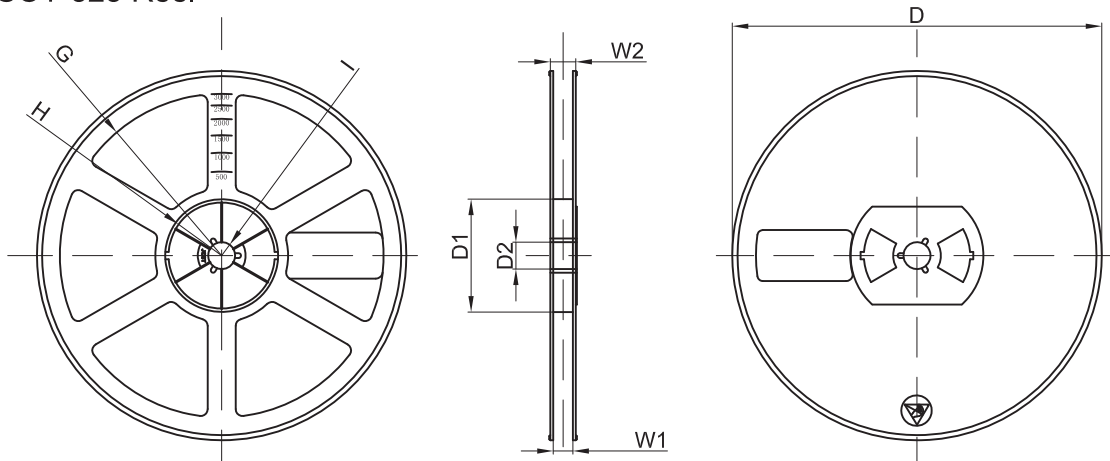

Dimensions are in millimeter								
Reel Option	D	D1	D2	G	H	I	W1	W2
7" Dia	Ø178.00	54.40	13.00	R78.00	R25.60	R6.50	9.50	12.30

REEL	Reel Size	Box	Box Size(mm)	Carton	Carton Size(mm)	G.W.(kg)
3000 pcs	7 inch	45,000 pcs	203×203×195	180,000 pcs	438×438×220	



DISCLAIMER NOTICE

Rectron Inc reserves the right to make changes without notice to any product specification herein, to make corrections, modifications, enhancements or other changes. Rectron Inc or anyone on its behalf assumes no responsibility or liability for any errors or inaccuracies. Data sheet specifications and its information contained are intended to provide a product description only. "Typical" parameters which may be included on RECTRON data sheets and/ or specifications can and do vary in different applications and actual performance may vary over time. Rectron Inc does not assume any liability arising out of the application or use of any product or circuit.

Rectron products are not designed, intended or authorized for use in medical, life-saving implant or other applications intended for life-sustaining or other related applications where a failure or malfunction of component or circuitry may directly or indirectly cause injury or threaten a life without expressed written approval of Rectron Inc. Customers using or selling Rectron components for use in such applications do so at their own risk and shall agree to fully indemnify Rectron Inc and its subsidiaries harmless against all claims, damages and expenditures.

Looking for pricing, stock, or lifecycle information?

Click below to explore more details on WIN SOURCE:

-  [View MMBZ5232BW on WIN SOURCE](#)
-  [Rectron USA Information](#)

Optimize Your Supply Chain with WIN SOURCE Solutions

-  Global Sourcing Solution
-  Obsolete Management
-  Cost Control Management
-  Shortage Management
-  Alternative Solution
-  Excess Inventory Management