



**THE DATASHEET OF  
NCP130AMX120TCG**



# 300 mA, Very Low Dropout Bias Rail CMOS Voltage Regulator

## NCP130

The NCP130 is a 300 mA VLDO equipped with NMOS pass transistor and a separate bias supply voltage ( $V_{BIAS}$ ). The device provides very stable, accurate output voltage with low noise suitable for space constrained, noise sensitive applications. In order to optimize performance for battery operated portable applications, the NCP130 features low  $I_Q$  consumption. The XDFN6 1.2 mm x 1.2 mm package is optimized for use in space constrained applications.

### Features

- Input Voltage Range: 0.8 V to 5.5 V
- Bias Voltage Range: 2.4 V to 5.5 V
- Fixed Output Voltage Device
- Output Voltage Range: 0.8 V to 2.1 V
- $\pm 1.5\%$  Accuracy over Temperature,  $0.5\% V_{OUT}$  @  $25^\circ\text{C}$
- Ultra-Low Dropout: 150 mV Maximum at 300 mA
- Very Low Bias Input Current of Typ.  $80 \mu\text{A}$
- Very Low Bias Input Current in Disable Mode: Typ.  $0.5 \mu\text{A}$
- Logic Level Enable Input for ON/OFF Control
- Output Active Discharge Option Available
- Stable with a  $1 \mu\text{F}$  Ceramic Capacitor
- Available in XDFN6 – 1.2 mm x 1.2 mm x 0.37 mm Package
- These Devices are Pb-Free, Halogen Free/BFR Free and are RoHS Compliant

### Typical Applications

- Battery-powered Equipment
- Smartphones, Tablets
- Cameras, DVRs, STB and Camcorders

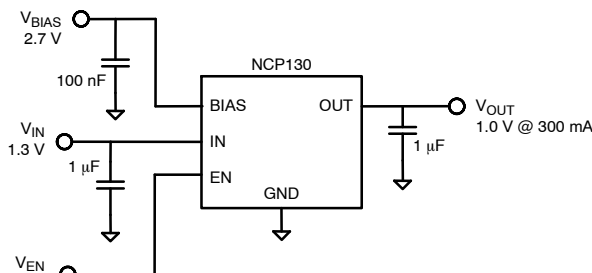

Figure 1. Typical Application Schematics

### MARKING DIAGRAM



XDFN6  
 CASE 711AT



XX = Specific Device Code  
 M = Date Code

### PIN CONNECTIONS

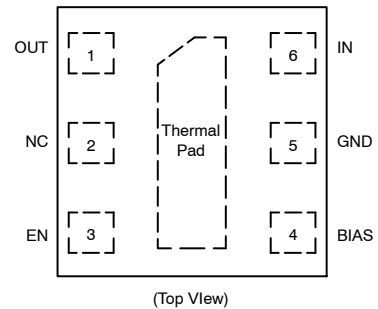

### ORDERING INFORMATION

See detailed ordering, marking and shipping information on page 8 of this data sheet.

# NCP130

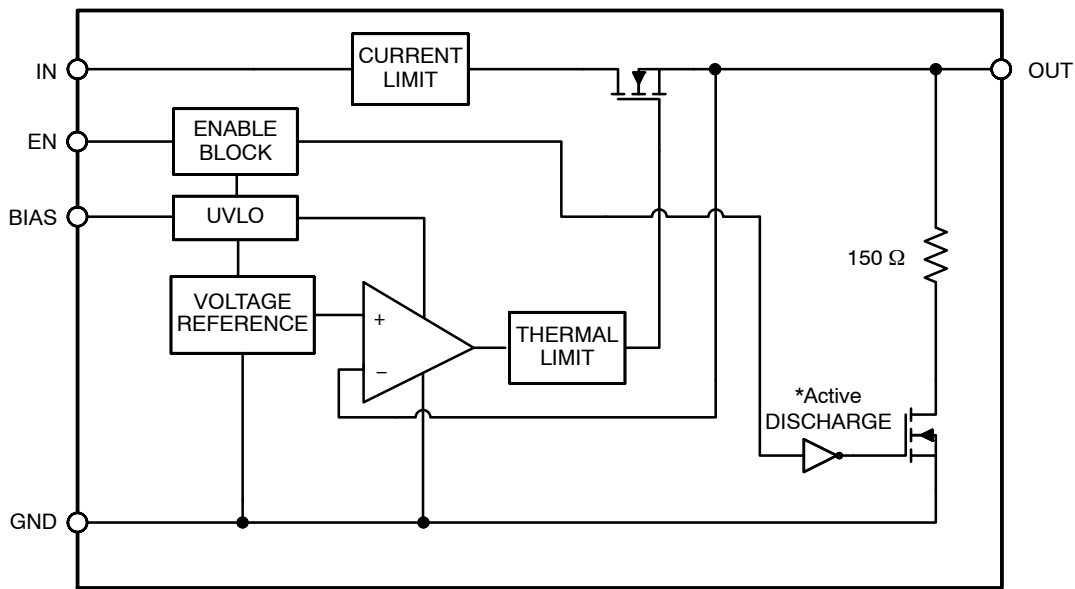

\*Active output discharge function is present only in NCP130AMXyyyTCG devices.  
yyy denotes the particular output voltage option.

**Figure 2. Simplified Schematic Block Diagram**

## PIN FUNCTION DESCRIPTION

Pin No.	Pin Name	Description
1	OUT	Regulated Output Voltage pin
2	N/C	Not internally connected
3	EN	Enable pin. Driving this pin high enables the regulator. Driving this pin low puts the regulator into shutdown mode.
4	BIAS	Bias voltage supply for internal control circuits. This pin is monitored by internal Under-Voltage Lockout Circuit.
5	GND	Ground pin
6	IN	Input Voltage Supply pin
Pad		Should be soldered to the ground plane for increased thermal performance.

## ABSOLUTE MAXIMUM RATINGS

Rating	Symbol	Value	Unit
Input Voltage (Note 1)	$V_{IN}$	-0.3 to 6	V
Output Voltage	$V_{OUT}$	-0.3 to $(V_{IN}+0.3) \leq 6$	V
Chip Enable and Bias Input	$V_{EN}, V_{BIAS}$	-0.3 to 6	V
Output Short Circuit Duration	$t_{SC}$	unlimited	s
Maximum Junction Temperature	$T_J$	150	°C
Storage Temperature	$T_{STG}$	-55 to 150	°C
ESD Capability, Human Body Model (Note 2)	$ESD_{HBM}$	2000	V
ESD Capability, Machine Model (Note 2)	$ESD_{MM}$	200	V

Stresses exceeding those listed in the Maximum Ratings table may damage the device. If any of these limits are exceeded, device functionality should not be assumed, damage may occur and reliability may be affected.

1. Refer to ELECTRICAL CHARACTERISTICS and APPLICATION INFORMATION for Safe Operating Area.
2. This device series incorporates ESD protection (except OUT pin) and is tested by the following methods:  
ESD Human Body Model tested per EIA/JESD22-A114  
ESD Machine Model tested per EIA/JESD22-A115  
Latchup Current Maximum Rating tested per JEDEC standard: JESD78.

## THERMAL CHARACTERISTICS

Rating	Symbol	Value	Unit
Thermal Characteristics, XDFN6 1.2 mm x 1.2 mm Thermal Resistance, Junction-to-Air	$R_{\theta JA}$	170	°C/W

# NCP130

## ELECTRICAL CHARACTERISTICS

$-40^{\circ}\text{C} \leq T_J \leq 85^{\circ}\text{C}$ ;  $V_{\text{BIAS}} = 2.7\text{ V}$  or  $(V_{\text{OUT}} + 1.6\text{ V})$ , whichever is greater,  $V_{\text{IN}} = V_{\text{OUT(NOM)}} + 0.3\text{ V}$ ,  $I_{\text{OUT}} = 1\text{ mA}$ ,  $V_{\text{EN}} = 1\text{ V}$ , unless otherwise noted.  $C_{\text{IN}} = 1\text{ }\mu\text{F}$ ,  $C_{\text{BIAS}} = 0.1\text{ }\mu\text{F}$ ,  $C_{\text{OUT}} = 1\text{ }\mu\text{F}$  (effective capacitance) (Note 3). Typical values are at  $T_J = +25^{\circ}\text{C}$ . Min/Max values are for  $-40^{\circ}\text{C} \leq T_J \leq 85^{\circ}\text{C}$  unless otherwise noted. (Note 4)

Parameter	Test Conditions	Symbol	Min	Typ	Max	Unit
Operating Input Voltage Range		$V_{\text{IN}}$	$V_{\text{OUT}}+V_{\text{DO}}$		5.5	V
Operating Bias Voltage Range		$V_{\text{BIAS}}$	$(V_{\text{OUT}}+1.35) \geq 2.4$		5.5	V
Undervoltage Lock-out	$V_{\text{BIAS}}$ Rising Hysteresis	UVLO		1.6 0.2		V
Output Voltage Accuracy	$-40^{\circ}\text{C} \leq T_J \leq 85^{\circ}\text{C}$ , $V_{\text{OUT(NOM)}} + 0.3\text{ V} \leq V_{\text{IN}} \leq 5.0\text{ V}$ , $2.7\text{ V}$ or $(V_{\text{OUT(NOM)}} + 1.6\text{ V})$ , whichever is greater < $V_{\text{BIAS}} < 5.5\text{ V}$ , $1\text{ mA} < I_{\text{OUT}} < 300\text{ mA}$	$V_{\text{OUT}}$	-1.5		+1.5	%
Output Voltage Accuracy		$V_{\text{OUT}}$		$\pm 0.5$		%
$V_{\text{IN}}$ Line Regulation	$V_{\text{OUT(NOM)}} + 0.3\text{ V} \leq V_{\text{IN}} \leq 5.0\text{ V}$	LineReg		0.01		%/V
$V_{\text{BIAS}}$ Line Regulation	$2.7\text{ V}$ or $(V_{\text{OUT(NOM)}} + 1.6\text{ V})$ , whichever is greater < $V_{\text{BIAS}} < 5.5\text{ V}$	LineReg		0.01		%/V
Load Regulation	$I_{\text{OUT}} = 1\text{ mA}$ to $300\text{ mA}$	LoadReg		1.5		mV
$V_{\text{IN}}$ Dropout Voltage	$I_{\text{OUT}} = 300\text{ mA}$ (Note 5)	$V_{\text{DO}}$		75	150	mV
$V_{\text{BIAS}}$ Dropout Voltage	$I_{\text{OUT}} = 300\text{ mA}$ , $V_{\text{IN}} = V_{\text{BIAS}}$ (Note 5)	$V_{\text{DO}}$		1.1	1.4	V
Output Current Limit	$V_{\text{OUT}} = 90\% V_{\text{OUT(NOM)}}$	$I_{\text{CL}}$	400	550	850	mA
Bias Pin Operating Current	$V_{\text{BIAS}} = 2.7\text{ V}$	$I_{\text{BIAS}}$		80	110	$\mu\text{A}$
Bias Pin Disable Current	$V_{\text{EN}} \leq 0.4\text{ V}$	$I_{\text{BIAS(DIS)}}$		0.5	1	$\mu\text{A}$
Vinput Pin Disable Current	$V_{\text{EN}} \leq 0.4\text{ V}$	$I_{\text{VIN(DIS)}}$		0.5	1	$\mu\text{A}$
EN Pin Threshold Voltage	EN Input Voltage "H"	$V_{\text{EN(H)}}$	0.9			V
	EN Input Voltage "L"	$V_{\text{EN(L)}}$			0.4	
EN Pull Down Current	$V_{\text{EN}} = 5.5\text{ V}$	$I_{\text{EN}}$		0.3	1.0	$\mu\text{A}$
Turn-On Time	$C_{\text{OUT}} = 1\text{ }\mu\text{F}$ , From assertion of $V_{\text{EN}}$ to $V_{\text{OUT}} = 98\% V_{\text{OUT(NOM)}}$ , $V_{\text{OUT(NOM)}} = 1.05\text{ V}$	$t_{\text{ON}}$		150		$\mu\text{s}$
Power Supply Rejection Ratio	$V_{\text{IN}}$ to $V_{\text{OUT}}$ , $f = 1\text{ kHz}$ , $I_{\text{OUT}} = 300\text{ mA}$ , $V_{\text{IN}} \geq V_{\text{OUT}} + 0.5\text{ V}$	PSRR( $V_{\text{IN}}$ )		65		dB
	$V_{\text{BIAS}}$ to $V_{\text{OUT}}$ , $f = 1\text{ kHz}$ , $I_{\text{OUT}} = 300\text{ mA}$ , $V_{\text{IN}} \geq V_{\text{OUT}} + 0.5\text{ V}$	PSRR( $V_{\text{BIAS}}$ )		80		
Output Noise Voltage	$V_{\text{IN}} = V_{\text{OUT}} + 0.5\text{ V}$ , $V_{\text{OUT(NOM)}} = 1.05\text{ V}$ , $f = 10\text{ Hz}$ to $100\text{ kHz}$	$V_{\text{N}}$		40		$\mu\text{V}_{\text{RMS}}$
Thermal Shutdown Threshold	Temperature increasing			160		$^{\circ}\text{C}$
	Temperature decreasing			140		
Output Discharge Pull-Down	$V_{\text{EN}} \leq 0.4\text{ V}$ , $V_{\text{OUT}} = 0.5\text{ V}$ , NCP130A options only	$R_{\text{DISCH}}$		150		$\Omega$

Product parametric performance is indicated in the Electrical Characteristics for the listed test conditions, unless otherwise noted. Product performance may not be indicated by the Electrical Characteristics if operated under different conditions.

- Effective capacitance, including the effect of DC bias, tolerance and temperature. See the Application Information section for more information.
- Performance guaranteed over the indicated operating temperature range by design and/or characterization. Production tested at  $T_A = 25^{\circ}\text{C}$ . Low duty cycle pulse techniques are used during the testing to maintain the junction temperature as close to ambient as possible.
- Dropout voltage is characterized when  $V_{\text{OUT}}$  falls 3% below  $V_{\text{OUT(NOM)}}$ .

# NCP130

## APPLICATIONS INFORMATION

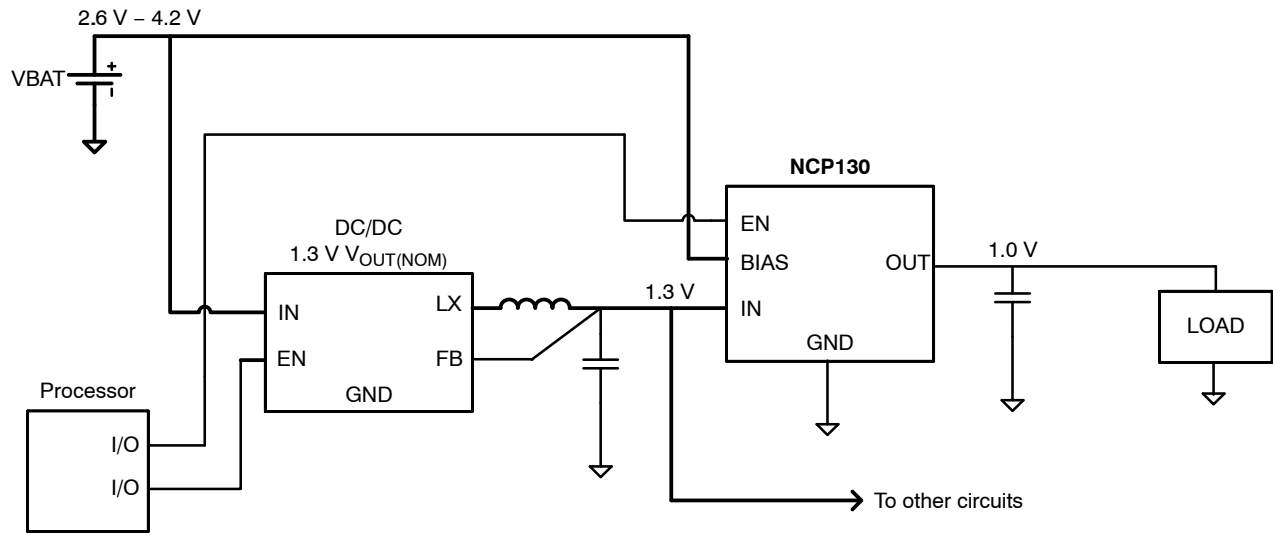

Figure 3. Typical Application: Low-Voltage Post-Regulator with ON/OFF functionality

# NCP130

## TYPICAL CHARACTERISTICS

AT  $T_J = +25^\circ\text{C}$ ,  $V_{IN} = V_{OUT(TYP)} + 0.3\text{ V}$ ,  $V_{BIAS} = 2.7\text{ V}$ ,  $V_{EN} = V_{BIAS}$ ,  $V_{OUT(NOM)} = 1.05\text{ V}$ ,  $I_{OUT} = 300\text{ mA}$ ,  $C_{IN} = 1\text{ MF}$ ,  $C_{BIAS} = 0.1\text{ MF}$ , AND  $C_{OUT} = 1\text{ MF}$  (EFFECTIVE CAPACITANCE), UNLESS OTHERWISE NOTED.

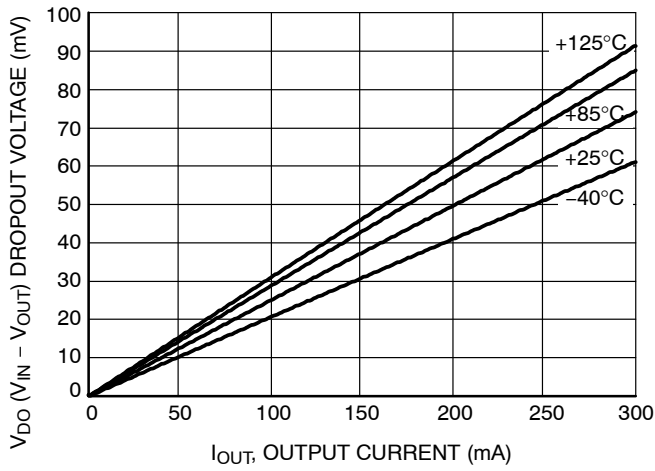

Figure 4.  $V_{IN}$  Dropout Voltage vs.  $I_{OUT}$  and Temperature  $T_J$

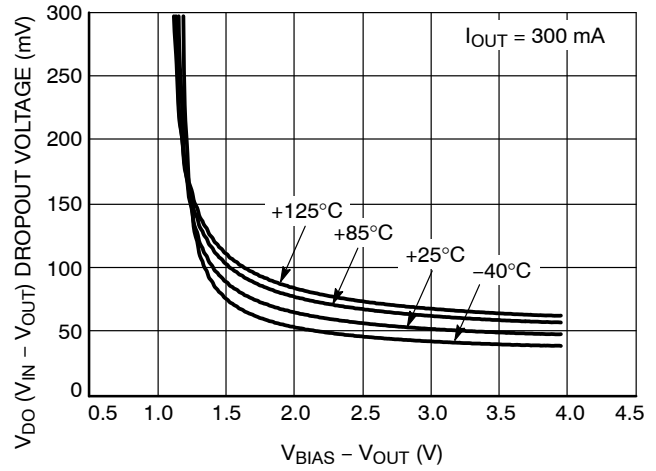

Figure 5.  $V_{IN}$  Dropout Voltage vs.  $(V_{BIAS} - V_{OUT})$  and Temperature  $T_J$

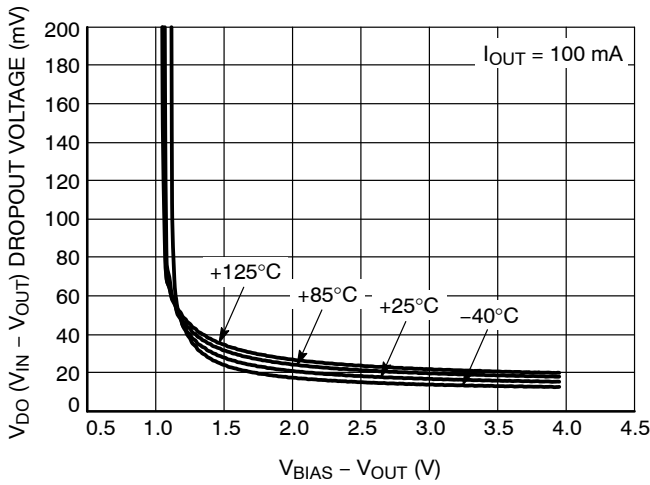

Figure 6.  $V_{IN}$  Dropout Voltage vs.  $(V_{BIAS} - V_{OUT})$  and Temperature  $T_J$

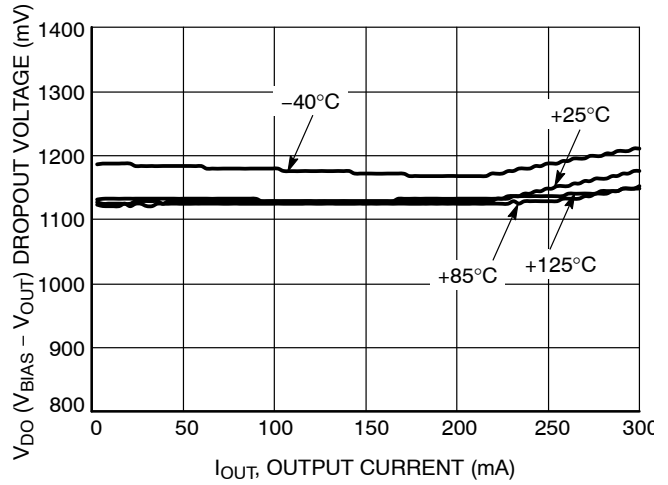

Figure 7.  $V_{BIAS}$  Dropout Voltage vs.  $I_{OUT}$  and Temperature  $T_J$

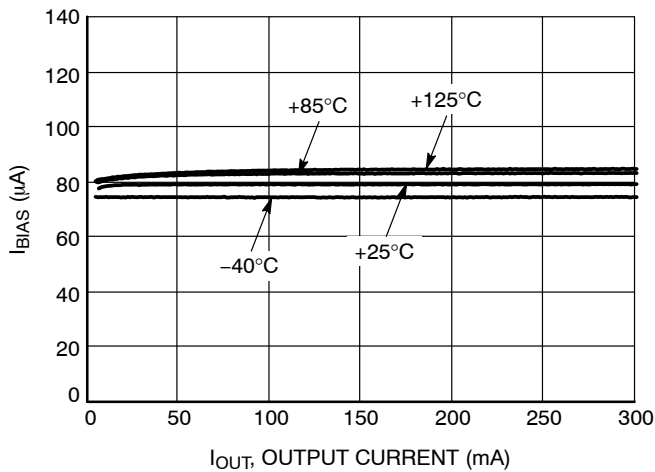

Figure 8. BIAS Pin Current vs.  $I_{OUT}$  and Temperature  $T_J$

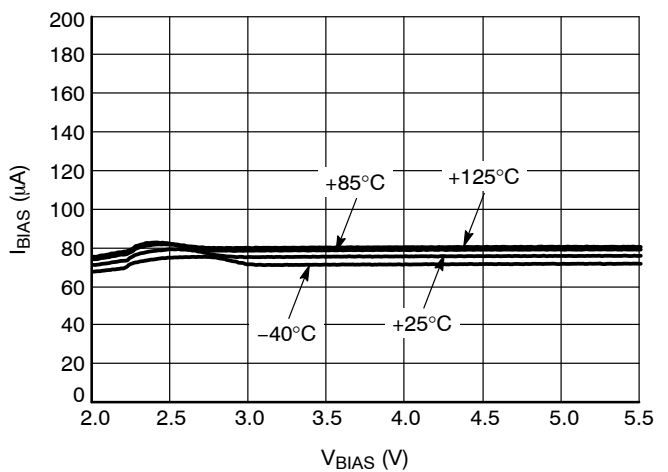

Figure 9. BIAS Pin Current vs.  $V_{BIAS}$  and Temperature  $T_J$

# NCP130

## TYPICAL CHARACTERISTICS

AT  $T_J = +25^\circ\text{C}$ ,  $V_{IN} = V_{OUT(TYP)} + 0.3\text{ V}$ ,  $V_{BIAS} = 2.7\text{ V}$ ,  $V_{EN} = V_{BIAS}$ ,  $V_{OUT(NOM)} = 1.05\text{ V}$ ,  $I_{OUT} = 300\text{ mA}$ ,  $C_{IN} = 1\text{ MF}$ ,  $C_{BIAS} = 0.1\text{ MF}$ , AND  $C_{OUT} = 1\text{ MF}$  (EFFECTIVE CAPACITANCE), UNLESS OTHERWISE NOTED.

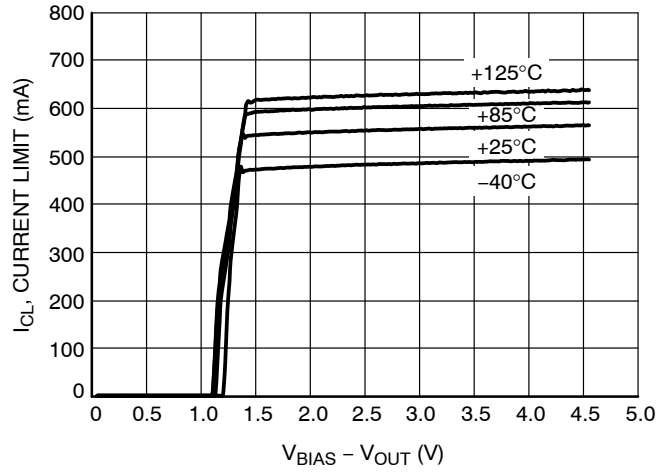

Figure 10. Current Limit vs.  $(V_{BIAS} - V_{OUT})$

## APPLICATIONS INFORMATION

The NCP130 dual-rail very low dropout voltage regulator is using NMOS pass transistor for output voltage regulation from  $V_{IN}$  voltage. All the low current internal control circuitry is powered from the  $V_{BIAS}$  voltage.

The use of an NMOS pass transistor offers several advantages in applications. Unlike a PMOS topology devices, the output capacitor has reduced impact on loop stability.  $V_{IN}$  to  $V_{OUT}$  operating voltage difference can be very low compared with standard PMOS regulators in very low  $V_{IN}$  applications.

The NCP130 offers smooth monotonic start-up. The controlled voltage rising limits the inrush current.

The Enable (EN) input is equipped with internal hysteresis.

NCP130 is a Fixed Voltage linear regulator.

### Dropout Voltage

Because of two power supply inputs  $V_{IN}$  and  $V_{BIAS}$  and one  $V_{OUT}$  regulator output, there are two Dropout voltages specified.

The first, the  $V_{IN}$  Dropout voltage is the voltage difference ( $V_{IN} - V_{OUT}$ ) when  $V_{OUT}$  starts to decrease by percents specified in the Electrical Characteristics table.  $V_{BIAS}$  is high enough, specific value is published in the Electrical Characteristics table.

The second,  $V_{BIAS}$  dropout voltage is the voltage difference ( $V_{BIAS} - V_{OUT}$ ) when  $V_{IN}$  and  $V_{BIAS}$  pins are joined together and  $V_{OUT}$  starts to decrease.

### Input and Output Capacitors

The device is designed to be stable for ceramic output capacitors with Effective capacitance in the range from 1  $\mu\text{F}$  to 10  $\mu\text{F}$ . The device is also stable with multiple capacitors in parallel, having the total effective capacitance in the specified range.

In applications where no low input supplies impedance available (PCB inductance in  $V_{IN}$  and/or  $V_{BIAS}$  inputs as example), the recommended  $C_{IN} = 1 \mu\text{F}$  and  $C_{BIAS} = 0.1 \mu\text{F}$  or greater. Ceramic capacitors are recommended. For the best performance all the capacitors should be connected to the NCP130 respective pins directly in the device PCB copper layer, not through vias having not negligible impedance.

When using small ceramic capacitor, their capacitance is not constant but varies with applied DC biasing voltage, temperature and tolerance. The effective capacitance can be much lower than their nominal capacitance value, most importantly in negative temperatures and higher LDO output voltages. That is why the recommended Output capacitor capacitance value is specified as Effective value in the specific application conditions.

### Enable Operation

The enable pin will turn the regulator on or off. The threshold limits are covered in the electrical characteristics table in this data sheet. If the enable function is not to be used then the pin should be connected to  $V_{IN}$  or  $V_{BIAS}$ .

### Current Limitation

The internal Current Limitation circuitry allows the device to supply the full nominal current and surges but protects the device against Current Overload or Short.

### Thermal Protection

Internal thermal shutdown (TSD) circuitry is provided to protect the integrated circuit in the event that the maximum junction temperature is exceeded. When TSD activated, the regulator output turns off. When cooling down under the low temperature threshold, device output is activated again. This TSD feature is provided to prevent failures from accidental overheating.

# NCP130

## ORDERING INFORMATION

Device	Nominal Output Voltage	Marking	Marking Rotation	Option	Package	Shipping <sup>†</sup>		
NCP130AMX080TCG (Note 6)	0.80 V	Q	180°	Output Active Discharge	XDFN6 (Pb-Free)	3000 or 5000 / Tape & Reel (Note 6)		
NCP130AMX090TCG (Note 6)	0.90 V	EA	No rotation					
NCP130AMX100TCG (Note 6)	1.00 V	EC	No rotation					
NCP130AMX105TCG (Note 6)	1.05 V	R	180°					
NCP130AMX110TCG (Note 6)	1.10 V	T	180°					
NCP130AMX115TCG (Note 6)	1.15 V	V	180°					
NCP130AMX120TCG (Note 6)	1.20 V	Y	180°					
NCP130AMX150TCG (Note 6)	1.50 V	2	180°					
NCP130AMX180TCG (Note 6)	1.80 V	3	180°					
NCP130AMX210TCG (Note 6)	2.10 V	4	180°					
NCP130BMX080TCG (Note 6)	0.80 V	Q	270°	Non-Active Discharge			XDFN6 (Pb-Free)	3000 or 5000 / Tape & Reel (Note 6)
NCP130BMX090TCG (Note 6)	0.90 V	HA	No rotation					
NCP130BMX100TCG	1.00 V	HC	No rotation					
NCP130BMX105TCG (Note 6)	1.05 V	R	270°					
NCP130BMX110TCG (Note 6)	1.10 V	T	270°					
NCP130BMX115TCG (Note 6)	1.15 V	V	270°					
NCP130BMX120TCG (Note 6)	1.20 V	Y	270°					
NCP130BMX150TCG (Note 6)	1.50 V	2	270°					
NCP130BMX180TCG (Note 6)	1.80 V	3	270°					
NCP130BMX210TCG (Note 6)	2.10 V	4	270°					

†For information on tape and reel specifications, including part orientation and tape sizes, please refer to our Tape and Reel Packaging Specifications Brochure, [BRD8011/D](#).

To order other package and voltage variants, please contact your **onsemi** sales representative  
 6. Product processed after October 1, 2022 are shipped with quantity 5000 units / tape & reel.

# MECHANICAL CASE OUTLINE

## PACKAGE DIMENSIONS

ON Semiconductor®



SCALE 4:1

XDFN6 1.20x1.20, 0.40P  
CASE 711AT  
ISSUE C

DATE 04 DEC 2015

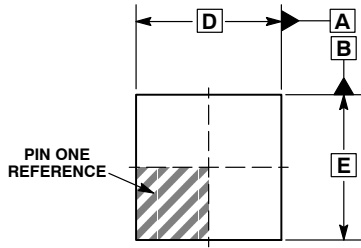

TOP VIEW

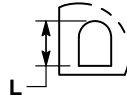

DETAIL A  
OPTIONAL  
CONSTRUCTION

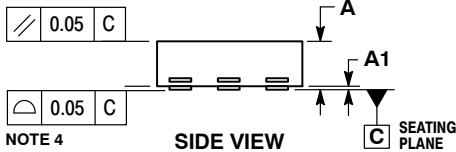

SIDE VIEW

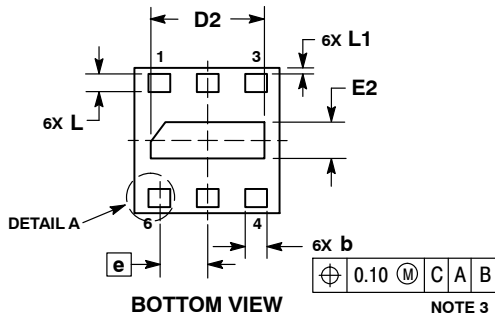

BOTTOM VIEW

NOTES:

1. DIMENSIONING AND TOLERANCING PER ASME Y14.5M, 1994.
2. CONTROLLING DIMENSION: MILLIMETERS.
3. DIMENSION b APPLIES TO THE PLATED TERMINALS.
4. COPLANARITY APPLIES TO THE PAD AS WELL AS THE TERMINALS.

DIM	MILLIMETERS		
	MIN	TYP	MAX
A	0.30	0.37	0.45
A1	0.00	0.03	0.05
b	0.13	0.18	0.23
D	1.15	1.20	1.25
D2	0.84	0.94	1.04
E	1.15	1.20	1.25
E2	0.20	0.30	0.40
e	0.40 BSC		
L	0.15	0.20	0.25
L1	0.00	0.05	0.10

GENERIC MARKING DIAGRAM\*



XX = Specific Device Code  
M = Date Code

\*This information is generic. Please refer to device data sheet for actual part marking. Pb-Free indicator, "G" or microdot "▪", may or may not be present.

RECOMMENDED MOUNTING FOOTPRINT\*

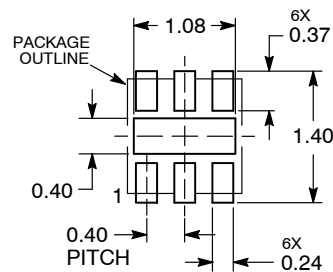

DIMENSIONS: MILLIMETERS

\*For additional information on our Pb-Free strategy and soldering details, please download the ON Semiconductor Soldering and Mounting Techniques Reference Manual, SOLDERRM/D.

DOCUMENT NUMBER:	98AON76141F	Electronic versions are uncontrolled except when accessed directly from the Document Repository. Printed versions are uncontrolled except when stamped "CONTROLLED COPY" in red.
DESCRIPTION:	XDFN6, 1.20 X 1.20, 0.40P	PAGE 1 OF 1

ON Semiconductor and are trademarks of Semiconductor Components Industries, LLC dba ON Semiconductor or its subsidiaries in the United States and/or other countries. ON Semiconductor reserves the right to make changes without further notice to any products herein. ON Semiconductor makes no warranty, representation or guarantee regarding the suitability of its products for any particular purpose, nor does ON Semiconductor assume any liability arising out of the application or use of any product or circuit, and specifically disclaims any and all liability, including without limitation special, consequential or incidental damages. ON Semiconductor does not convey any license under its patent rights nor the rights of others.

**onsemi**, **Onsemi**, and other names, marks, and brands are registered and/or common law trademarks of Semiconductor Components Industries, LLC dba "**onsemi**" or its affiliates and/or subsidiaries in the United States and/or other countries. **onsemi** owns the rights to a number of patents, trademarks, copyrights, trade secrets, and other intellectual property. A listing of **onsemi**'s product/patent coverage may be accessed at [www.onsemi.com/site/pdf/Patent-Marking.pdf](http://www.onsemi.com/site/pdf/Patent-Marking.pdf). **onsemi** reserves the right to make changes at any time to any products or information herein, without notice. The information herein is provided "as-is" and **onsemi** makes no warranty, representation or guarantee regarding the accuracy of the information, product features, availability, functionality, or suitability of its products for any particular purpose, nor does **onsemi** assume any liability arising out of the application or use of any product or circuit, and specifically disclaims any and all liability, including without limitation special, consequential or incidental damages. Buyer is responsible for its products and applications using **onsemi** products, including compliance with all laws, regulations and safety requirements or standards, regardless of any support or applications information provided by **onsemi**. "Typical" parameters which may be provided in **onsemi** data sheets and/or specifications can and do vary in different applications and actual performance may vary over time. All operating parameters, including "Typicals" must be validated for each customer application by customer's technical experts. **onsemi** does not convey any license under any of its intellectual property rights nor the rights of others. **onsemi** products are not designed, intended, or authorized for use as a critical component in life support systems or any FDA Class 3 medical devices or medical devices with a same or similar classification in a foreign jurisdiction or any devices intended for implantation in the human body. Should Buyer purchase or use **onsemi** products for any such unintended or unauthorized application, Buyer shall indemnify and hold **onsemi** and its officers, employees, subsidiaries, affiliates, and distributors harmless against all claims, costs, damages, and expenses, and reasonable attorney fees arising out of, directly or indirectly, any claim of personal injury or death associated with such unintended or unauthorized use, even if such claim alleges that **onsemi** was negligent regarding the design or manufacture of the part. **onsemi** is an Equal Opportunity/Affirmative Action Employer. This literature is subject to all applicable copyright laws and is not for resale in any manner.

## ADDITIONAL INFORMATION

### TECHNICAL PUBLICATIONS:

Technical Library: [www.onsemi.com/design/resources/technical-documentation](http://www.onsemi.com/design/resources/technical-documentation)  
onsemi Website: [www.onsemi.com](http://www.onsemi.com)

### ONLINE SUPPORT: [www.onsemi.com/support](http://www.onsemi.com/support)

For additional information, please contact your local Sales Representative at [www.onsemi.com/support/sales](http://www.onsemi.com/support/sales)

## Looking for pricing, stock, or lifecycle information?

Click below to explore more details on WIN SOURCE:

- ⊖ [View NCP130AMX120TCG on WIN SOURCE](#)
- ⊖ [ON Semiconductor Information](#)

## Optimize Your Supply Chain with WIN SOURCE Solutions

- ✓ Global Sourcing Solution
- ✓ Obsolete Management
- ✓ Cost Control Management
- ✓ Shortage Management
- ✓ Alternative Solution
- ✓ Excess Inventory Management