



**THE DATASHEET OF
NCP161AFCS330T2G**



LDO Regulator for RF and Analog Circuits - Ultra-Low Noise and High PSRR

450 mA

NCP161

The NCP161 is a linear regulator capable of supplying 450 mA output current. Designed to meet the requirements of RF and analog circuits, the NCP161 device provides low noise, high PSRR, low quiescent current, and very good load/line transients. The device is designed to work with a 1 μ F input and a 1 μ F output ceramic capacitor. It is available in two thickness ultra-small 0.35P, 0.64 mm x 0.64 mm Chip Scale Package (CSP) and XDFN4 0.65P, 1 mm x 1 mm.

Features

- Operating Input Voltage Range: 1.9 V to 5.5 V
- Available in Fixed Voltage Option: 1.8 V to 5.14 V
- $\pm 2\%$ Accuracy Over Load/Temperature
- Ultra Low Quiescent Current Typ. 18 μ A
- Standby Current: Typ. 0.1 μ A
- Very Low Dropout: 150 mV at 450 mA
- Ultra High PSRR: Typ. 98 dB at 20 mA, f = 1 kHz
- Ultra Low Noise: 10 μ V_{RMS}
- Stable with a 1 μ F Small Case Size Ceramic Capacitors
- Available in
 - WLCSP4 0.64 mm x 0.64 mm x 0.4 mm
 - WLCSP4 0.64 mm x 0.64 mm x 0.33 mm
 - XDFN4 1 mm x 1 mm x 0.4 mm
 - SOT23-5 2.9 mm x 2.8 mm x 1.2 mm
- These Devices are Pb-Free and are RoHS Compliant

Typical Applications

- Battery-powered Equipment
- Wireless LAN Devices
- Smartphones, Tablets
- Cameras, DVRs, STB and Camcorders

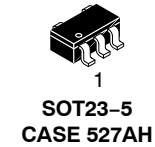

MARKING DIAGRAMS

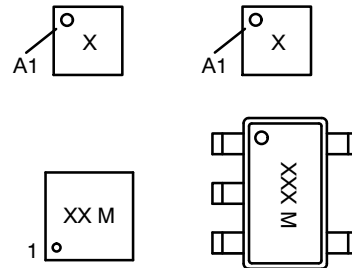

X, XX, XXX = Specific Device Code
M = Date Code

PIN CONNECTIONS (Top Views)

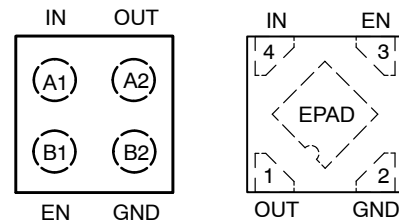
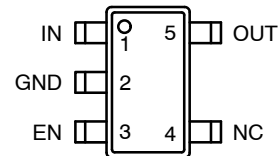

ORDERING INFORMATION

See detailed ordering and shipping information on page 17 of this data sheet.

NCP161

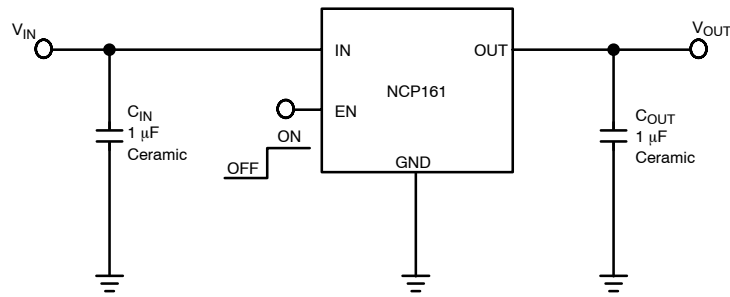

Figure 1. Typical Application Schematics

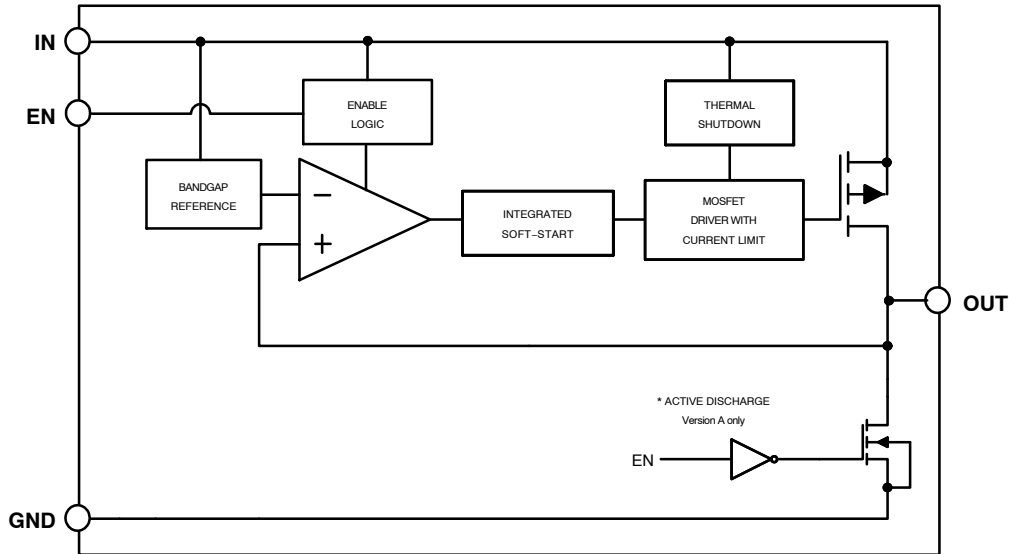

Figure 2. Simplified Schematic Block Diagram

PIN FUNCTION DESCRIPTION

Pin No. CSP4	Pin No. SOT23-5	Pin No. XDFN4	Pin Name	Description
A1	1	4	IN	Input voltage supply pin
A2	5	1	OUT	Regulated output voltage. The output should be bypassed with small 1 μF ceramic capacitor.
B1	3	3	EN	Chip enable: Applying $V_{EN} < 0.4 \text{ V}$ disables the regulator, Pulling $V_{EN} > 1.2 \text{ V}$ enables the LDO.
B2	2	2	GND	Common ground connection
-	-	EPAD	EPAD	Expose pad should be tied to ground plane for better power dissipation

NCP161

ABSOLUTE MAXIMUM RATINGS

Rating	Symbol	Value	Unit
Input Voltage (Note 1)	V_{IN}	-0.3 V to 6	V
Output Voltage	V_{OUT}	-0.3 to $V_{IN} + 0.3$, max. 6	V
Chip Enable Input	V_{CE}	-0.3 to 6	V
Output Short Circuit Duration	t_{SC}	unlimited	s
Maximum Junction Temperature	T_J	150	°C
Storage Temperature	T_{STG}	-55 to 150	°C
ESD Capability, Human Body Model (Note 2)	ESD_{HBM}	2000	V
ESD Capability, Machine Model (Note 2)	ESD_{MM}	200	V

Stresses exceeding those listed in the Maximum Ratings table may damage the device. If any of these limits are exceeded, device functionality should not be assumed, damage may occur and reliability may be affected.

1. Refer to ELECTRICAL CHARACTERISTICS and APPLICATION INFORMATION for Safe Operating Area.
2. This device series incorporates ESD protection and is tested by the following methods:
 - ESD Human Body Model tested per EIA/JESD22-A114
 - ESD Machine Model tested per EIA/JESD22-A115
 - Latchup Current Maximum Rating tested per JEDEC standard: JESD78.

THERMAL CHARACTERISTICS

Rating	Symbol	Value	Unit
Thermal Characteristics, CSP4 (Note 3)	$R_{\theta JA}$	108	°C/W
Thermal Characteristics, XDFN4 (Note 3)		198.1	
Thermal Characteristics, SOT23-5 (Note 3)		218	

3. Measured according to JEDEC board specification. Detailed description of the board can be found in JESD51-7

NCP161

ELECTRICAL CHARACTERISTICS $-40^{\circ}\text{C} \leq T_J \leq 125^{\circ}\text{C}$; $V_{IN} = V_{OUT(NOM)} + 1\text{ V}$; $I_{OUT} = 1\text{ mA}$, $C_{IN} = C_{OUT} = 1\text{ }\mu\text{F}$, unless otherwise noted. $V_{EN} = 1.2\text{ V}$. Typical values are at $T_J = +25^{\circ}\text{C}$ (Note 4).

Parameter	Test Conditions		Symbol	Min	Typ	Max	Unit
Operating Input Voltage			V_{IN}	1.9		5.5	V
Output Voltage Accuracy	$V_{IN} = V_{OUT(NOM)} + 1\text{ V}$ $0\text{ mA} \leq I_{OUT} \leq 450\text{ mA}$	WLCSP4, XDFN4	V_{OUT}	-2		+2	%
	$V_{IN} = V_{OUT(NOM)} + 1\text{ V}$	SOT23-5		-2		+2	
Line Regulation	$V_{OUT(NOM)} + 1\text{ V} \leq V_{IN} \leq 5.5\text{ V}$		LineReg		0.02		%/V
Load Regulation	$I_{OUT} = 1\text{ mA to }450\text{ mA}$ WLCSP4, XDFN4	WLCSP4, XDFN4	LoadReg		0.001		%/mA
		SOT23-5			0.005	0.008	
Dropout Voltage (Note 5)	$I_{OUT} = 450\text{ mA}$ WLCSP4, XDFN4	$V_{OUT(NOM)} = 1.8\text{ V}$	V_{DO}		300	450	mV
		$V_{OUT(NOM)} = 1.85\text{ V}$			290	393	
		$V_{OUT(NOM)} = 2.5\text{ V}$			190	315	
		$V_{OUT(NOM)} = 2.8\text{ V}$			175	290	
		$V_{OUT(NOM)} = 2.85\text{ V}$			170	290	
		$V_{OUT(NOM)} = 3.0\text{ V}$			165	275	
		$V_{OUT(NOM)} = 3.3\text{ V}$			160	260	
		$V_{OUT(NOM)} = 3.5\text{ V}$			150	255	
		$V_{OUT(NOM)} = 4.5\text{ V}$			120	210	
		$V_{OUT(NOM)} = 5.0\text{ V}$			105	190	
Dropout Voltage (Note 5)	$I_{OUT} = 450\text{ mA}$ SOT23-5	$V_{OUT(NOM)} = 1.8\text{ V}$	V_{DO}		365	480	mV
		$V_{OUT(NOM)} = 2.8\text{ V}$			260	345	
		$V_{OUT(NOM)} = 3.0\text{ V}$			240	330	
		$V_{OUT(NOM)} = 3.3\text{ V}$			225	305	
Output Current Limit	$V_{OUT} = 90\% V_{OUT(NOM)}$		I_{CL}	450	700		mA
Short Circuit Current	$V_{OUT} = 0\text{ V}$		I_{SC}		690		
Quiescent Current	$I_{OUT} = 0\text{ mA}$		I_Q		18	23	μA
Shutdown Current	$V_{EN} \leq 0.4\text{ V}$, $V_{IN} = 4.8\text{ V}$		I_{DIS}		0.01	1	μA
EN Pin Threshold Voltage	EN Input Voltage "H"		V_{ENH}	1.2			V
	EN Input Voltage "L"		V_{ENL}			0.4	
EN Pull Down Current	$V_{EN} = 4.8\text{ V}$		I_{EN}		0.2	0.5	μA
Turn-On Time	$C_{OUT} = 1\text{ }\mu\text{F}$, From assertion of V_{EN} to $V_{OUT} = 95\% V_{OUT(NOM)}$				120		μs
Power Supply Rejection Ratio	$I_{OUT} = 20\text{ mA}$	$f = 100\text{ Hz}$	PSRR		91		dB
		$f = 1\text{ kHz}$			98		
		$f = 10\text{ kHz}$			82		
		$f = 100\text{ kHz}$			48		
Output Voltage Noise	$f = 10\text{ Hz to }100\text{ kHz}$	$I_{OUT} = 1\text{ mA}$ $I_{OUT} = 250\text{ mA}$	V_N		14 10		μV_{RMS}
Thermal Shutdown Threshold	Temperature rising		T_{SDH}		160		$^{\circ}\text{C}$
	Temperature falling		T_{SDL}		140		$^{\circ}\text{C}$
Active output discharge resistance	$V_{EN} < 0.4\text{ V}$, Version A only		R_{DIS}		280		Ω
Line transient (Note 6)	$V_{IN} = (V_{OUT(NOM)} + 1\text{ V})$ to $(V_{OUT(NOM)} + 1.6\text{ V})$ in $30\text{ }\mu\text{s}$, $I_{OUT} = 1\text{ mA}$		Tran _{LINE}	-1			mV
	$V_{IN} = (V_{OUT(NOM)} + 1.6\text{ V})$ to $(V_{OUT(NOM)} + 1\text{ V})$ in $30\text{ }\mu\text{s}$, $I_{OUT} = 1\text{ mA}$					+1	
Load transient (Note 6)	$I_{OUT} = 1\text{ mA to }450\text{ mA}$ in $10\text{ }\mu\text{s}$		Tran _{LOAD}	-40			mV
	$I_{OUT} = 450\text{ mA to }1\text{ mA}$ in $10\text{ }\mu\text{s}$					+40	

Product parametric performance is indicated in the Electrical Characteristics for the listed test conditions, unless otherwise noted. Product performance may not be indicated by the Electrical Characteristics if operated under different conditions.

4. Performance guaranteed over the indicated operating temperature range by design and/or characterization. Production tested at $T_A = 25^{\circ}\text{C}$.

Low duty cycle pulse techniques are used during the testing to maintain the junction temperature as close to ambient as possible.

5. Dropout voltage is characterized when V_{OUT} falls 100 mV below $V_{OUT(NOM)}$.

6. Guaranteed by design.

TYPICAL CHARACTERISTICS

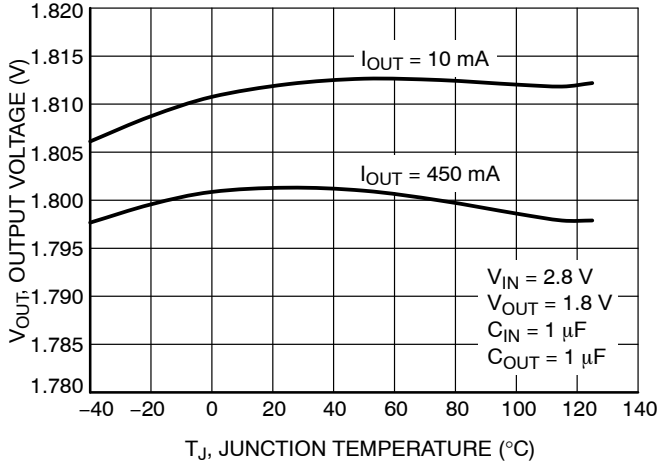

Figure 3. Output Voltage vs. Temperature – $V_{OUT} = 1.8\text{ V}$ – XDFN Package



Figure 4. Output Voltage vs. Temperature – $V_{OUT} = 2.5\text{ V}$ – XDFN Package



Figure 5. Output Voltage vs. Temperature – $V_{OUT} = 3.3\text{ V}$ – XDFN Package

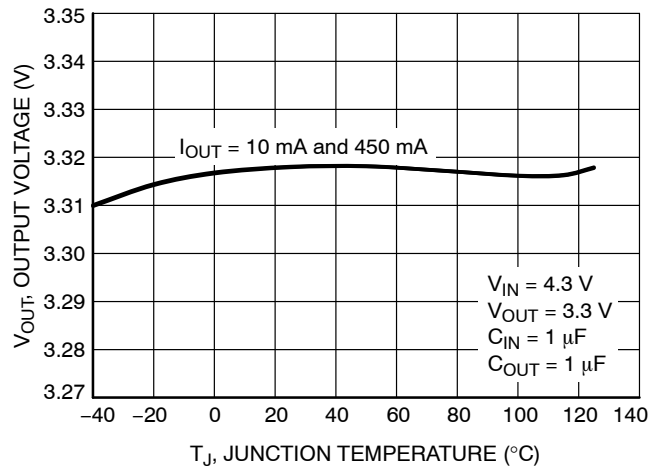

Figure 6. Output Voltage vs. Temperature – $V_{OUT} = 3.3\text{ V}$ – CSP Package



Figure 7. Output Voltage vs. Temperature – $V_{OUT} = 5.14\text{ V}$ – XDFN Package

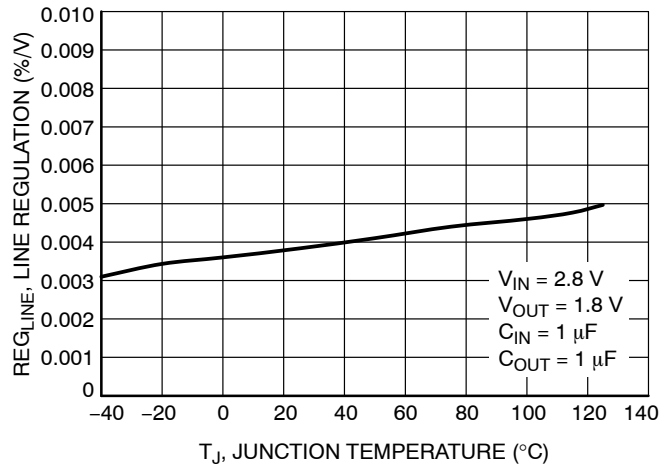

Figure 8. Line Regulation vs. Temperature – $V_{OUT} = 1.8\text{ V}$

NCP161

TYPICAL CHARACTERISTICS



Figure 9. Line Regulation vs. Temperature – $V_{OUT} = 3.3\text{ V}$

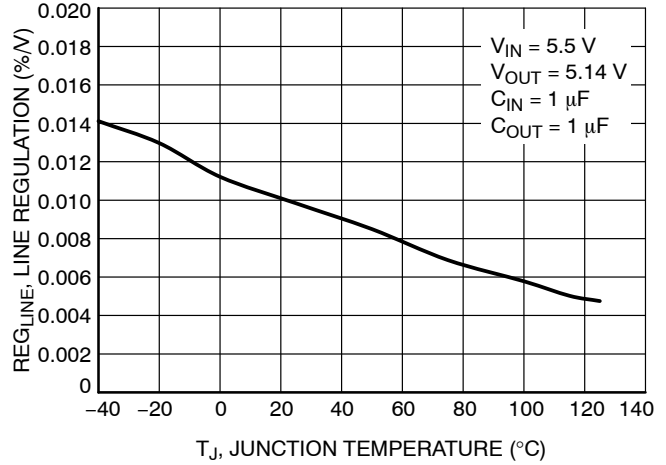

Figure 10. Line Regulation vs. Temperature – $V_{OUT} = 5.14\text{ V}$



Figure 11. Load Regulation vs. Temperature – $V_{OUT} = 1.8\text{ V}$ (WLCSP4)

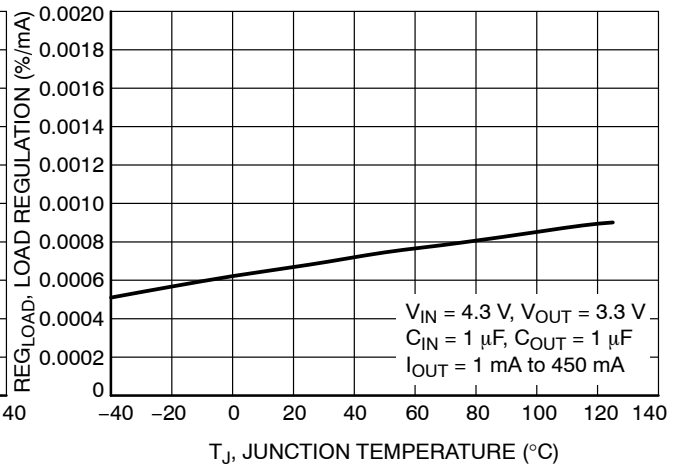

Figure 12. Load Regulation vs. Temperature – $V_{OUT} = 3.3\text{ V}$ (WLCSP4)



Figure 13. Load Regulation vs. Temperature – $V_{OUT} = 5.14\text{ V}$ (WLCSP4)

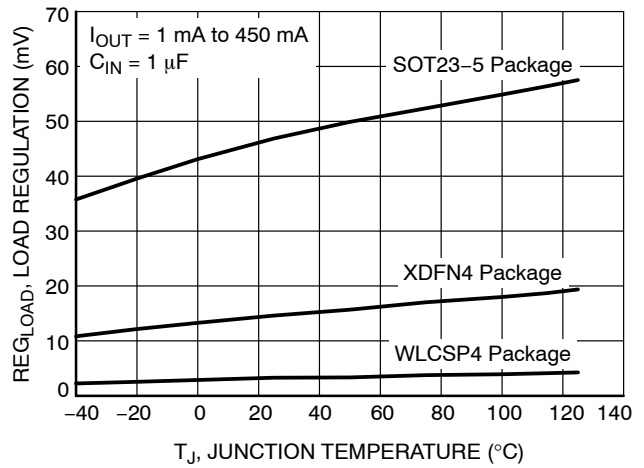

Figure 14. Load Regulation vs. Temperature

NCP161

TYPICAL CHARACTERISTICS



**Figure 15. Ground Current vs. Load Current –
V_{OUT} = 1.8 V**

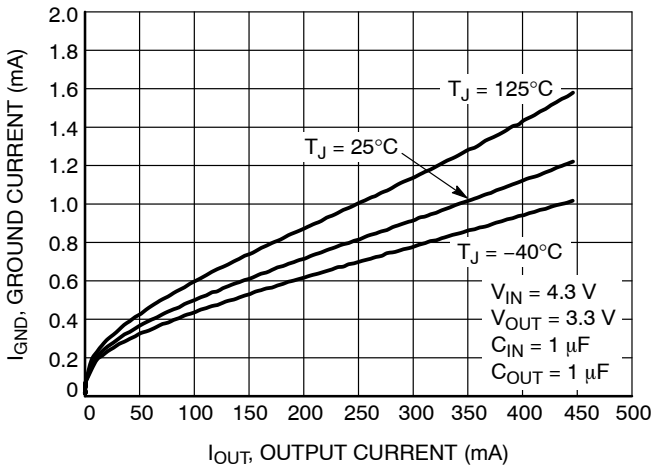

**Figure 16. Ground Current vs. Load Current –
V_{OUT} = 3.3 V**

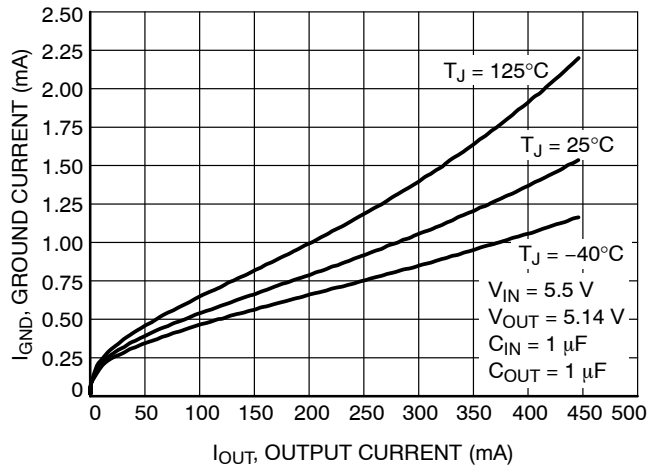

**Figure 17. Ground Current vs. Load Current –
V_{OUT} = 5.14 V**



**Figure 18. Dropout Voltage vs. Load Current –
V_{OUT} = 1.8 V**

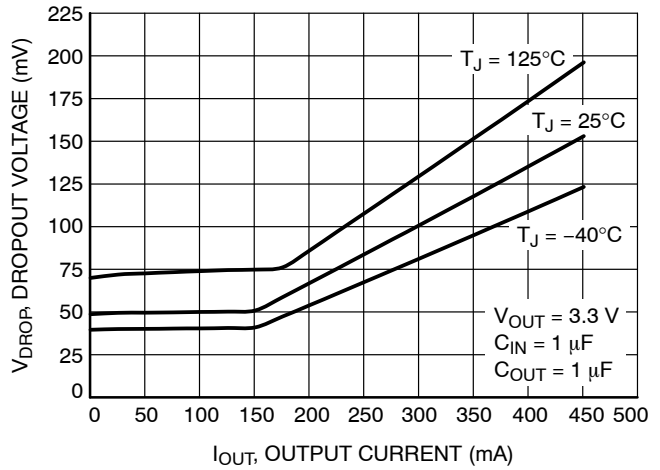

**Figure 19. Dropout Voltage vs. Load Current –
V_{OUT} = 3.3 V**

NCP161

TYPICAL CHARACTERISTICS



Figure 20. Dropout Voltage vs. Load Current – $V_{OUT} = 5.14\text{ V}$



Figure 21. Dropout Voltage vs. Temperature – $V_{OUT} = 1.8\text{ V}$

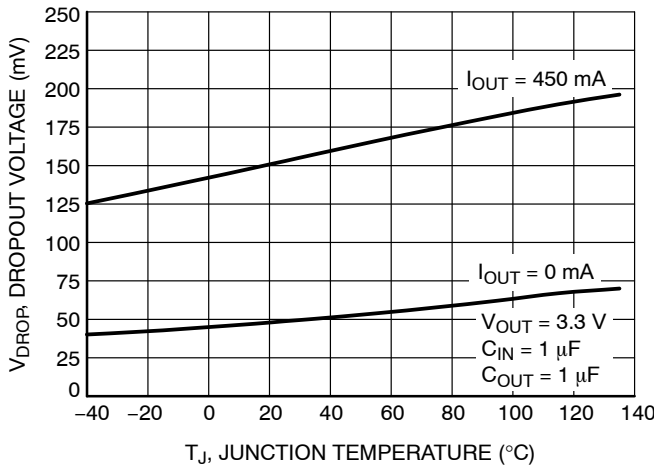

Figure 22. Dropout Voltage vs. Temperature – $V_{OUT} = 3.3\text{ V}$

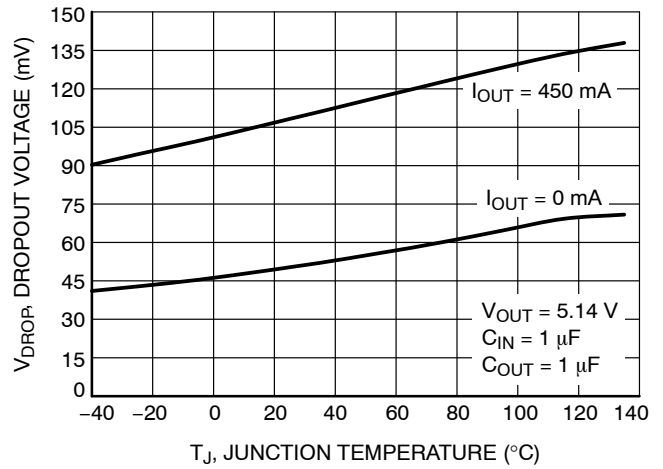

Figure 23. Dropout Voltage vs. Temperature – $V_{OUT} = 5.14\text{ V}$



**Figure 24. Dropout Voltage vs. Temperature
 $V_{OUT} = 1.8\text{ V}$**

NCP161

TYPICAL CHARACTERISTICS



Figure 25. Current Limit vs. Temperature



Figure 26. Short Circuit Current vs. Temperature



Figure 27. Enable Threshold Voltage vs. Temperature



Figure 28. Enable Current Temperature

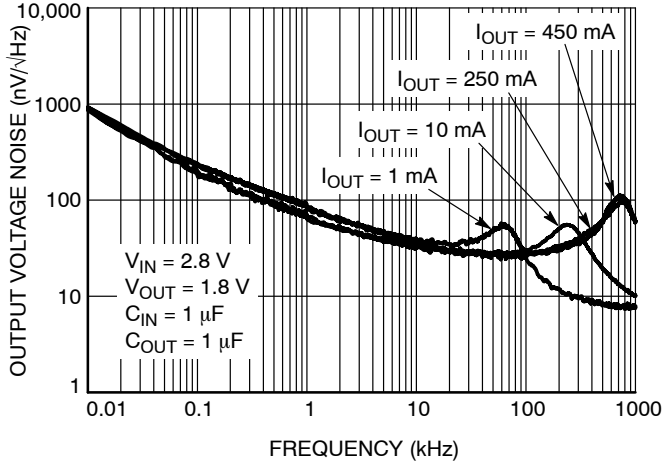

Figure 29. Disable Current vs. Temperature



Figure 30. Discharge Resistivity vs. Temperature

TYPICAL CHARACTERISTICS



I _{OUT}	RMS Output Noise (μV)	
	10 Hz – 100 kHz	100 Hz – 100 kHz
1 mA	14.62	14.10
10 mA	11.12	10.48
250 mA	10.37	9.82
450 mA	10.22	9.62

Figure 31. Output Voltage Noise Spectral Density – V_{OUT} = 1.8 V

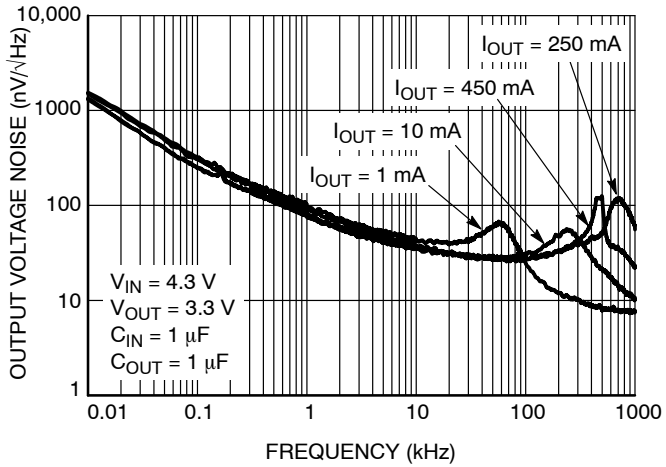

I _{OUT}	RMS Output Noise (μV)	
	10 Hz – 100 kHz	100 Hz – 100 kHz
1 mA	16.9	15.79
10 mA	12.64	11.13
250 mA	11.96	10.64
450 mA	11.50	10.40

Figure 32. Output Voltage Noise Spectral Density – V_{OUT} = 3.3 V

TYPICAL CHARACTERISTICS

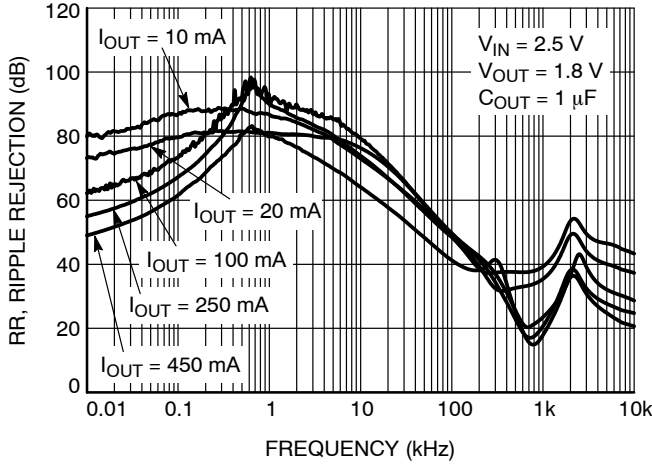

Figure 33. Power Supply Rejection Ratio, $V_{OUT} = 1.8\text{ V}$

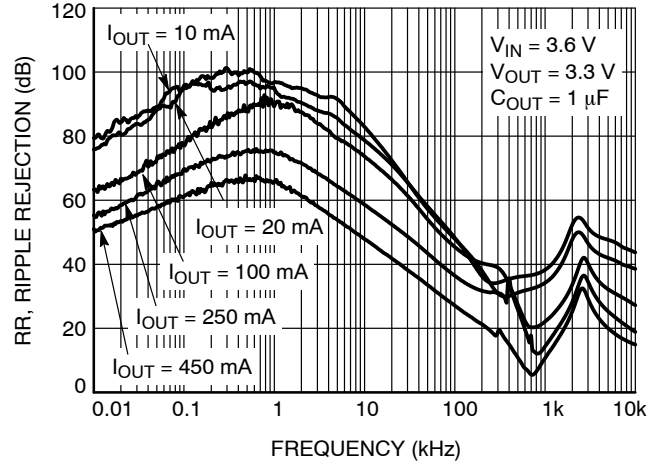

Figure 34. Power Supply Rejection Ratio, $V_{OUT} = 3.3\text{ V}$

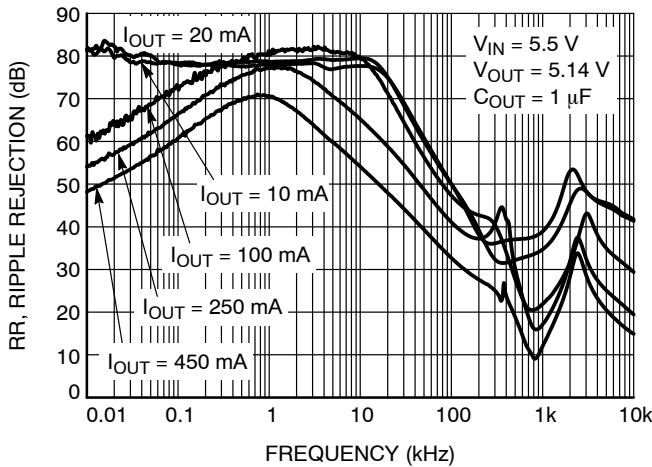

Figure 35. Power Supply Rejection Ratio, $V_{OUT} = 5.14\text{ V}$

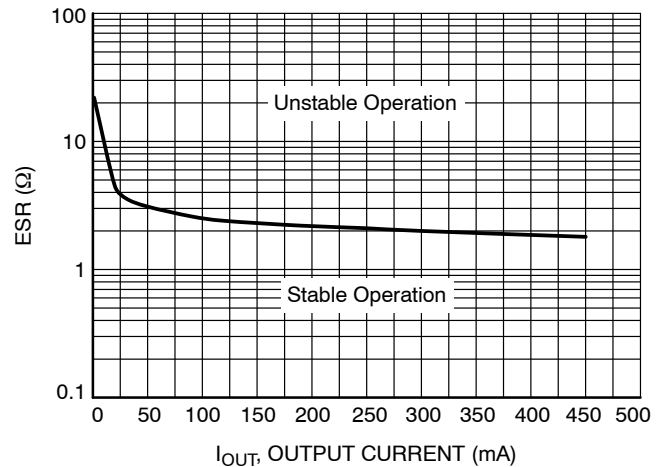

Figure 36. Stability vs. ESR



Figure 37. Enable Turn-on Response - $C_{OUT} = 1\text{ }\mu\text{F}$, $I_{OUT} = 10\text{ mA}$

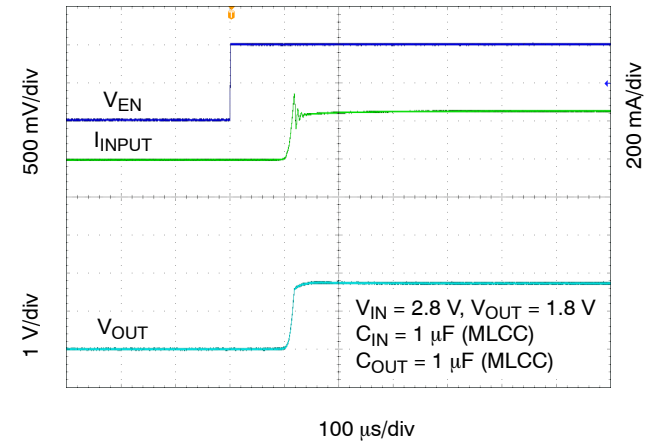

Figure 38. Enable Turn-on Response - $C_{OUT} = 1\text{ }\mu\text{F}$, $I_{OUT} = 250\text{ mA}$

TYPICAL CHARACTERISTICS

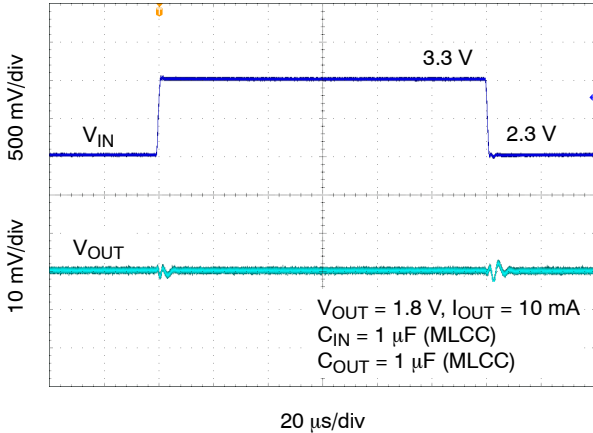

Figure 39. Line Transient Response – $V_{OUT} = 1.8\text{ V}$

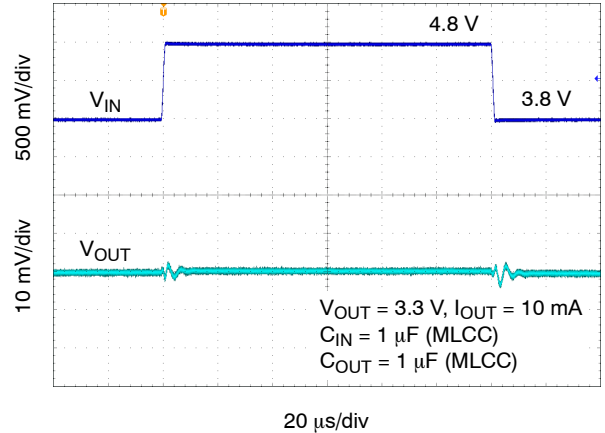

Figure 40. Line Transient Response – $V_{OUT} = 3.3\text{ V}$

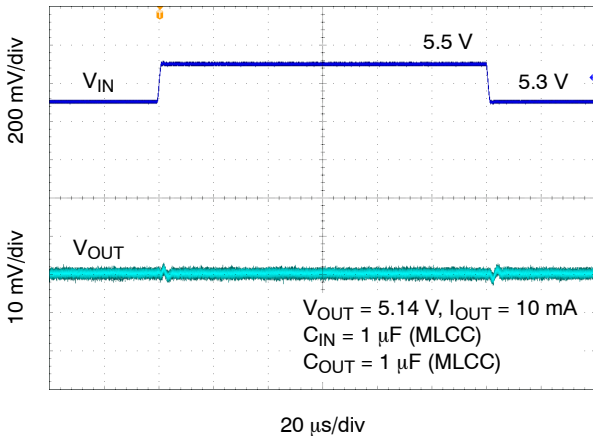

Figure 41. Line Transient Response – $V_{OUT} = 5.14\text{ V}$

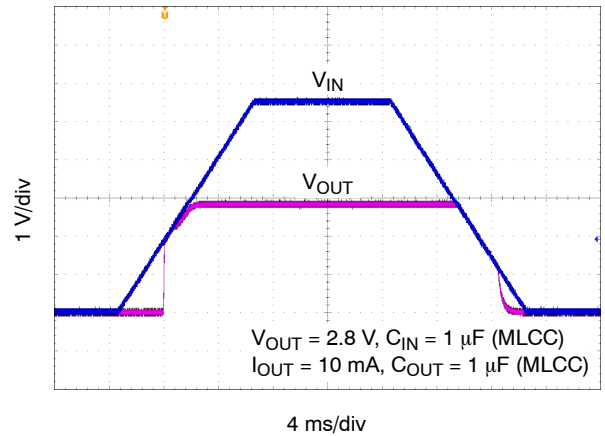

Figure 42. Turn-on/off – Slow Rising V_{IN}

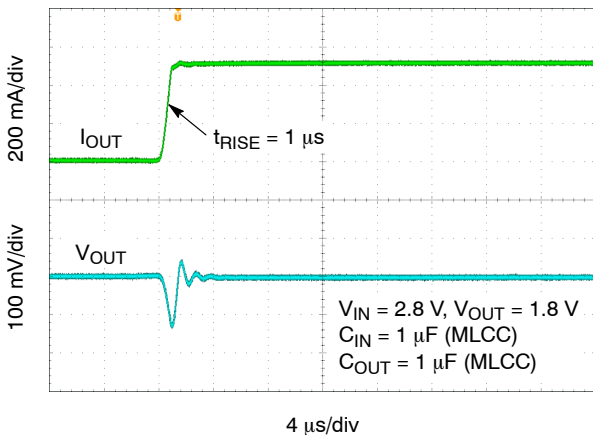

Figure 43. Load Transient Response – 1 mA to 450 mA – $V_{OUT} = 1.8\text{ V}$

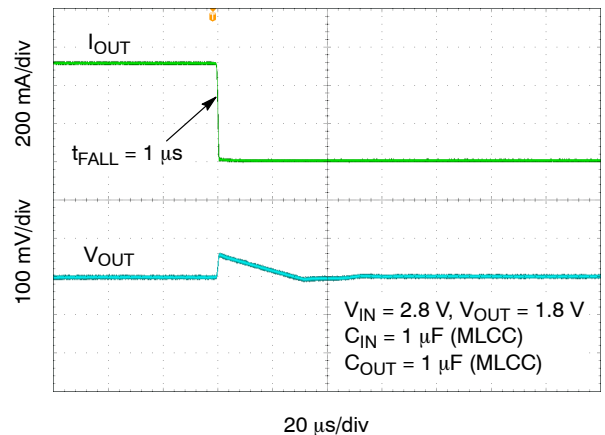

Figure 44. Load Transient Response – 450 mA to 1 mA – $V_{OUT} = 1.8\text{ V}$

TYPICAL CHARACTERISTICS



Figure 45. Load Transient Response – 1 mA to 450 mA – $V_{OUT} = 3.3\text{ V}$



Figure 46. Load Transient Response – 450 mA to 1 mA – $V_{OUT} = 3.3\text{ V}$

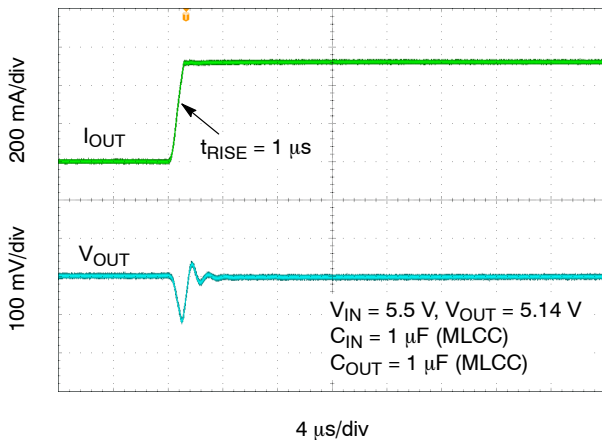

Figure 47. Load Transient Response – 1 mA to 450 mA – $V_{OUT} = 5.14\text{ V}$

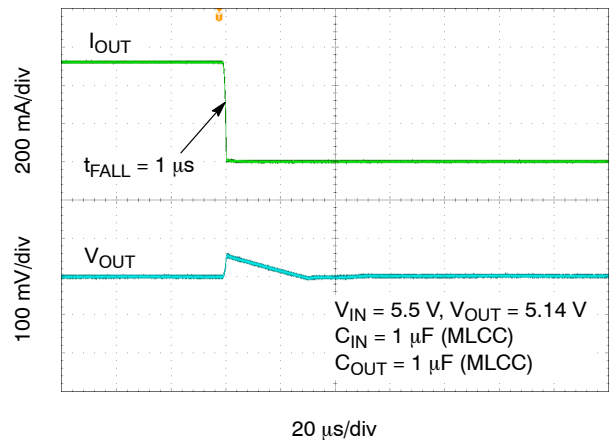

Figure 48. Load Transient Response – 450 mA to 1 mA – $V_{OUT} = 5.14\text{ V}$



Figure 49. Short Circuit and Thermal Shutdown



Figure 50. Enable Turn-off

APPLICATIONS INFORMATION

General

The NCP161 is an ultra-low noise 450 mA low dropout regulator designed to meet the requirements of RF applications and high performance analog circuits. The NCP161 device provides very high PSRR and excellent dynamic response. In connection with low quiescent current this device is well suitable for battery powered application such as cell phones, tablets and other. The NCP161 is fully protected in case of current overload, output short circuit and overheating.

Input Capacitor Selection (C_{IN})

Input capacitor connected as close as possible is necessary for ensure device stability. The X7R or X5R capacitor should be used for reliable performance over temperature range. The value of the input capacitor should be 1 μ F or greater to ensure the best dynamic performance. This capacitor will provide a low impedance path for unwanted AC signals or noise modulated onto constant input voltage. There is no requirement for the ESR of the input capacitor but it is recommended to use ceramic capacitors for their low ESR and ESL. A good input capacitor will limit the influence of input trace inductance and source resistance during sudden load current changes.

Output Decoupling (C_{OUT})

The NCP161 requires an output capacitor connected as close as possible to the output pin of the regulator. The recommended capacitor value is 1 μ F and X7R or X5R dielectric due to its low capacitance variations over the specified temperature range. The NCP161 is designed to remain stable with minimum effective capacitance of 0.7 μ F to account for changes with temperature, DC bias and package size. Especially for small package size capacitors such as 0201 the effective capacitance drops rapidly with the applied DC bias. Please refer Figure 51.

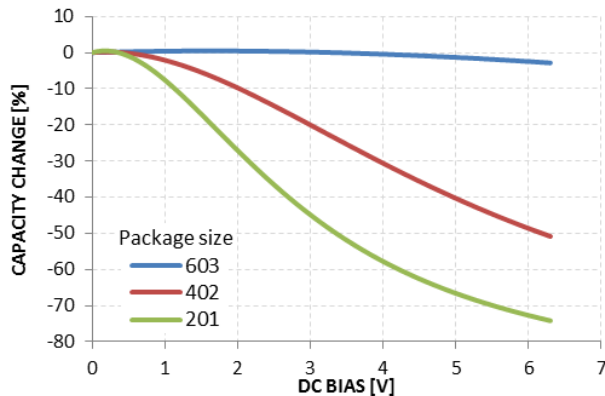

Figure 51. Capacity vs DC Bias Voltage

There is no requirement for the minimum value of Equivalent Series Resistance (ESR) for the C_{OUT} but the maximum value of ESR should be less than 2 Ω . Larger output capacitors and lower ESR could improve the load

transient response or high frequency PSRR. It is not recommended to use tantalum capacitors on the output due to their large ESR. The equivalent series resistance of tantalum capacitors is also strongly dependent on the temperature, increasing at low temperature.

Enable Operation

The NCP161 uses the EN pin to enable/disable its device and to deactivate/activate the active discharge function.

If the EN pin voltage is <0.4 V the device is guaranteed to be disabled. The pass transistor is turned-off so that there is virtually no current flow between the IN and OUT. The active discharge transistor is active so that the output voltage V_{OUT} is pulled to GND through a 280 Ω resistor. In the disable state the device consumes as low as typ. 10 nA from the V_{IN} .

If the EN pin voltage >1.2 V the device is guaranteed to be enabled. The NCP161 regulates the output voltage and the active discharge transistor is turned-off.

The EN pin has internal pull-down current source with typ. value of 200 nA which assures that the device is turned-off when the EN pin is not connected. In the case where the EN function isn't required the EN should be tied directly to IN.

Output Current Limit

Output Current is internally limited within the IC to a typical 700 mA. The NCP161 will source this amount of current measured with a voltage drops on the 90% of the nominal V_{OUT} . If the Output Voltage is directly shorted to ground ($V_{OUT} = 0$ V), the short circuit protection will limit the output current to 690 mA (typ). The current limit and short circuit protection will work properly over whole temperature range and also input voltage range. There is no limitation for the short circuit duration.

Thermal Shutdown

When the die temperature exceeds the Thermal Shutdown threshold ($T_{SD} - 160^{\circ}\text{C}$ typical), Thermal Shutdown event is detected and the device is disabled. The IC will remain in this state until the die temperature decreases below the Thermal Shutdown Reset threshold ($T_{SDR} - 140^{\circ}\text{C}$ typical). Once the IC temperature falls below the 140°C the LDO is enabled again. The thermal shutdown feature provides the protection from a catastrophic device failure due to accidental overheating. This protection is not intended to be used as a substitute for proper heat sinking.

Power Dissipation

As power dissipated in the NCP161 increases, it might become necessary to provide some thermal relief. The maximum power dissipation supported by the device is dependent upon board design and layout. Mounting pad configuration on the PCB, the board material, and the

NCP161

ambient temperature affect the rate of junction temperature rise for the part.

The maximum power dissipation the NCP161 can handle is given by:

$$P_{D(MAX)} = \frac{[125^{\circ}\text{C} - T_A]}{\theta_{JA}} \quad (\text{eq. 1})$$

The power dissipated by the NCP161 for given application conditions can be calculated from the following equations:

$$P_D \approx V_{IN} \cdot I_{GND} + I_{OUT}(V_{IN} - V_{OUT}) \quad (\text{eq. 2})$$

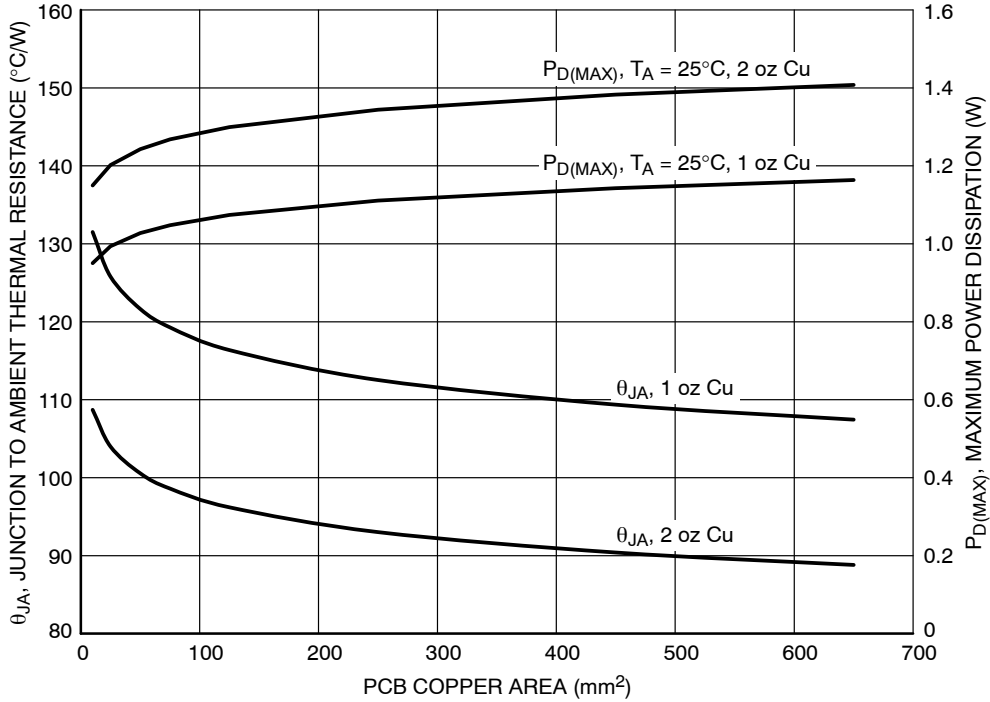

Figure 52. θ_{JA} and $P_D (MAX)$ vs. Copper Area (CSP4)

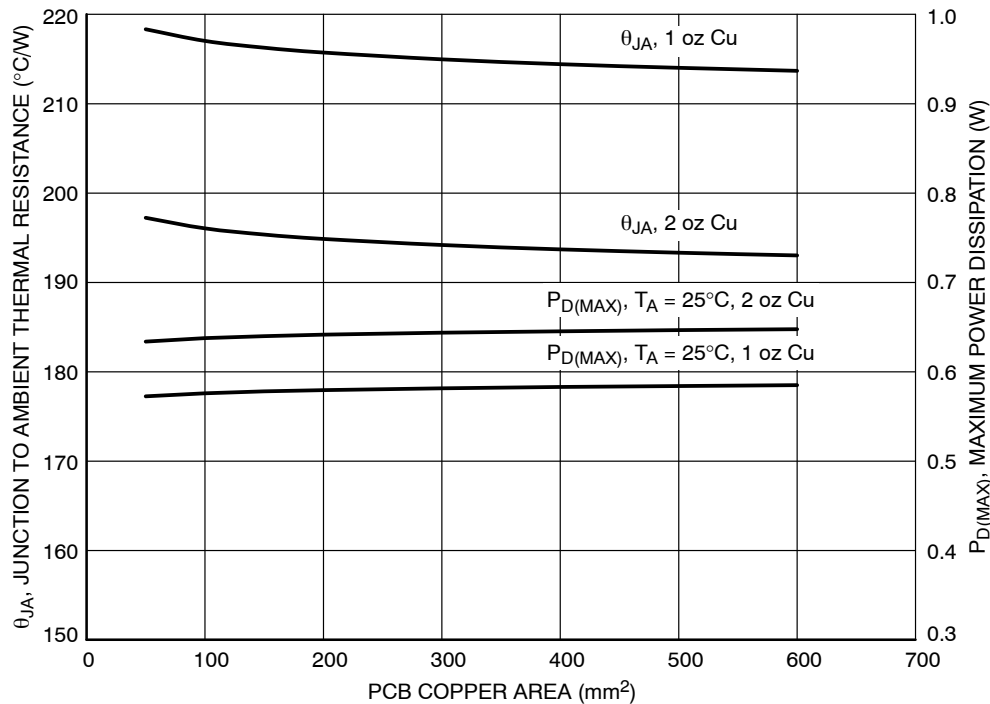

Figure 53. θ_{JA} and $P_D (MAX)$ vs. Copper Area (XDFN4)

NCP161

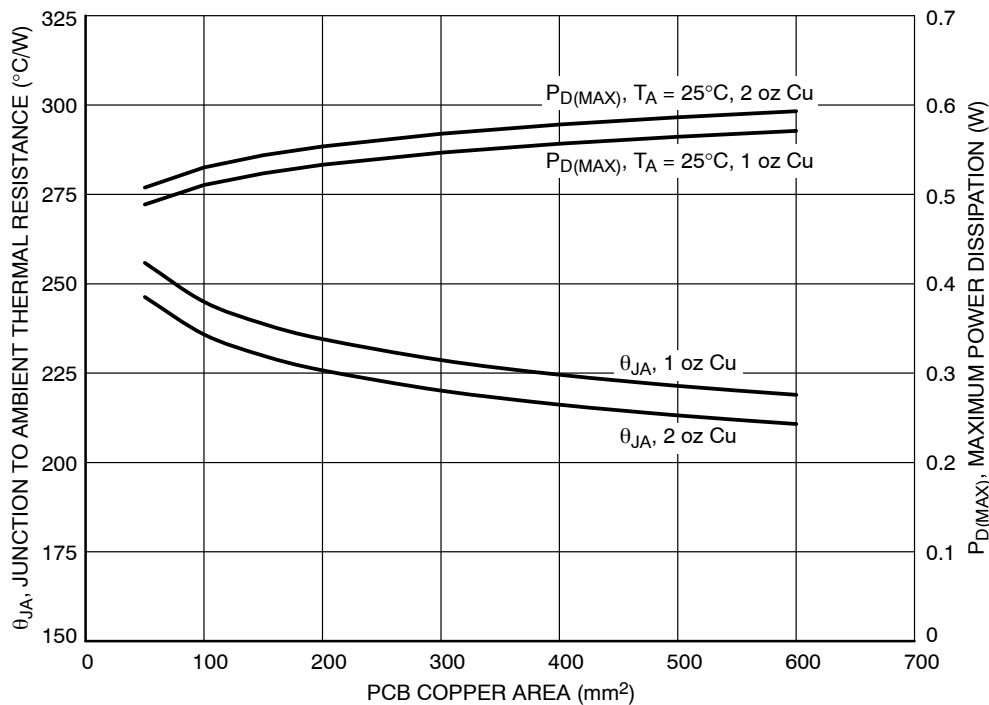

Figure 54. θ_{JA} and $P_{D(MAX)}$ vs. Copper Area (SOT23-5)

Reverse Current

The PMOS pass transistor has an inherent body diode which will be forward biased in the case that $V_{OUT} > V_{IN}$. Due to this fact in cases, where the extended reverse current condition can be anticipated the device may require additional external protection.

Power Supply Rejection Ratio

The NCP161 features very high Power Supply Rejection ratio. If desired the PSRR at higher frequencies in the range 100 kHz – 10 MHz can be tuned by the selection of C_{OUT} capacitor and proper PCB layout.

Turn-On Time

The turn-on time is defined as the time period from EN assertion to the point in which V_{OUT} will reach 98% of its nominal value. This time is dependent on various application conditions such as $V_{OUT(NOM)}$, C_{OUT} , T_A .

PCB Layout Recommendations

To obtain good transient performance and good regulation characteristics place C_{IN} and C_{OUT} capacitors close to the device pins and make the PCB traces wide. In order to minimize the solution size, use 0402 or 0201 capacitors with appropriate capacity. Larger copper area connected to the pins will also improve the device thermal resistance. The actual power dissipation can be calculated from the equation above (Equation 2). Expose pad can be tied to the GND pin for improvement power dissipation and lower device temperature.

NCP161

ORDERING INFORMATION

Device	Nominal Output Voltage	Description	Marking	Rotation	Package	Shipping†
NCP161AFCS180T2G	1.8 V	450 mA, Active Discharge	A	180°	WLCSP4 CASE 567KA* (Pb-Free)	5000 / Tape & Reel
NCP161AFCS250T2G	2.5 V		D	180°		
NCP161AFCS270T2G (Consult onsemi Sales)	2.7 V		V	180°		
NCP161AFCS280T2G	2.8 V		E	180°		
NCP161AFCS285T2G	2.85 V		F	180°		
NCP161AFCS300T2G	3.0 V		J	180°		
NCP161AFCS320T2G	3.2 V		T	180°		
NCP161AFCS330T2G	3.3 V		K	180°		
NCP161AFCS350T2G	3.5 V		L	180°		
NCP161AFCS450T2G	4.5 V		P	180°		
NCP161AFCS500T2G	5.0 V		R	180°		
NCP161AFCS514T2G	5.14 V		Q	180°		
NCP161BFCS180T2G (Consult onsemi Sales)	1.8 V	450 mA, Non-Active Discharge	A	270°	WLCSP4 CASE 567KA* (Pb-Free)	5000 / Tape & Reel
NCP161BFCS250T2G	2.5 V		D	270°		
NCP161BFCS280T2G (Consult onsemi Sales)	2.8 V		E	270°		
NCP161BFCS285T2G (Consult onsemi Sales)	2.85 V		F	270°		
NCP161BFCS300T2G (Consult onsemi Sales)	3.0 V		J	270°		
NCP161BFCS330T2G	3.3 V		K	270°		
NCP161BFCS350T2G	3.5 V		L	270°		
NCP161BFCS450T2G	4.5 V		P	270°		
NCP161BFCS500T2G (Consult onsemi Sales)	5.0 V		R	270°		
NCP161BFCS514T2G (Consult onsemi Sales)	5.14 V		Q	270°		

*UBM = 180 μm (±5 μm)

7. Product processed after April 1, 2023 are shipped with quantity 10000 units / tape & reel.

NCP161

ORDERING INFORMATION

Device	Nominal Output Voltage	Description	Marking	Rotation	Package	Shipping†		
NCP161AFCT180T2G	1.8 V	450 mA, Active Discharge	A	180°	WLCSP4 CASE 567JZ (Pb-Free)	5000 or 10000 / Tape & Reel (Note 7)		
NCP161AFCT185T2G (Consult onsemi Sales)	1.85 V		V	180°				
NCP161AFCT250T2G (Consult onsemi Sales)	2.5 V		D	180°				
NCP161AFCT280T2G	2.8 V		E	180°				
NCP161AFCT285T2G (Consult onsemi Sales)	2.85 V		F	180°				
NCP161AFCT290T2G (Consult onsemi Sales)	2.9 V		T	180°				
NCP161AFCT300T2G	3.0 V		J	180°				
NCP161AFCT310T2G (Consult onsemi Sales)	3.1 V		6	180°				
NCP161AFCT330T2G	3.3 V		K	180°				
NCP161AFCT350T2G (Consult onsemi Sales)	3.5 V		L	180°				
NCP161AFCT450T2G	4.5 V		P	180°				
NCP161AFCT500T2G (Consult onsemi Sales)	5.0 V		R	180°				
NCP161AFCT514T2G	5.14 V		Q	180°				
NCP161AFCTC280T2G	2.8 V	450 mA, Active Discharge, Backside Coating	E	180°	WLCSP4 CASE 567JZ (Pb-Free)	5000 or 10000 / Tape & Reel (Note 7)		
NCP161AFCTC350T2G (Consult onsemi Sales)	3.5 V		L	180°				
NCP161BFCT180T2G	1.8 V	450 mA, Non-Active Discharge	A	270°			WLCSP4 CASE 567JZ (Pb-Free)	5000 or 10000 / Tape & Reel (Note 7)
NCP161BFCT185T2G (Consult onsemi Sales)	1.85 V		V	270°				
NCP161BFCT250T2G	2.5 V		D	270°				
NCP161BFCT280T2G	2.8 V		E	270°				
NCP161BFCT285T2G (Consult onsemi Sales)	2.85 V		F	270°				
NCP161BFCT300T2G (Consult onsemi Sales)	3.0 V		J	270°				
NCP161BFCT330T2G (Consult onsemi Sales)	3.3 V		K	270°				
NCP161BFCT350T2G (Consult onsemi Sales)	3.5 V		L	270°				
NCP161BFCT450T2G (Consult onsemi Sales)	4.5 V		P	270°				
NCP161BFCT500T2G	5.0 V		R	270°				
NCP161BFCT514T2G (Consult onsemi Sales)	5.14 V		Q	270°				

*UBM = 180 μm (±5 μm)

7. Product processed after April 1, 2023 are shipped with quantity 10000 units / tape & reel.

NCP161

ORDERING INFORMATION (continued)

Device	Nominal Output Voltage	Description	Marking	Package	Shipping [†]
NCP161AMX180TBG (Note 8)	1.8 V	450 mA, Active Discharge	DN	XDFN4 (Pb-Free)	3000 or 5000 / Tape & Reel (Note 8)
NCP161AMX185TBG (Note 8)	1.85 V		EY		
NCP161AMX250TBG	2.5 V		DP		
NCP161AMX280TBG (Note 8)	2.8 V		DQ		
NCP161AMX285TBG	2.85 V		DR		
NCP161AMX300TBG (Note 8)	3.0 V		DT		
NCP161AMX320TBG (Note 8)	3.2 V		DZ		
NCP161AMX330TBG (Note 8)	3.3 V		DD		
NCP161AMX350TBG	3.5 V		DU		
NCP161AMX450TBG	4.5 V		DV		
NCP161AMX500TBG	5.0 V		DX		
NCP161AMX514TBG (Note 8)	5.14 V		DE		
NCP161BMX180TBG (Note 8)	1.8 V	450 mA, Non-Active Discharge	EN	XDFN4 (Pb-Free)	3000 or 5000 / Tape & Reel (Note 8)
NCP161BMX250TBG (Note 8)	2.5 V		EP		
NCP161BMX280TBG (Note 8)	2.8 V		EQ		
NCP161BMX285TBG	2.85 V		ER		
NCP161BMX300TBG	3.0 V		ET		
NCP161BMX330TBG (Note 8)	3.3 V		ED		
NCP161BMX350TBG (Note 8)	3.5 V		EU		
NCP161BMX450TBG	4.5 V		EV		
NCP161BMX500TBG	5.0 V		EX		
NCP161BMX514TBG (Note 8)	5.14 V		EE		
NCP161ASN180T1G	1.8 V	450 mA, Active Discharge	JAF	SOT23-5L (Pb-Free)	3000 / Tape & Reel
NCP161ASN250T1G	2.5 V		JAA		
NCP161ASN280T1G	2.8 V		JAC		
NCP161ASN300T1G	3.0 V		JAD		
NCP161ASN330T1G	3.3 V		JAG		
NCP161ASN350T1G	3.5 V		JAH		
NCP161ASN500T1G	5.0 V		JAE		

[†]For information on tape and reel specifications, including part orientation and tape sizes, please refer to our Tape and Reel Packaging Specifications Brochure, [BRD8011/D](#).

8. Product processed after October 1, 2022 are shipped with quantity 5000 units / tape & reel.

MECHANICAL CASE OUTLINE PACKAGE DIMENSIONS

ON Semiconductor®



SOT-23, 5 Lead CASE 527AH ISSUE A

DATE 09 JUN 2021



NOTES:

1. DIMENSIONING AND TOLERANCING PER ASME Y14.5M, 1989A
2. CONTROLLING DIMENSION: MILLIMETERS
3. MAXIMUM LEAD THICKNESS INCLUDES LEAD FINISH THICKNESS. MINIMUM LEAD THICKNESS IS THE MINIMUM THICKNESS OF THE BASE MATERIAL.
4. DIMENSIONS D AND E1 DO NOT INCLUDE MOLD FLASH, PROTRUSIONS, OR GATE BURRS. MOLD FLASH, PROTRUSIONS, OR GATE BURRS SHALL NOT EXCEED 0.25 PER SIDE. D AND E1 DIMENSIONS ARE DETERMINED AT DATUM D.
5. DIMENSION 'b' DOES NOT INCLUDE DAMBAR PROTRUSION. ALLOWABLE DAMBAR PROTRUSION SHALL BE 0.08mm TOTAL IN EXCESS OF THE 'b' DIMENSION AT MAXIMUM MATERIAL CONDITION. MINIMUM SPACE BETWEEN PROTRUSION AND AN ADJACENT LEAD SHALL NOT BE LESS THAN 0.07mm.



DIM	MILLIMETERS		
	MIN.	NOM.	MAX.
A	0.90	—	1.45
A1	0.00	—	0.15
A2	0.90	1.15	1.30
b	0.30	—	0.50
c	0.08	—	0.22
D	2.90 BSC		
E	2.80 BSC		
E1	1.60 BSC		
e	0.95 BSC		
L	0.30	0.45	0.60
L1	0.60 REF		
L2	0.25 REF		
theta	0°	4°	8°
theta1	0°	10°	15°
theta2	0°	10°	15°

GENERIC MARKING DIAGRAM*



XXX = Specific Device Code
M = Date Code

*This information is generic. Please refer to device data sheet for actual part marking. Pb-Free indicator, "G" or microdot "•", may or may not be present. Some products may not follow the Generic Marking.

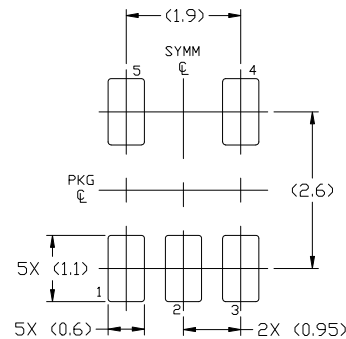

RECOMMENDED MOUNTING FOOTPRINT

For additional information on our Pb-Free strategy and soldering details, please download the ON Semiconductor Soldering and Mounting Techniques Reference Manual, SOLDERRM/D.

DOCUMENT NUMBER:	98AON34320E	Electronic versions are uncontrolled except when accessed directly from the Document Repository. Printed versions are uncontrolled except when stamped "CONTROLLED COPY" in red.
DESCRIPTION:	SOT-23, 5 LEAD	PAGE 1 OF 1

ON Semiconductor and ON are trademarks of Semiconductor Components Industries, LLC dba ON Semiconductor or its subsidiaries in the United States and/or other countries. ON Semiconductor reserves the right to make changes without further notice to any products herein. ON Semiconductor makes no warranty, representation or guarantee regarding the suitability of its products for any particular purpose, nor does ON Semiconductor assume any liability arising out of the application or use of any product or circuit, and specifically disclaims any and all liability, including without limitation special, consequential or incidental damages. ON Semiconductor does not convey any license under its patent rights nor the rights of others.

MECHANICAL CASE OUTLINE

PACKAGE DIMENSIONS



WLCSP4, 0.64x0.64x0.33
CASE 567JZ
ISSUE B

DATE 16 MAY 2022



TOP VIEW

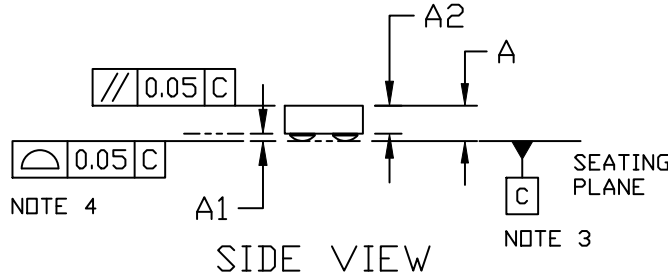

SIDE VIEW

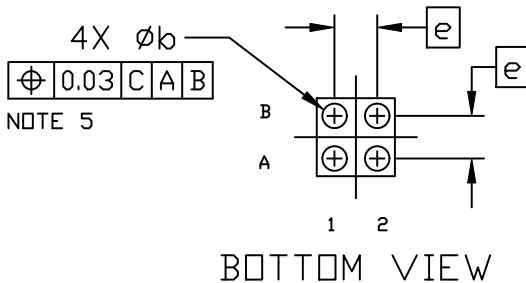

BOTTOM VIEW

GENERIC MARKING DIAGRAM*



X = Specific Device Code
M = Date Code

*This information is generic. Please refer to device data sheet for actual part marking. Pb-Free indicator, "G" or microdot "▪", may or may not be present. Some products may not follow the Generic Marking.

NOTES:

1. DIMENSIONING AND TOLERANCING PER ASME Y14.5M, 2009.
2. CONTROLLING DIMENSION: MILLIMETERS
3. DATUM C, THE SEATING PLANE, IS DEFINED BY THE SPHERICAL CROWNS OF THE SOLDER BUMPS.
4. COPLANARITY APPLIES TO THE SPHERICAL CROWNS OF THE SOLDER BUMPS.
5. DIMENSION *b* IS MEASURED AT THE MAXIMUM SOLDER BALL DIAMETER PARALLEL TO DATUM C.

DIM	MILLIMETERS		
	MIN.	NOM.	MAX.
A	---	---	0.33
A1	0.04	0.06	0.08
A2	0.23 REF		
<i>b</i>	0.180	0.200	0.220
D	0.610	0.640	0.670
E	0.610	0.640	0.670
<i>e</i>	0.35 BSC		

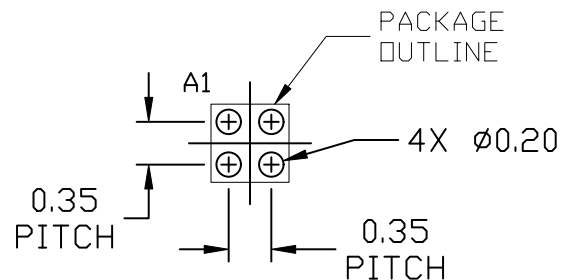

RECOMMENDED MOUNTING FOOTPRINT * (NSMD PAD TYPE)

* For additional information on our Pb-Free strategy and soldering details, please download the ON Semiconductor Soldering and Mounting Techniques Reference Manual, SOLDERRM/D.

DOCUMENT NUMBER:	98AON85781F	Electronic versions are uncontrolled except when accessed directly from the Document Repository. Printed versions are uncontrolled except when stamped "CONTROLLED COPY" in red.
DESCRIPTION:	WLCSP4, 0.64X0.64x0.33	PAGE 1 OF 1

onsemi and ONSEMI are trademarks of Semiconductor Components Industries, LLC dba onsemi or its subsidiaries in the United States and/or other countries. onsemi reserves the right to make changes without further notice to any products herein. onsemi makes no warranty, representation or guarantee regarding the suitability of its products for any particular purpose, nor does onsemi assume any liability arising out of the application or use of any product or circuit, and specifically disclaims any and all liability, including without limitation special, consequential or incidental damages. onsemi does not convey any license under its patent rights nor the rights of others.



SCALE 4:1

WLCSP4, 0.64x0.64
CASE 567KA
ISSUE B

DATE 24 MAR 2020



GENERIC MARKING DIAGRAM*



X = Specific Device Code
M = Date Code

This information is generic. Please refer to device data sheet for actual part marking. Pb-Free indicator, "G" or microdot "", may or may not be present. Some products may not follow the Generic Marking.

NOTES:

1. DIMENSIONING AND TOLERANCING PER ASME Y14.5M, 2009.
2. CONTROLLING DIMENSION: MILLIMETERS
3. DATUM C, THE SEATING PLANE, IS DEFINED BY THE SPHERICAL CROWNS OF THE CONTACT BALLS.
4. COPLANARITY APPLIES TO THE SPHERICAL CROWNS OF THE CONTACT BALLS.
5. DIMENSION b IS MEASURED AT THE MAXIMUM CONTACT BALL DIAMETER PARALLEL TO DATUM C.

DIM	MILLIMETERS		
	MIN.	NOM.	MAX.
A	0.355	0.405	0.455
A1	0.13	0.15	0.17
A2	0.255 REF		
b	0.167	0.187	0.207
D	0.610	0.640	0.670
E	0.610	0.640	0.670
e	0.35 BSC		



RECOMMENDED MOUNTING FOOTPRINT* (NSMD PAD TYPE)

* For additional information on our Pb-Free strategy and soldering details, please download the ON Semiconductor Soldering and Mounting Techniques Reference Manual, SOLDERRM/D.

DOCUMENT NUMBER:	98AON85783F	Electronic versions are uncontrolled except when accessed directly from the Document Repository. Printed versions are uncontrolled except when stamped "CONTROLLED COPY" in red.
DESCRIPTION:	WLCSP4, 0.64X0.64	PAGE 1 OF 1

ON Semiconductor and are trademarks of Semiconductor Components Industries, LLC dba ON Semiconductor or its subsidiaries in the United States and/or other countries. ON Semiconductor reserves the right to make changes without further notice to any products herein. ON Semiconductor makes no warranty, representation or guarantee regarding the suitability of its products for any particular purpose, nor does ON Semiconductor assume any liability arising out of the application or use of any product or circuit, and specifically disclaims any and all liability, including without limitation special, consequential or incidental damages. ON Semiconductor does not convey any license under its patent rights nor the rights of others.

MECHANICAL CASE OUTLINE PACKAGE DIMENSIONS



XDFN4 1.0x1.0, 0.65P
CASE 711AJ
ISSUE C

DATE 08 MAR 2022



NOTES:

1. DIMENSIONING AND TOLERANCING PER ASME Y14.5M, 1994.
2. CONTROLLING DIMENSION: MILLIMETERS
3. DIMENSION *b* APPLIES TO THE PLATED TERMINALS AND IS MEASURED BETWEEN 0.15 AND 0.20 FROM THE TERMINAL TIPS.
4. COPLANARITY APPLIES TO THE EXPOSED PAD AS WELL AS THE TERMINALS.

DIM	MILLIMETERS		
	MIN	NOM	MAX
A	0.33	0.38	0.43
A1	0.00	---	0.05
A3	0.10 REF		
<i>b</i>	0.15	0.20	0.25
<i>b</i> 2	0.02	0.07	0.12
D	0.90	1.00	1.10
D2	0.43	0.48	0.53
E	0.90	1.00	1.10
<i>e</i>	0.65 BSC		
L	0.20		0.30
L2	0.07		0.17

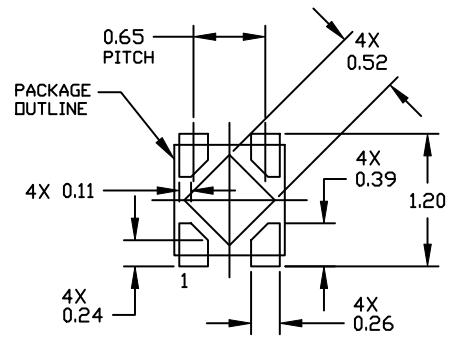
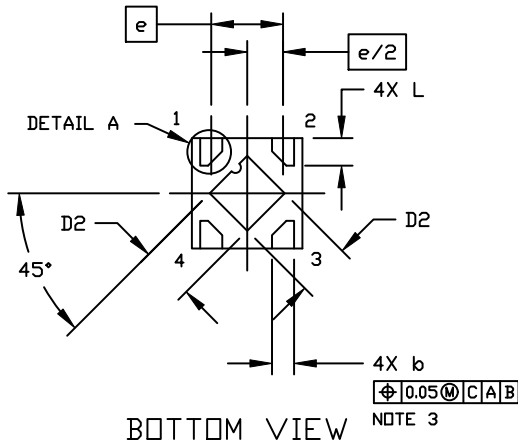

**RECOMMENDED
MOUNTING FOOTPRINT**

* FOR ADDITIONAL INFORMATION ON OUR Pb-FREE STRATEGY AND SOLDERING DETAILS, PLEASE DOWNLOAD THE ONSEMI SOLDERING AND MOUNT TECHNIQUES REFERENCE MANUAL, SOLDERRM/D

GENERIC MARKING DIAGRAM*

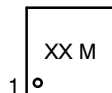

XX = Specific Device Code
M = Date Code

*This information is generic. Please refer to device data sheet for actual part marking. Pb-Free indicator, "G" or microdot "•", may or may not be present. Some products may not follow the Generic Marking.

DOCUMENT NUMBER:	98AON67179E	Electronic versions are uncontrolled except when accessed directly from the Document Repository. Printed versions are uncontrolled except when stamped "CONTROLLED COPY" in red.
DESCRIPTION:	XDFN4, 1.0X1.0, 0.65P	PAGE 1 OF 1

onsemi and ONSEMI are trademarks of Semiconductor Components Industries, LLC dba onsemi or its subsidiaries in the United States and/or other countries. onsemi reserves the right to make changes without further notice to any products herein. onsemi makes no warranty, representation or guarantee regarding the suitability of its products for any particular purpose, nor does onsemi assume any liability arising out of the application or use of any product or circuit, and specifically disclaims any and all liability, including without limitation special, consequential or incidental damages. onsemi does not convey any license under its patent rights nor the rights of others.

onsemi, **Onsemi**, and other names, marks, and brands are registered and/or common law trademarks of Semiconductor Components Industries, LLC dba "**onsemi**" or its affiliates and/or subsidiaries in the United States and/or other countries. **onsemi** owns the rights to a number of patents, trademarks, copyrights, trade secrets, and other intellectual property. A listing of **onsemi**'s product/patent coverage may be accessed at www.onsemi.com/site/pdf/Patent-Marking.pdf. **onsemi** reserves the right to make changes at any time to any products or information herein, without notice. The information herein is provided "as-is" and **onsemi** makes no warranty, representation or guarantee regarding the accuracy of the information, product features, availability, functionality, or suitability of its products for any particular purpose, nor does **onsemi** assume any liability arising out of the application or use of any product or circuit, and specifically disclaims any and all liability, including without limitation special, consequential or incidental damages. Buyer is responsible for its products and applications using **onsemi** products, including compliance with all laws, regulations and safety requirements or standards, regardless of any support or applications information provided by **onsemi**. "Typical" parameters which may be provided in **onsemi** data sheets and/or specifications can and do vary in different applications and actual performance may vary over time. All operating parameters, including "Typicals" must be validated for each customer application by customer's technical experts. **onsemi** does not convey any license under any of its intellectual property rights nor the rights of others. **onsemi** products are not designed, intended, or authorized for use as a critical component in life support systems or any FDA Class 3 medical devices or medical devices with a same or similar classification in a foreign jurisdiction or any devices intended for implantation in the human body. Should Buyer purchase or use **onsemi** products for any such unintended or unauthorized application, Buyer shall indemnify and hold **onsemi** and its officers, employees, subsidiaries, affiliates, and distributors harmless against all claims, costs, damages, and expenses, and reasonable attorney fees arising out of, directly or indirectly, any claim of personal injury or death associated with such unintended or unauthorized use, even if such claim alleges that **onsemi** was negligent regarding the design or manufacture of the part. **onsemi** is an Equal Opportunity/Affirmative Action Employer. This literature is subject to all applicable copyright laws and is not for resale in any manner.

ADDITIONAL INFORMATION

TECHNICAL PUBLICATIONS:

Technical Library: www.onsemi.com/design/resources/technical-documentation
onsemi Website: www.onsemi.com

ONLINE SUPPORT: www.onsemi.com/support

For additional information, please contact your local Sales Representative at www.onsemi.com/support/sales

Looking for pricing, stock, or lifecycle information?

Click below to explore more details on WIN SOURCE:

 [View NCP161AFCS330T2G on WIN SOURCE](#)

 [ON Semiconductor](#) Information

Optimize Your Supply Chain with WIN SOURCE Solutions

-  Global Sourcing Solution
-  Obsolete Management
-  Cost Control Management
-  Shortage Management
-  Alternative Solution
-  Excess Inventory Management