



THE DATASHEET OF NCP717AMX280TCG



NCP717

300 mA, Very-Low Quiescent Current, I_Q 25 μ A, Low Noise, Low Dropout Regulator

The NCP717 is 300 mA LDO that provides the engineer with a very stable, accurate voltage with very low noise suitable for space constrained, noise sensitive applications. In order to optimize performance for battery operated portable applications, the NCP717 employs the dynamic quiescent current adjustment for very low I_Q consumption at no-load.

Features

- Operating Input Voltage Range: 1.8 V to 5.5 V
- Available in Fixed Voltage Options: 0.8 V to 5 V
Contact Factory for Other Voltage Options
- Very Low Quiescent Current of Typ. 25 μ A
- Very Low Noise: 22 μ V_{RMS} from 100 Hz to 100 kHz
- Low Dropout: 175 mV Typical at 300 mA
- \pm 2% Accuracy Over Load/Line/Temperature
- High Power Supply Ripple Rejection: 70 dB at 1 kHz
- Thermal Shutdown and Current Limit Protections
- Stable with a 1 μ F Ceramic Output Capacitor
- Available in XDFN 1.0 x 1.0 mm Package
- These are Pb-Free Devices

Typical Applications

- PDAs, Mobile phones, GPS, Smartphones
- Wireless Handsets, Wireless LAN, Bluetooth®, Zigbee®
- Portable Medical Equipment
- Other Battery Powered Applications

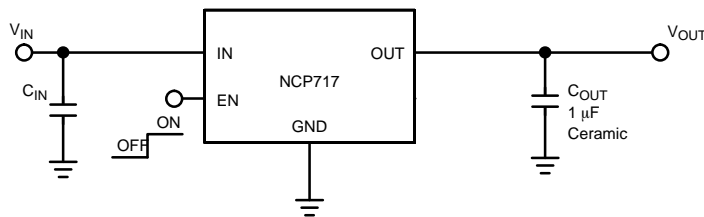

Figure 1. Typical Application Schematic



ON Semiconductor®

www.onsemi.com



XDFN4
MX SUFFIX
CASE 711AJ

MARKING DIAGRAM

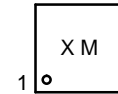

X = Specific Device Code
M = Date Code

PIN CONNECTION

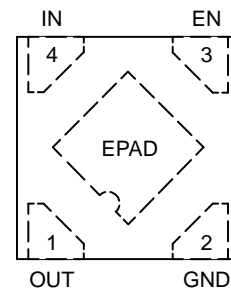

(Top View)

ORDERING INFORMATION

See detailed ordering and shipping information in the package dimensions section on page 15 of this data sheet.

NCP717

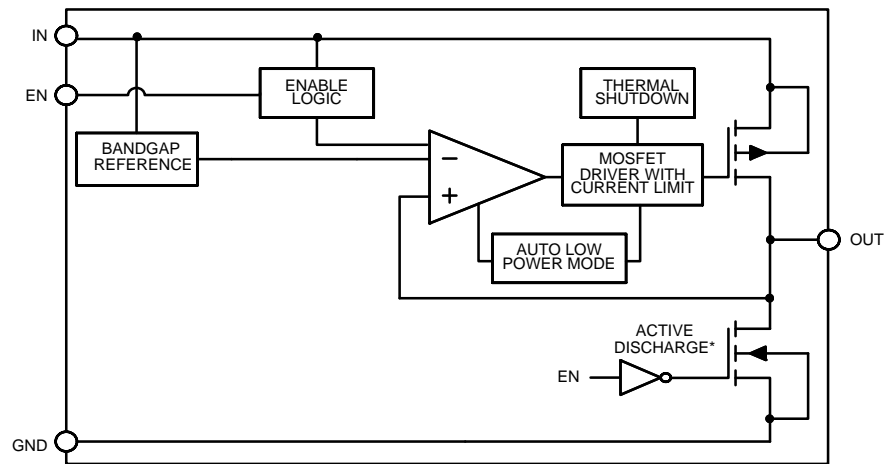

*Active output discharge function is present only in NCP717AMXyyyTCG and NCP717CMXyyyTCG devices. yyy denotes the particular V_{OUT} option.

Figure 2. Simplified Schematic Block Diagram

PIN FUNCTION DESCRIPTION

Pin No.	Pin Name	Description
1	OUT	Regulated output voltage pin. A small ceramic capacitor with minimum value of 1 μF is needed from this pin to ground to assure stability.
2	GND	Power supply ground.
3	EN	Driving EN over 0.9 V turns on the regulator. Driving EN below 0.4 V puts the regulator into shutdown mode.
4	IN	Input pin. A small capacitor is needed from this pin to ground to assure stability.
-	EPAD	Exposed pad should be connected directly to the GND pin. Soldered to a large ground copper plane allows for effective heat removal.

ABSOLUTE MAXIMUM RATINGS

Rating	Symbol	Value	Unit
Input Voltage (Note 1)	V_{IN}	-0.3 V to 6 V	V
Output Voltage	V_{OUT}	-0.3 V to $V_{IN} + 0.3$ V	V
Enable Input	V_{EN}	-0.3 V to $V_{IN} + 0.3$ V	V
Output Short Circuit Duration	t _{SC}	∞	s
Maximum Junction Temperature	$T_{J(MAX)}$	150	$^{\circ}\text{C}$
Storage Temperature	T_{STG}	-55 to 150	$^{\circ}\text{C}$
ESD Capability, Human Body Model (Note 2)	ESD_{HBM}	2000	V
ESD Capability, Machine Model (Note 2)	ESD_{MM}	200	V

Stresses exceeding those listed in the Maximum Ratings table may damage the device. If any of these limits are exceeded, device functionality should not be assumed, damage may occur and reliability may be affected.

1. Refer to ELECTRICAL CHARACTERISTICS and APPLICATION INFORMATION for Safe Operating Area.

2. This device series incorporates ESD protection and is tested by the following methods:

ESD Human Body Model tested per EIA/JESD22-A114,

ESD Machine Model tested per EIA/JESD22-A115,

Latchup Current Maximum Rating tested per JEDEC standard: JESD78.

THERMAL CHARACTERISTICS

Rating	Symbol	Value	Unit
Thermal Characteristics, XDFN4 1x1 mm Thermal Resistance, Junction-to-Air	$R_{\theta JA}$	250	$^{\circ}\text{C}/\text{W}$

NCP717

ELECTRICAL CHARACTERISTICS

−40°C ≤ T_J ≤ 125°C; V_{IN} = V_{OUT(NOM)} + 0.5 V or 2.3 V, whichever is greater; I_{OUT} = 10 mA, C_{IN} = C_{OUT} = 1 μF, unless otherwise noted. V_{EN} = 0.9 V. Typical values are at T_J = +25°C. Min./Max. are for T_J = −40°C and T_J = +125°C respectively (Note 3).

Parameter	Test Conditions		Symbol	Min	Typ	Max	Unit
Operating Input Voltage			V _{IN}	1.8		5.5	V
Output Voltage Accuracy	2.3 V ≤ V _{IN} ≤ 4.2 V I _{OUT} = 0 – 300 mA	V _{OUT(nom)} < 1.5 V	V _{OUT}	−30		+30	mV
	V _{OUT(NOM)} + 0.5 V or 2.3 V ≤ V _{IN} ≤ 5.5 V I _{OUT} = 0 – 300 mA	V _{OUT(nom)} ≥ 1.5 V		−2		+2	%
Line Regulation	V _{OUT} + 0.5 V or 2.3 V ≤ V _{IN} ≤ 5.5 V, I _{OUT} = 10 mA		Reg _{LINE}		400		μV/V
Load Regulation	I _{OUT} = 0 mA to 300 mA		Reg _{LOAD}		12		μV/mA
Load Transient	I _{OUT} = 1 mA to 300 mA or 300 mA to 1 mA in 1 μs, C _{OUT} = 1 μF		Tran _{LOAD}		95		mV
Dropout Voltage (Note 4)	I _{OUT} = 300 mA	V _{OUT} = 2.5 V	V _{DO}		190	350	mV
		V _{OUT} = 2.8 V			175	280	
		V _{OUT} = 2.85 V			175	265	
		V _{OUT} = 3.0 V			170	250	
		V _{OUT} = 3.1 V			165	235	
		V _{OUT} = 3.2 V			165	235	
		V _{OUT} = 3.3 V			155	230	
Output Current Limit	V _{OUT} = 90% V _{OUT(nom)}		I _{CL}		379	500	mA
Ground Current	I _{OUT} = 0 mA		I _Q		25	35	μA
	I _{OUT} = 2 mA		I _{GND}		105		
	I _{OUT} = 300 mA		I _{GND}		250		
Shutdown Current	V _{EN} ≤ 0.4 V, V _{IN} = 5.5 V		I _{DIS}		0.01	1	μA
EN Pin Threshold Voltage High Threshold Low Threshold	V _{EN} Voltage increasing V _{EN} Voltage decreasing		V _{EN_HI} V _{EN_LO}	0.9		0.4	V
EN Pin Input Current	V _{EN} = 5.5 V		I _{EN}		180	500	nA
Turn-on Time	C _{OUT} = 1.0 μF, From assertion of V _{EN} to 98% V _{OUT(NOM)}		t _{ON}		200		μs
Power Supply Rejection Ratio	V _{IN} = 3.6 V, V _{OUT} = 3.1 V I _{OUT} = 150 mA	f = 100 Hz f = 1 kHz f = 10 kHz	PSRR		58 70 55		dB
Output Noise Voltage	V _{IN} = 3.6 V, V _{OUT} = 3.1 V, I _{OUT} = 300 mA f = 100 Hz to 100 kHz		V _N		22		μV _{rms}
Thermal Shutdown Temperature	Temperature increasing from T _J = +25°C		T _{SD}		160		°C
Thermal Shutdown Hysteresis	Temperature falling from T _{SD}		T _{SDH}		20		°C
Active Output Discharge Resistance	V _{EN} < 0.4 V	Version A	R _{DIS}		1.2		kΩ
		Version C			120		Ω

Product parametric performance is indicated in the Electrical Characteristics for the listed test conditions, unless otherwise noted. Product performance may not be indicated by the Electrical Characteristics if operated under different conditions.

3. Performance guaranteed over the indicated operating temperature range by design and/or characterization. Production tested at

T_J = T_A = 25°C. Low duty cycle pulse techniques are used during testing to maintain the junction temperature as close to ambient as possible.

4. Characterized when V_{OUT} falls 100 mV below the regulated voltage at V_{IN} = V_{OUT(NOM)} + 0.5 V.

NCP717

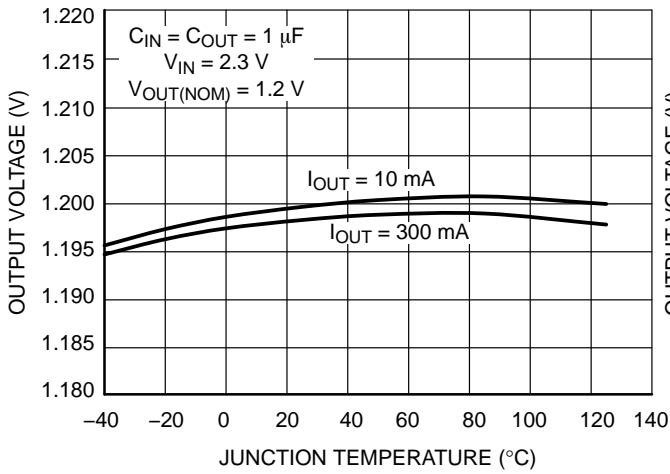

Figure 1. Output Voltage vs. Temperature
V_{OUT} = 1.2 V

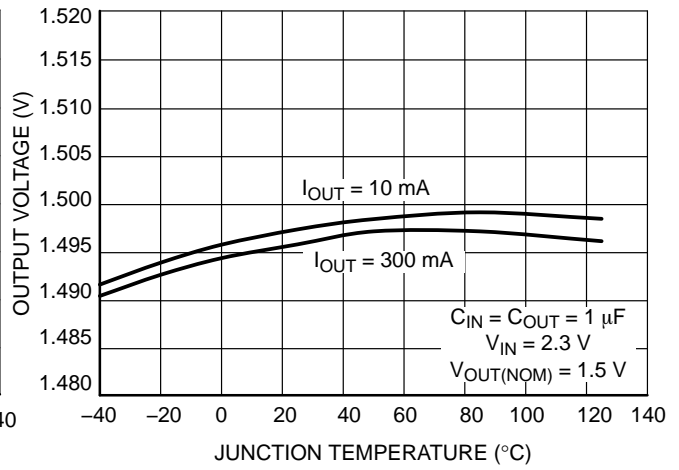

Figure 1. Output Voltage vs. Temperature
V_{OUT} = 1.5 V

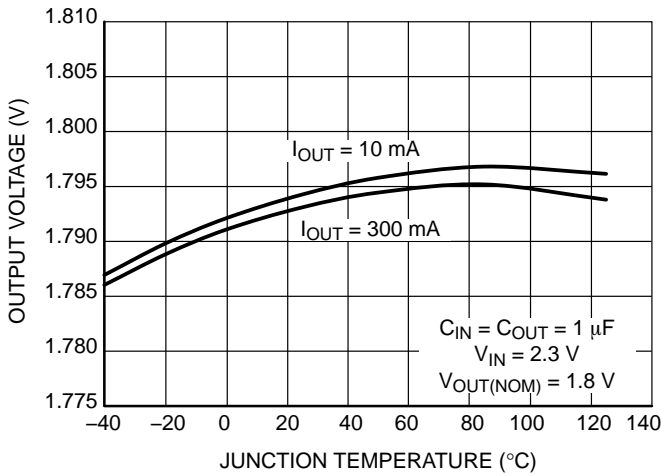

Figure 2. Output Voltage vs. Temperature
V_{OUT} = 1.85 V

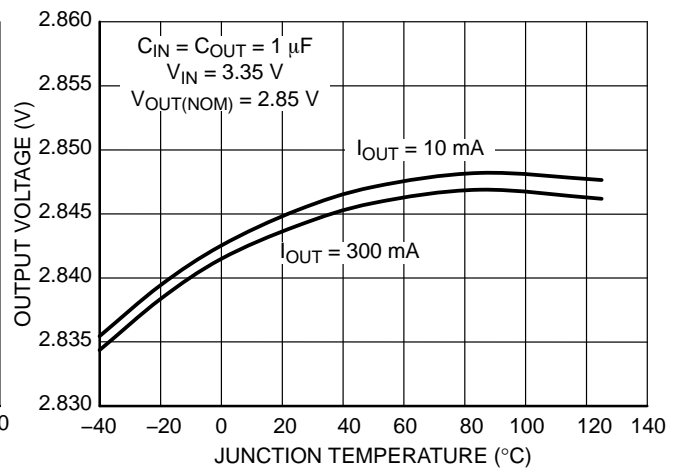

Figure 3. Output Voltage vs. Temperature
V_{OUT} = 2.85 V

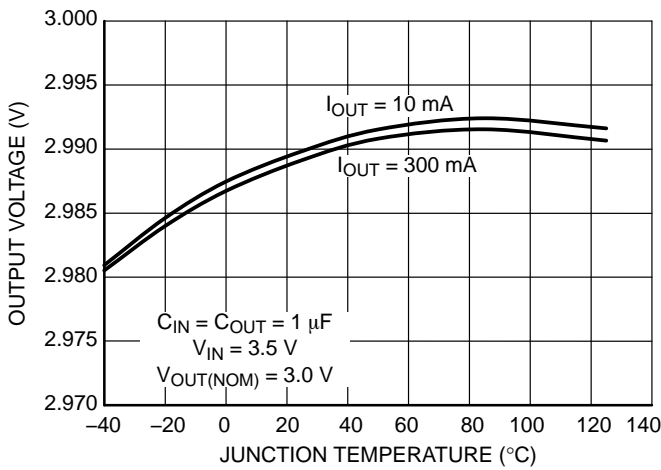

Figure 4. Output Voltage vs. Temperature
V_{OUT} = 3.0 V

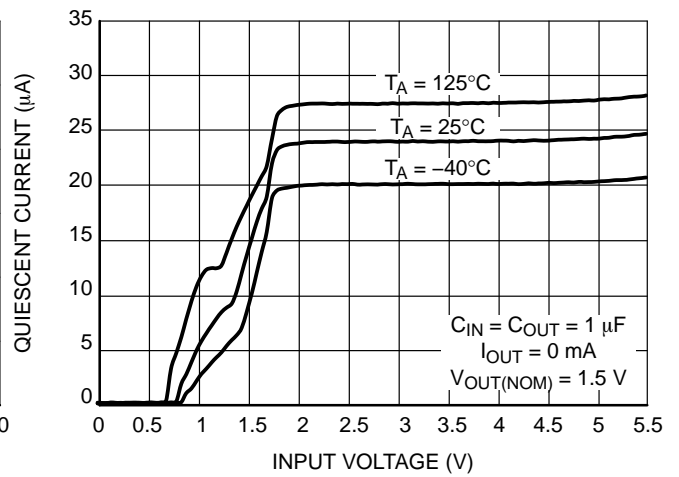

Figure 5. Quiescent Current vs. Temperature
V_{OUT} = 1.5 V

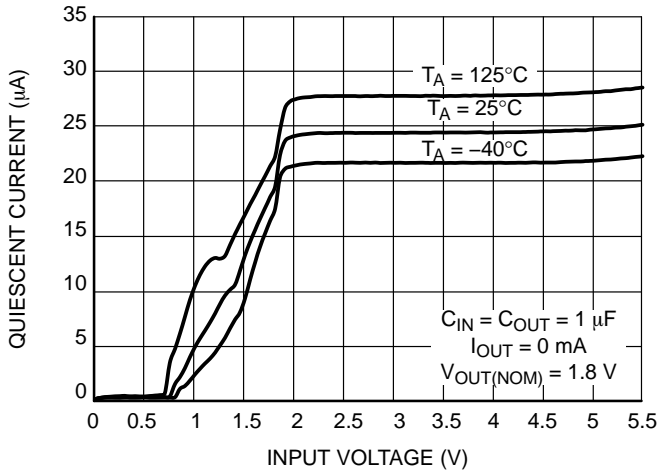

Figure 6. Quiescent Current vs. Temperature
V_{OUT} = 1.8 V

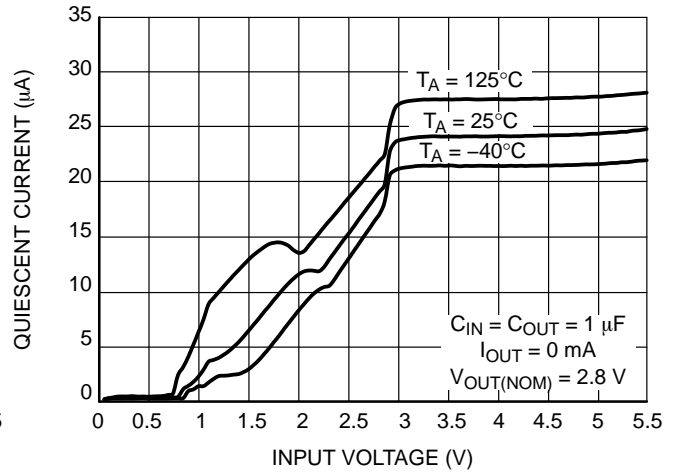

Figure 7. Quiescent Current vs. Temperature
V_{OUT} = 2.8 V

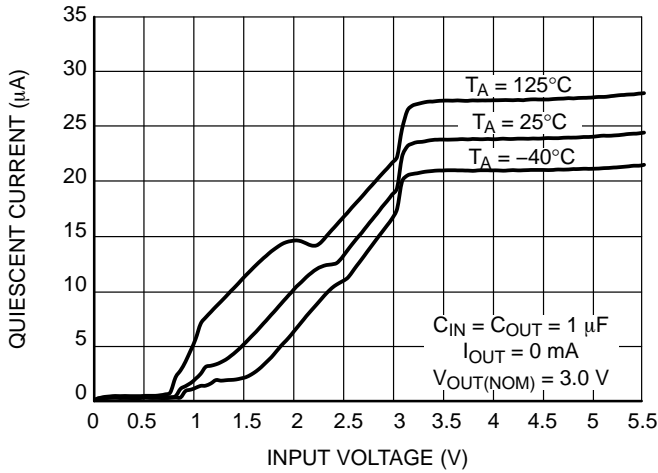

Figure 8. Quiescent Current vs. Temperature
V_{OUT} = 3.0 V

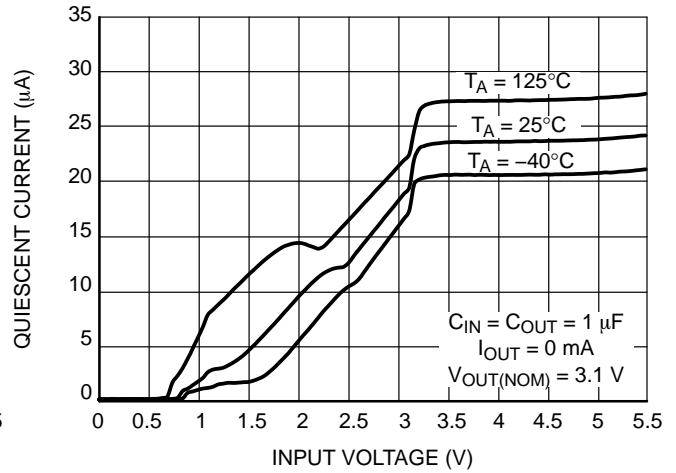

Figure 9. Quiescent Current vs. Temperature
V_{OUT} = 3.1 V

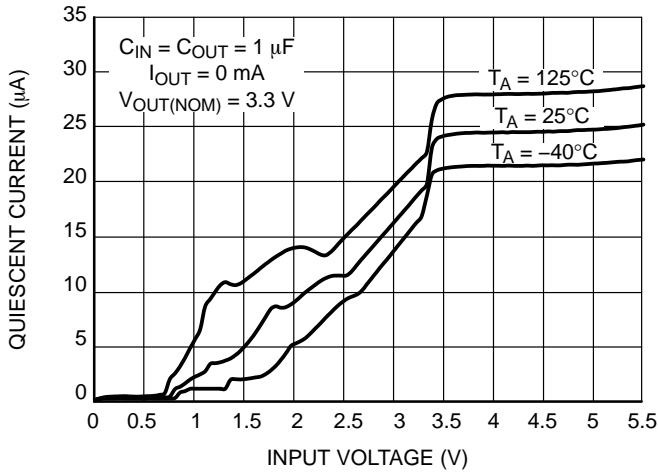

Figure 10. Quiescent Current vs. Temperature
V_{OUT} = 3.3 V

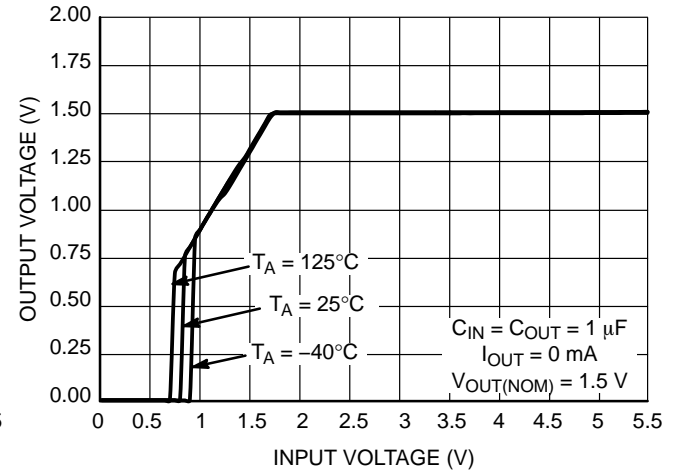

Figure 11. Output Voltage vs. Input Voltage
V_{OUT} = 1.5 V

NCP717

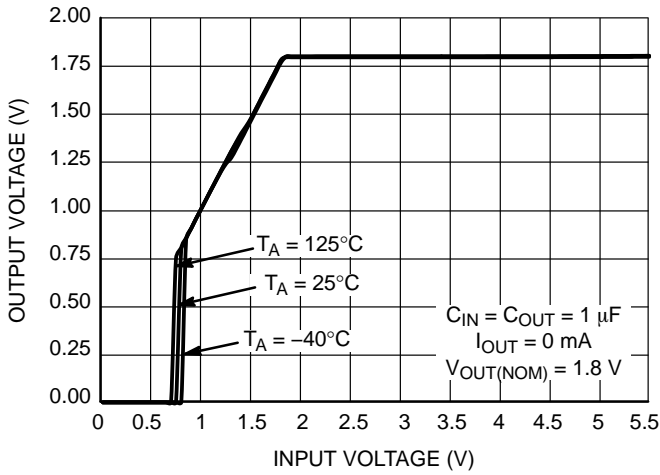

Figure 12. Output Voltage vs. Input Voltage
 $V_{OUT} = 1.8\text{ V}$

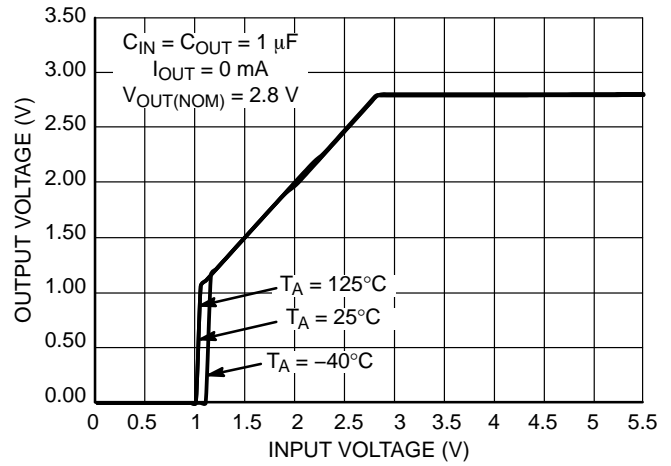

Figure 13. Output Voltage vs. Input Voltage
 $V_{OUT} = 2.8\text{ V}$

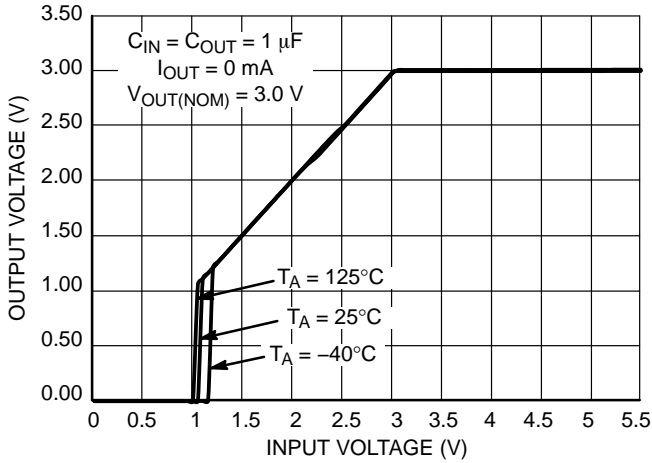

Figure 14. Output Voltage vs. Input Voltage
 $V_{OUT} = 3.0\text{ V}$

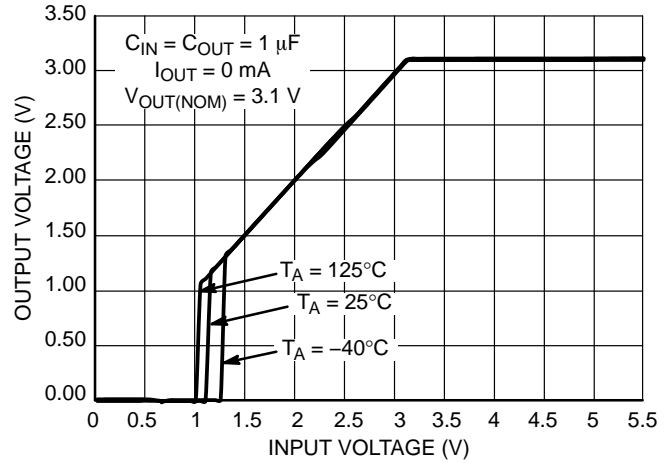

Figure 15. Output Voltage vs. Input Voltage
 $V_{OUT} = 3.1\text{ V}$

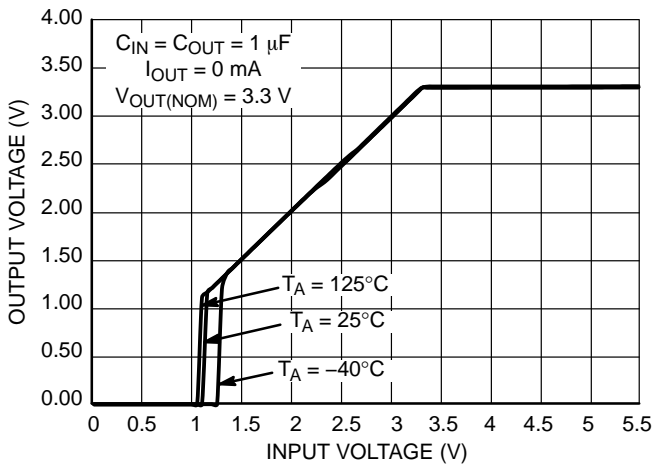

Figure 16. Output Voltage vs. Input Voltage
 $V_{OUT} = 3.3\text{ V}$

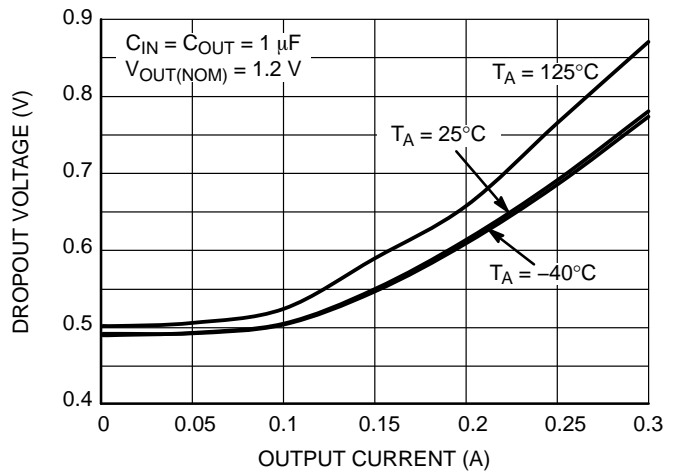

Figure 17. Dropout Voltage vs. Output Current
 $V_{OUT} = 1.2\text{ V}$

NCP717

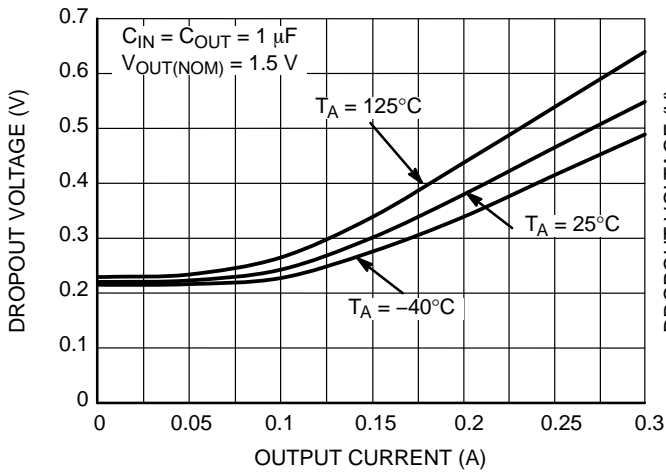

Figure 18. Dropout Voltage vs. Output Current
 $V_{OUT} = 1.5\text{ V}$

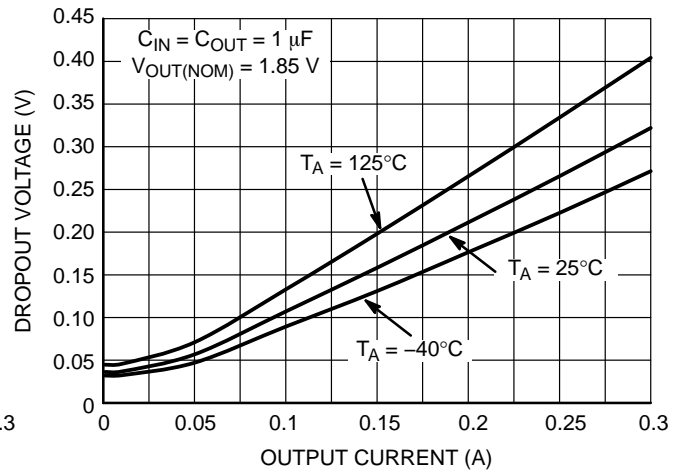

Figure 19. Dropout Voltage vs. Output Current
 $V_{OUT} = 1.85\text{ V}$

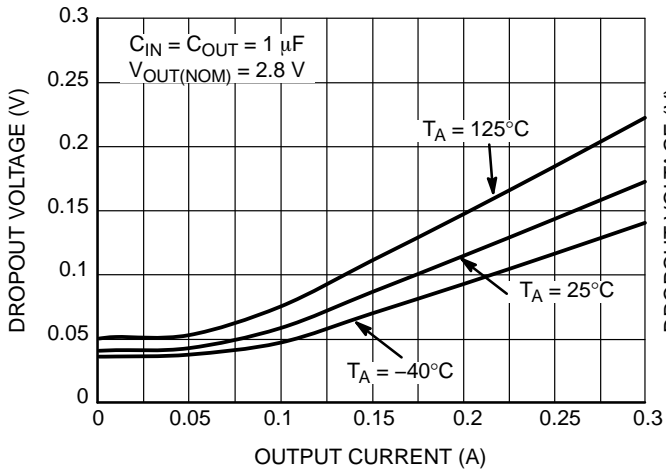

Figure 20. Dropout Voltage vs. Output Current
 $V_{OUT} = 2.8\text{ V}$

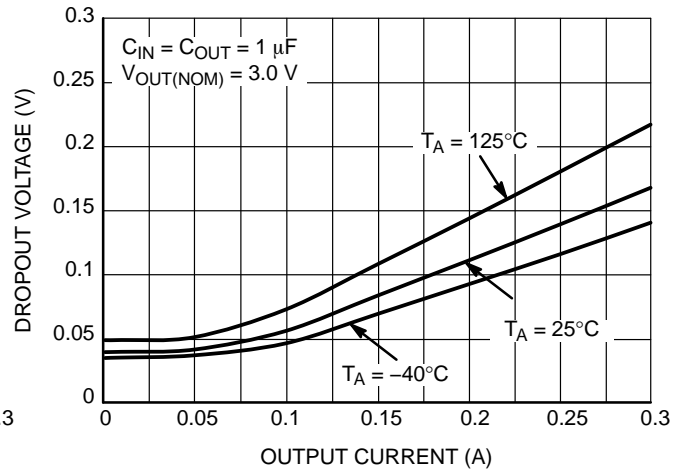

Figure 21. Dropout Voltage vs. Output Current
 $V_{OUT} = 3.0\text{ V}$

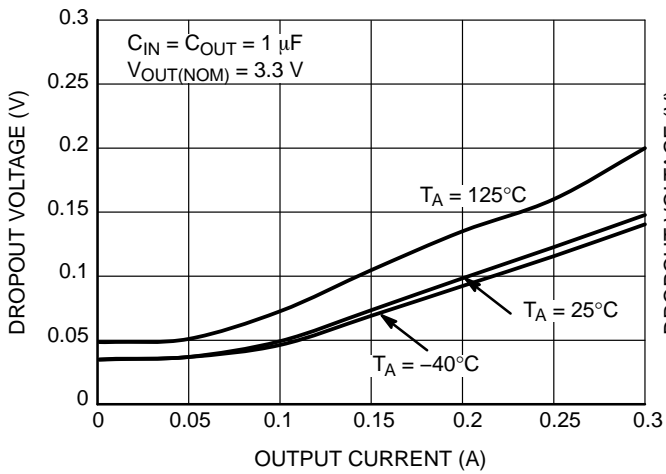

Figure 22. Dropout Voltage vs. Output Current
 $V_{OUT} = 3.1\text{ V}$

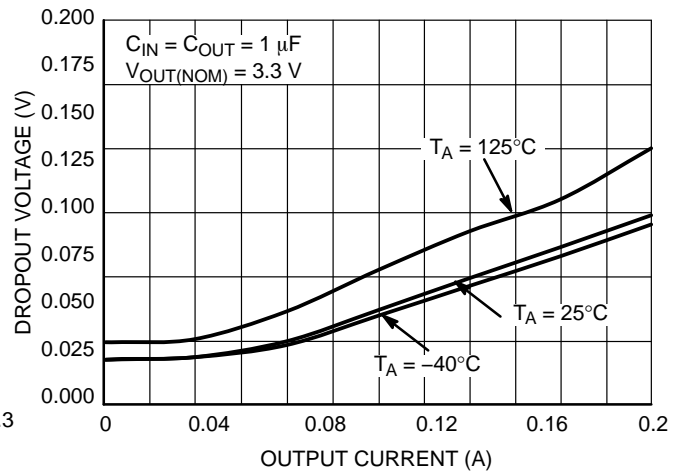

Figure 23. Dropout Voltage vs. Output Current
 $V_{OUT} = 3.3\text{ V}$

NCP717

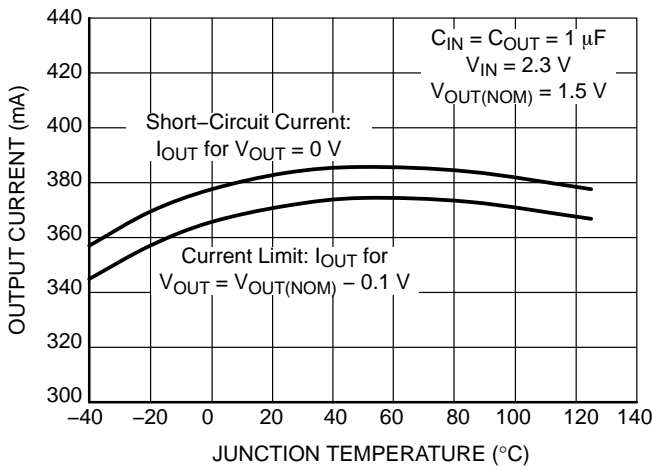

Figure 24. Short-Circuit Limit vs. Temperature
V_{OUT} = 1.5 V

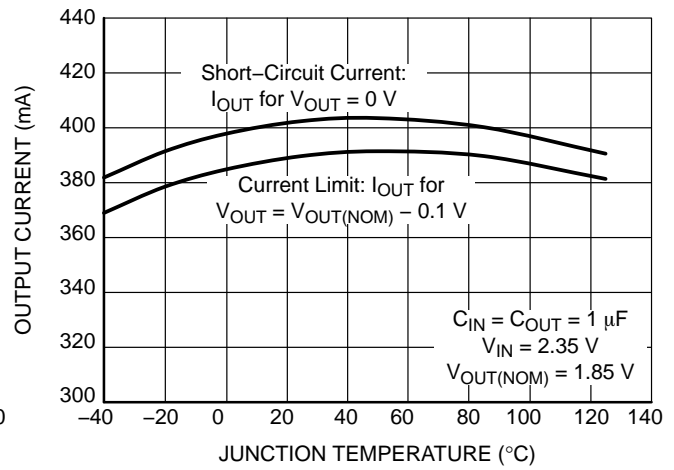

Figure 25. Short-Circuit Limit vs. Temperature
V_{OUT} = 1.85 V

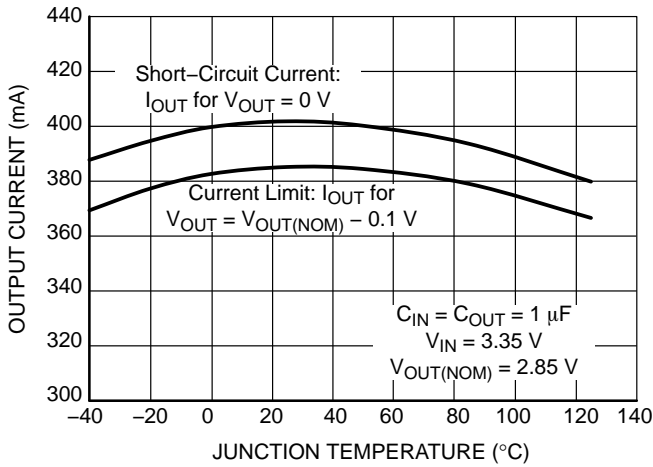

Figure 26. Short-Circuit Limit vs. Temperature
V_{OUT} = 2.85 V

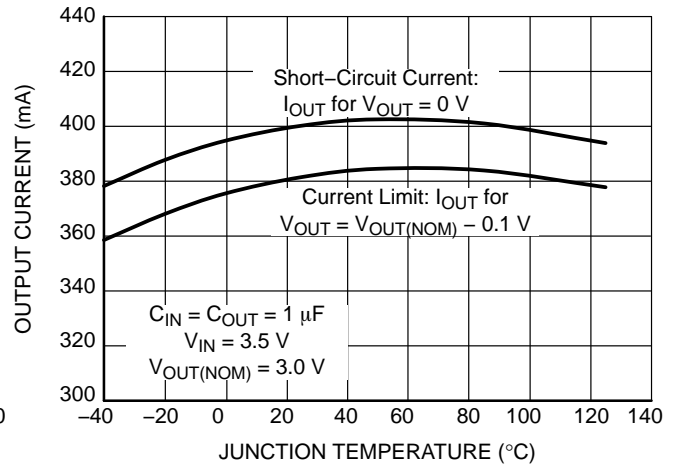

Figure 27. Short-Circuit Limit vs. Temperature
V_{OUT} = 3.0 V

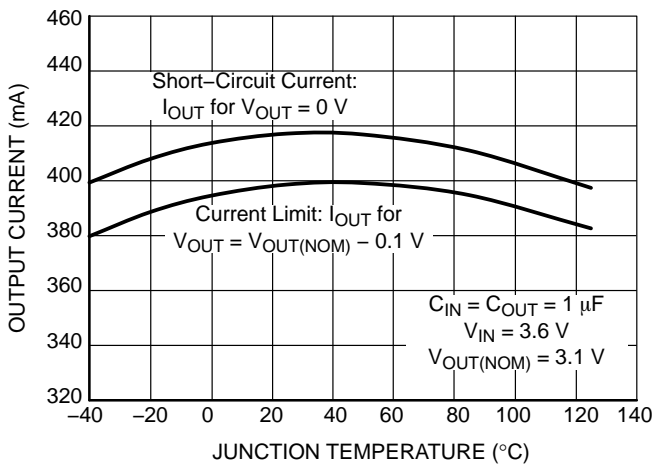

Figure 28. Short-Circuit Limit vs. Temperature
V_{OUT} = 3.1 V

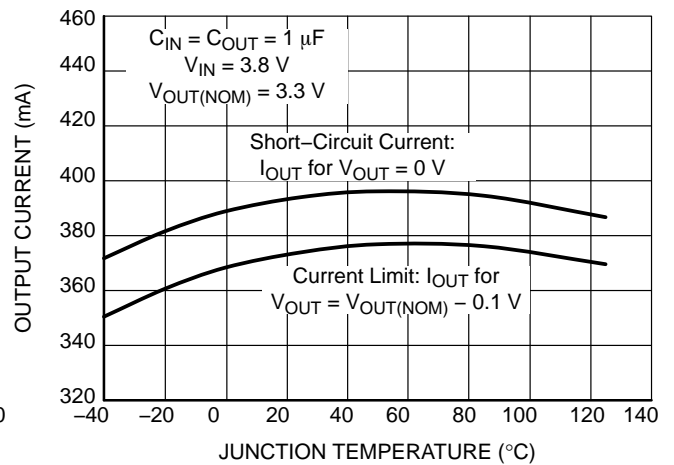

Figure 29. Short-Circuit Limit vs. Temperature
V_{OUT} = 3.3 V

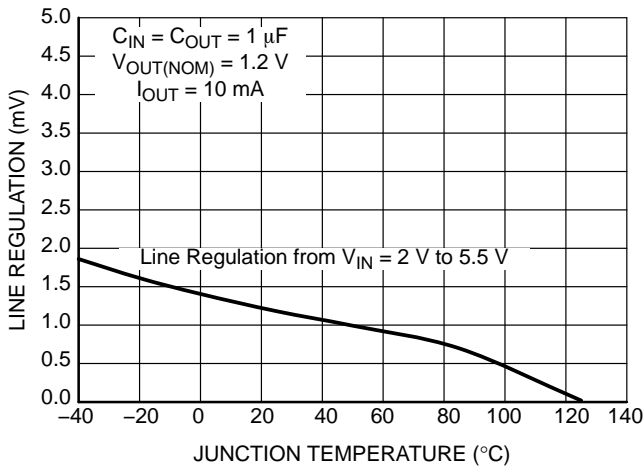

Figure 30. Line Regulation vs. Temperature
V_{OUT} = 1.2 V

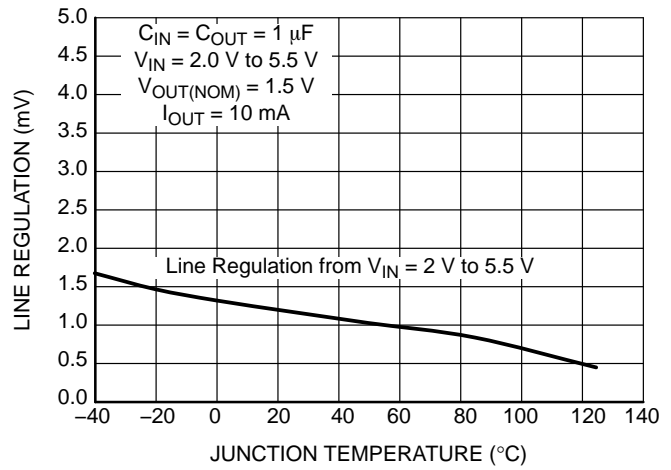

Figure 31. Line Regulation vs. Temperature
V_{OUT} = 1.5 V

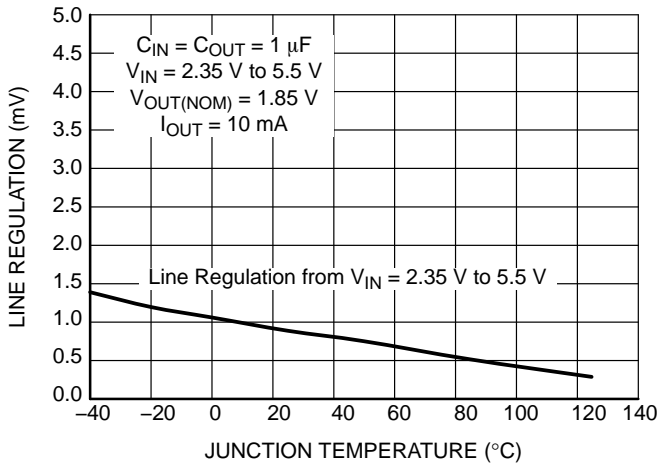

Figure 32. Line Regulation vs. Temperature
V_{OUT} = 1.85 V

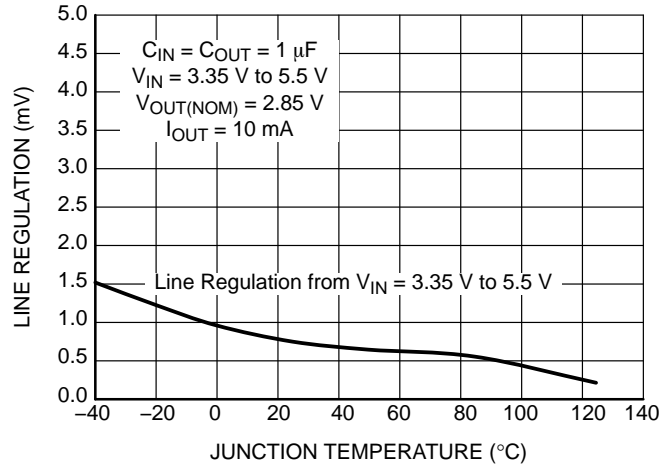

Figure 33. Line Regulation vs. Temperature
V_{OUT} = 2.85 V

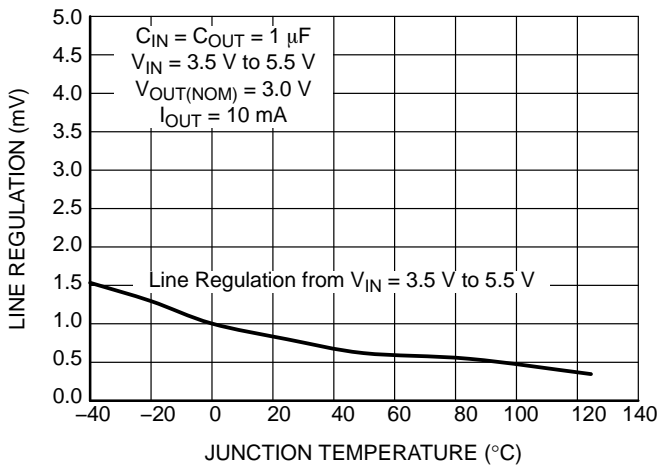

Figure 34. Line Regulation vs. Temperature
V_{OUT} = 3.0 V

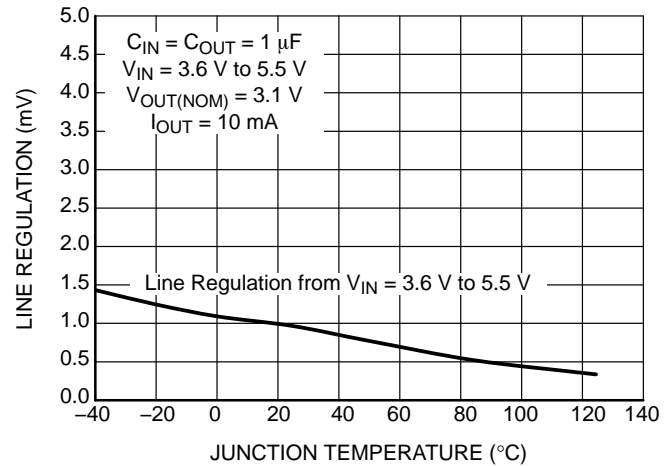

Figure 35. Line Regulation vs. Temperature
V_{OUT} = 3.1 V

NCP717

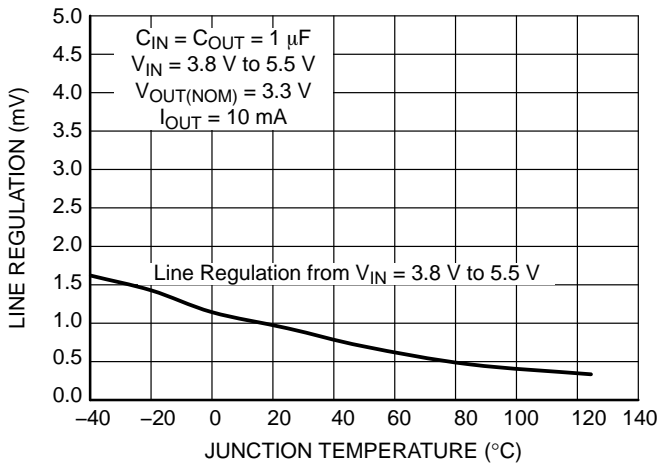

Figure 36. Line Regulation vs. Temperature
 $V_{OUT} = 3.3 \text{ V}$

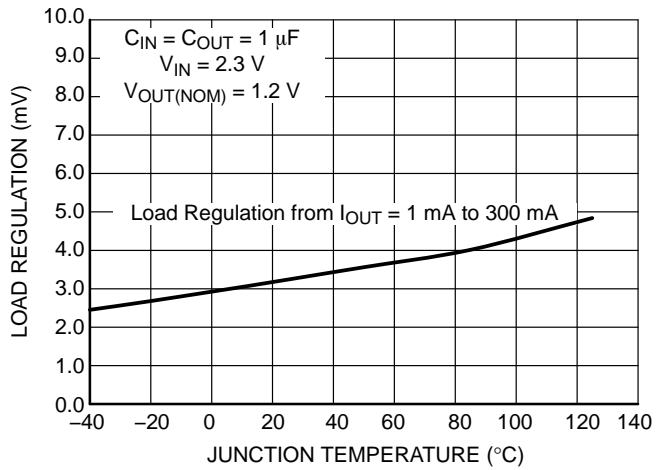

Figure 37. Load Regulation vs. Temperature
 $V_{OUT} = 1.2 \text{ V}$

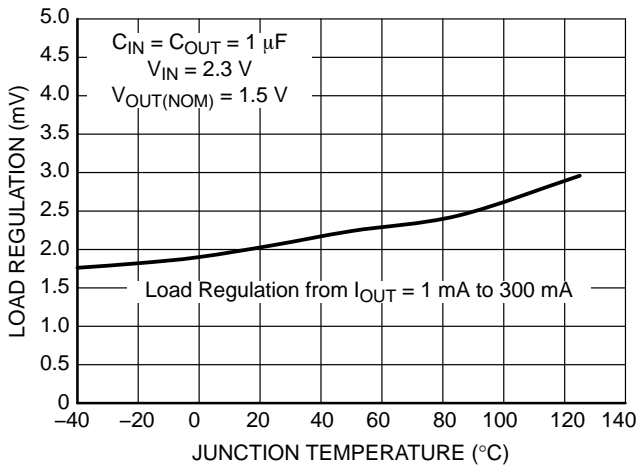

Figure 38. Load Regulation vs. Temperature
 $V_{OUT} = 1.5 \text{ V}$

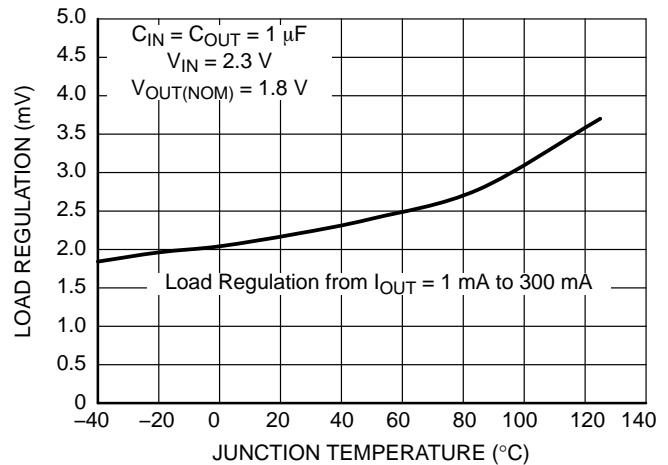

Figure 39. Load Regulation vs. Temperature
 $V_{OUT} = 1.8 \text{ V}$

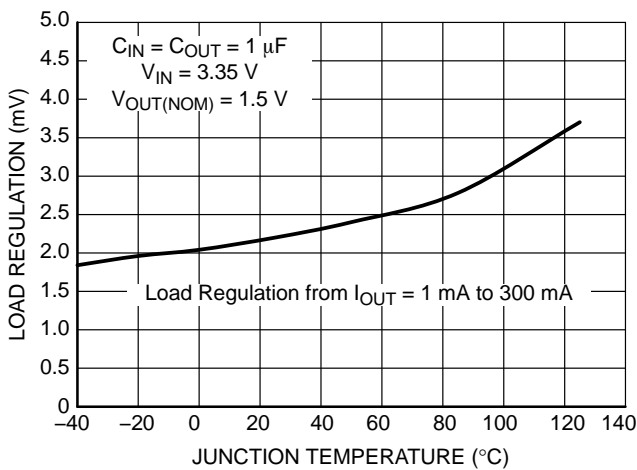

Figure 40. Load Regulation vs. Temperature
 $V_{OUT} = 2.85 \text{ V}$

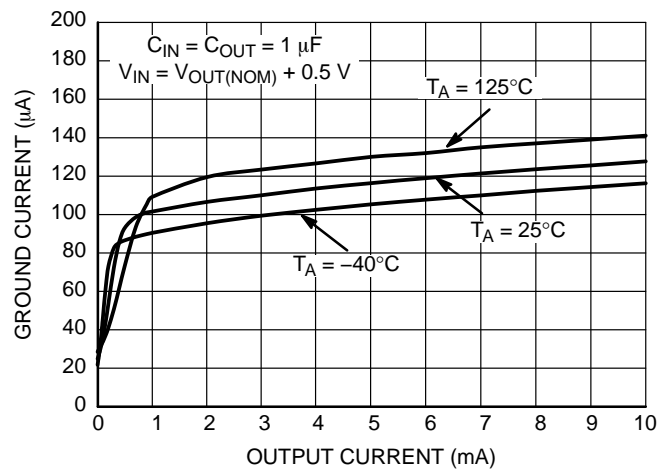

Figure 41. Ground Current vs. Output Current

NCP717

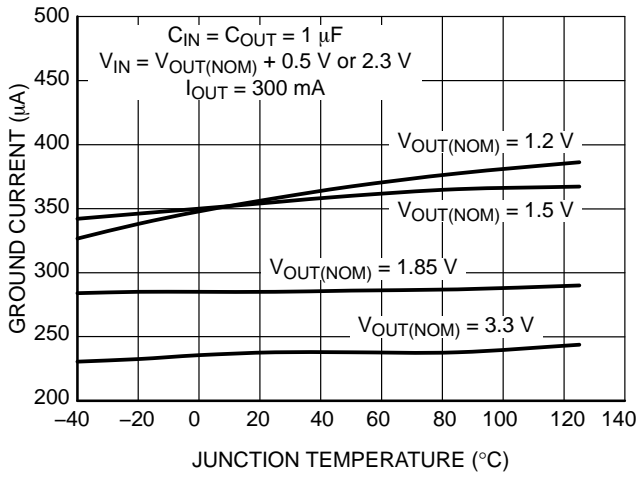

Figure 42. Ground Current vs. Temperature

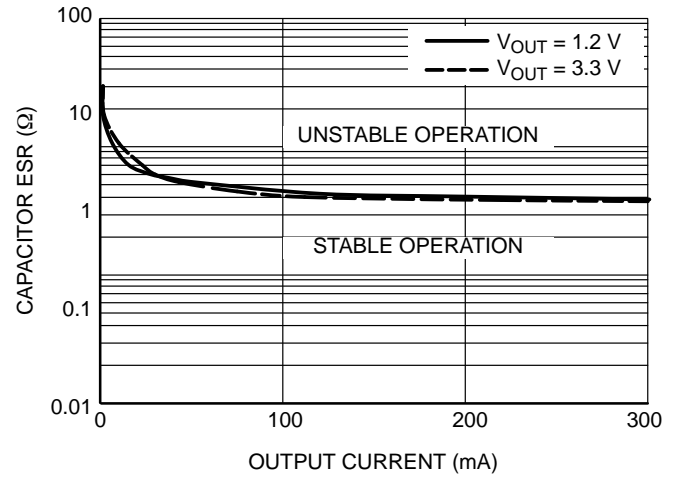

Figure 43. Stability vs. Output Capacitor ESR

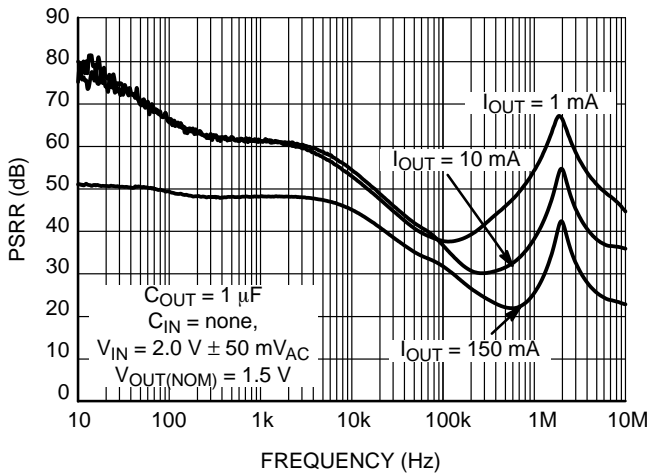

Figure 44. PSRR vs. Frequency
 $V_{OUT} = 1.5 V$

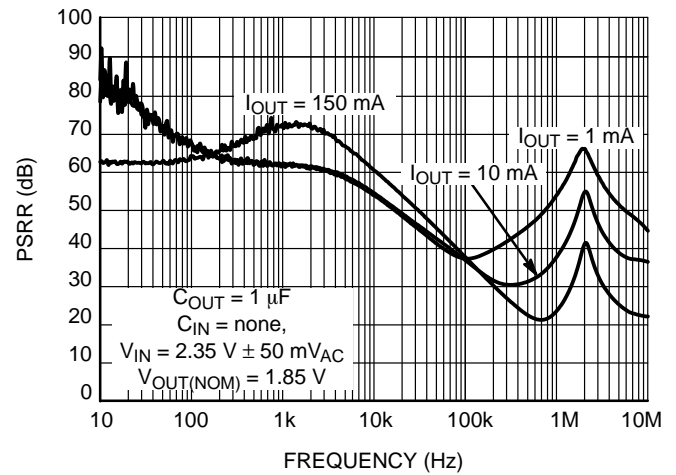

Figure 45. PSRR vs. Frequency
 $V_{OUT} = 1.85 V$

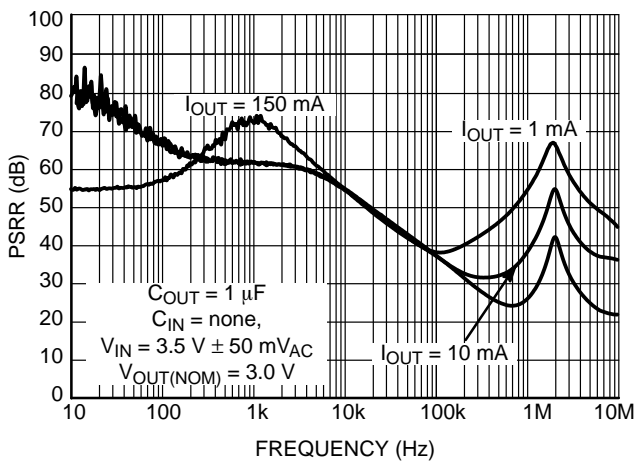

Figure 46. PSRR vs. Frequency
 $V_{OUT} = 3.0 V$

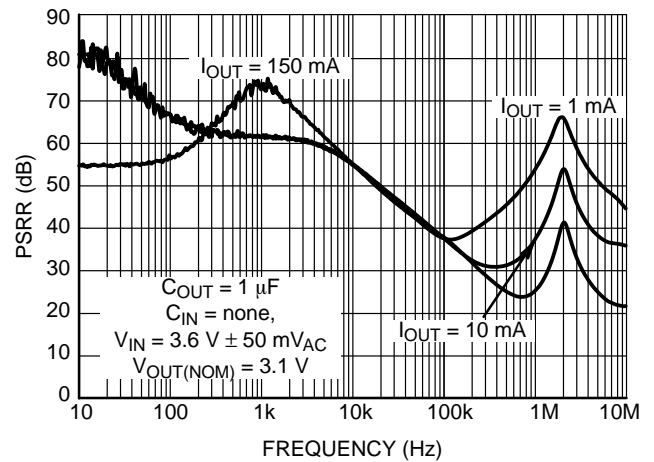

Figure 47. PSRR vs. Frequency
 $V_{OUT} = 3.1 V$

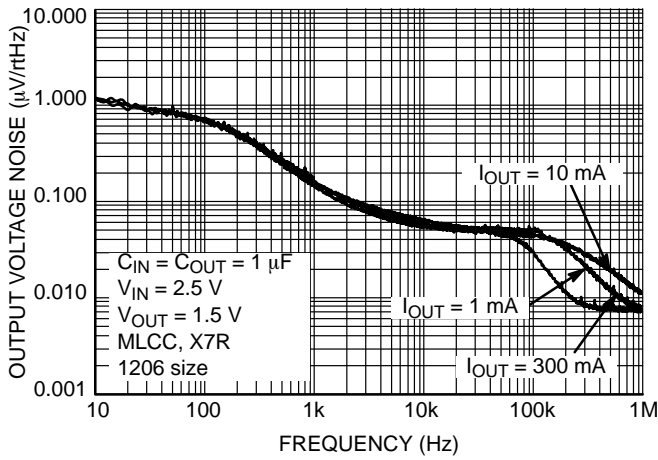

Figure 48. Output Noise Density vs. Frequency
V_{OUT} = 1.5 V

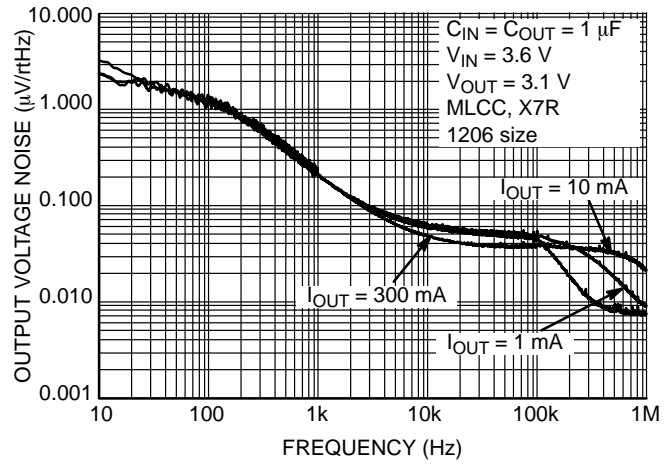

Figure 49. Output Noise Density vs. Frequency
V_{OUT} = 3.1 V

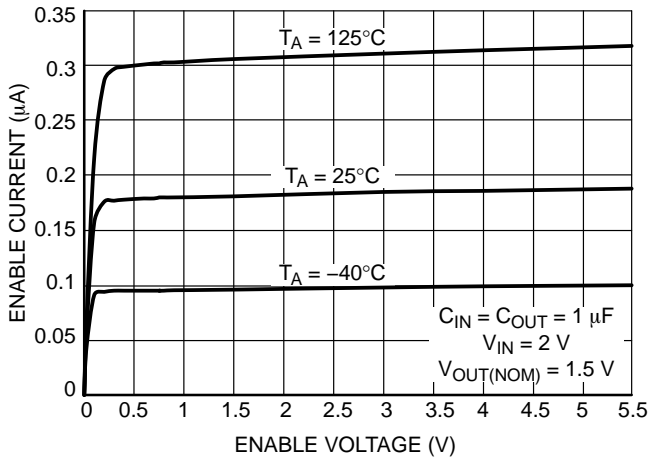

Figure 50. Enable Input Current vs. Enable Voltage

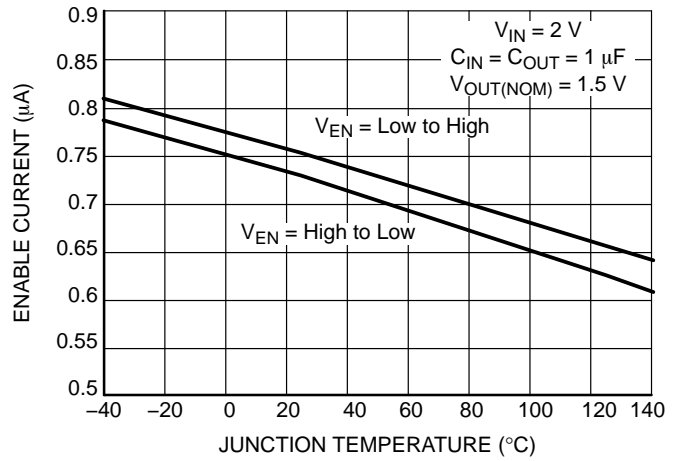

Figure 51. Enable Threshold Voltage vs. Temperature

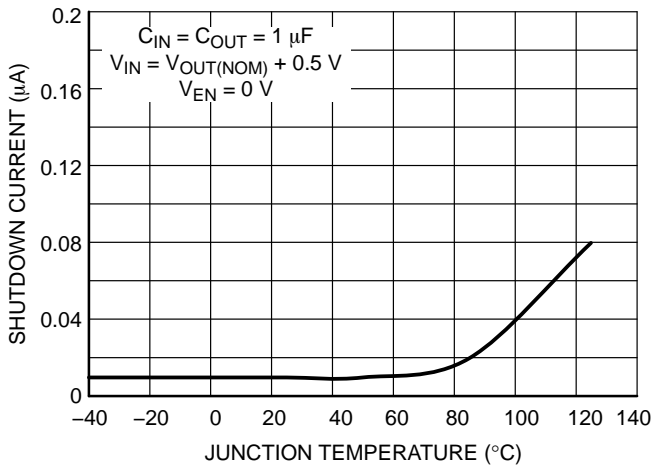

Figure 52. Shutdown Current vs. Temperature

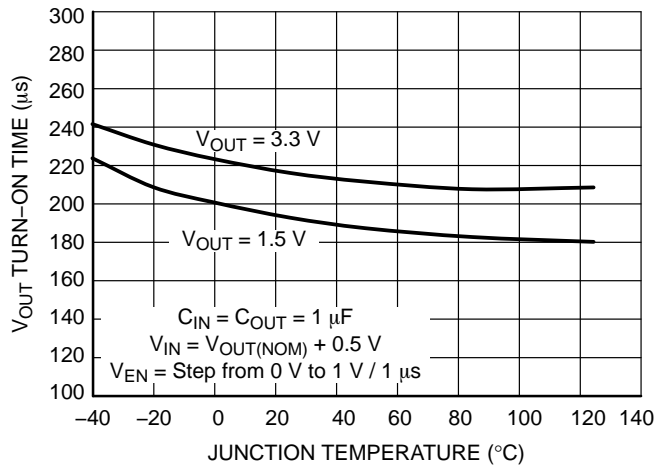

Figure 53. V_{OUT} Turn-on Time vs. Temperature

APPLICATIONS INFORMATION

The NCP717 is a high performance, small package size, 300 mA LDO voltage regulator. This device delivers very good noise and dynamic performance. Thanks to its adaptive ground current feature the device consumes only 25 μ A of quiescent current at no-load condition. The regulator features very-low noise of 22 μ VRMS, PSRR of typ. 70 dB at 1 kHz and very good load/line transient response. The device is an ideal choice for space constrained portable applications.

A logic EN input provides ON/OFF control of the output voltage. When the EN is low the device consumes as low as typ. 10 nA from the IN pin.

The device is fully protected in case of output overload, output short circuit condition and overheating, assuring a very robust design.

Input Capacitor Selection (C_{IN})

It is recommended to connect a minimum of 1 μ F Ceramic X5R or X7R capacitor close to the IN pin of the device. Larger input capacitors may be necessary if fast and large load transients are encountered in the application. There is no requirement for the min./max. ESR of the input capacitor but it is recommended to use ceramic capacitors for their low ESR and ESL.

Output Capacitor Selection (C_{OUT})

The NCP717 is designed to be stable with small 1.0 μ F and larger ceramic capacitors on the output. The minimum effective output capacitance for which the LDO remains stable is 100 nF. The safety margin is provided to account for capacitance variations due to DC bias voltage, temperature, initial tolerance. There is no requirement for the minimum value of Equivalent Series Resistance (ESR) for the C_{OUT} but the maximum value of ESR should be less than 700 m Ω .

Larger output capacitors could be used to improve the load transient response or high frequency PSRR characteristics. It is not recommended to use tantalum capacitors on the output due to their large ESR. The equivalent series resistance of tantalum capacitors is also strongly dependent on the temperature, increasing at low temperature. The tantalum capacitors are generally more costly than ceramic capacitors.

No-load Operation

The regulator remains stable and regulates the output voltage properly within the $\pm 2\%$ tolerance limits even with no external load applied to the output.

Enable Operation

The NCP717 uses the EN pin to enable/disable its output and to control the active discharge function. If the EN pin voltage is < 0.4 V the device is guaranteed to be disabled. The pass transistor is turned – off so that there is virtually no current flow between the IN and OUT. In case of the option equipped with active discharge – the active discharge transistor is turned–on and the output voltage V_{OUT} is pulled

to GND through a 1.2 k Ω resistor (A version) or 120 Ω (C version). In the disable state the device consumes as low as typ. 10 nA from the V_{IN}. If the EN pin voltage > 0.9 V the device is guaranteed to be enabled. The NCP717 regulates the output voltage and the active discharge transistor is turned–off. The EN pin has an internal pull–down current source with typ. value of 180 nA which assures that the device is turned–off when the EN pin is not connected. A build in 56 mV of hysteresis and deglitch time in the EN block prevents from periodic on/off oscillations that can occur due to noise on EN line. In the case that the EN function isn't required the EN pin should be tied directly to IN.

Reverse Current

The PMOS pass transistor has an inherent body diode which will be forward biased in the case that V_{OUT} $>$ V_{IN}. Due to this fact in cases where the extended reverse current condition is anticipated the device may require additional external protection.

Output Current Limit

Output Current is internally limited within the IC to a typical 379 mA. The NCP717 will source this amount of current measured with the output voltage 100 mV lower than the nominal V_{OUT}. If the Output Voltage is directly shorted to ground (V_{OUT} = 0 V), the short circuit protection will limit the output current to 390 mA (typ). The current limit and short circuit protection will work properly up to V_{IN} = 5.5 V at T_A = 25°C. There is no limitation for the short circuit duration.

Thermal Shutdown

When the die temperature exceeds the Thermal Shutdown threshold (TSD – 160°C typical), Thermal Shutdown event is detected and the device is disabled. The IC will remain in this state until the die temperature decreases below the Thermal Shutdown Reset threshold (TSDU – 140°C typical). Once the IC temperature falls below the 140°C the LDO is enabled again. The thermal shutdown feature provides protection from a catastrophic device failure due to accidental overheating. This protection is not intended to be used as a substitute for proper heat sinking.

Power Dissipation

As power dissipated in the NCP717 increases, it might become necessary to provide some thermal relief. The maximum power dissipation supported by the device is dependent upon board design and layout. Mounting pad configuration on the PCB, the board material, and the ambient temperature affect the rate of junction temperature rise for the part. The maximum power dissipation the NCP717 can handle is given by:

$$P_{D(MAX)} = \frac{[125 - T_A]}{\theta_{JA}} \quad (\text{eq. 1})$$

NCP717

For reliable operation junction temperature should be limited to +125°C.

The power dissipated by the NCP717 for given application conditions can be calculated as follows:

$$P_{D(MAX)} = V_{IN}I_{GND} + I_{OUT}(V_{IN} - V_{OUT}) \quad (\text{eq. 2})$$

Figure 54 shows the typical values of θ_{JA} vs. heat spreading area.

Load Regulation

The NCP717 features very good load regulation of typical 3.6 mV in the 0 mA to 300 mA range. In order to achieve this very good load regulation a special attention to PCB design is necessary. The trace resistance from the OUT pin to the

point of load can easily approach 100 m Ω which will cause a 68 mV voltage drop at full load current, deteriorating the excellent load regulation.

Line Regulation

The IC features very good line regulation of 0.4 mV/V measured from $V_{IN} = V_{OUT} + 0.5 \text{ V}$ to 5.5 V.

Power Supply Rejection Ratio

At low frequencies the PSRR is mainly determined by the feedback open-loop gain. At higher frequencies in the range 100 kHz – 10 MHz it can be tuned by the selection of C_{OUT} capacitor and proper PCB layout.

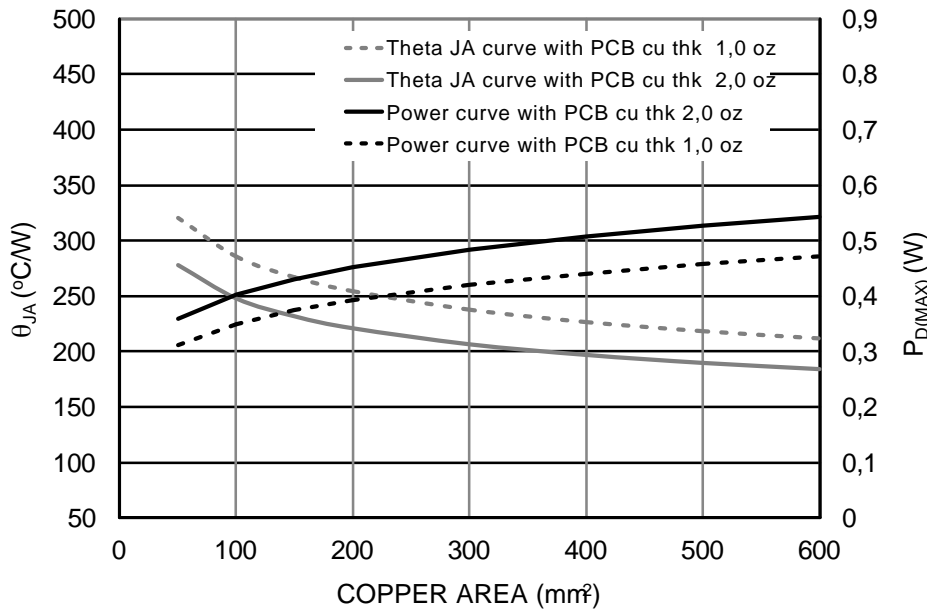

Figure 54. Thermal Parameters vs. Copper Area

Output Noise

The IC is designed for very-low output voltage noise. The typical noise performance of 22 μV_{RMS} makes the device suitable for noise sensitive applications.

Internal Soft Start

The Internal Soft-Start circuitry will limit the inrush current during the LDO turn-on phase. Please refer to typical characteristics section for typical inrush current values. The soft-start function prevents from any output

voltage overshoots and assures monotonic ramp-up of the output voltage.

PCB Layout Recommendations

To obtain good transient performance and good regulation characteristics place C_{IN} and C_{OUT} capacitors close to the device pins and make the PCB traces wide. In order to minimize the solution size use 0402 capacitors. Larger copper area connected to the pins will also improve the device thermal resistance. The actual power dissipation can be calculated by the formula given in Equation 2.

NCP717

ORDERING INFORMATION

Device	Voltage Option	Marking	Marking Rotation	Option	Package	Shipping [†]
NCP717AMX150TCG	1.5 V	R	0°	With active output discharge function $R_{DIS}=1.2\text{ k}\Omega$	XDFN4 (Pb-Free)	3000 / Tape & Reel
NCP717AMX180TCG	1.8 V	T	0°			
NCP717AMX185TCG	1.85 V	V	0°			
NCP717AMX190TCG	1.9 V	6	0°			
NCP717AMX250TCG	2.5 V	T	180°			
NCP717AMX280TCG	2.8 V	Y	0°			
NCP717AMX285TCG	2.85 V	2	0°			
NCP717AMX300TCG	3.0 V	3	0°			
NCP717AMX310TCG	3.1 V	4	0°			
NCP717AMX330TCG	3.3 V	5	0°			
NCP717BMX150TCG	1.5 V	R	90°	Without active output discharge function		
NCP717BMX180TCG	1.8 V	T	90°			
NCP717BMX185TCG	1.85 V	V	90°			
NCP717BMX190TCG	1.9 V	6	90°			
NCP717BMX250TCG	2.5 V	T	270°			
NCP717BMX280TCG	2.8 V	Y	90°			
NCP717BMX285TCG	2.85 V	2	90°			
NCP717BMX300TCG	3.0 V	3	90°			
NCP717BMX310TCG	3.1 V	4	90°			
NCP717BMX330TCG	3.3 V	5	90°			
NCP717CMX135TCG	1.35 V	D	270°	With active output discharge function $R_{DIS}=120\ \Omega$		
NCP717CMX150TCG	1.5 V	L	270°			
NCP717CMX180TCG	1.8 V	P	270°			
NCP717CMX185TCG	1.85 V	Q	270°			
NCP717CMX190TCG	1.9 V	R	270°			
NCP717CMX220TCG	2.2 V	A	270°			
NCP717CMX250TCG	2.5 V	V	270°			
NCP717CMX280TCG	2.8 V	Y	270°			
NCP717CMX285TGB	2.85 V	2	270°			
NCP717CMX285TCG	2.85 V	2	270°			
NCP717CMX300TCG	3.0 V	3	270°			
NCP717CMX310TCG	3.1 V	4	270°			
NCP717CMX320TCG	3.2 V	5	270°			
NCP717CMX330TGB	3.3 V	6	270°			
NCP717CMX330TCG	3.3 V	6	270°			

[†]For information on tape and reel specifications, including part orientation and tape sizes, please refer to our Tape and Reel Packaging Specifications Brochure, BRD8011/D.

Bluetooth is a registered trademark of Bluetooth SIG.
ZigBee is a registered trademark of ZigBee Alliance.

MECHANICAL CASE OUTLINE PACKAGE DIMENSIONS



XDFN4 1.0x1.0, 0.65P
CASE 711AJ
ISSUE C

DATE 08 MAR 2022



NOTES:

1. DIMENSIONING AND TOLERANCING PER ASME Y14.5M, 1994.
2. CONTROLLING DIMENSION: MILLIMETERS
3. DIMENSION *b* APPLIES TO THE PLATED TERMINALS AND IS MEASURED BETWEEN 0.15 AND 0.20 FROM THE TERMINAL TIPS.
4. COPLANARITY APPLIES TO THE EXPOSED PAD AS WELL AS THE TERMINALS.

DIM	MILLIMETERS		
	MIN	NOM	MAX
A	0.33	0.38	0.43
A1	0.00	---	0.05
A3	0.10 REF		
<i>b</i>	0.15	0.20	0.25
<i>b</i> 2	0.02	0.07	0.12
D	0.90	1.00	1.10
D2	0.43	0.48	0.53
E	0.90	1.00	1.10
<i>e</i>	0.65 BSC		
L	0.20		0.30
L2	0.07		0.17

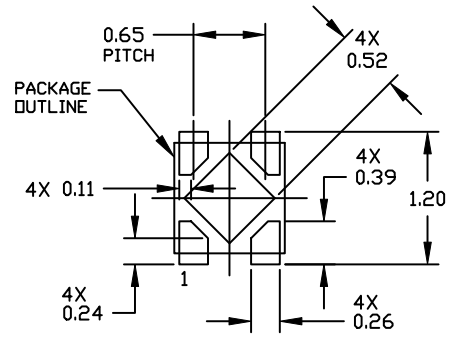
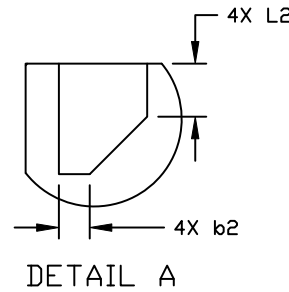
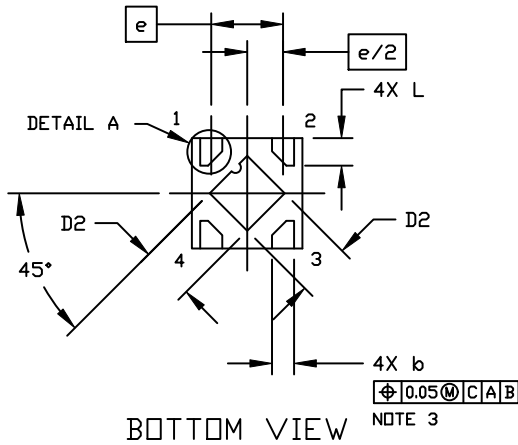

**RECOMMENDED
MOUNTING FOOTPRINT**

* FOR ADDITIONAL INFORMATION ON OUR Pb-FREE STRATEGY AND SOLDERING DETAILS, PLEASE DOWNLOAD THE ONSEMI SOLDERING AND MOUNT TECHNIQUES REFERENCE MANUAL, SOLDERRM/D

GENERIC MARKING DIAGRAM*

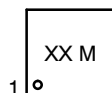

XX = Specific Device Code
M = Date Code

*This information is generic. Please refer to device data sheet for actual part marking. Pb-Free indicator, "G" or microdot "•", may or may not be present. Some products may not follow the Generic Marking.

DOCUMENT NUMBER:	98AON67179E	Electronic versions are uncontrolled except when accessed directly from the Document Repository. Printed versions are uncontrolled except when stamped "CONTROLLED COPY" in red.
DESCRIPTION:	XDFN4, 1.0X1.0, 0.65P	PAGE 1 OF 1

onsemi and ONSEMI are trademarks of Semiconductor Components Industries, LLC dba onsemi or its subsidiaries in the United States and/or other countries. onsemi reserves the right to make changes without further notice to any products herein. onsemi makes no warranty, representation or guarantee regarding the suitability of its products for any particular purpose, nor does onsemi assume any liability arising out of the application or use of any product or circuit, and specifically disclaims any and all liability, including without limitation special, consequential or incidental damages. onsemi does not convey any license under its patent rights nor the rights of others.

onsemi, **Onsemi**, and other names, marks, and brands are registered and/or common law trademarks of Semiconductor Components Industries, LLC dba "**onsemi**" or its affiliates and/or subsidiaries in the United States and/or other countries. **onsemi** owns the rights to a number of patents, trademarks, copyrights, trade secrets, and other intellectual property. A listing of **onsemi**'s product/patent coverage may be accessed at www.onsemi.com/site/pdf/Patent-Marking.pdf. **onsemi** reserves the right to make changes at any time to any products or information herein, without notice. The information herein is provided "as-is" and **onsemi** makes no warranty, representation or guarantee regarding the accuracy of the information, product features, availability, functionality, or suitability of its products for any particular purpose, nor does **onsemi** assume any liability arising out of the application or use of any product or circuit, and specifically disclaims any and all liability, including without limitation special, consequential or incidental damages. Buyer is responsible for its products and applications using **onsemi** products, including compliance with all laws, regulations and safety requirements or standards, regardless of any support or applications information provided by **onsemi**. "Typical" parameters which may be provided in **onsemi** data sheets and/or specifications can and do vary in different applications and actual performance may vary over time. All operating parameters, including "Typicals" must be validated for each customer application by customer's technical experts. **onsemi** does not convey any license under any of its intellectual property rights nor the rights of others. **onsemi** products are not designed, intended, or authorized for use as a critical component in life support systems or any FDA Class 3 medical devices or medical devices with a same or similar classification in a foreign jurisdiction or any devices intended for implantation in the human body. Should Buyer purchase or use **onsemi** products for any such unintended or unauthorized application, Buyer shall indemnify and hold **onsemi** and its officers, employees, subsidiaries, affiliates, and distributors harmless against all claims, costs, damages, and expenses, and reasonable attorney fees arising out of, directly or indirectly, any claim of personal injury or death associated with such unintended or unauthorized use, even if such claim alleges that **onsemi** was negligent regarding the design or manufacture of the part. **onsemi** is an Equal Opportunity/Affirmative Action Employer. This literature is subject to all applicable copyright laws and is not for resale in any manner.

ADDITIONAL INFORMATION

TECHNICAL PUBLICATIONS:

Technical Library: www.onsemi.com/design/resources/technical-documentation
onsemi Website: www.onsemi.com

ONLINE SUPPORT: www.onsemi.com/support

For additional information, please contact your local Sales Representative at www.onsemi.com/support/sales

Looking for pricing, stock, or lifecycle information?

Click below to explore more details on WIN SOURCE:

 [View NCP717AMX280TCG on WIN SOURCE](#)

 [ON Semiconductor](#) Information

Optimize Your Supply Chain with WIN SOURCE Solutions

-  Global Sourcing Solution
-  Obsolete Management
-  Cost Control Management
-  Shortage Management
-  Alternative Solution
-  Excess Inventory Management